

# Low-Noise 220-Megacycle Converter

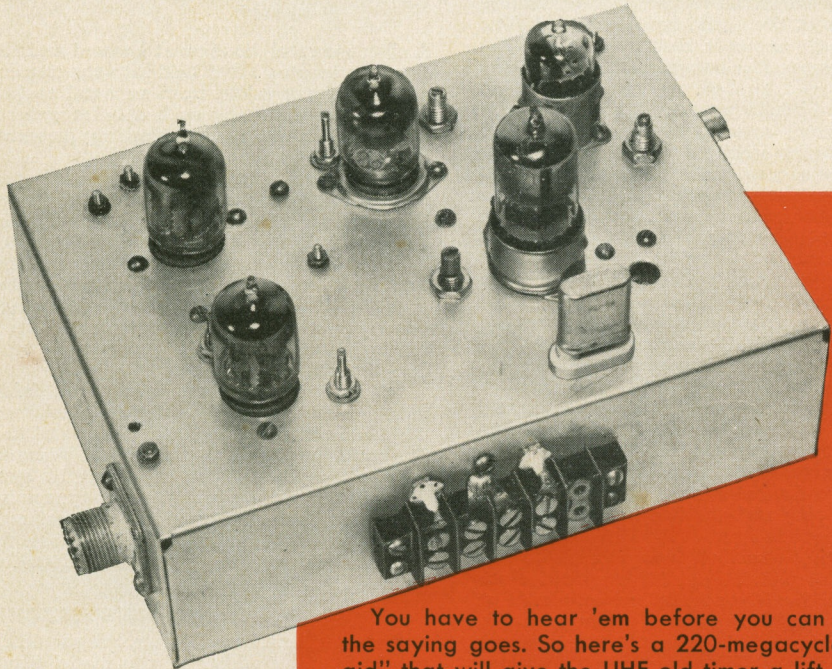

You have to hear 'em before you can work 'em, the saying goes. So here's a 220-megacycle "hearing aid" that will give the UHF old-timer a lift—and give the UHF tyro a good start. It's a 220-225-megacycle crystal-controlled converter that feeds a 10-15-megacycle signal into a communications receiver. Take a look, fellows.

*—Lighthouse Larry*

## CONTENTS

220-Megacycle Converter . . . . .	page 2
Restoring Crackle Finish . . . . .	page 6
Sweeping the Spectrum . . . . .	page 7
UHF DXpert . . . . .	page 8

# 220-MEGACYCLE CONVERTER

## CIRCUIT DESCRIPTION

This 220-megacycle converter uses 6AJ4 and 6AM4 type tubes developed by General Electric especially for high-frequency service. As shown on the circuit diagram, two stages of radio frequency amplification are used. These are 6AJ4's in grounded grid service rather than in cascode circuits because of the relative ease in getting the circuits into operation. Performance does not seem to be impaired, because the noise figure was found to be between 5 and 6 db. In addition, the circuit is not critical to adjust.

A 12AT7 is used as a fixed oscillator, the first stage operating at 70 megacycles with an overtone crystal in a Butler-type circuit. The second half of the 12AT7 triples to 210 megacycles, and this frequency is injected into the 6AM4 mixer by means of a 1 micro-microfarad coupling capacitor. The resultant intermediate frequency varies from 10 to 15 megacycles, depending upon the frequency of the signal being received. The 220- to 225-megacycle amateur band thus is covered by tuning the station receiver between 10 and 15 megacycles.

Two Butler-type circuits were built, both using a 70-megacycle overtone crystal, and each oscillated satisfactorily. If a lower oscillator crystal frequency is to be used, it will be necessary to rearrange the circuit and add another multiplying stage. In this event, a 7.77-megacycle crystal could be used in a stage which picks off its third overtone of approximately 23 megacycles—and then multiplication continued to 210 megacycles as in the circuit described here. The oscillator circuits were set up initially with a grid-dip oscillator and required some later adjustment in tuning and coupling to optimize performance. The variable capacitors specified allow plenty of tolerance for circuit variations.

The 6AM4 mixer stage is a grounded cathode circuit. This tube has five grid pins, and no trouble was encountered in using two of these pins. The three unused grid connections were removed from the socket to minimize stray capacitance. A single-stage IF amplifier uses slug-tuned coils and a 6AK5.

The converter requires from 125 to 150 volts of B plus rated at 50 to 60 milliamperes and a 6.3-volt filament source that will handle 1.2 amperes. Both the filament and high-voltage leads are by-passed at the terminal block by feed-through capacitors ( $C_{25}$  and  $C_{26}$ ) to prevent possible interference from a strong shortwave station at the IF frequency which might enter the converter through the power connections. If such a station is nearby, it may be necessary to cover the 6AM4 and 6AK5 and use a bottom plate on the chassis. Such precautions prevent frayed nerves when trying to copy 220 DX.

## NOISE PERFORMANCE

As always at these frequencies, noise is an important factor and considerable success was experienced in reducing this figure.

In the VHF and UHF range the ultimate sensitivity of a receiver or converter is limited by its noise figure. It is important to reduce noise figure as low as possible. If the noise figure is reduced from 15 db (a not uncommon figure) to 5 db, it has the same effect as raising by 10 times the power output of the station sending to the receiver. The 6AJ4 and 6AM4 tubes were designed to provide top performance at the UHF television range, and they perform beautifully at 220 megacycles.

A noise generator should be used to optimize performance. Such circuits have been described numerous times in amateur publications, and the circuit of the one used to set up this converter is shown in Figure 1.

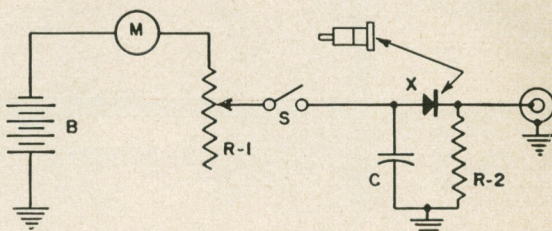

Fig. 1—Home-built noise generator uses a 0 to 2 ma meter

- C—.001 mfd ceramic disc or tubular
- R<sub>1</sub>—10,000-ohm potentiometer
- R<sub>2</sub>—56 ohms, 1/2 watt
- X—silicon diode (1N22 or 1N23)
- M—0-1 or 0-2 ma d-c meter
- B—3 volts

A silicon crystal diode must be used and the one shown here is a surplus 1N23 held into the circuit with a fuse clip and a pin taken from an octal socket. The time spent in constructing such a noise generator will be more than made up in optimizing performance of the converter.

The general procedure used for this converter was to first set it up for maximum gain (as measured at the detector of the station receiver) with a signal generator that will put out a 220-megacycle signal. After this was done the noise figure of the converter was measured on a laboratory-type noise generator and found to be 9 db. Then the home-built noise generator was connected to the receiver, and adjustments made as described below until optimum noise performance was obtained.

When finally checked against a laboratory-type noise generator, the noise figure was between 5 and 6 db—fairly respectable performance at 220 megacycles. It should be noted that optimum noise figure is not necessarily obtained at the point of optimum gain. Thus, in the absence of laboratory-type noise generators which can actually measure the noise figure, it is important to adjust for minimum noise figure on the home-built noise generator rather than for maximum gain.

## PRELIMINARY CONSTRUCTION

Construction is not difficult, but should closely follow the layout and wiring of the model illustrated. The converter contains a total of 55 parts to be wired in—that is, capacitors, resistors and coils. This averages only about nine parts for each of the six stages—and only five of the connections are particularly critical. The accompanying illustrations have been carefully made with a view to assisting the reader in following the construction as closely as possible.

A 5x7x2-inch aluminum chassis should be laid out according to Figure 4—although slight variations are permissible to accommodate the actual parts the builder has gathered. It is wise to have on hand all the necessary parts—including the coils—before starting construction. Care should be taken to drill tube socket-mounting screw holes so that sockets will be properly oriented.

After the chassis is drilled and punched, the following parts can be mounted: RF connectors, terminal block and its feed-through capacitors, crystal socket, IF coil forms, the 4-30 micro-microfarad ceramic trimmer, the tubular ceramic trimmers, the variable air capacitor, and the four tie-points which support

the RF chokes and the 100-ohm decoupling resistors. Miniature ceramic stand-off insulators made by Cambridge Thermionic Corporation are used for this latter purpose in the model shown, but ordinary 1- or 2-point terminal strips will serve.

Before mounting the tube sockets, some of the unused lugs of the tube sockets of the first RF stage and the mixer stage are removed to reduce stray capacity. In the first 6AJ4 stage, tube socket lugs 1 and 3 should be removed; and in the 6AM4 stage tube socket lugs 3 and 6 should be removed. This operation is easily accomplished by flattening the locking dents in the lugs with a pair of long nose pliers and then pushing them out through the top of the socket.

When mounting the tubular ceramic trimmers ( $C_1$ ,  $C_3$ ,  $C_7$  and  $C_{10}$ ), note they should be oriented so their lugs can be soldered directly to the tube socket lugs.

Small strips of copper about 3/16-inch wide are fashioned for soldering between pins 4 and 9 of the first 6AJ4 socket, and between pins 1, 3-4, 6 and 9 of the second 6AJ4 socket. As shown in Figure 5, these shields are connected to the base sleeve of the socket.

#### COIL WINDING DATA

While coil specifications in the components list accompanying the schematic diagram are complete, it might be well to mention that  $L_6$  and  $L_7$  can be wound on any type form as long as the finished product, in the circuit, tunes the IF frequencies of 10 to 15 megacycles.

After winding RFC<sub>1-4</sub> and  $L_8$  on the threads of a 1/4-20 bolt, it is possible to carefully unscrew the bolt from the coils without disturbing the spacing. It is wise to leave the leads longer than necessary until ready to wire the coils into the circuit.

#### WIRING DETAILS

The filament leads, RF chokes and high-voltage leads can be wired first. Wiring of the remaining components should follow—with the exception of  $C_5$ ,  $C_9$ , and  $C_{22}$  and the input lead from the RF connector to the cathode of the first 6AJ4. Care should be taken to keep RF leads as short as possible.

In wiring, note the placement of  $C_{11}$  and  $C_{12}$  on each side of pin 2 of the 6AM4 socket. Two capacitors are used here to reduce lead inductance. In the model shown (Fig. 5) two 200-ohm resistors are used for  $R_5$

—one connected to pin 2, the other to pin 7 (both cathode pins) of the 6AK5. One 100-ohm resistor connected to either pin will serve, however.

Connection of  $C_5$ ,  $C_9$  and  $C_{22}$  and the RF input lead to their associated coils is somewhat critical for optimum noise figure and the adjustment procedure is described below.

#### ADJUSTMENT PROCEDURE

The home-built crystal diode noise generator does not give noise figure in actual db. It is a comparison device only, and merely tells the experimenter whether the adjustments he makes on his converter are in the right direction. With the particular crystal and components used in the home-built noise generator shown, it was found that 1 milliamperes of reverse crystal current—indicated on the noise generator meter—is equal to approximately 10 db of noise when compared with a laboratory noise generator.

Unless the builder has access to such a laboratory instrument, he will not be able to measure precisely the noise figure of his converter. However, if the construction and adjustment instructions are closely followed, he can be sure that when he has attained optimum performance as indicated with his own home-built noise generator, the noise figure of his converter will be comparable to the converter described herein.

The adjustment procedure for obtaining the best noise figure involves moving the connections of the RF input lead,  $C_5$ ,  $C_9$  and  $C_{22}$ . Of course, before these adjustments can be made, these components must be soldered in to check voltages and set the converter up for maximum gain. It is suggested that as a starting point, the RF input lead from the antenna connector be soldered directly to the cathode pin of the socket of the first 6AJ4. The connection of  $C_5$  to  $L_2$  can be made at the center of  $L_2$ . Then  $C_9$  can be soldered from a point about a half-turn down from the plate end of  $L_2$  directly to pin 9 of the 6AM4.  $C_{22}$  can be connected between grid pin 4 of the mixer tube and tapped down about a half turn from the plate end of  $L_{10}$ .

With these connections made, the first step is to use a signal generator as mentioned above—or a fellow ham's 220 mc transmitter—and make the usual adjustments of the tuned circuits to get maximum gain. Once this is accomplished, the objective of subsequent ad-

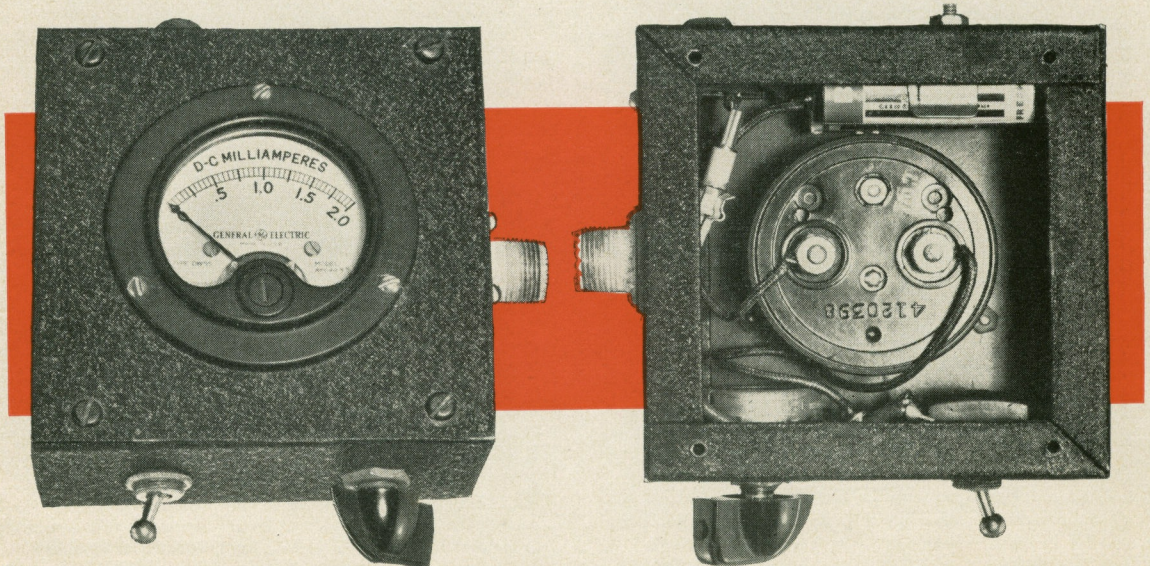

Fig. 2—Two penlite cells supply power for the noise generator

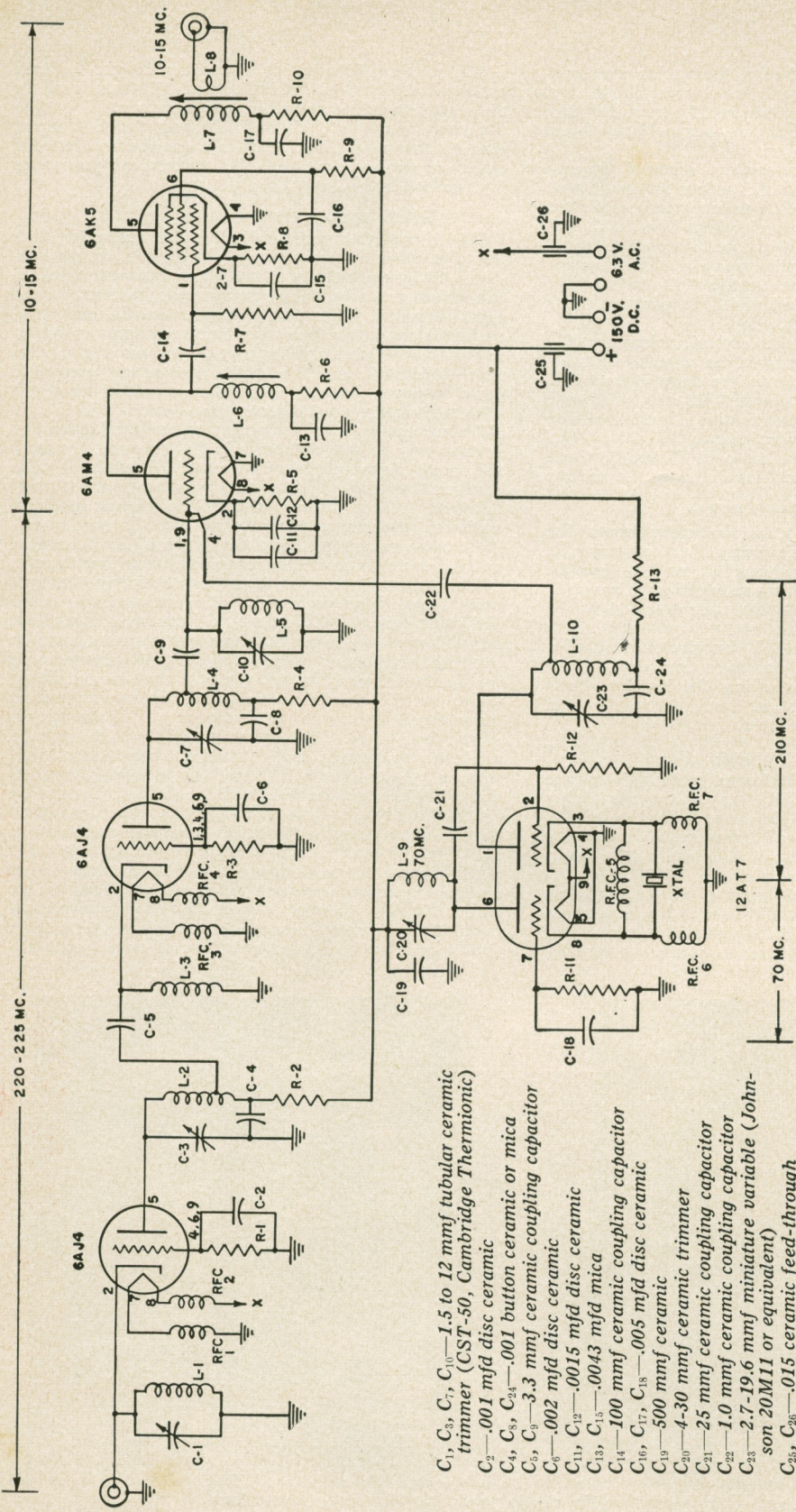

Fig. 3—Circuit diagram of 220-megacycle converter

- C<sub>1</sub>, C<sub>3</sub>, C<sub>7</sub>, C<sub>10</sub>—1.5 to 12 mmf tubular ceramic trimmer (CST-50, Cambridge Thermionic)
- C<sub>2</sub>—0.01 mfd disc ceramic
- C<sub>4</sub>, C<sub>5</sub>, C<sub>24</sub>—0.001 button ceramic or mica
- C<sub>6</sub>, C<sub>9</sub>, C<sub>23</sub>—3.3 mmf ceramic coupling capacitor
- C<sub>8</sub>—0.002 mfd disc ceramic
- C<sub>11</sub>, C<sub>12</sub>—0.0015 mfd disc ceramic
- C<sub>13</sub>, C<sub>15</sub>—0.0043 mfd mica
- C<sub>14</sub>—100 mmf ceramic coupling capacitor
- C<sub>16</sub>, C<sub>17</sub>, C<sub>18</sub>—0.005 mfd disc ceramic
- C<sub>19</sub>—500 mmf ceramic
- C<sub>20</sub>—4-30 mmf ceramic trimmer
- C<sub>21</sub>—25 mmf ceramic coupling capacitor
- C<sub>22</sub>—1.0 mmf ceramic coupling capacitor
- C<sub>23</sub>—2.7-19.6 mmf miniature variable (Johnson 20M11 or equivalent)
- C<sub>25</sub>, C<sub>26</sub>—0.015 ceramic feed-through
- R<sub>1</sub>, R<sub>3</sub>—5 megohm
- R<sub>2</sub>, R<sub>4</sub>, R<sub>5</sub>, R<sub>13</sub>—100 ohms
- R<sub>6</sub>, R<sub>10</sub>—1000 ohms
- R<sub>7</sub>—7500 ohms
- R<sub>8</sub>—3000 ohms
- R<sub>9</sub>—10,000 ohms
- R<sub>11</sub>—20,000 ohms
- R<sub>12</sub>—20,000 ohms
- L<sub>1</sub>, L<sub>2</sub>, L<sub>4</sub>, L<sub>10</sub>—3t. No. 14 wound on 1/2-inch d. form, 3/8-inch long
- L<sub>3</sub>—5t. No. 14 wound on 1/4-inch d. form, 1/2-inch long
- L<sub>5</sub>—3t. No. 14 wound on 3/16-inch form, 3/8-inch long
- L<sub>6</sub>—35t. No. 30 en. close-wound on 1/2-inch slug-tuned ceramic form (CTC-LS7)
- L<sub>7</sub>—40-45t. No. 30 en. close-wound on same type form as L<sub>6</sub>
- L<sub>8</sub>—4t. link insulated wire on cold end of L<sub>7</sub>
- L<sub>9</sub>—5t. No. 14 wound on 1/2-inch form, 1/2-inch long
- RFC<sub>1,4</sub>—12t. No. 24 en. wound in threads of 1/4-inch long
- RFC<sub>5</sub>—5t. No. 24 en. close-wound on a 7/8-inch length of 1/4-inch d. polystyrene rod
- RFC<sub>6,7</sub>—35t. No. 30 en. close-wound on a 3/4-inch length of 1/4-inch d. polystyrene rod
- XTAL—70-megacycle overtone-type crystal (Midland or equivalent).

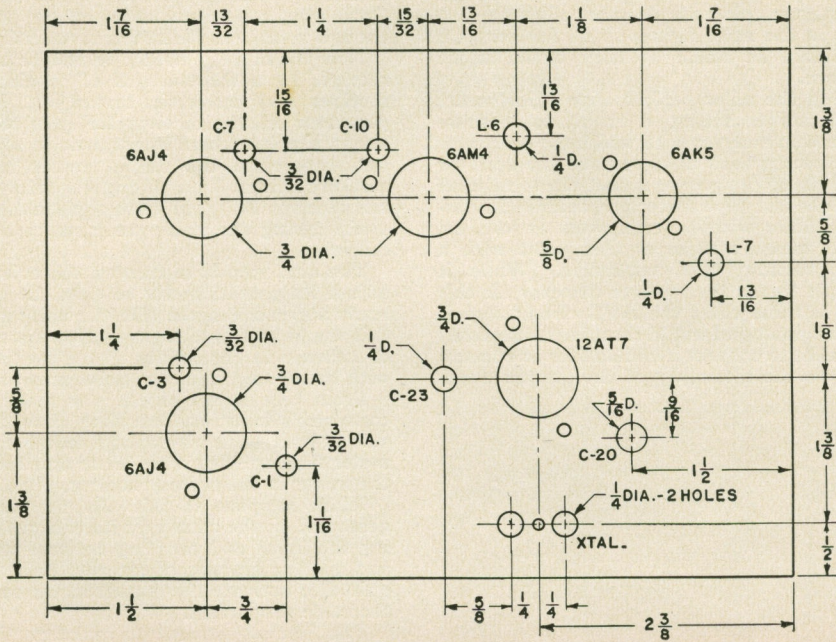

Fig. 4—Chassis layout

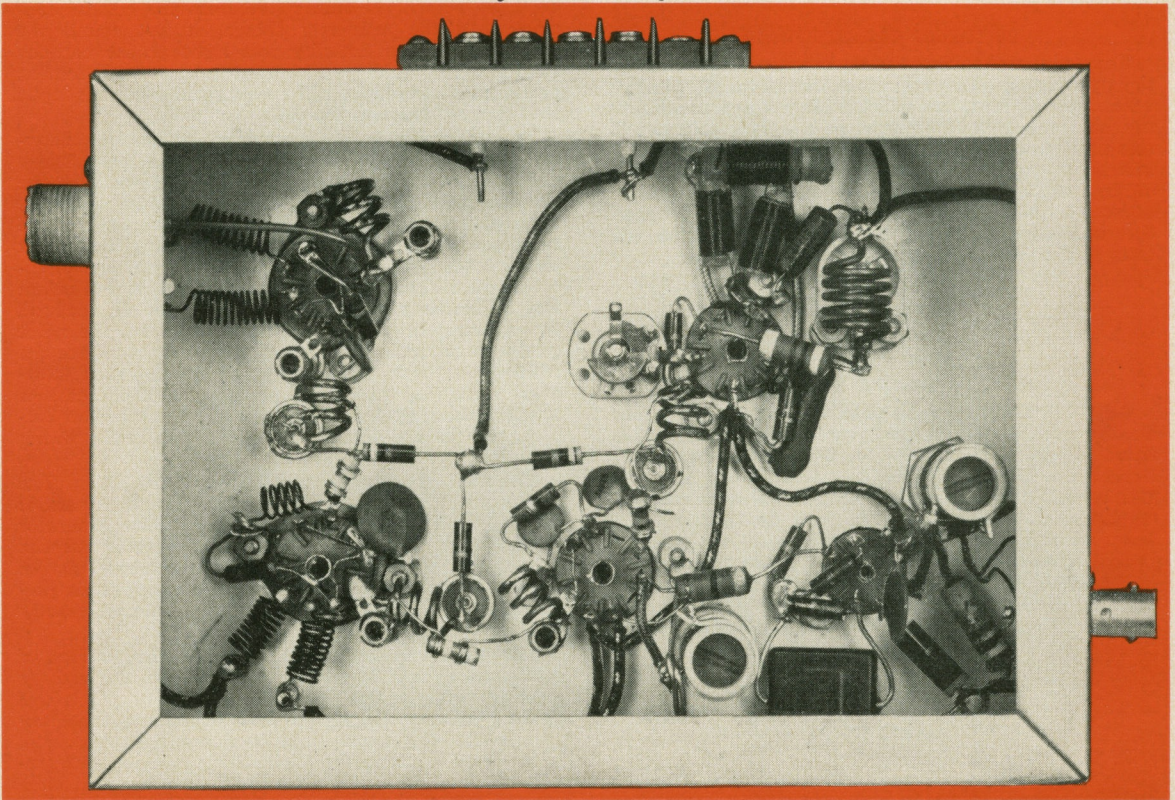

Fig. 5—Bottom view of 220-megacycle converter. RF input at top left, second RF amplifier at bottom left corner; mixer tube and slug-tuned plate coil ( $L_6$ ) at bottom center; and IF amplifier and final tank coil ( $L_{7-3}$ ) at bottom right. At top right is crystal socket,

the 12AT7,  $C_{20}$ ,  $C_{23}$  and other components associated with the oscillator circuit. The 6AM4 plate resistor and plate by-pass are hidden under the lower lip of the chassis. In this view most of the parts can be identified by checking their connections to tube pins.

justments is to improve the noise figure. As mentioned earlier, the converter gain may decrease slightly—but the real test is in the noise figure; so no further gain adjustments should be made as they would upset noise performance.

Before starting the noise performance adjustments it will be necessary to set up a circuit to measure output in the station receiver with which the converter is to be used. One method is to remove the receiver detector tube and use the proper socket pin to take off the signal from the last IF transformer, rectify the current therefrom either with a germanium or vacuum tube diode and measure noise at this point with a millimeter or vacuum tube voltmeter. (While it would be possible to use the receiver detector for this rectifying job, in most cases the AVC circuit also is hooked on at this point and would complicate matters.)

It is also possible to connect a milliammeter or vacuum tube voltmeter to the secondary of the output trans-

former, providing there is a 500-ohm output tap. Ordinarily, an 8-ohm audio output will not provide enough voltage to measure conveniently.

Now the noise generator should be connected to the receiver by a short length of coaxial cable and the receiver and converter turned on. With the noise generator off, the receiver RF gain control should be set at a point where internal noise registers about .5 milliamperes on the output meter attached to the station receiver. After this reference level is established, the receiver RF gain control should not be touched again during the noise performance adjustment procedure.

The next step is to turn on the noise generator and adjust its potentiometer so that the generator meter reads about mid-scale. (On the noise generator shown this would be 1 milliamperes.) Now note the percentage of increase in the output meter reading as compared with its reading when the noise generator is off.

From here on the object is to make changes in the converter's input and coupling circuits which will result in this same percentage increase in the output meter reading—but with lower and lower readings on the meter in the noise generator.

What happens is this: As the amount of noise generated in the converter itself is reduced by adjusting the input and coupling between stages, a smaller and smaller amount of external noise injection is required to activate the output meter on the receiver in the same proportion.

The first adjustment to make on the converter to improve noise performance is to find the best point on  $L_1$  to attach the input lead from the coaxial connector. In the converter shown, it was found the best tap position actually was right at the cathode tube pin. It is quite possible that in some other models optimum performance will be obtained with this input lead tapped down on the coil.

The following procedure should be used to determine the correct point to tap the input lead: Every time the input lead is moved so that it changes the percentage of increase on the output meter when the noise generator is turned on, the potentiometer on the noise generator should be adjusted to bring the output meter reading to a point where the percentage of increase on the output meter is the same as it was before the adjustment procedure was started. If the coil tap adjustment was in the right direction, the noise generator potentiometer adjustment should reduce the reading on the meter in the noise generator. If, however, obtaining the same percentage of increase is accomplished by increasing the noise generator current, the coil tap adjustment was a step in the wrong direction.

The next adjustment to make is the tap on  $L_2$ . The lead from  $C_5$  should be soldered on the coil at various points—each time readjusting the noise generator potentiometer to see if the noise generator current goes down when obtaining the same increase on the output meter. In the converter shown, optimum performance was obtained with  $C_5$  tapped almost exactly at the center of  $L_2$ .

The third important adjustment is the amount of oscillator voltage injection. This can be changed by trying various values of coupling capacity ( $C_{22}$ ), and also by moving the tap on  $L_{10}$ . In making these adjustments, the same procedure outlined above is followed. The converter shown hit optimum performance with a 1 micro-microfarad coupling capacitor tapped about a half turn down from the plate end of  $L_{10}$ .

Adjustment of  $C_9$  did not seem to make much difference in noise performance in the converter shown. However, it might be worth while trying tapping the leads of this capacitor at different points on  $L_4$  and  $L_5$ .

## Tricks &

## TOPICS

### RESTORING CRACKLE FINISH

Tops of metal cabinets often become dingy and unsightly with age. These surfaces are not readily cleaned with water or furniture polishes. A few experiments in my ham shack have resulted in a simple solution to this problem. Apply with a cotton cloth a few drops of mineral oil to the dull crackle surface. Wipe off excess oil by hard rubbing with a clean cloth. Automotive oil such as No. 20 or 30 is excellent for the purpose. The original sparkle and uniformity of the finish will thus be obtained. Try it and you'll be amazed.

—Robert E. Burnett, W2YIV

### HOW TO GET G-E HAM NEWS

G-E HAM NEWS may be obtained free from G-E tube distributors—or, for \$1 per year G.E. will mail HAM NEWS to your home. Write to: G-E HAM NEWS, Tube Department, General Electric Co., Schenectady 5, N. Y. This subscription plan is available to amateurs only in the United States, Alaska, Hawaii and the Panama Canal Zone. Amateurs in Canada should address requests to Canadian General Electric Co., Ltd., Electronic Tube Marketing Section, 830 Lansdowne Ave., Toronto, Ontario, Canada. In all other countries G-E HAM NEWS may be obtained through International General Electric distributors.

### PARASITICS

In the schematic diagram for the VTVM Adapter described in the July-August, 1954, issue of G-E HAM NEWS (Volume 9, No. 4) a chassis-ground connection in the negative (black) lead circuit was not indicated. While this omission will not affect the d-c operation of the instrument, such a ground is necessary to provide a return path for RF when using the RF probe with the chassis-grounded connector indicated.

# SWEEPING *the* SPECTRUM

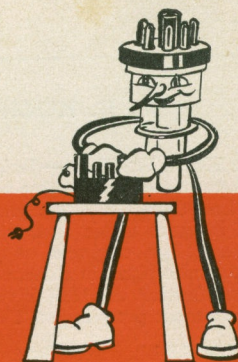
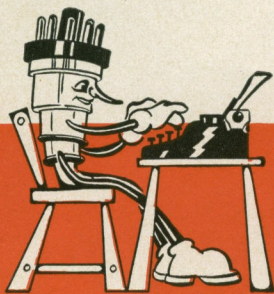

Several people have remarked, after reading about the Edison Radio Amateur Award winner and the runners-up who received special citations, that they know someone who also rendered an outstanding public service. In each case, however, no one took the trouble to nominate the amateur in question. Thus his work went unnoticed by the judges of our Award. As in most such awards, one of the biggest jobs is hunting for Award candidates. This is especially true with amateur radio awards because for the most part amateurs are modest individuals. So if you know of an amateur you feel worthy of the Edison Radio Amateur Award, be sure to nominate him. The rules of the Award are given in our advertisements in the September and October issues of both CQ and QST magazines.

\*\*\*

W $\phi$ NPA apparently found there are no secrets in a ham wedding—what with mobiles all over the place reporting your every movement. "Ham Hum," published by Ak-Sar-Ben Radio Club (W8EQU), reports mobiles were stationed at the church and at the happy couple's "hidden" get-away car.

\*\*\*

A note in "Sparks," published by the Brandon (Manitoba) Amateur Radio Club, informs us that VE4PA visited VE4WW and VE4SB and "spent a couple of fruitless hours watching the snowflakes on Gordon's 21-inch video screen." Also, "Gordon (VE-4WW) is quite happy over three and a half minutes of transmission from Memphis a week ago last something-or-other. Anyway it's a nice piece of furniture." Some of us in the "more advanced" TV locations are wondering if the lads up that way know really how well off they are!

\*\*\*

"Show me a man who has a hobby and I'll show you a conscientious man whose effort and success is above average. Of all the hobbies, it is safe to say ham radio is the most complete both politically and technically. No other hobby can serve the public as adequately as can ham radio. Probably no other hobby has as many jealous commercial interests eyeing our assets. No other hobby can or has helped the advance of electronics as ham radio has done."

Thus writes W9YME in "Marc Sparks," published by the Michiana Amateur Radio Club (W9AB). He adds that none of these achievements can or could be accomplished without the co-operative efforts of individual hams organized into clubs. Individually, he

points out, we are but persons with hobbies; collectively, we constitute a powerful force that can help not only ourselves but our community, our nation and the world. And I might point out all that is in addition to the fun and fine friendships club activities can bring.

\*\*\*

Our first Bound Volume was so popular, we are getting a lot of requests for a second Bound Volume. The first volume contained all the issues of G-E HAM NEWS published from 1946—when G-E HAM NEWS began—through 1950. We plan to make up another bound volume at the end of our second five-year period of publication. Thus our second Bound Volume will contain all issues published in the years 1951 through 1955.

We're sorry it is so long between Bound Volumes, but publishing bi-monthly as we do, it takes that long to accumulate sufficient issues to make binding worthwhile. If by any chance any of you wish to make reservation at this early date for the second Bound Volume of G-E HAM NEWS, we'll be glad to keep your name and address on file until the book is ready. *But please do not send any money now!* We sell the Bound Volumes at the cost of binding and handling (the first one cost \$2 per copy) and we cannot tell at this time just what binding will cost a year and a half from now.

\*\*\*

The editor was looking over ARRL's bibliography of TVI literature the other day and reminded us to remind you that we still have some back copies of the issue of G-E HAM NEWS which described our "TVR High-Pass Filter." This highly effective filter for a TV receiver input incorporates an interesting design feature and for a very few cents can be put together in a matter of minutes. It appears in the March-April, 1951, issue of G-E HAM NEWS (Volume 6, No. 2). I'll be glad to send you a copy, if you want one. Incidentally, one of the fellows who used one of these little filters reported it was highly effective as a fuse when lightning struck his TV line. He said the filter just seemed to evaporate. He couldn't find more than a few droplets of copper left. But the TV set was still there. We don't recommend the filter as a substitute for normal lightning arresting precautions, however.

—Lighthouse Larry

## UHF DXpert

### A. R. KOCH, W2RMA

Art Koch, W2RMA—designer of the 220-megacycle converter described in this issue of G-E HAM NEWS—makes G-E UHF klystrons tick during the day. Then he goes home and makes UHF ham rigs tick. He's a design engineer at the industrial and transmitting tube plant in Schenectady and has supervised the installation of UHF klystrons in a number of the nation's most progressive TV stations.

G.E.'s 12-kilowatt klystrons come in six types—each covering a segment of the 470 to 890-megacycle UHF TV band. They are tunable within their ranges and are triple-resonator type tubes. Klystrons stand about five feet high, draw 35 amperes of heater current at 5.5 volts, and require 17,000 volts d-c at 3 amperes. Driving power averages 25 watts—and most stations use a 4X150 as driver. Two klystrons are used in a UHF-TV station—one to amplify the visual signal, the other to amplify the sound—and the two are mixed in a "Filtrexer" before being fed into the antenna.

Art, shown here setting up some gear to test a klystron, is the designer of one of the UHF cavities illustrated in the ARRL Handbook, and the Super 430 (G-E HAM NEWS, Volume 8, No. 4).

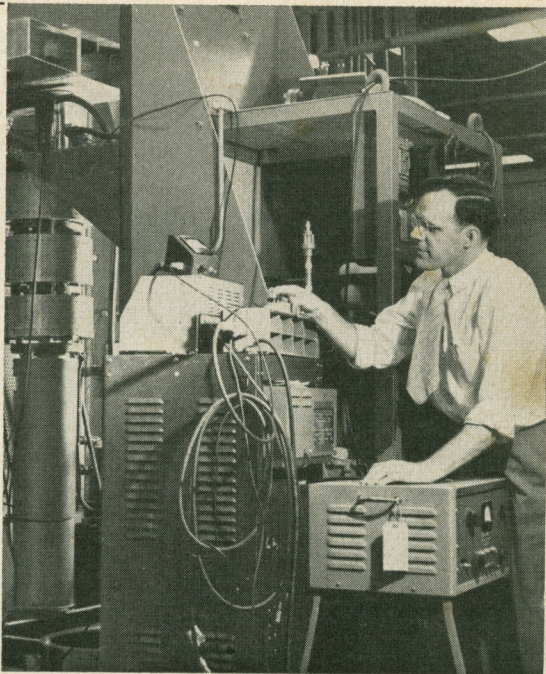

# G-E HAM NEWS

Available FREE from

G-E Electronic Tube Distributors

Printed in U.S.A.

VOL. 9 - NO. 5

published bi-monthly by

TUBE DEPARTMENT

GENERAL  ELECTRIC

Schenectady 5, N. Y.

In Canada  
Canadian General Electric Co., Ltd.  
Toronto, Ontario

S. E. McCALLUM, W2ZBY—EDITOR

SEPTEMBER - OCTOBER, 1954