



Electronic
TUBE

2/21/57
6E
Allan C. Mueller
Ham News

Copyright 1952, by General Electric Company



JULY-AUGUST, 1952

VOL. 7—NO. 4

MOBILE-MARINE RECEIVER

Specialized 80 Meter Superhet

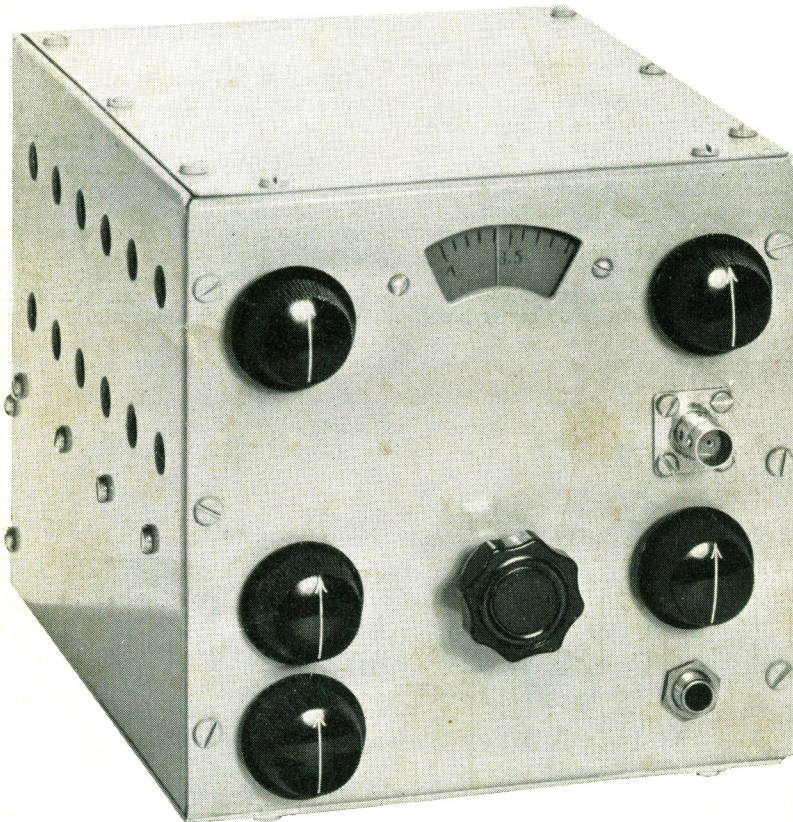

Fig. 1. Front view of the Mobile-Marine Receiver.

Contents

Mobile-Marine Receiver	pages 1-6, 8
Sweeping the Spectrum	page 7

MOBILE-MARINE RECEIVER

This receiver departs from the usual amateur gear in that it is designed to cover frequencies used by other services as well as the 3.5 - 4.0 megacycle band. This was prompted by the second hobby of the designer, namely boating, and, therefore, the desire to have on board a receiver which would not only cover the 80 meter band but allow monitoring the various Marine stations operating between 2.0 and 3.0 megacycles.

Since the keynote of this receiver is compactness with maximum performance and simplicity, no other bands were included. Other bands could have been included, however, as in all bandswitching receivers, the design would have been a compromise and maximum performance could not have been achieved. Also the addition of bandswitching would defeat the keynote of compactness and certainly add to make the circuit complex instead of simple.

The receiver about to be described is relatively simple and not difficult to build. The average amateur should have no trouble in constructing it and making it work properly.

DESIGN CONSIDERATIONS

During the design of this receiver it was realized that probably only a small percentage of amateurs are also boating enthusiasts. Therefore, provisions were made to allow the builder to select any portion of the frequency range between approximately 1.7 megacycles and 4.0 megacycles. In other words, for mobile operation the receiver can be adjusted to cover only the phone band, 3.8 megacycles to 4.0 megacycles, or as a home station receiver the range can be adjusted to cover the entire 80 meter band.

This is accomplished by merely adjusting the value of the series padding capacitors to be discussed later.

The total current drain is approximately 80 mls. No attempt was made to keep this down to a minimum as the receiver is used with the usual 300-volt, 100-milliamperer vibrator power supply. Past experience with this type of power supply has provided some unhappy memories of soaring B plus voltage when switching from a transmitter drawing the full 100 mls to a receiver drawing only 40 or 50 mls because of the poor regulation. Voltages produced at this low drain are in the order of 350 to 375 volts which means the tubes are not operating within their proper characteristic condition. Hence, maximum performance is not achieved.

Eight miniature tubes including a voltage regulator are employed in a full superheterodyne circuit. All of the popular superhet functions are incorporated: Antenna trimmer, R-F Gain control, AVC, BFO, Noise Limiter and Volume control. Provisions are also included for phone or loudspeaker operation.

No unusual or trick circuits have been included in this receiver for the simple reason that any piece of mobile equipment should be both reliable and easily repaired away from home. Trick circuits do not always lend themselves to this requirement.

CIRCUIT DETAILS

Refer to the circuit diagram, Fig. 2. A 6BJ6 serves as an r.f. amplifier. This type does not have the gain of a 6AK5, however, it does have the advantage of remote cutoff instead of sharp cutoff. Therefore, smoother AVC action is afforded. C₁ is the series padder condenser adjusted to the desired frequency range. C₂ is the main tuning condenser and C₃ is the antenna trimmer condenser.

Electrical Circuit

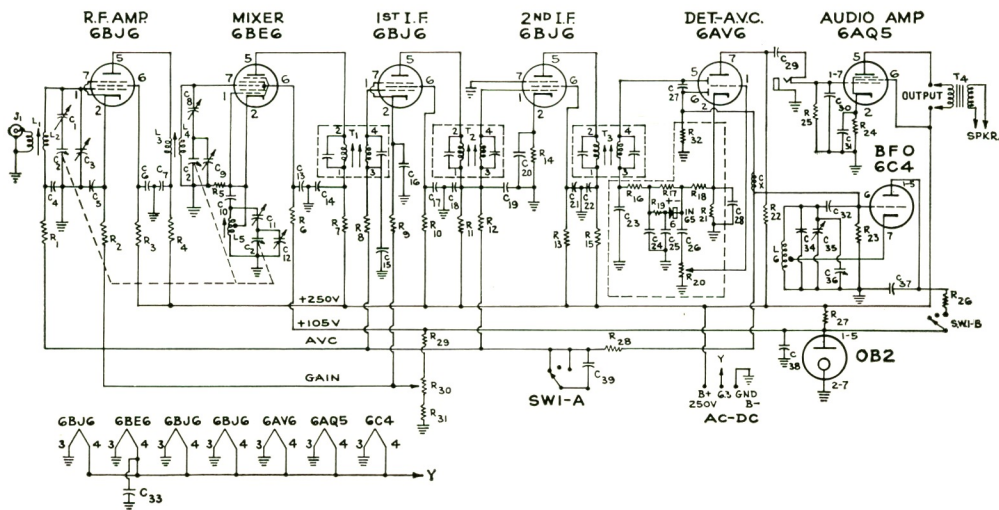

Fig. 2. Circuit diagram of the Mobile-Marine Receiver.

The 6BJ6 feeds a 6BE6 which serves as the local oscillator and mixer tube. Condenser C₈ is the series padder adjusted to the same frequency range as C₁. Condenser C₉ is the padder adjusted to provide tracking as well as C₁₂.

The tuning system, C₁, C₂, C₃, C₉, C₁₁, and C₁₂, is exceptionally flexible to allow selection of the tuning range and to make tracking easy. Both slug tuning and series padding is incorporated to allow tracking adjustment to be made at both the high and low ends of the range.

The mixer feeds a 6BJ6 as the first i.f. amplifier which in turn feeds a second 6BJ6 as the second i.f. amplifier stage. The intermediate frequency of the i.f. stages is 455 kilocycles. One stage of i.f. would have given sufficient gain but the selectivity would have been poor. Therefore, two i.f. stages were incorporated operating at reduced gain to provide adequate selectivity. To further increase the selectivity, J. W. Miller miniature permeability tuned i.f. transformers, types 12C1 for T₁ and T₂ and type 12C2 for T₃, were used. These were not connected up in the usual manner but rather with the primary and secondary reversed; that is, with terminal number 2 going to the plate and terminal number 4 to the grid. Connected in this manner the bandwidth is narrower and the slopes of the selectivity curve steeper at the sacrifice of gain. It is recommended that these transformers be used to achieve the same degree of selectivity.

The second 6BJ6 feeds a 6AV6 which serves as the second detector, automatic volume control and first audio amplifier stage. This is conventional in all respects.

The noise limiter is a conventional self-adjusting shunt type circuit. A G-E type 1N65 germanium diode was selected because of its high front-to-back

resistance. No provisions were made to switch this circuit in and out as it was felt for mobile operation it would always be used because of the potential high noise level.

The beat frequency oscillator uses a type 6C4 in a conventional Hartley circuit. It is coupled to the output of the 6AV6 by Cx which is a 3 inch piece of wire twisted around the lead indicated in the circuit diagram. It is connected into the circuit by means of switch SW1B. For those who wish to use this receiver as mobile only, this part of the circuit can be omitted.

The output of the 6AV6 feeds a 6AQ5 as a class A1 audio amplifier. It is capable of approximately 4 watts output which is sufficient to drive a loud-speaker. The audio output transformer, T₄, is mounted on the speaker rather than the chassis in order to conserve space.

COMPONENT PARTS

The only critical component is the main tuning condenser, C₂. It should be of the type and make specified. The manufacturer's name and part number are shown in the Circuit Constants list whenever practical.

All resistors specified are of the ordinary plus or minus 10 percent or 20 percent tolerance. No precision types are required.

Use of the flat ceramic condensers specified is recommended as they permit short lead lengths in wiring and conserve space. Be sure you do not use flat ceramic condensers as substitutes for the mica condensers specified. All condensers are of the plus or minus 20 percent type with the exception of C₃₄ which is a zero temperature coefficient ceramic type. If the beat frequency oscillator is omitted, this condenser is not required.

CIRCUIT CONSTANTS

(All resistors and capacitors = 20% unless specified otherwise)

R ₁ , R ₈ , R ₁₂ , R ₂₅	0.22 meg., ½ watt	C ₂₅ , C ₂₉ , C ₃₉	0.1 mf, 600 volt paper (Aerovox Aerolite)
R ₂ , R ₉ , R ₁₄	82 ohm, ½ watt, ± 10%	C ₂₆	0.02 mf, 600 volt paper (Aerovox Aerolite)
R ₃ , R ₁₀ , R ₁₃ , R ₂₉	47,000 ohm, 1 watt	C ₂₇	50 mmf mica
R ₄ , R ₆ , R ₇ , R ₁₁		C ₂₈ , C ₃₁	10 mf, 50 volt electrolytic (Sprague TA510)
R ₁₅ , R ₂₁	2700 ohm, ½ watt ± 10%	C ₃₀	500 mmf mica
R ₅	22,000 ohm, ½ watt	C ₃₄	100 mmf, zero temperature coefficient ceramic
R ₁₆ , R ₁₇ , R ₂₃	47,000 ohm, ½ watt	C ₃₅	3-30 mmf ceramic padder
R ₁₈	0.15 meg., ½ watt	C ₃₆	1.7-8.7 mmf, sub-miniature variable condenser (E. F. Johnson 9M11)
R ₁₉ , R ₂₈ , R ₃₂	1.0 meg., ½ watt	Cx	see text
R ₂₀	1.0 meg. potentiometer (Centralab type B)	J ₁	coax jack, type BNC
R ₂₂	0.1 meg., ½ watt	J ₂	closed circuit phone jack
R ₂₄	470 ohm, 2 watt	T ₁ , T ₂	455 kc i.f. transformer, input type (J. W. Miller 12C1)
R ₂₅	22,000 ohm, 1 watt	T ₃	455 kc i.f. transformer, output type (J. W. Miller 12C2)
R ₂₇	5000 ohm, 10 watt	T ₄	output transformer, 5000 ohm to voice coil
R ₃₀	10,000 ohms potentiometer (Centralab type B)	L ₆	1 mh r.f. choke tapped (National R-300U, see text)
R ₃₁	470 ohm, 1 watt	SW ₁	2 pole, 3 position rotary switch (Mallory 3123J)
C ₁ , C ₈	130-450 mmf padder (ICA type 613) (See Text)	G	GE-1N65 Germanium Diode
C ₂	410-410-162 mmf, 3 gang variable condenser (Philmore 9048)	L ₁	15 T No. 32 enamel wire close wound on CTC type LS-4 coil form
C ₃	2.6-19.7 mmf, sub-miniature variable condenser (E. F. Johnson 20M11)	L ₂	65 T No. 32 enamel wire close wound, spaced 3/16 inch from L ₁
C ₄ , C ₅ , C ₆ , C ₇	0.01 ceramic (Centralab Disc Hi-Kaps, catalog number DD-103)	L ₃	30 T No. 32 enamel wire close wound on CTC type LS-4 coil form
C ₁₃ , C ₁₄ , C ₁₅ , C ₁₆		L ₄	65 T No. 32 enamel wire close wound, spaced 3/16 inch from L ₃
C ₁₇ , C ₁₈ , C ₁₉ , C ₂₀		L ₅	53 T No. 32 enamel wire close wound, tapped 12 turns from ground end, on CTC type LS-4 coil form
C ₂₁ , C ₂₂ , C ₃₃ , C ₃₇			
C ₃₈			
C ₉ , C ₁₂	part of C ₂		
C ₁₀	50 mmf ceramic, Hi-Kap, or mica		
C ₁₁	160-500 mmf padder (ICA type 614)		
C ₂₃ , C ₃₂	220 mmf mica		
C ₂₄	100 mmf mica		

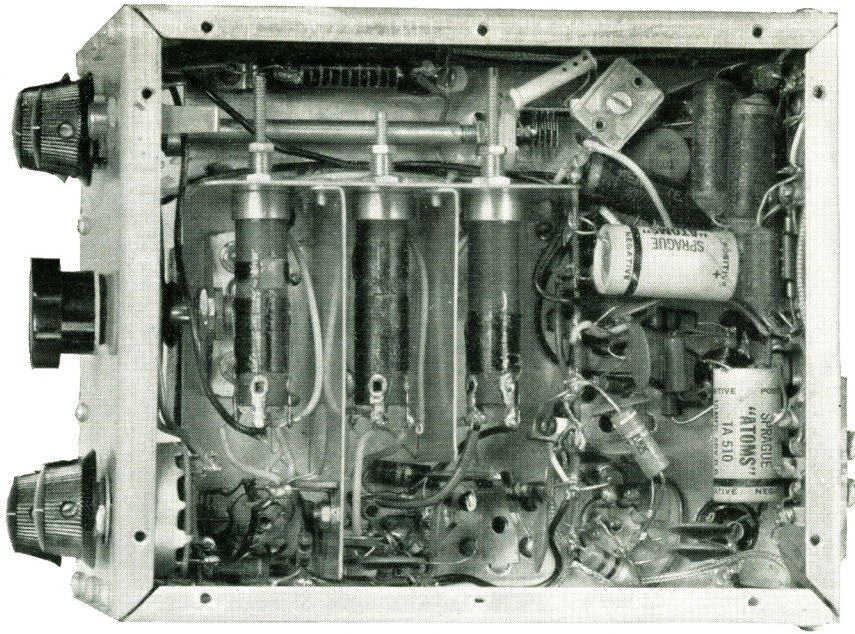

Fig. 3. Underchassis view of the Mobile-Marine Receiver.

As mentioned previously the i.f. transformers should be of the make specified. Other manufacturer's could possibly be used and connected in reverse with the same results but it will require some experimenting.

The coil forms specified are CTC type LS-4, $\frac{1}{2}$ inch diameter with a powdered iron slug. Ceramic coil forms can be substituted if desired, however, they should have a powdered iron slug and not a brass slug, if experimenting for the correct number of turns is to be avoided.

The output transformer, T₄, may be of any type which will match a 5000 ohm load to a speaker voice coil. This item is not critical in any respect.

CONSTRUCTION DETAILS

It is recommended that the mechanical layout shown in the photographs and sketches be followed faithfully. Considerable thought was given to the mechanical design and layout since compactness is the keynote in any mobile equipment. Note that the various stages are placed in an orderly straight-line manner to allow the wiring to be short and direct as possible. The cabinet was fabricated from 1/16 inch thick aluminum sheet and arranged so that it may be completely disassembled. All components are mounted on the chassis and panel. When the sides, top and bottom are removed, the components and wiring are all easily accessible without probing into corners or small compartments.

The only shield partitions and brackets required are those around the coils and the padding condenser bracket. An inspection of Fig. 3 and Fig. 4 will disclose the details. Dimensions are not given for these parts, however, no difficulty should be encountered as the actual sizes are not critical.

The first step in constructing the receiver is to make the complete cabinet. It is recommended that the parts be made in the following order:

- 1 - chassis
- 2 - sides
- 3 - top
- 4 - bottom plate
- 5 - shield partitions and brackets

All parts are made of 1/16 inch thick soft aluminum except the top, shield partitions, and brackets which are made of 1/32 inch thick aluminum. By using this material it is practical to make the bends in a vise by using two pieces of wood between the jaws and both sides of the work and just long enough to equal the length of the bend. The easiest procedure is to make the bends by using a third piece of wood held in both hands in back of the aluminum and carefully pulling the work forward and down at the same time. This will result in a smooth even bend. Of course, if a sheet metal brake is available the job will be easier. This tool is by no means essential for working small pieces of soft aluminum.

In constructing the chassis, make the lip bends first by clamping the lip portion in the vise and using the larger area for leverage. The rear of the chassis should be bent down last. Figure 5 gives the dimensions of the chassis excluding the bend and the lips. Figure 6 gives the dimensions of the rear bend and the lips.

Using the chassis as a guide for dimensions, the sides and panel can then be made. It is advisable to make these partly from actual measurements from the preceding parts in the order stated above rather than from the drawings as it is difficult to hold exact dimensions when making the bends. A good workman-like job will result if the parts of the cabinet are hand fitted to each other. The cabinet is held together by means of No. 6 x $\frac{1}{4}$ inch binding head, self tapping sheet metal screws.

In order to make the padding condenser bracket and shield partitions more rigid, small gussets are formed at the various bends. These gussets are made by placing the bent part over a piece of soft wood and then placing a 1/8 inch diameter steel rod at an angle of 45 degrees on the outside of the bend and striking it with a hammer. This will push the aluminum under the rod into the soft wood and result in a surprising increase in strength.

The particular three gang tuning condenser used came equipped with a dial cord drum and no shaft extension. Therefore, a dial cord drive was devised and a home made translucent dial was installed to

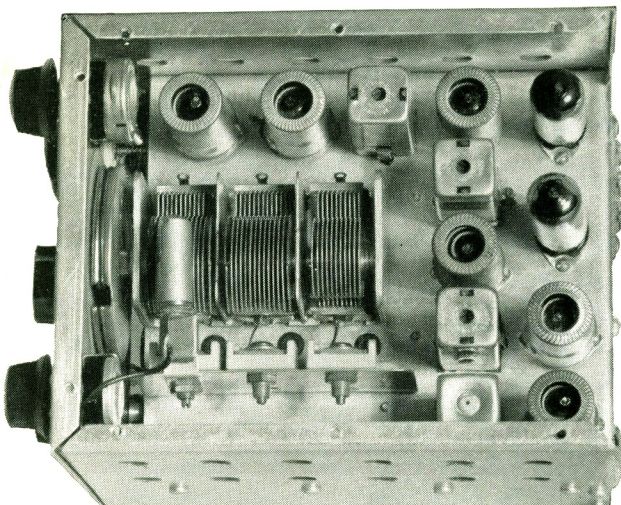

Fig. 4. Top view of the Mobile-Marine Receiver.

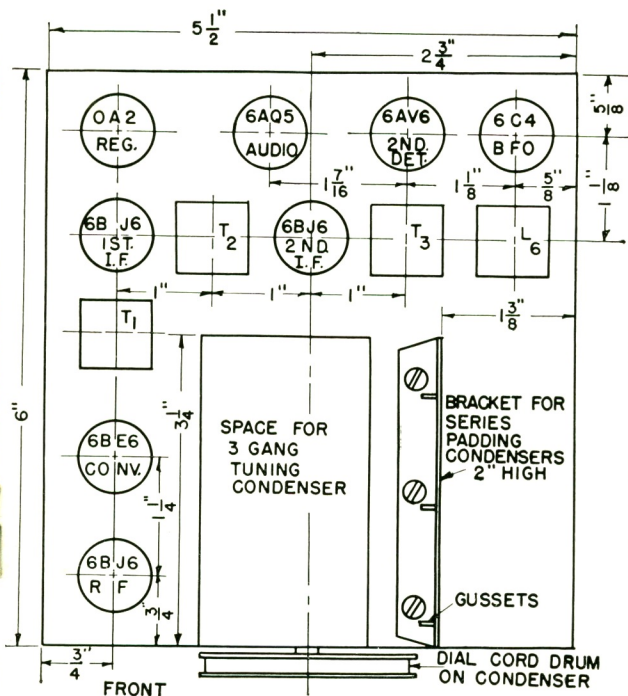

Fig. 5. Chassis layout of the Mobile-Marine Receiver.

allow for calibration marks. The dial drive was made by supporting a $\frac{1}{4}$ inch diameter shaft in a panel bushing held by a bracket to the underside of the chassis. This is lined up with the hole in the front panel. The vernier action is improved if the portion of the shaft around which the dial cord rides is turned down to about $\frac{1}{8}$ inch diameter. This may be easily done by turning the shaft in an electric drill and holding a rat-tail file against it. The dial plate itself is a piece of $\frac{1}{8}$ inch thick lucite with the surface frosted by rubbing with fine emery paper and water. The calibration marks can then be drawn on. It is recommended that this be done with pencil so the calibration can be changed easily if it is ever desired

to change the frequency range. The dial plate is bolted to the drum with small machine screws and bushings.

The beat frequency oscillator condenser, C_{36} , is fastened to the chassis with an angle bracket so that it lines up with the panel hole. A bushing is used in the panel to provide a smooth bearing surface. No commercial beat frequency oscillator transformer of small enough size was available so it was necessary to fabricate one. A National type R-300U, 1 mh r.f. choke was used as the coil. This choke has three pies. The cathode tap is made at the end of the first pie above the ground end of the coil. A $\frac{3}{4}$ inch square by 2 inches high shield can was obtained from an old TV i.f. transformer and the choke was mounted inside. It is necessary to melt the top metal end off of the choke coil with a soldering iron and unwind a few turns so that connections can be made at the bottom of the can. The threaded stud of the r.f. choke is bolted through the original bottom support of the i.f. transformer and the whole assembly is then mounted on the chassis in the normal manner. The beat frequency oscillator output is coupled to the second detector by means of capacitor C_x which is a three-inch piece of wire twisted around the lead indicated in the circuit diagram. The coupling is not critical but should be adjusted for good c-w reception.

The location of the r.f. coils can be determined by an inspection of Fig. 3. They should be centered midway between the chassis and the bottom plate.

The only subassembly required is the terminal board containing the second detector and noise limiter components. This is shown in Fig. 9. This unit can be made from a $\frac{1}{16}$ inch thick piece of bakelite or similar material. The terminals can either be No. 2 machine screws or some of the commercially available tiepoints. This subassembly should be wired up outside the receiver. Fairly long leads should be left so that connection to the points indicated can be made later.

The power and output transformer terminals are located on the rear of the chassis. They are visible in Fig. 3. The output transformer itself is not part of the receiver but rather a part of the loudspeaker.

WIRING DETAILS

In wiring the receiver it was found advisable to make up a temporary front panel out of scrap aluminum and fasten it to the chassis with brackets. This allows the controls to be wired in their proper position. After the wiring is complete and the receiver aligned the temporary panel can be discarded and the complete cabinet assembled.

The filament circuits should be wired first. Next, the stages should be wired starting with the audio output and beat frequency oscillator and working toward the front end of the receiver. The second detector sub assembly is mounted last against the back side of the chassis and wired in.

Tests were made after the receiver was complete to see whether lead dress would affect stability. No sensitive wires could be found so it is safe to assume that ordinary good wiring practice is all that is necessary to assure satisfactory results.

ALIGNMENT

After the wiring has been completed and rechecked it is necessary to align the various stages. The i.f. stages should be aligned first in the following manner. With proper voltages applied, the receiver should be allowed to warm up for a few minutes. A signal generator set at 455 kc should be connected through a small fixed condenser to pin number 5 of the second i.f. tube and the slug of T_3 adjusted for maximum output as indicated by headphones,

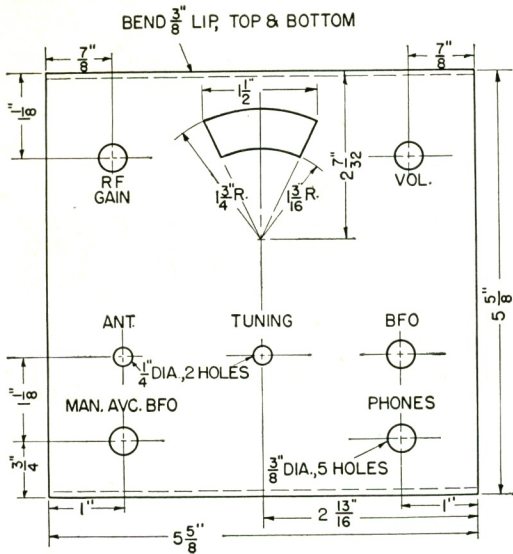

Fig. 7. Front panel layout of Mobile-Marine Receiver.

loudspeaker or an output meter. Next, the signal generator is connected to pin 5 of the first i.f. tube and the slug of T_2 adjusted for maximum output. The signal generator should then be connected to pin 5 of the mixer tube and the slug of T_1 adjusted for maximum output. This procedure should be repeated several times to be sure that each stage is peaked to the exact frequency. After this has been completed the r.f. section should be aligned on the high end of the tuning range. The main tuning condenser, C_2 , is set at minimum capacity and condensers C_9 and C_{12} set at maximum capacity and C_3 set at mid-position. With the signal generator set at 4.1 megacycles and connected to pin 1 of the

(Continued on page 8)

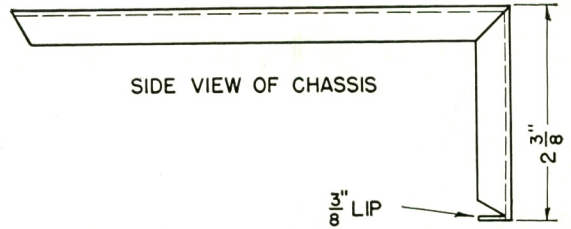
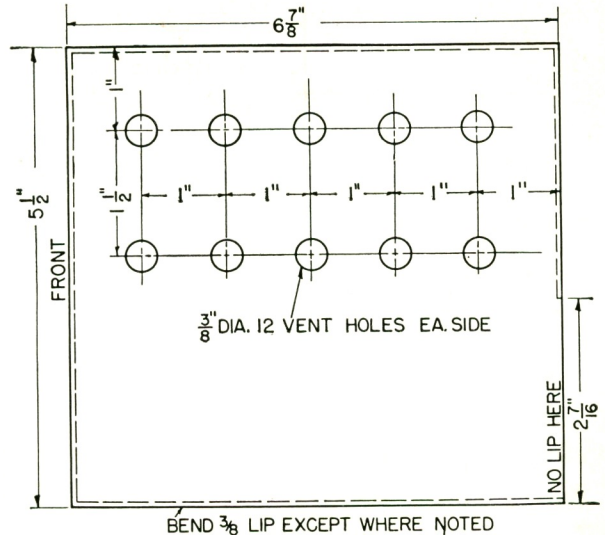

Fig. 6. Side View of chassis showing bends and lips.



BEND $\frac{3}{8}$ " LIP EXCEPT WHERE NOTED
SIDE - MAKE 2, BEND LIPS CORRECTLY FOR
RIGHT AND LEFT SIDES

Fig. 8. Side panel layout for Mobile-Marine Receiver.

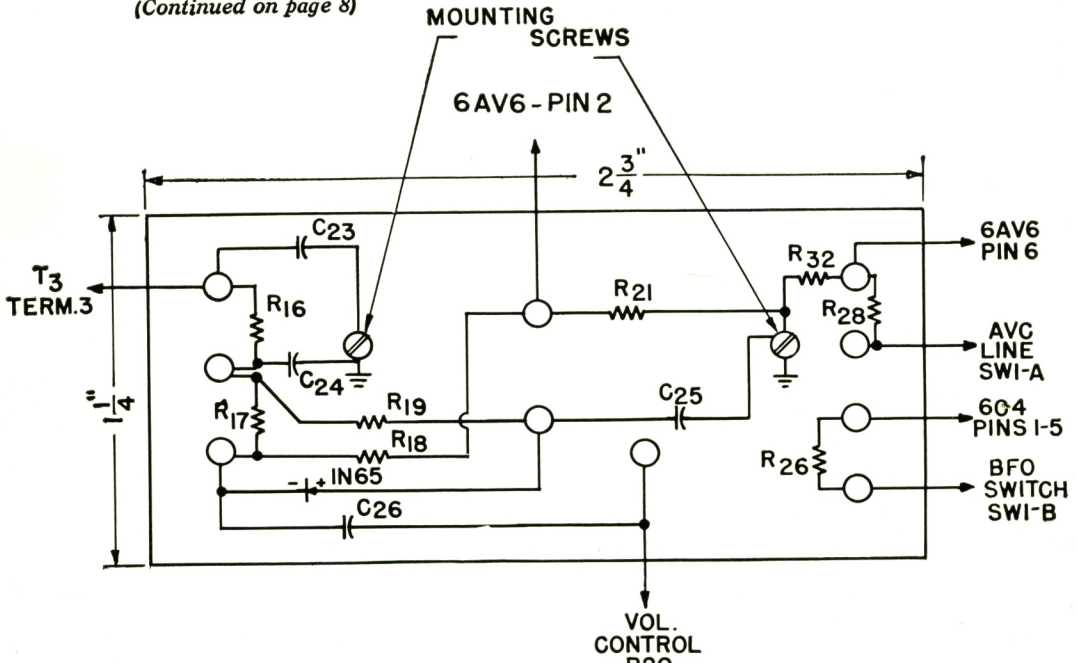
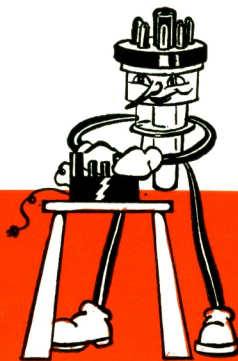
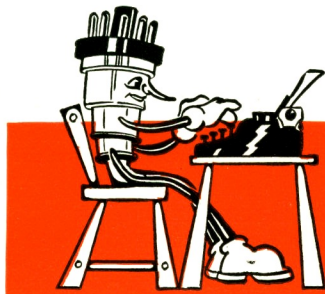

Fig. 9. Sub-assembly diagram.

SWEEPING *the* SPECTRUM



In the last issue, it was reported the G-E *Ham News* was starting its seventh year of publication. However, it was also George H. Floyd's (W2RYT) last issue as Editor of this publication. George has left us to accept another position within the Company. I believe I can speak for all of you readers to wish George the best of luck with his new adventure and congratulate him for the bang-up job he has done with G-E *Ham News*. If you fellows hear W2RYT on the band at anytime give him a call as he will be glad to have a QSO with you.

While we are saying our farewells to George we cannot help but reminisce somewhat of the beginning of this publication. It started back in the early part of 1946 when W2DC, Manager of Sales, Industrial & Transmitting Tube Department, was puzzling over the problem of how to reach more of the engineers, technicians, and repairmen in regard to G-E electronic tubes. It occurred to W2DC, that most of these fellows were also Amateurs, therefore, why not put out a publication for them. So with this in mind, George was given the assignment of originating and producing such a publication. Needless to say, he worked many hours in formulating and planning what to put out that would be different from other Amateur publications. The results were G-E *Ham News* and yours truly. (Incidentally, Lighthouse Larry is the modest little genius who answers all questions. You will find his picture at the top of this column. He was conceived by inverting a Lighthouse Tube and adding arms, legs, and facial expression. While his true name is Lighthouse Larry he has received some letters calling him other names, such as Lamp Post Larry, Lighthouse Harry, Light-post Harry, Hothouse Harry, and others which can not be printed. However he is addressed, he is always happy to hear from you fellows. Editor's note)

Perhaps some of you would like to know our policy on equipment described in G-E *Ham News* and who are on the unofficial staff. First of all the policy is very simple as you can see:

1—The equipment described must be of the type which the average Amateur can build and be reasonably assured of duplicating our results.

2—The equipment must not require a complete machine shop to construct it, but tools the average fellow has.

3—No complicated or trick circuits requiring laboratory equipment for proper alignment or test will be used.

4—Only standard components available from local parts distributor will be specified, unless, the designer feels it is absolutely necessary to use non-standard components to achieve maximum results.

5—The technical theory and design must be sound and practical.

6—All equipment must be tried and proven and undergo considerable test before it can appear in G-E *Ham News*.

Believe it or not fellows, as simple as this policy is it is sometimes difficult to meet. We have designed equipment which has not appeared in G-E *Ham News* because it was either too difficult to build or required laboratory equipment to test.

The unofficial staff, as we like to call it, consists of Amateurs who contribute part of their time and efforts. As you probably suspect, they are research associates and engineers of General Electric. Here are their call letters and names:

W2CCP	K. A. Bardin
W2FZW	S. G. (Ty) Reque
W2GYV	L. F. Jeffrey
W2KUJ	D. E. Norgaard
W2NOY	C. W. Bleichner
W2RKL	R. L. Watters
W2RMA	A. R. Koch
W2RYT	G. H. Floyd
W2UKL	A. H. Sharbaugh
W2WPV	R. L. Voeller
W2ZHI	W. N. Coffey
W4PFQ	A. P. Haase



While we are on the subject of G-E *Ham News* this seems like the proper time to answer those many requests as to how it may be obtained. This publication is available, free, from your nearest General Electric Tube Distributor. For those of you who find it difficult to obtain in this manner, a subscription plan is in effect. For \$1.00, G-E *Ham News* will be sent to you for one year. (This offer open only in continental USA, Alaska and Hawaii.) Address all inquiries and subscriptions to me, Bldg. 267, Tube Department, General Electric Co., Schenectady, N. Y.

— Lighthouse Larry

MOBILE MARINE RECEIVER

ALIGNMENT (Continued from page 6)

mixer tube, the slug in L_5 should be adjusted until a signal is heard. The signal generator is then connected to the antenna terminals and the slugs in L_1 , L_2 and L_3 , L_4 adjusted for maximum output. This procedure should be repeated several times to overcome any interaction between stages. After this has been completed, the low end of the band should be aligned. The main tuning condenser, C_2 , is set at maximum capacity. With the signal generator set at the low frequency desired (in the original receiver this was 2 megacycles) and connected to pin 1 of the mixer tube, adjust C_{11} until the signal is heard. The signal generator is then connected to the antenna terminals and the series padder condensers C_1 and C_8 adjusted for maximum output.

The complete high and low frequency alignment procedure should be repeated several times to make sure that each successive adjustment has not detuned the preceding one.

After the above procedure has been completed, tracking over the entire range should be checked. It may be necessary to adjust the parallel padders C_9 and C_{12} for proper tracking, however, in the original receiver these were set at maximum capacity and left alone. Fine tracking can be obtained by bending the plates of the tuning condenser, but again this was not found necessary.

If the tuning range is going to be restricted to the

80-meter band only, capacitors C_1 and C_8 should be changed to 4-50 uufd (ICA type 611 padders) and capacitor C_{11} changed to 12-120 uufd (ICA type 612 padder). This will bring the maximum capacity of the tuning combination down to a low enough value to spread the 80 meter band over the whole dial.

OPERATING INFORMATION

The operation of this receiver is all that could be desired. On-the-air listening tests have brought in all but the sixth and seventh districts using a six foot clip lead antenna on the cellar work bench at W2GYV. Even though the 80-meter band is crowded at the high end of the band, no difficulty was found in separating stations. The i.f. response was found to be approximately 7 kc wide at the half-power point and the curve had rather steep slopes indicating good adjacent channel selectivity.

The stability of the receiver is good enough to allow continuous monitoring of the Marine telephone stations for hours without retuning. Mechanically, it is sturdy enough to survive a sharp blow of the hand without shifting the tuning.

To those of you who build this receiver, be sure to use good quality parts and careful workmanship so that you can enjoy many happy hours of mobile operation.



Ham News

Available FREE from

G-E Electronic Tube Distributors

Printed in U.S.A.

A Bi-monthly Publication

TUBE DEPARTMENT, ELECTRONICS DIVISION

GENERAL ELECTRIC

SCHENECTADY 5, N. Y.

(In Canada, Canadian General Electric Company, Ltd., Toronto, Ont.)

R. L. VOELLER, W2WPV — EDITOR

FROM: