

7/21/57 GE

William C. Miller

# G-E HAM NEWS

Copyright 1954, by General Electric Company

TUBE DEPARTMENT  
**GENERAL ELECTRIC**  
Schenectady 5, N. Y.

NOVEMBER-DECEMBER, 1954

VOL. 9-NO. 6

## 600-WATT ALL-BAND AMPLIFIER

Push-pull 813's Ease Your Steps to Higher Power



There's no "easy" way to power—but this amplifier, designed and described by W2GYV, employs tested techniques and standard components to make the road to power as smooth as possible.

—Lighthouse Larry

➔ **Deadline for nominations for the Third Annual Edison Radio Amateur Award is January 3, 1955 . . . Pick a candidate and send in your nominating letter . . . see page 8.**

### CONTENTS

600-Watt All-Band Amplifier . . . . .	page 1
Sweeping the Spectrum . . . . .	page 7
To Honor Amateur Radio . . . . .	page 8



# 600-WATT ALL-BAND AMPLIFIER

## GENERAL DESCRIPTION

Here's a husky all-band final that does not utilize any new or trick circuits or any substantially different mechanical layout. It will be recognized from the circuit diagram and photographs as a conventional push-pull tetrode amplifier constructed in a straightforward manner. It illustrates the use of modern components and practical design.

In this complicated age, there is much to be said for an occasional attempt at simplification; and those seeking a respectable amount of power may find this amplifier fills their needs without emptying their pocketbooks or fraying their nerves during construction and testing.

The amplifier employs a pair of GL-813 tubes in a neutralized push-pull circuit. A multiband grid tank allows the input circuits to be permanently shielded and simplifies band-changing. The plate circuit uses standard plug-in coils which are easily accessible for band changing through the shielded and RF weather-stripped panel door.

No metering is provided in the amplifier itself. The incorporation of meters would make shielding and circuit isolation more difficult. It is much simpler and forthright to install grid, screen and plate current meters in a standard three-hole panel mounted elsewhere in the rack and connected in the power leads going from the amplifier after all RF has been filtered from them.

A regulated bias supply is included in the unit since with the low grid currents encountered it can be a simple affair and is something that would probably have to be built up in any event.

All controls, including input and output coupling, are conveniently located on the front panel. Coaxial connectors are used for the RF input and output and HV plug connectors for plate and screen leads. The grid meter and interlock circuit connections are made with two-contact microphone plugs mounted under a small shield on the rear of the chassis—thus making it a short and easy operation to disconnect all leads and remove the amplifier from its rack. The AC input—for bias and filament power—is through a cord and plug leading to the control unit shown in G-E HAM NEWS of March-April, 1954. (Volume 9, No. 2).

## CIRCUIT DETAILS

The only part of the circuit which may be out of the ordinary is the use of a four-section variable capacitor, C<sub>12</sub>, in the plate tank. This capacitor is adapted from a standard unit as explained under the constructional details and allows optimum L/C ratio to be achieved on all bands. It also makes tuning less critical on the three highest bands. The proper sections of the capacitor are selected automatically by jumpers on the coils between pins 1 and 2 and 7 and 8.

The plate coils are standard 500-watt units and although the amplifier has been run for extended periods at inputs of over 600 watts no undue heating of the coils was experienced. Jacks 3 and 6 on the coil socket were not used in this design.

The output is through a shielded link as specified. These links are available in 1, 2, and 3 turns. Generally, a 1-turn link is considered satisfactory at 10 meters, a 2-turn link at 15 and 20 meters, and a 3-turn link for 40 and 80. However, during tests, a 2-turn link was found satisfactory for all bands when working into a 52-ohm coaxial line. Experimentation is recom-

mended here as each antenna system may be slightly different. What works at one installation may not work well at another, even though the same general system is used, since one line may have a different standing wave ratio than the other. At any rate, link coupling of this sort is probably the easiest of all coupling devices to adjust.

The vacuum capacitors C<sub>6</sub> and C<sub>11</sub> are for the purpose of providing a short low impedance path for the higher harmonics which might cause TVI. It should be pointed out that they are not necessary to the normal satisfactory operation of the amplifier and may be omitted if TVI is not a problem.

Don't be misled, however, into thinking that these capacitors themselves will be a complete cure for all TVI. They are an aid in stubborn cases and you may well want to try the amplifier before installing them. However, the vacuum capacitors are part of the total plate tank capacitance and the coil modifications given in the coil table are based on their use. Leaving them out may not necessitate the coil modifications listed under "Coil Data."

The neutralizing capacitors, C<sub>2</sub> and C<sub>5</sub>, were found necessary to completely stabilize the amplifier. All normal checks failed to reveal the need for neutralizing; but on checking the amplifier for stability by operating it at zero bias, no RF drive, and with plate and screen voltages adjusted to give rated static plate and screen dissipation, it was found that a weak oscillation would occur when both grid and plate were tuned to the same frequency. The neutralizing wires were then adjusted until this did not occur. This should be done with the 10 meter coils in place and will then hold for all-band operation. The neutralizing wires are made from No. 14 copper wire and are brought through the chassis approximately one inch from the tubes. Small ceramic feed-through insulators were used for this purpose. Start off with wires reaching to the tops of the tube anodes and adjust them by clipping off 1/2 inch at a time until a length is found which will give complete neutralization. Fine adjustment is made by changing the spacing between wires and tubes by means of an insulated rod through the 1/4-inch holes in the back of the shield.

The bias supply is conventional. It utilizes a GL-OA3/VR75 tube for regulation and so furnishes 75 volts of fixed bias. The remaining bias is developed across R<sub>1</sub> by the flow of grid current. This resistor may be seen in the photographs on top of the bias supply sub-chassis. The remaining resistors and selenium rectifier are mounted under this sub-chassis. The 75 volts is more than sufficient for plate current cutoff, allowing the driver to be keyed for CW work provided the screen is supplied from a fixed supply or from a voltage divider from the HV plate supply. Do not attempt CW operation if the screen is supplied through a dropping resistor.

Liberal use has been made of by-pass capacitors and RF chokes. All of these precautions make for stable, trouble-free operation and are well worth their cost.

An interlock switch S<sub>1</sub>, is provided to protect the absent-minded when changing coils. It should be connected in the power supply in such a manner that the primary voltage to the plate supply is removed when the door is opened. The micro-switch used is a SPDT switch and should be connected so that the switch opens the circuit when the door is open. In addition, provision should be made for shorting the high voltage



lead to discharge the filter capacitors before changing coils. Make up a shorting stick NOW. AND USE IT! A fellow isn't even allowed one mistake at these voltages!

#### MECHANICAL DETAILS

Much thought and time was given trying to evolve some novel and suitable mechanical layout—something that would be eye-catching and efficient. In fact, the whole project was delayed several months because of this. Several unique ideas were dreamed up but discarded because they were too expensive, too difficult to construct without metal-working facilities or else they just shouted over-design.

The old standby of chassis and panel construction proved to be not only the easiest to handle with the usual facilities but also promised to fit into most modern station layouts.

The biggest problem (and it was small compared to some of the layouts that were considered) was that of getting the plate tank capacitor and link controls out to the front panel. The solution was found with standard components. The capacitor is driven with a right-angle drive unit, two universal joints, and some  $\frac{1}{4}$ -inch diameter shaft. Panel bushings are used wherever the shaft goes through the chassis or panel. The link control required only two flexible shafts. The arrangement should be evident by inspecting the photographs.

The parts layout is also clearly shown and no detailed drawings are given. The multiband tank is mounted on spacers so the tuning and link shafts are centered on the lower section of the front panel.

The bias supply is built on a separate sub-chassis easily shaped and mounted as shown and there is nothing critical about the placement of parts. The sub-chassis is fastened to the side of the main chassis by two screws in front and by the feed-through capacitors, C<sub>20</sub> and C<sub>22</sub> on the rear apron of the main

chassis. The AC line filter capacitors, C<sub>25</sub> and C<sub>27</sub> are mounted on the bias chassis and project through the main chassis in close-fitting holes.

Ventilation is provided through the panel door and the vent holes over each tube. Natural draft provides sufficient air to prevent overheating of the tubes.

#### CONSTRUCTIONAL DETAILS

All components are mounted as shown in the photographs on a 13 x 17 x 4-inch aluminum chassis. Aluminum is recommended rather than steel as it is both easier to work and will not rust in damp locations. Even a plated steel chassis will rust around the drilled holes. No special precautions are necessary in the layout that cannot be observed in the illustrations.

The front panel calls for special attention if satisfactory shielding is to be achieved. The panel used is a 12 $\frac{1}{4}$ -inch Par-Metal Grille Door Panel (Cat. No. G-682). In making the panel RF-tight, the paint was removed by soaking the entire panel in paint remover and then rinsing well. After this was done, the panel was copper-plated. While plating is not absolutely essential it will result in a more permanent shielding job.

After plating, a piece of standard bronze insect screen was carefully soldered to the inside of the grill door.

The next operation was to install the RF weather stripping. The particular material used was made by Instrument Specialties Co., Little Falls, N. J. (Cat. No. 97-112-H). This material is  $\frac{7}{8}$ -inch-wide beryllium copper strip with  $\frac{1}{8}$ -inch wide fingers, 5 $\frac{1}{2}$  fingers per inch. Similar stripping of other manufacture could also be used satisfactorily. This strip is held to the panel by a  $\frac{1}{2}$  x  $\frac{1}{2}$ -inch aluminum angle running completely around the sides and top of the door opening and secured to the panel with brass machine screws.

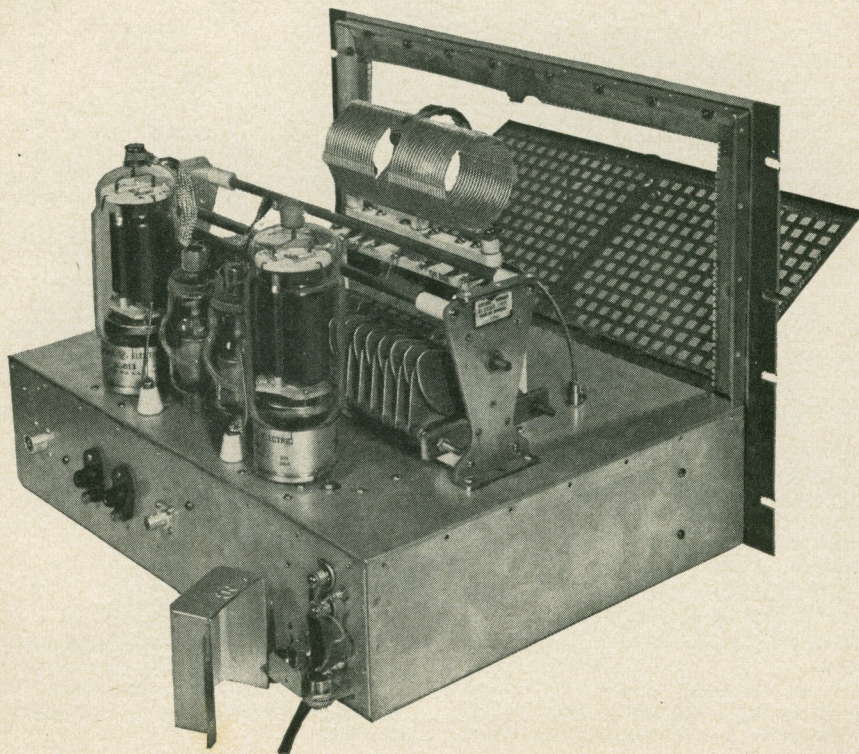



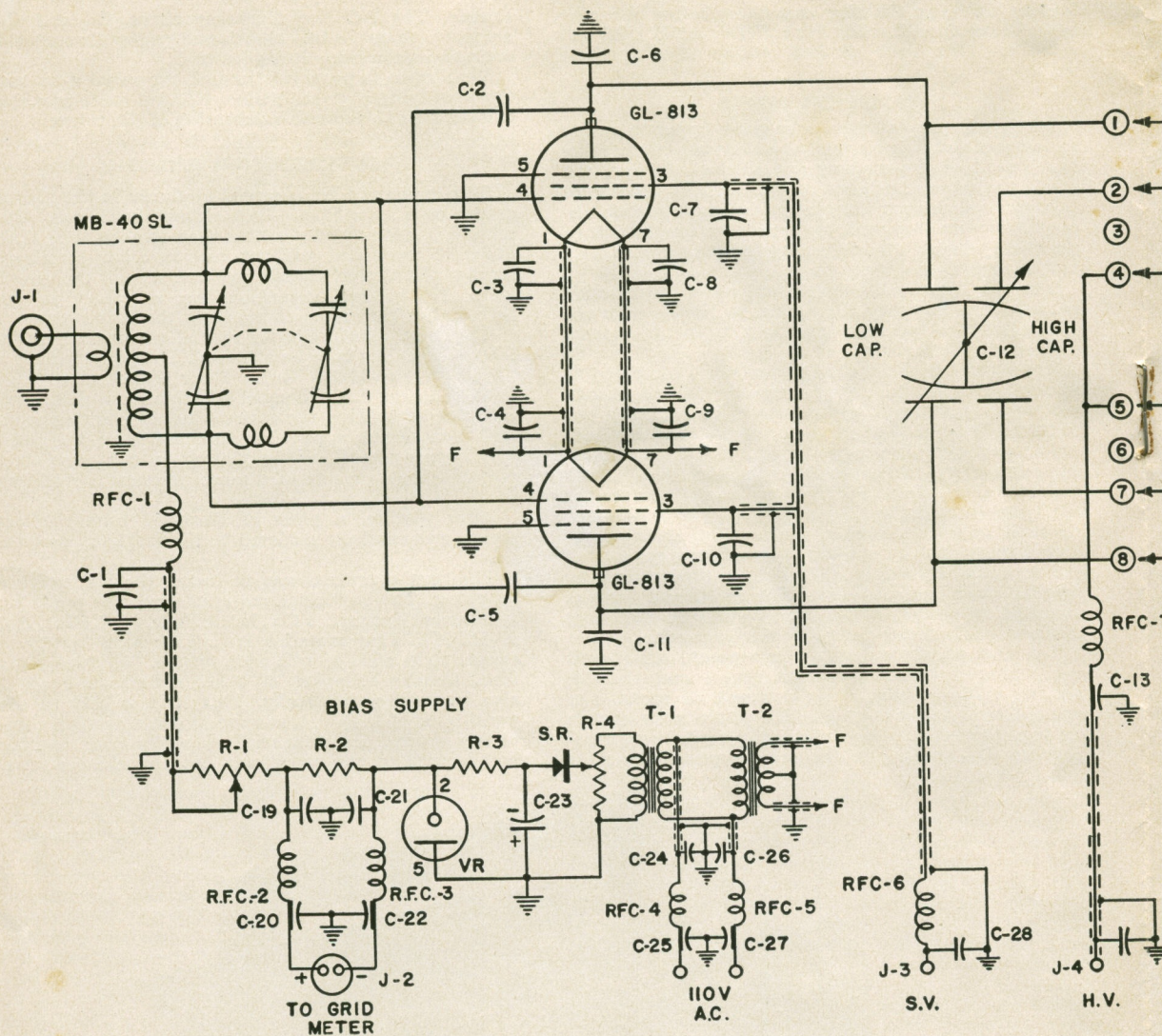

- C<sub>1</sub>, C<sub>3</sub>, C<sub>4</sub>, C<sub>8</sub>, C<sub>9</sub>**—.002 mfd. disc ceramic (Centralab DD-202)  
**C<sub>2</sub>, C<sub>5</sub>**—Neutralizing wires (see text)  
**C<sub>6</sub>, C<sub>11</sub>**—12 mmf. vacuum capacitor (GL-1L21 or 1L25)  
**C<sub>12</sub>**—100 mmf. per section, split stator. (Bud 1633A modified as described in text.)  
**C<sub>7</sub>, C<sub>10</sub>, C<sub>28</sub>**—.0005 mfd., 1000-volt mica (Sprague 3CFM-35)  
**C<sub>13</sub>**—.002 mfd., 5 KV (Sprague Hypass 47P16)  
**C<sub>14</sub>**—500 mmf., 20 KV ceramic (Sprague 20DK-T5)  
**C<sub>15</sub>, C<sub>16</sub>, C<sub>17</sub>, C<sub>18</sub>, C<sub>20</sub>, C<sub>22</sub>**—.001 mfd., 500-volt ceramic feed-thru (Centralab No. FT-1000)  
**C<sub>19</sub>, C<sub>21</sub>, C<sub>24</sub>, C<sub>26</sub>**—.001 mfd., disc ceramic (Centralab DD-102)  
**C<sub>23</sub>**—10 mfd., 450 VDC electrolytic (Sprague EL-1)  
**C<sub>25</sub>, C<sub>27</sub>**—0.1 mfd., 250 VAC (Sprague Hypass 48P9)  
**R<sub>1</sub>**—5000-ohm, 25-watt, adjustable wire-wound  
**R<sub>2</sub>**—100-ohm, 2-watt  
**R<sub>3</sub>**—10,000-ohm, 5-watt, wire-wound  
**R<sub>4</sub>**—25,000-ohm, 25-watt, adjustable, wire-wound  
**T<sub>1</sub>**—Thordarson T-22R12, 117/120, 6.3-volt; selenium rectifier

- power transformer. (6.3-volt winding not used.)  
**T<sub>2</sub>**—Thordarson T-21F19, 10-volt, 12-amp. filament transformer  
**SR**—100 ma., 135-volt selenium rectifier (GE-6RSSGH1A)  
**MB-40SL**—National multiband tank unit  
**L<sub>1</sub>**—B & W type TVH, 500-watt coils.  
**L<sub>2</sub>**—B & W shielded link No. 3282.  
**J<sub>1</sub>**—UG—90/U, BNC connector  
**J<sub>2</sub>, J<sub>6</sub>**—Amphenol 80-PC2F locknut receptacles.  
**J<sub>3</sub>, J<sub>4</sub>**—Millen 37001 HV connector  
**J<sub>5</sub>**—SO-239, UHF connector  
**S<sub>1</sub>**—Microswitch (BZ-RQ1)  
**RFC<sub>1</sub>**—2.5 mh RF choke  
**RFC<sub>2</sub>, RFC<sub>3</sub>, RFC<sub>6</sub>**—Ohmite Z-50  
**RFC<sub>4</sub>, RFC<sub>5</sub>**—25 turns, 1/4" diameter, No. 16 en., close wound, self-supporting.  
**RFC<sub>7</sub>**—4 mh, 750 ma. (Miller No. 4336)  
**VR**—GL-OA3/VR75 voltage regulator tube



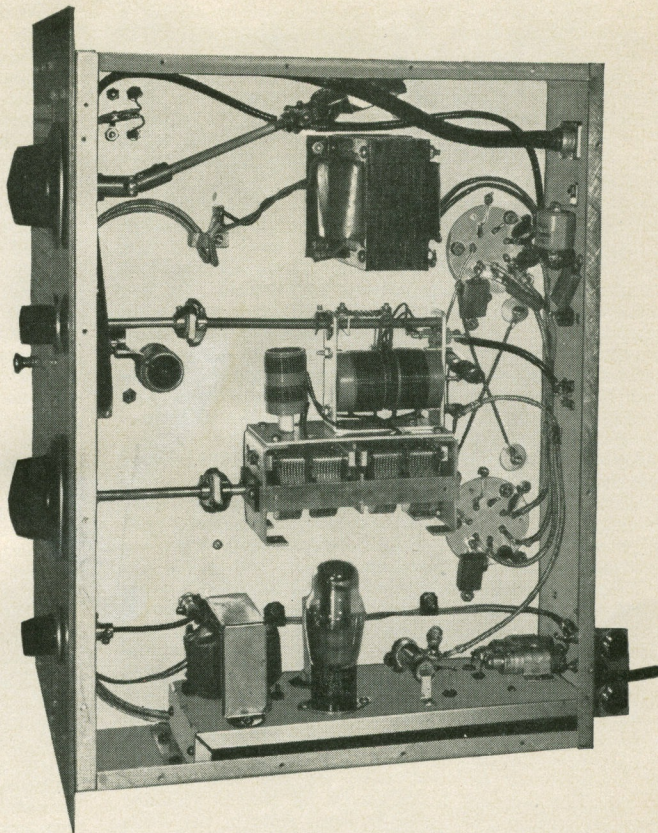
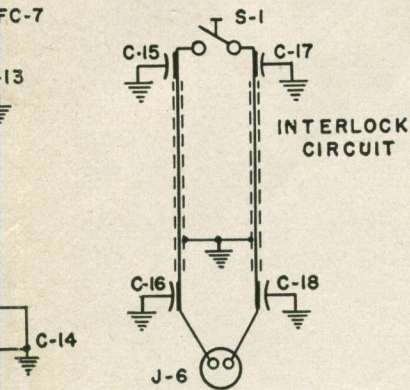
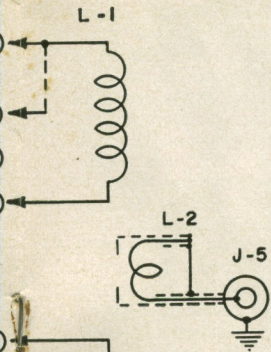

Bottom view clearly shows placement of components. Note RG-8/U output link runs from output connector at top right of picture around upper edge and down to similar connector at left center. Bias supply components mounted on sub-chassis. In close-up picture (below) note RFC<sub>7</sub>, mounted underneath final tank coil. This view also shows lugs added to tank tuning capacitor when modified as described in text.

### PLATE TANK COIL DATA

- All coils B & W TVH, 2½-inch inside diameter
- 80—38 t. No. 14 spaced to 5¼-inch length with ¾-inch separation in center. (Jumpers between pins 1 & 2 and 7 & 8.)
  - 40—24 t.; other specifications same as 80-meter coil, including jumpers.
  - 20—12 t. No. 12 spaced to 4¾-inch length with ¾-inch separation in center. (TVH with one turn removed from each end.)
  - 15—8 t. of ½-inch d. wire or tubing spaced to 6-inch length with ¾-inch separation in center. (TVH with one turn removed from each end.)
  - 10—4 t. of ½-inch d. wire or tubing spaced to 3-inch length with ¾-inch separation in center. (TVH with two turns removed from each end.)

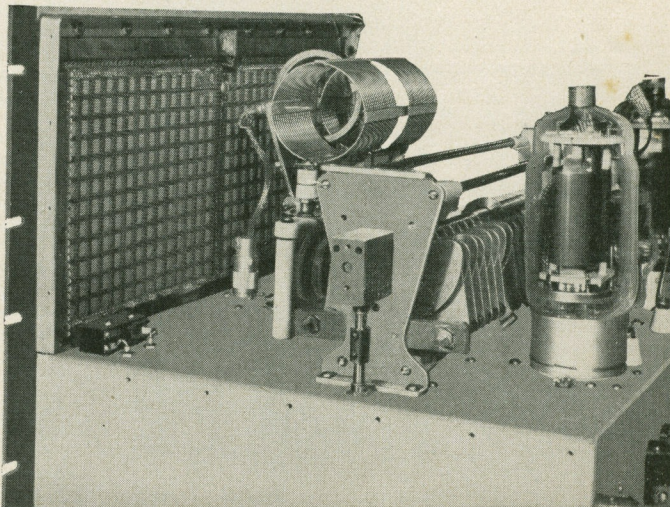



This angle serves the dual purpose of providing a support for the cover as well as holding down the RF weather strip.

The chassis cover is made of 1/16-inch soft aluminum, bent by clamping it over the edge of a work bench using a piece of angle iron and two "C" clamps. Lips should be bent on the edges of the back to be bolted to the sides after all bending is completed. Self-tapping screws are used to hold things together here. The ventilation holes over the tubes should be drilled before the cover is bent. (Those who notice the photographs show a plate with vent holes bolted over two large holes in the top of the shield are asked to excuse a mistake made during construction. It was intended to drill a fancy design in the top for vent purposes but the drill unfortunately slipped. Again, we recommend simplicity!)

The chassis for the bias supply was conveniently formed over a short length of 2 x 4-inch lumber. This made it exactly the right width and also furnished a back-up block for drilling operations.

Do not skimp on the number of screws used in holding the shielding together. Any gaps in the joints provide a chance for RF to leak out. The bottom plate should be fastened with several self-tapping screws along each edge rather than with the screws in each corner as provided by the manufacturer.

Two 1/4-inch diameter holes should be drilled in the back opposite the neutralizing wires for later use in adjusting the neutralization.

After the construction and wiring is complete, the outside of the panel and the cover can be painted with a hard machinery enamel.

After all mechanical details are complete, the amplifier may be wired. Shielded wire was used exclusively—RG-58/U coax for the high voltage leads and ordinary single-conductor shielded wire for the low voltage wiring. The filament leads should be No. 14 shielded wire. Ground the shielding at both ends of the leads and wherever else it may be convenient.

Lead lengths on all by-pass condensers should be kept as short as possible.

The Sprague Hy-Pass capacitor used for  $C_{13}$  was considered desirable as it allowed the return to be made to the under side of the chassis, providing a short and direct path to the cathode. If it were made to the top of the chassis, the RF would have to find its way through the chassis in order to complete the circuit to the cathodes and could well result in instability due to incomplete plate by-passing. This capacitor is mounted through a snug-fitting hole and held in place by a small brass angle on the underside of the chassis. This angle also provides the ground connection for the capacitor.

The interlock circuit and grid current meter terminals are protected by an aluminum cover cut from a coil shield can.

#### MODIFYING THE PLATE CAPACITOR

The modification of the plate tuning capacitor requires some careful workmanship. The capacitor, before modification, consisted of two sections—each with ten stator plates. The seventh stator plate from each end was removed by sawing through the support rods 1/4-inch from each side of the plates. Next, four pieces of 1/2-inch diameter insulating rod (mycalex was used) were cut to fit exactly the gaps left between the sixth to eighth plates. The ends of these insulating spacers were drilled and tapped to take the threads of the stator support rods. No changes were made in the rotor assembly. This left a capacitor having four separate stator sections—the two inside sections consisting of three plates each, and the two outside sec-

tions six plates each. Suitable heavy solder lugs, visible in the photographs, are inserted between both ends of the insulated rod and adjacent plates to allow connections to be made to the stators.

The shielded link is plugged into an SO-239 coaxial connector mounted on top of the chassis, to allow the link line to feed through the chassis and connect to the output connector on the rear apron. Both connectors are shielded where the coaxial jumper connects by means of standard receptacle hoods designed for this purpose. The shielded link is supplied with a pair of shielded leads. To use the link with coaxial circuitry, it is necessary to connect one inner conductor to the shielding braid right at the link, leaving a single shielded lead for connection (see circuit diagram).

The bases of the GL-813's are grounded to the chassis by small metal clips from a socket for a GL-4-250A. Since these may not be readily available, a suitable clip can be made from spring brass or bronze.

#### TUNING UP

The first step in getting the amplifier into operation is to set the bias voltage. This can best be done before the supply is fastened in place. After checking to be sure all wiring is correct, apply power and adjust  $R_4$  for a current of 5 milliamperes through the VR tube. The easiest way to check this is to measure the voltage drop across the 10,000-ohm series resistor,  $R_3$ , using a VTVM or high resistance DC voltmeter. This will be 50 volts DC for 5 milliamperes of current. Bias resistor  $R_1$  should be set at 3500 ohms for a plate supply voltage of 1600 volts and 3000 ohms for 2000 volts. If only CW operation is contemplated, set  $R_1$  at 2500 ohms. The higher values will be satisfactory for both phone and CW work but it is recommended that slightly lower grid drive be used on CW, approximately 7 milliamperes per tube. It is good practice to use the minimum amount of drive for full output under all conditions as an aid to keeping down harmonic generation.

Neutralizing should be accomplished as explained under "Circuit Details" *only* if fully adjustable plate and screen voltages are available. Otherwise it should be done in the conventional manner by coupling a sensitive RF indicator to the plate tank and adjusting the neutralizing wires for minimum output.

It is recommended that all wiring to the power supplies and meters be shielded and the shields grounded at both ends.

Several methods of obtaining screen voltage are possible. A series dropping resistor from the plate supply may be used for phone work only or a voltage divider across the plate supply could be used for CW. The method used with this final was a fixed supply of 350 to 400 volts with choke output consisting of a standard 10-henry filter choke. This method allows the screens to modulate themselves and has the added advantage of not requiring any changes for CW work. When going from phone to CW it is only necessary to turn off the modulator supply and short the secondary of the modulation transformer.

This amplifier has proved itself in all respects. It is easy to build; provides a good quality signal; and offers sufficient power to compete with the best.

#### PARASITICS

In the 220-megacycle converter in the September-October 1954, issue of G-E HAM NEWS (Vol. 9, No. 5), coils  $L_1$ ,  $L_2$ ,  $L_4$  and  $L_{10}$  should be wound on 1/4-inch forms instead of 1/2-inch forms as described in the parts list. Also,  $RFC_5$  should have 15 turns, instead of 5.



# SWEEPING *the* SPECTRUM

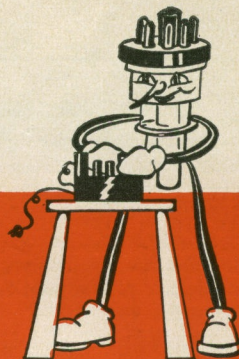
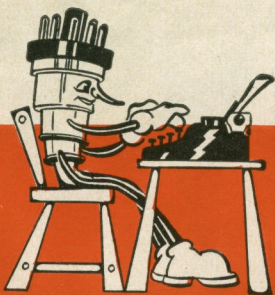

Hey, fellows, don't forget the deadline for entering nominations in the Third Annual Edison Radio Amateur Award is January 3, 1955. Complete rules are on page one of the September and October issues of QST and page one of the September issue of CQ. The award means not only acclaim for the winner and recognition for the person responsible for his nomination—but also the Award gives ham radio a big boost. Get those nominations in.



CD workers may be interested in the following article by VE4BN in "Sparks," published by the Brandon (Manitoba) Amateur Radio Club.

"During the last war the enemy had a CD communications system—one of the most extensive nets I ever had the opportunity to monitor. The number of stations on this net was amazing. The area covered was massive—from Channel to Baltic in the north, along the Russian front, south to Italy, along the Mediterranean, and all the land between. Guess what band this operation took place on . . . long-wave. Down around 170 kcs.

"The operators were good, the discipline rigid—and unauthorized transmissions were nil. The activity that took place on this net after an Allied raid on the Ruhr was feverish in its intensity. All traffic was coded, not high-grade cypher, and not for security's sake—but for speed in transmission. These messages were requests for medical, fire fighting aid, etc. The transmitters were VFO, several stations could work at once by going up or down in frequency, and still be very close to net frequency. This can only be accomplished on long-wave. And guess the mode of operations . . . CW."



One letter out of ten—and we get more than a thousand here in the course of a year—asks how to change one of our circuits in order that a slightly different component can be used or so the piece of equipment will do something a little different than what it was designed for.

These are not easy letters to answer in most cases. We want to help all we can. But, as we have written to countless fellows, it simply is not possible for us to enter into a design or re-design project upon individual request. Usually, it's not only that the design or re-design calculations take a lot of time (we build each piece of equipment on paper before touching a drill or soldering iron) but, also, it's a matter of responsibility.

We simply can't afford to make some calculations and then pass this information on to someone else to carry through. For we stand behind every design we publish; and that means we have built the piece of equipment—often several models of it—and tested it thoroughly. So we know it works the way we say it does.

Now for us to go back somewhere near the beginning of the job and make some design changes so the equipment will operate a little differently—and still guarantee operation—may not sound like a big project. But sometimes we can't tell how big a project such a change is until we also carry through with perhaps new construction and new conditions and complete a series of tests on the new design. And this, as I said before, we cannot do on individual request. So, in most cases, we are forced to reply by saying simply that we are sorry but the design has been worked out to do that particular job in that particular way, and with those particular components—and in making changes and substitutions you'll be on your own.



Good dynamic regulation in a power supply (see G-E HAM NEWS, Volume 9, Nos. 1 & 2) is particularly important in an SSB transmitter to obtain the peak output of which the amplifier is capable. And with so many fellows turning to SSB (over a thousand, according to what we hear), the question continually has come up as to just what practical advantage you get with 100 or so microfarads of capacity in your power supply filter. In other words, a lot of fellows ask if 20 or 30 microfarads won't do just as well in practical operation.

The answer lies in the oscillograms of our issue of Volume 9, No. 1. They show the sort of dynamic regulation you get with varying amounts of capacity. They show how performance improves continually as you add capacity. You will note, however, that the performance has improved tremendously by the time the capacitance reaches a value of 45 microfarads. After that, although the improvement continues with additional capacitance, the improvement naturally is smaller.

Now when you get into this latter region—the region where, quantitatively, the improvement is small—the effect on practical operation of your transmitter begins to depend to a larger and larger degree on just how well the rig is working in other respects. In other words, if everything else in the transmitter is otherwise capable of ideal performance, the best dynamic power supply regulation obtainable is necessary to exploit this capability. On the other hand, if the rig's capability is limited, the improvement brought about by the last 50 microfarads or so of filter capacity will not make a great difference in practical on-the-air operation.

What it all boils down to is this, as we said in Volume 9, No. 2: "It is difficult to see how one can get too much capacity built into the power supply." This means, of course, you should put in all the capacity you can get hold of—but don't starve the XYL and Jr. op in the process of buying filter capacitors.

—Lighthouse Larry



## To Honor Amateur Radio

### FOR OUTSTANDING PUBLIC SERVICE

Nominations now are open for the Third Annual Edison Radio Amateur Award—to be granted for outstanding public service by a United States amateur in 1954. The deadline is January 3, 1955.

Any individual or group may nominate a candidate for this Award. Letters of nomination should include all details of the public service performed, and should be mailed to:

Edison Radio Amateur Award Committee  
Tube Department  
General Electric Company  
Schenectady 5, New York

Judging will take place in mid-January and presentation of the Award and prize will follow shortly thereafter. Judges for the 1954 Award are:

Val Peterson, Administrator, FCDA  
E. Roland Harriman, President, Red Cross  
Edward M. Webster, Commissioner, FCC  
Goodwin L. Dosland, President, ARRL

Detailed Award rules are listed on page one of QST magazine for September and October and CQ magazine for September. A copy of these rules will be mailed to anyone upon request.



## G-E HAM NEWS

Available **FREE** from

G-E Electronic Tube Distributors

published bi-monthly by

TUBE DEPARTMENT

GENERAL  ELECTRIC

Schenectady 5, N. Y.

In Canada  
Canadian General Electric Co., Ltd.  
Toronto, Ontario

S. E. McCALLUM, W2ZBY—EDITOR



Electronic  
TUBES

Printed in U.S.A.

Vol. 9 - No. 6

NOVEMBER - DECEMBER, 1954