

**UTC** class B audio and power components are available for every type of transmitter. Thorough research, expert engineering design and exacting laboratory checkups are responsible for the enviable reputation of UTC products.

## High Fidelity Hiperm Alloy Audio Components for Portable Pre-Amplifier and Remote Pickup Applications



Specifically designed for portable use. Extremely compact and light in weight. Smallest high fidelity transformers available. Made possible through the development of HIPERM ALLOY, a nickel iron alloy having extremely high initial permeability.

### WHY UTC CLASS B AUDIO TRANSFORMERS ARE BETTER

All units are designed to operate at maximum efficiency, and designs have actually been developed and proven in operating circuits. All coils are accurately balanced and multiply interleaved. Intelligent sectionalizing of windings and proper impedance relationships reduce losses in both frequency and efficiency. Selected core materials are operated at proper flux densities to keep out harmonic distortion other than that incident with Class B tubes.

#### INPUT DRIVER TRANSFORMERS TO CLASS B GRIDS

Type	PURPOSE	List price	Case #
PA-50	Driver plate to 49, 53, 79 or 89 grids	\$5.50	PA-1
PA-51	Driver 46 or 59 plate to 46 or 59 grids	5.50	PA-1
PA-52	Push-pull 46 or 59 plates to 2-46 or 2-59 grids or push-pull 2A3 plates to 2-841 grids	6.50	PA-2
PA-53	Push-pull 42, 46, 50 or 59 plates to 2-242A's, 2-800's, 2-830's, 2-RK-18's, or 2-210 grids	7.50	PA-2
PA-54	Push-pull 2A3 plates to 2-203A grids	8.50	PA-2
PA-55	500, 200 or 50 ohm line to 2-46 or 2-59 grids	7.50	PA-2
PA-56	500, 200 or 50 ohm line to 2-203A grids	10.00	PA-2
PA-57	Push-pull 2A3 plates to 2-830B's, 2-800, 2-RK-18 or 2-210 grids	7.50	PA-2
PA-58	Driver 2A3 or 42 triode plate to 2-A Prime, 2A3 or 42 grids	5.50	PA-2
PA-59	500, 200 or 50 ohm line to 2-830B, 2-800, 2-RK-18 or 2-210 grids	7.50	PA-2

#### CLASS B OUTPUT TRANSFORMERS TO RF LOAD

Type	Primary Load Impedance	Will Match	Secondary Load Impedance	List price	Case #
PA-20	10,000 ohms plate to plate or 6,000 ohms plate to plate	For 10,000 ohms, class B, 49's, 53's, 79's, 89's; for 6,000 ohms, class B, 46's, 59's	5,000, 3,500 ohms	\$7.00	PA-2
PA-71	6,000 ohms plate to plate	Class B, 46, 59's	14,000, 3,500 ohms	7.00	PA-2
PA-70	8,000 ohms plate to plate	A Prime, 42's	5,000, 3,500 ohms	7.00	PA-2
PA-60	6,000 ohms plate to plate	Class B, 203's	3,000, 2,500 ohms	30.00	PA-4
PA-82	10,000 ohms plate to plate or 6,000 ohms plate to plate	Class B, 203's, 830B's	10,000, 2,500 ohms	32.50	PA-4
PA-81	12,500 ohms plate to plate	Class B, 800's, RK-18's	5,000, 3,000 ohms	20.00	PA-4
PA-82	12,500 ohms plate to plate or 8,000 ohms plate to plate	For 12,500 ohms, class B, 800's, RK-18's; for 8,000 ohms, class B, 242A's, 211E's	20,000, 5,000 ohms	25.00	PA-4
PA-83	8,000 ohms plate to plate	Class B, 210's, 830's, 841's	18,000, 4,500 ohms	12.50	PA-3

#### CLASS B INPUT SWINGING CHOKES\*

Type	Swinging Action	Current Range	Maximum DC Oper. Voltage	Ohmic DC Resistance	List price	Case #
PA-101	5 to 25 henrys	15 to 150 MA	450	115	\$5.00	PA-2
PA-103	5 to 25 henrys	20 to 200 MA	600	110	8.00	PA-3
PA-105	6 to 30 henrys	25 to 250 MA	1300	90	12.00	PA-3
PA-107	20 to 100 henrys	25 to 250 MA	2600	240	20.00	PA-4
PA-109	5 to 25 henrys	75 to 500 MA	1300	60	20.00	PA-4

#### TRAP RESONANT SMOOTHING CHOKES\*

Type	Inductance	DC Output	Ohmic Resistance	List price	Case #
PA-100	8 henrys	150 MA	115	\$5.00	PA-2
PA-102	10 henrys	200 MA	110	8.00	PA-3
PA-104	12 henrys	250 MA	90	12.00	PA-3
PA-106	35 henrys	250 MA	240	20.00	PA-4
PA-108	10 henrys	500 MA	60	20.00	PA-4

\*Test voltage is twice operating voltage plus 1000 volts. Smoothing chokes have an off-center tap for hum-bucking arrangements. The chokes so used produce a highly filtered rectified DC output. UTC distributors will allow hams a discount of 40% on UTC products listed on this page.

The UTC HIPERM ALLOY audio transformers are described in the new U-1000C bulletin. Send for Your Copy Today

The new 1000-B Bulletin is ready



Send for your FREE Copy Today

16 PAGES OF VALUABLE DATA COVERING NEWLY DESIGNED AND TESTED HIGH FIDELITY AND WIDE RANGE AMPLIFIER CIRCUITS

## UNITED TRANSFORMER CORP.

Export Division, 15 Laight St., New York, N. Y.  
264-266 CANAL STREET NEW YORK, N. Y.

Exclusive Pacific Coast Distributors Carrying a Complete Stock of UTC Products  
UPPER CALIFORNIA LOWER CALIFORNIA

Offenbach Electric Co. 1452 Market St., San Francisco  
E. C. Wenger Company 1029 Oak St., Oakland  
Wholesale Radio & Electric Supply 271 Ninth St., San Francisco  
SEATTLE, WASH.—Seattle Radio Supply Inc. 2319 Second Ave.  
Portland Radio Supply Co. 1300 W. Burnside, Portland, Ore.

Pacific Radio Exchange Inc. 729 S. Main St., Los Angeles  
Radio Supply Co. 312-14 S. Broadway, Los Angeles  
Coast Electric Co. 744 G St., San Diego  
Frest & Dean Radio Co. 400 American Avenue, Long Beach

25c [ 30c in Canada ]

JULY, 1934

\$3.00 PER YEAR BY SUBSCRIPTION

# RADIO

ESTABLISHED 1917

SHORT-WAVE AND EXPERIMENTAL

- IN THIS ISSUE -

5 - METER TRANSCEIVERS  
DIRECTIVE ANTENNAS FOR AMATEURS  
THREE-TUBE SUPERHETERODYNE  
A MINIATURE RELAY-RACK RECEIVER  
A 100-WATT, LOW-COST, 3-BAND PHONE

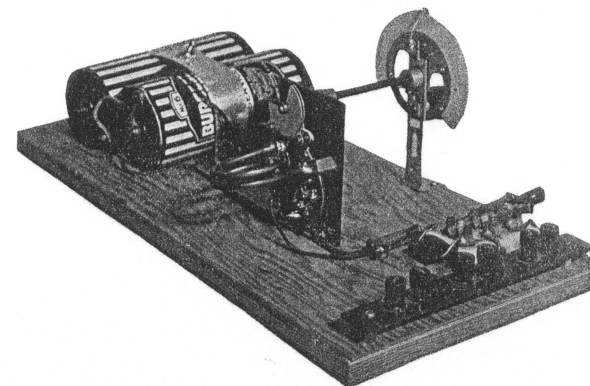

★  
One-Tube  
5-Meter  
Transceiver  
Designed  
by Frank  
C. Jones

FEATURE ARTICLES By . . .

Clayton F. Bane - - Frederick Emmons Terman - - R. S. Kruse - - Norris Hawkins  
George B. Hart - - I. A. Mitchell - - W. W. Smith - - Frank C. Jones  
Col. Clair Foster

RADIOTELEPHONE DEPARTMENT - - HAM HINTS - - TUBE TECHNIQUE  
AMPLIFIER DATA - - - D-X NEWS - - - "SCRATCHII"

# Individuality... Progress!

## GRAPHITE ANODE TRANSMITTING TUBES

by  
*Sylvania*

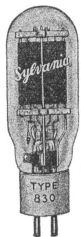

Every single type of SYLVANIA GRAPHITE ANODE transmitting tube represents a complete and exclusive SYLVANIA achievement—not a mere copy of an old conventional design. The eye immediately notes the rugged, clean cut, and original design of these ultra-modern SYLVANIA tubes.

A distinctly improved line of standard transmitting tubes—leading the field—that is SYLVANIA.

Convincing evidence of SYLVANIA engineering progress and transmitting tube superiority is seen in the wide-spread use of SYLVANIA transmitting tubes among broadcast stations. Broadcast engineers, of necessity extremely critical and exacting, now generally concede that SYLVANIA tubes are superior. They are rapidly replacing the old, conventional tubes in broadcast transmitters. Today more than 35% of our American broadcast stations use SYLVANIA transmitting tubes. Stations small and large—from 50 watts to 50 kilowatts—are now using these tubes to the extent shown in the following table:



Power Ratings	Number of Existing Stations in each Power Class	Number of Sylvania Equipped Stations in each Power Class
50 Watts	11	3
100 "	196	72
250 "	69	18
500 "	116	56
1,000 "	115	46
2,500 "	25	1
5,000 "	15	5
10,000 "	11	4
25,000 "	5	1
50,000 "	24	5

Amateurs, the world over, are enthusiastic and were among the first to "discover" these tubes. The whole field is talking about SYLVANIA GRAPHITE ANODE tubes—they are saying good things about them.

You, too will be a SYLVANIA enthusiast once you have used these dynamic SYLVANIA GRAPHITE ANODES. Install them in your station now and enjoy the low cost per hour performance that only SYLVANIA GRAPHITE ANODE transmitting tubes can give.

Engineering information may be obtained by writing to the Amateur Radio Division, Electronics Department, Clifton, N. J.

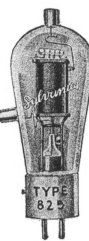

## HYGRADE SYLVANIA CORPORATION

HYGRADE LAMPS

FACTORIES:  
SALEM, MASS.

AMATEUR RADIO DIVISION  
ELECTRONICS DEPARTMENT  
CLIFTON, N. J.

EMPORIUM, PA.



ST. MARYS, PA.

SYLVANIA TUBES

CLIFTON, N. J.

BRANCH OFFICES:  
New York City,  
253 W. 128th St.  
Tel. MOnument 2-2812  
Boston,  
J. H. Condon,  
6 Marlboro St.  
Chicago,  
C. W. Nelson,  
3618 North Bernard St.  
Los Angeles, Calif.  
1455 Glenville Drive.  
Tel. CRestview 4017

# RADIO

ESTABLISHED 1917 Reg. U.S. Pat. Off.

A NATIONAL MAGAZINE - PUBLISHED MONTHLY

Publication Offices—Pacific Building, San Francisco, California

Clayton F. Bane, Editor

H. W. Dickow, Business Manager. Norris Hawkins, Associate Editor.  
D. B. McGown, Technical Editor. Frank C. Jones, Ultra-Short-Wave Engineering Editor.  
Clair Foster, Amateur Activity Editor. George B. Hart, Contributing Editor.

25c per copy, \$3.00 per year by subscription in the U.S. \$4.00 elsewhere. Send subscriptions to the San Francisco office. Entered as second class matter at the Post Office at San Francisco, California, under the Act of March 3rd, 1879.

Vol. 16

JULY, 1934

No. 7

## RADIOTORIAL COMMENT

### The New Electron Multiplier

THE LATEST STEP in putting the electron to work is the development of the so-called electron multiplier by Farnsworth, the wizard of television. This is a filamentless vacuum tube which gives a million-fold distortionless amplification without a transformer. He developed it to increase the sensitivity of his picture pick-up tube, but it is applicable wherever amplifier tubes are now employed. Furthermore it can be made to operate as a self-excited oscillator or to function as a super-sensitive detector. It does all that can be done by the tubes which depend upon a heated filament as the source of free electrons, and does it better.

It depends upon the principle of secondary emissions from two cold electrodes under the impact of electrons initially freed from a photo-sensitive surface. A high frequency voltage bats the electrons back and forth across the space until they are finally drawn out of it by a positively charged strip around the middle of the tube.

Preliminary information from Farnsworth indicates that this tube will revolutionize amateur transmitter practice. It opens up vast new fields for experimentation and bids fair to supersede the filament-type of tubes entirely. Further details will be published in an early issue.

\*\*\*\*\*

### The Profit-Motive and the Amateur

DURING THIS TIME of discussion about the elimination of the profit-motive from business, there is a lack of practical examples of just how well this idealistic theory might work if it were applied as a solution of economic problems. In the absence of any outstanding instance of continued success in cases where men work without opportunity for profit, most men are inclined to think that its elimination would kill progress. Yet there is an outstanding case which affords a basis for comparison in many respects, excepting the all-important economic aspect. This is amateur radio.

The radio amateur works at his hobby because he likes it. He works without thought of monetary compensation. For him, there is no profit-motive. He often becomes more expert than his professional brother and much of the advancement in the science of radio is credited to his initiative and industry. Were subsistence provided, there consequently is no validity in the argument that progress is dependent upon profit.

While there is little likelihood of attaining such an ideal state of society during the present generation, we are already face to face with the problem of beneficial utilization of greater leisure than our forefathers enjoyed. Amateur radio is one answer to the question.

\*\*\*\*\*

### The 5-Meter Motive

SPEAKING OF THE profit-motive, with whose elimination the RCA-NBC part of the RCA-NBC-ARRL project is certainly not concerned, raises the question as to why they are so much interested in getting more amateurs on the 5-meter channels. Surely there is not enough profit in the sale of tubes to justify a thirteen-week chain program dramatizing the achievements of the radio amateur! Where is the nigger in the wood-pile?

Some shrewd observers think that it is a clever scheme to get a hundred thousand listeners on 5 meters. That will provide a ready-made audience for 5-meter broadcasts of pictures and their accompanying sound effects. Thereby would be solved the economic problem of commercializing television, which can be put on the air whenever it can be financed. Not so bad!

Then when the tele-viewers start to complain about amateur interference with picture reception, the amateurs can be ejected as readily as they were from 200 meters. And again would history repeat itself.

Whatever may be the motive, there can be little interest in the 5-meter band for the boy who is interested in long-distance communication. The old saying, "the sky's the limit," is here translated to mean the horizon is the limit, and the horizon for an amateur antenna seldom extends beyond fifty miles.

\*\*\*\*\*

### W. R. G. Baker's Views On Television

SPEAKING before the ninth annual convention of the Institute of Radio Engineers, W. R. G. Baker, vice-president and general manager of RCA Victor Company, outlined the difficulties that must be overcome before there can be a television receiver in the average home. Mr. Baker says the service range per television transmitter will be from 15 to 20 miles radius and in general limiting the locations to those capable of ser-

vicing 100,000 population. This would require about 80 transmitters, with an investment of, roughly, 40 million dollars. The annual maintenance and operating costs would be about 14 million dollars. The time required to set up such a system would be at least six to eight years.

The entertainment life of the television artist will be much shorter than that of the sound entertainer, because the public will soon become tired of looking at the same artist.

\*\*\*\*\*

### Challenge To Industry

"THE question is—who will provide the capital?" asks Mr. Baker. Even if the technical and financial problems are solved, there would still remain the question of what would be transmitted. The public has been educated by motion picture technique to expect high-class entertainment. Unlike radio, television will require undivided attention of the audience, which may mean television programs at only certain times during the day.

Mr. Baker then stated that the problems of television are so complex and the capital required runs into such fantastic figures, that he feels these factors are hopeful rather than pessimistic. They simply indicate that we do not have the necessary tools or information on which to base a national system of television, and they stand as a challenge to the engineers and to the radio industry to discover new tools and new methods in order that television may become commercial.

\*\*\*\*\*

### Amateur Radio Protective Association

THE recently-announced east-coast movement to enlist the services of an independent and select group of prominent and influential radio amateurs from all parts of the U. S. into the newly-formed Amateur Radio Protective Association has met with widespread approval. The purpose of the movement is to protect the interests of the radio amateur from commercial encroachment and to formulate the plans for a method of wider band assignment for amateur use. The movement will be independently financed. More detailed reports from the secretary and counsel are promised for an early issue.



# COL. FOSTER'S COMMENT



## My Reply to a Letter From W4AA

W4AA,  
Dear OM:

Much valuable information in your letter of May 9. But, say, ole feller, you'll have to take ARRL affairs less seriously if you are to get any fun out of amateur radio. The fate of nations doesn't hang on what the Warner-Segal-Maxim combination is doing, you know. Nor does the fate of amateur radio itself. We are in a phase that every non-commercial activity, of whatever variety, encounters when there is money to be made out of it. When there is money in it there invariably are men who use their amateur status to get that money. But in the end the providers of the money, having paid dearly for their experience, are the wiser for it. That is what the amateurs are now getting for theirs and thousands of them are at last seeing the light.

You expect too much of humanity. You yourself are essentially honest and straightforward. Anyone with a knowledge of men can see that at a glance. You think that people generally are like yourself. Well, people generally are NOT. Once get that into your head and you will be saved much disillusionment.

Segal's connection with the highbinders who tried to get control of that broadcasting station without buying it is not so bad. Segal is a lawyer. Unfortunately for a large, and not notably scrupulous, man there are a thousand lawyers ready to show him how to beat the law. For every confessed crook there are a thousand lawyers ready to turn him loose on society if he has the price. This is true because these two classes of malefactors will always pay higher than the honest litigant. And, too, back of every racket you will invariably find a lawyer.

Most of us are acquisitive. Our underlying motives are tintured more or less by the thought of our own interests. Segal is of the ultra-acquisitive type. Nothing wrong from the modern "business" point of view—in his going to your town to aid somebody in pulling a fast one in trying to get control of your broadcasting station. You or I would not undertake to acquire it by any such methods, but that does not mean that Segal was departing from the present-day brand of business ethics. It shows, of course, as you say, that the amateurs may have much to lose in having him as perennial counsel for the American Radio Relay League and in position to aid in bargaining away the rights of all amateurs, but an ARRL member can have no kick on Segal's official visit to your ham gathering unless the ARRL paid some part of his expenses on that occasion. That can easily be disclosed by investigation.

I noticed that your ARRL director in the amateur paper he edits announced this hamfest of May 6 and gave as the star attraction

the expected presence of "the Honorable Paul M. Segal of Washington, D. C." As for the Honorable Paul's talk to the meeting, what does it all amount to! What if he did spend 45 minutes in tearing to pieces the logical suggestions for the betterment of the amateurs that appeared in the May issue of "R/9"? Why wouldn't he? Do you expect any man to agree with any movement that may interfere with his own aims! And were not these suggestions of "R/9's" coming before the annual meeting of the directors of the ARRL a few days hence? And wasn't your own director chairman of your hamfest? And what if Segal did tell you several times of the \$15,000 offer Warner had refused so that he might continue to do and die for old Hartford? That's an old one and it's sheer poppycock. It didn't fool anyone old enough to have cut his eye-teeth. The way to call these magnificent-offer bluffs is to demand, "Show me this offer in writing signed by a responsible officer of the corporation." When business corporations are hunting for \$15,000 men they don't go looking for them among people who have had no business experience except such as they may have gained in one narrow line in the publishing business of the ARRL. Most certainly not when the post is one of managing the highly specialized affairs of broadcasting for profit.

Speaking of the ultra-acquisitive type, Warner is decidedly of that type. In my opinion far more so than the Honorable Paul. Warner was hired as secretary of the ARRL in April, 1919, at \$30 a week, plus a bonus of 25 cents on each yearly dues from members, plus again 25% of the net monthly profits of QST. At that time the members were all licensed amateurs, in accordance with the fundamental purpose of the ARRL—a league of transmitting amateurs. There were subscribers to QST who were not members, including commercial radio people and other non-amateurs. From these subscribers, of course, there were no "yearly dues" on which Warner could levy. At that time the "net monthly profits" of QST were little or nothing. Nevertheless, Warner's extra money above his salary up to November 1 of that year amounted to \$898. Keep in mind that at this time all of the ARRL's assets, including QST, were the property solely of the amateurs. There was no legal way by which any part of the ownership could be transferred to outsiders except by the direct consent of every owner. But the transfer was made, notwithstanding. By the beginning of 1920 Warner had a plan under way for switching things around so that everybody who subscribed to QST should become thereby a "member" of the ARRL and the subscription money of each should become "yearly dues" and thus subject to the yearly levy under the wording of Warner's contract. The little that appeared in print is set forth disarmingly on page 24 of QST for March, 1920.

With this switch the whole foundation of a league of licensed amateurs was destroyed. The very men who had conceived the admirable plan of an association composed solely of licensed amateurs acquiesced in the wrecking of it. The amateurs were forced by the switch to throw in their lot with every commercial who chose to "join" the ARRL. They were forced to unite with the very people against whose power and influence they had banded together for the protection of their own rights. They were forced to convey a part of their ownership of the ARRL's assets to anyone—commercial or otherwise—who chose to send in his subscription to QST. The ARRL then and there ceased to be a league of amateurs and it has grown less and less an amateur organization ever since. A great virtue is made by the present officers and most of the directors of the fact that the ARRL has "made money". That is wholly beside the point. The all-important circumstance that under its present ownership the ARRL could not possibly be an instrument for the advancement of the interests of the amateurs and the protection of their rights.

If the switch was made by order of the directors I have found no record of it. At any rate it was made with their knowledge and permission, and I believe that in a suit the courts would have ordered the plan abandoned and the directors and Warner forced to restore to the treasury all moneys taken by reason of it. Whether such action would now be barred by the statute of limitations I don't know but we'll leave that to be determined by the courts in the light of all the circumstances, past and present.

Now let us see how the switch worked in practice. In Warner's first year his extra money, as I have said, amounted to \$898. Then the switch made subscription money "yearly dues" and the scheme worked so well that Warner took from the treasury in 1920, in addition to his salary, \$3,715. And it worked so well that the next year, 1921, he took out, in addition to his salary, \$5,972. And it worked so well that in the following year, 1922, in addition to his salary, he took out \$10,255. And it worked so well that the next year, 1923, he took out, in addition to his salary, \$10,322. And it worked so well that in the first six months of the next year, 1924, in addition to his salary, he took out \$5,699.

Even at this early date there must have been some of those abhorrent beings known to ARRL officers as "agitators", for a new Warner deal was demanded. But by this time the Board was thoroughly sold on the idea that the huge sums Warner had been pulling out of the treasury were the measure of his capacity as a manager of "amateur affairs". They were not. As a standard they were wholly fictitious. They were a measure of nothing but Warner's ultra-acquisitive-

(Continued on page 37)

# Some Facts About Directional Antennas

By FREDERICK EMMONS TERMAN  
Stanford University

THE VALUE of directional transmitting antennas is that they can be made to radiate most of their power in one direction rather than broadcasting this energy in all possible directions. The result is equivalent to increasing the effective power of the transmitting station by an amount which can be made as much as 100 or more times. From the point of view of amateur transmission a gain of 50 means that 100 watts properly directed would be equivalent to 5 KW on an ordinary half-wave antenna. The disadvantage of the directivity, of course, is that stations in other than the favored direction receive extremely poor signals (i.e., the 100 watt transmitter might be no more effective in an undesired direction than a 5-watt non-directional transmitter).

The first thing to consider about directional antennas is the type and amount of directivity desirable. Experience with commercial directional antennas has shown very definitely that it is possible to have too much directivity, since the waves do not always travel along the same path in reaching the receiver, and that the amount of directivity which can be tolerated is quite different. In general, it is found that the great circle path to the receiver, and that very sharp directivity can be used in the horizontal plane. When it comes to directivity in the vertical plane, however, the situation is somewhat different, as it appears that the best angle above the horizon varies from time to time. Experience indicates that the main beam should be directed at an angle not lower than 10 to 12 degrees and not higher than 25 to 30 degrees, and that the vertical directivity should not be too sharp.

Although many types of directivity antennas have been devised, the present trend is towards a few relatively simple types involving a small number of long wires, rather than a large number of small antennas. The best examples of these are the horizontal V, used by RCA, and the horizontal diamond, developed by the Bell system. Antennas of these types are shown in Figs. 1 and 2. It will be noted that both of these antenna systems involve relatively simple structures which are correspondingly simple to build and easy to tune.

The principal factor controlling the design of the V antenna is the angle between the wires. This is determined by the length of the wire according to the relation shown in Fig. 3, and is relatively critical. The amount of directivity obtainable is greater the longer the wires, and commercial antennas of this type are commonly made about eight wavelengths long. A reasonable directivity can be expected, however, for lengths of two to four wavelengths. A number of feeding systems may be employed, of which perhaps the simplest is to make each wire an odd number of quarter-wavelengths long (as, for example,  $3\frac{1}{4}$ ) and then use a resonant transmission line having a current maximum at the junction of antenna and line. The tuning-up process is then just as simple as any current-fed antenna system. If voltage-feed is desired the wires should be an even number of quarter-wavelengths long (as, for example,  $3\frac{1}{2}$ ).

A single V antenna is bi-directional. The back end radiation can be redirected forward

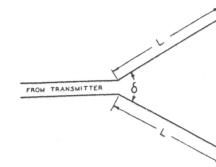

FIG. 1

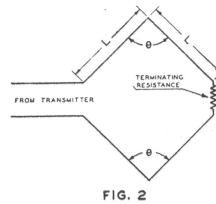

FIG. 2

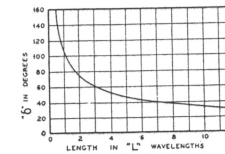

FIG. 3

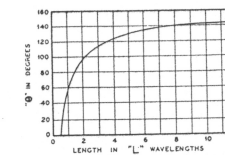

FIG. 4

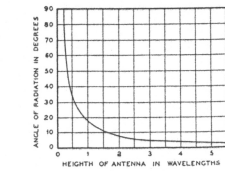

FIG. 5

by a reflecting antenna similar to the radiating antenna but located an odd number of quarter-wavelengths behind and faced so that the two antennas are supplied with current 90° out of phase. The exact details of accomplishing this result are somewhat involved and should not be undertaken unless one has had some experience with problems of this sort.

The diamond antenna operates in a manner considerably different from the usual antenna employed by amateurs. This antenna is non-resonant and possesses a current distribution which dies away uniformly from the input corner to the terminating resistance. As a result of this behavior, the diamond antenna is not critical with respect to frequency and can be used without any change of adjustment over a frequency range of at least 2 to 1. The antenna is, furthermore, unidirectional, since the terminating resistance eliminates the radiation which would otherwise take place in the backward direction. These properties make the diamond antenna desirable from many points of view. It can, for example, be used at 20 meters in the daytime and 40 meters at night without any change. In constructing a diamond antenna the proper thing to keep in mind is the angle  $\theta$  which is related to the length of the legs as shown in Fig. 4. The terminating resistance should then be given the value which eliminates the resonances along the line and will be in the order of 800 ohms.

The antenna also offers a resistance load of about 800 ohms to the transmission line. The vertical directivity of horizontal antennas such as have been described depends primarily upon the height of the antenna above ground rather than upon other characteristics of the antenna. This is because the ground reflects the energy radiated in its direction and this reflected energy combines with the main energy either to reinforce or to cause cancellation, depending upon the vertical angle. The higher the antenna the lower (i.e., the nearer the horizontal) will the reflected energy reinforce the directly radiated energy with the result that the higher the antenna above ground the closer to the horizontal will be the radiation. This is shown in Fig. 5 from which it is seen that if the height is one wavelength then the bulk of energy will be directed at a vertical angle of approximately 16°, while if the height is one-half wavelength, the angle will be 30°. Horizontal antennas should, therefore never be less than  $\frac{1}{2}$  wavelength above the ground if they are to be used for long distance communication.

Amateurs having available the requisite space can use very simple structures such as have been described, to increase greatly the effectiveness with which they can communicate in some general direction, such as, for example: toward the Orient, South America, the Atlantic Coast, etc. The gains that can be realized in this way are obviously worth the trouble, for who would not like to make a 20-watt transmitter sound like 1 KW, or 1 KW sound like 50 KW? Directivity also offers attractive possibilities to those interested in 5-meter work, since at these frequencies, the space required is small. As a consequence, it is possible to obtain enormous directivity in a city back yard, and, furthermore, since these frequencies propagate in straight lines, an accurately aimed beam can be just as sharp as one can make it.

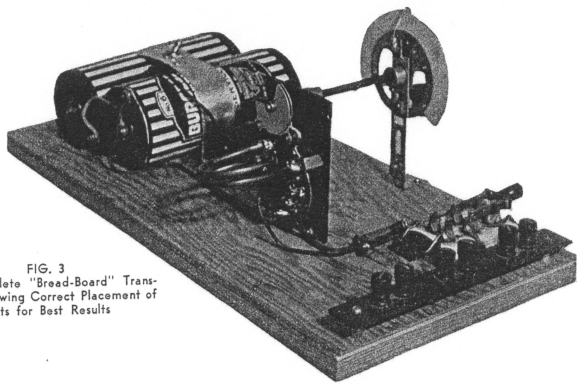

FIG. 3  
The Complete "Bread-Board" Transceiver, Showing Correct Placement of Parts for Best Results

# One-Tube 5-Meter Transceiver

By FRANK C. JONES, Ultra-Short-Wave Editor

## Introduction

THE five meter amateur phone band offers an interesting field for the newcomer and experimenter. This band is not crowded; in fact it is unoccupied in most communities, and yet the necessary equipment is simple to construct and costs far less than that needed for operation in any of other amateur bands.

The five meter signals are useful over relatively short distances . . . usually not over five to ten miles. Greater distances are possible under favorable conditions, and two-way phone communication has been conducted over distances up to 150 miles. The low wavelengths are of such a high frequency that only the direct wave is used, since the Heaviside layer seldom reflects these frequencies back to earth, as is done on longer wavelengths. Herein lies one of the advantages of this band, since no interference is created beyond a range determined by the apparent curvature of the earth and the elevation of the transmitting station. This means that hundreds of communities can make full use of this band without the overcrowding effects and great amount of interference which fills up the other amateur bands.

Another advantage of this band is that very low-power transmitters can be used. This results in a decided saving to one's pocket-book. The receivers are also simple and economical to build. The low-power receiving type tubes can be used for both transmitting and receiving, and a great deal of fun can be had where friends in a neighborhood wish to make tests and talk to each other. Even to an old-time "CW" amateur, there is a thrill in using phone, although the other station may be only a few houses away.

Greater power, such as can be had from type 210 or 800 tubes operated in m.o.p.a. or crystal controlled circuits, has its place and is a future step to those really interested in the amateur game. The complication of such circuits and the peculiarities of adjustments calls for considerable experience. The advantages of such circuits on five meters are freedom from frequency modulation, ability to put the signals into small valleys or behind small hills, and a personal satisfac-

tion of transmitter accomplishment. This field is more for the advanced experimenter, or for ultra-short wave police and television stations.

## Five Meter Circuit Analysis

FIVE meter circuits can be compared with the circuits used in broadcast or short-wave sets. The functions are similar—an antenna is needed to pick up the signals and provide electrical energy which can be detected, amplified, and made audible in a headset or loudspeaker. The transmitter must have some form of oscillator, a method of modulating the carrier signal, an antenna to radiate it and, of course, a microphone to change the voice or sound energy into electrical energy. The functions of capacity, inductance and resistance are exactly the same as in any other longer-wave radio circuit. The difference lies in the size of the inductances and capacities used in the radio frequency circuits. For example, a broadcast receiver coil can be made by winding 30 to 40 feet of wire on coil, tuned by a large variable condenser having 15 to 20 plates. For five meters, a foot of wire or tubing, wound into a coil, is usually ample when tuned by a midget two or three plate condenser. Theo-

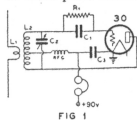

FIG. 1

retically, the vacuum tubes should be smaller for greater efficiency; however some types of commercially available tubes are suitable.

A typical five meter receiver circuit is shown in Fig. 1. The five meter wave cuts through the antenna and induces an electric current in it. This oscillating current induces another into L2 if L1 and L2 are near each other. L2 may be of from one to ten turns, depending upon the diameter of the turns. For example, the set herein described has 2 turns, 2 inches in diameter. The inductance L2 is tuned to resonance by means

of C2 in order to make the receiver responsive to the desired wavelength within the five meter band. The reactance of L2 and C2 are opposite in phase, or cancel each other, leaving only the resistance in the tuned circuit at resonance to limit the value of induced current. Thus a relatively large value of induced current flows through the inductance and around through the tuning condenser C2 and its shunt capacities, due to the wiring and tube. The voltage across either the inductance or capacity depends upon the reactance of that particular element, consequently the actual voltage across the input to the detector tube is increased enormously by resonance. This tube is a voltage operated device; the greater the signal voltage, the greater the audio signal across the telephone receivers.

Since the field intensity at the receiving antenna is in terms of microvolts or millionths of a volt, due to the use of low-powered transmitters and wave attenuation, the receiver must have a great deal of amplification. The most practical way to accomplish this is by means of extreme regeneration, or what is called "super-regeneration". Regeneration consists of feeding part of the signal voltage in the plate circuit back into the grid circuit and thus obtaining an amplifying action. This effect can be continued with increased amplification until the tube breaks into continuous oscillation, which ruins the detection characteristic of the tube. Super-regeneration consists of a means of increasing the tube regeneration until it goes into oscillation, then automatically backing it off into a non-oscillating condition. This action continues at some frequency which is above the audible values in the range of from 15,000 to 200,000 times per second. This super-regeneration amplifies a weak signal many thousand times. This effect is especially applicable to the five meter band, and at present is the most practical method for obtaining the necessary sensitivity to weak signals.

The circuit shown in Fig. 1 is a good oscillator, but proper proportions of R1, C1, C3 and the plate supply voltage allow the super-regenerative effect to take place. R1 and C1 cause a blocking action which throws the

detector in and out of oscillation at a high rate of frequency. R1 can be returned to filament or to +B as shown, depending upon its value, but for less overloading and distortion effect on strong five meter signals the

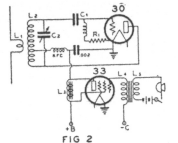

FIG. 2

connection shown is highly desirable. C3 must be large enough to bypass the high super-regenerative surges back to filament, but not large enough to short-circuit the audio frequencies in a modulated signal which must be impressed across the telephone receivers or audio amplifier. Common values for R1 are from 1/4 to 2 megohms, C1 of .00025 mfd. and .006 mfd. for C3.

In Fig. 2 is shown a five meter transmitter such as is used in many present day low-power sets. The microphone causes a variation of current through L5 due to sound waves from one's voice striking the diaphragm, and thus varying the resistance. L5 is coupled closely to L4 by means of an iron core which is permissible because only audio frequencies are being used at this point. L4 and L5 are the two coils of a microphone transformer. Usually the coil L4 has 15 or 20 times as many turns as L5, resulting in that same proportionate increase of voltage and decrease of current. Since no resonance to any particular audio frequency is desired (which would result in distortion, because it would be amplified more than the other audio frequencies), no tuned circuit is used in either the plate or grid circuit of this modulator tube. The modulator tube amplifies the audio voltage across its grid circuit, and applies it across the modulation choke L3 which offers a high reactance to audio frequencies. This voltage adds and subtracts, over its cycle, to the steady DC plate voltage which supplies the oscillator. For example, if there is a 90-volt sine wave AC peak voltage across the choke L3 due to the action of the microphone, this voltage will add to and subtract from the DC supply, which may be 180 volts of B battery. This means that over the audio cycle the actual plate voltage on the oscillator is varying from 90 up to 270 volts, even though it is only 180 volts of B battery is used. The power output of the oscillator varies with the plate voltage and thus a signal of varying amplitude is impressed on the antenna. This variation is in accordance with the microphone input. The carrier signal may be modulated in accordance with one's voice.

The oscillator in Fig. 2 is quite similar to the one shown in Fig. 1 but it uses a lower value of grid leak. The lower value of R1 allows steady oscillation to take place, and energy can be fed to the antenna system through the coupling between L2 and L1. Capacitive coupling can be used instead of inductive coupling with equal results.

**Antennas**  
For either transmitting or receiving, the antenna should be as high above ground as possible. A half-wave antenna coupled directly to the set, either by a very small capacity at the end to the grid or by means of a small coil as shown in Fig. 1, will work satisfactorily but greater distance can be attained by using a high antenna. This usually means some form of RF feeders, such as shown in June "RADIO". Even an ordinary broadcast or short-wave receiving antenna may be used on five meters because of the harmonic effect. Such an antenna was used successfully to talk over a distance of ten to twelve miles be-

tween San Francisco and Oakland, using the small combination transmitter and receiver shown in Fig. 4.

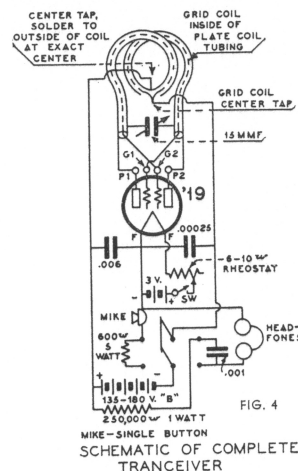

FIG. 4

This is the Circuit for the Transceiver Shown in the Picture (Fig. 3)

## IMPORTANT!

The Transceiver herein described will be on exhibition in the display of Allied Radio Corp. at the Chicago Fair. It will be also made available in kit form by Allied, and sold under the trade name, "KNIGHT". The Knight-Jones Transceiver uses a circuit somewhat different from the one shown above (Fig. 4). The following changes were made for the "KNIGHT":  
(1) The 600 ohm, 5 watt resistor was eliminated.  
(2) A 75,000 ohm fixed resistor and a 500,000 ohm variable resistor were substituted in place of the 250,000 ohm fixed resistor.  
(3) The by-pass condenser across the head-phones was eliminated.  
All other constants remain the same as those shown in Fig. 4.

## Wavelength or Frequency Determination

SOME means of adjustment of the transmitters and receivers must be made in order to operate within the amateur five meter band of from 56 to 60 megacycles. This band is over four times as wide as the whole American broadcast band, yet it covers only a third of a meter in this range. In localities where there is some five meter activity a frequency check can be given by other amateurs who have calibrated frequency meters or receivers. Otherwise one must use a calibrated frequency meter, or wavemeter, in order to be certain of legal operation. Parallel or Lecher wire systems may also be used for measurement to within an accuracy of about 1%.

Parallel wires suitable for this purpose can be strung between two supports from 35 to 40 feet apart. Bare wire, No. 18 to 14 gauge, should be used with a spacing of about three inches between wires. Resonance indication is obtained by coupling the oscillator coil to the closed loop end of the parallel wires, and then sliding a short-circuiting copper link along the wires. An indication can be obtained by means of a millimeter

in the oscillator grid or plate circuit, or more preferably by means of a variation of RF current. This can be done by means of a small turn of wire connected in series with a 6-volt radio dial light or RF thermogalvanometer and coupled to the oscillator coil along with the parallel wire loop. A decided change of current will be had when the shorting link of wire is across some half-wave point on the parallel wires. Sliding this link along between the first and second points of indication, and careful measurement with a scale or tape measure, will give the wavelength of the oscillator. This distance should be between 16.40 and 17.55 feet for oscillation in the amateur band of from 56 to 60 megacycles, which is from 20 or 25 feet of parallel wires. This length can be used and a small variable condenser connected across the loop end, about 3 inches from it, in order to bring the first indication point up to within 2 or 3 feet of the loop end. The second indicated point will still be 16.4 to 17.55 feet from the first for proper operation. A little absorption-type wavemeter can be conveniently calibrated from this set-up and a very accurate check obtained from a harmonic calibration from a known frequency quartz crystal oscillator.

## Combination One Tube Transmitter-Receiver

FOR the newcomer in the five meter band, the set shown in Fig. 4 is about as simple as one can possibly build, consistent with worthwhile results. It puts out a well-modulated, strong signal as a transmitter and functions as a sensitive super-regenerative detector in the receive position.

(Continued on page 29)

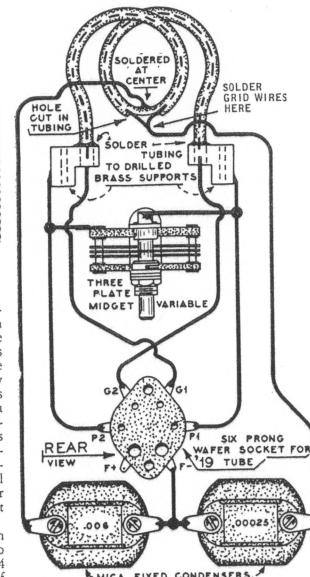

Pictorial of the RF Portion of Fig. 4. The plate coil is a two-turn loop of 3/8-in. diameter copper tubing. The grid coil (push-back insulated wire) is woven into the copper tubing and a center-tap of the grid coil brought out through a hole in the tubing as shown above.

# Transceiver for National Park Service

By CHAS. L. WATSON\*

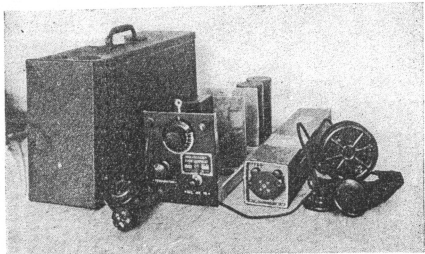

Battery Box, Antenna Reel and Special 144 Volt B Batteries for National Park Transceiver

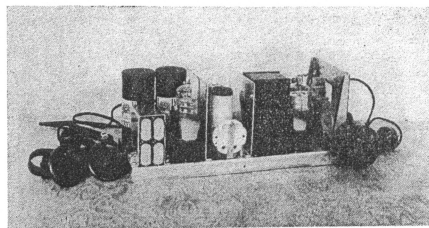

Transceiver—Battery Operated—Crystal Control—Compact, Lightweight

WITH summer here and the urge to get out into the wide open spaces, it is reasonable to presume that the old car may eventually rattle into one of the National Forests. One of the first things that will impress you is the elaborate precautions taken to guard against that destructive demon, fire. Signs—some that tell you to be careful to extinguish all camp fires, are to be found in profusion. Some National Forests do not even permit smoking, and others even insist that a shovel be carried by every car; this is to be used to fight fire, should it occur. With these elaborate precautions, one would imagine that forest fires would be nonexistent. Unfortunately, this is not the case. Fires start, and once started, usually prove extremely difficult to control.

Heretofore, one of the main difficulties in fire fighting has been lack of reliable communication between the base and the actual fighters on the front. A thousand details must be carried out by the base; supplies, an army of men and reliable information as to the progress of the fire are things that must be taken care of. To be sure, telephone lines are run throughout all National Forests but these of necessity must be rather far apart and not immediately accessible to the scene of fire-fighting operations. The further possibility of lines being swept out by fire makes telephone service inadequate. Enter radio.

The Park Service officials were quick to realize the possibilities of portable radio telephone sets in fire fighting, the result being that many of the National Parks are now completely equipped with radio sets of the portable and semi-portable types, in addition to a large transmitter usually located at Ranger Headquarters. The smaller sets are light enough to be carried either on horseback or by hand; the semi-portable sets are intended to be carried by automobile or horseback only.

One type of portable set was designed and constructed by Western Wireless Ltd. of San Francisco to conform with all specifications of the National Park Service. Since this little set is unique, a brief description is in order.

Try to imagine a two-stage, crystal-controlled transmitter, a detector and audio, and a stage of Class B in a box only 18 by 6 by 7! It's all there. The Class B stage switches to either transmitter or receiver, to become, respectively, a modulator or an audio

amplifier. Switching from send to receive is accomplished by a multi-pole switch on the panel; this switch changes the Class B to either position. Since filament current consumption must be kept at a minimum, filamentary type DC tubes are used throughout. A type 34 acts as a screen grid, grid-leak type detector. This feeds into a type 30 as a driver stage for the

tube. The crystal oscillator even insist that a shovel be carried by every car; this is to be used to fight fire, should it occur. With these elaborate precautions, one would imagine that forest fires would be nonexistent. Unfortunately, this is not the case. Fires start, and once started, usually prove extremely difficult to control. Heretofore, one of the main difficulties in fire fighting has been lack of reliable communication between the base and the actual fighters on the front. A thousand details must be carried out by the base; supplies, an army of men and reliable information as to the progress of the fire are things that must be taken care of. To be sure, telephone lines are run throughout all National Forests but these of necessity must be rather far apart and not immediately accessible to the scene of fire-fighting operations. The further possibility of lines being swept out by fire makes telephone service inadequate. Enter radio. The Park Service officials were quick to realize the possibilities of portable radio telephone sets in fire fighting, the result being that many of the National Parks are now completely equipped with radio sets of the portable and semi-portable types, in addition to a large transmitter usually located at Ranger Headquarters. The smaller sets are light enough to be carried either on horseback or by hand; the semi-portable sets are intended to be carried by automobile or horseback only. One type of portable set was designed and constructed by Western Wireless Ltd. of San Francisco to conform with all specifications of the National Park Service. Since this little set is unique, a brief description is in order. Try to imagine a two-stage, crystal-controlled transmitter, a detector and audio, and a stage of Class B in a box only 18 by 6 by 7! It's all there. The Class B stage switches to either transmitter or receiver, to become, respectively, a modulator or an audio

amplifier. Switching from send to receive is accomplished by a multi-pole switch on the panel; this switch changes the Class B to either position. Since filament current consumption must be kept at a minimum, filamentary type DC tubes are used throughout. A type 34 acts as a screen grid, grid-leak type detector. This feeds into a type 30 as a driver stage for the tube. The crystal oscillator even insist that a shovel be carried by every car; this is to be used to fight fire, should it occur. With these elaborate precautions, one would imagine that forest fires would be nonexistent. Unfortunately, this is not the case. Fires start, and once started, usually prove extremely difficult to control. Heretofore, one of the main difficulties in fire fighting has been lack of reliable communication between the base and the actual fighters on the front. A thousand details must be carried out by the base; supplies, an army of men and reliable information as to the progress of the fire are things that must be taken care of. To be sure, telephone lines are run throughout all National Forests but these of necessity must be rather far apart and not immediately accessible to the scene of fire-fighting operations. The further possibility of lines being swept out by fire makes telephone service inadequate. Enter radio. The Park Service officials were quick to realize the possibilities of portable radio telephone sets in fire fighting, the result being that many of the National Parks are now completely equipped with radio sets of the portable and semi-portable types, in addition to a large transmitter usually located at Ranger Headquarters. The smaller sets are light enough to be carried either on horseback or by hand; the semi-portable sets are intended to be carried by automobile or horseback only. One type of portable set was designed and constructed by Western Wireless Ltd. of San Francisco to conform with all specifications of the National Park Service. Since this little set is unique, a brief description is in order. Try to imagine a two-stage, crystal-controlled transmitter, a detector and audio, and a stage of Class B in a box only 18 by 6 by 7! It's all there. The Class B stage switches to either transmitter or receiver, to become, respectively, a modulator or an audio

amplifier. Switching from send to receive is accomplished by a multi-pole switch on the panel; this switch changes the Class B to either position. Since filament current consumption must be kept at a minimum, filamentary type DC tubes are used throughout. A type 34 acts as a screen grid, grid-leak type detector. This feeds into a type 30 as a driver stage for the tube. The crystal oscillator even insist that a shovel be carried by every car; this is to be used to fight fire, should it occur. With these elaborate precautions, one would imagine that forest fires would be nonexistent. Unfortunately, this is not the case. Fires start, and once started, usually prove extremely difficult to control. Heretofore, one of the main difficulties in fire fighting has been lack of reliable communication between the base and the actual fighters on the front. A thousand details must be carried out by the base; supplies, an army of men and reliable information as to the progress of the fire are things that must be taken care of. To be sure, telephone lines are run throughout all National Forests but these of necessity must be rather far apart and not immediately accessible to the scene of fire-fighting operations. The further possibility of lines being swept out by fire makes telephone service inadequate. Enter radio. The Park Service officials were quick to realize the possibilities of portable radio telephone sets in fire fighting, the result being that many of the National Parks are now completely equipped with radio sets of the portable and semi-portable types, in addition to a large transmitter usually located at Ranger Headquarters. The smaller sets are light enough to be carried either on horseback or by hand; the semi-portable sets are intended to be carried by automobile or horseback only. One type of portable set was designed and constructed by Western Wireless Ltd. of San Francisco to conform with all specifications of the National Park Service. Since this little set is unique, a brief description is in order. Try to imagine a two-stage, crystal-controlled transmitter, a detector and audio, and a stage of Class B in a box only 18 by 6 by 7! It's all there. The Class B stage switches to either transmitter or receiver, to become, respectively, a modulator or an audio

amplifier. Switching from send to receive is accomplished by a multi-pole switch on the panel; this switch changes the Class B to either position. Since filament current consumption must be kept at a minimum, filamentary type DC tubes are used throughout. A type 34 acts as a screen grid, grid-leak type detector. This feeds into a type 30 as a driver stage for the tube. The crystal oscillator even insist that a shovel be carried by every car; this is to be used to fight fire, should it occur. With these elaborate precautions, one would imagine that forest fires would be nonexistent. Unfortunately, this is not the case. Fires start, and once started, usually prove extremely difficult to control. Heretofore, one of the main difficulties in fire fighting has been lack of reliable communication between the base and the actual fighters on the front. A thousand details must be carried out by the base; supplies, an army of men and reliable information as to the progress of the fire are things that must be taken care of. To be sure, telephone lines are run throughout all National Forests but these of necessity must be rather far apart and not immediately accessible to the scene of fire-fighting operations. The further possibility of lines being swept out by fire makes telephone service inadequate. Enter radio. The Park Service officials were quick to realize the possibilities of portable radio telephone sets in fire fighting, the result being that many of the National Parks are now completely equipped with radio sets of the portable and semi-portable types, in addition to a large transmitter usually located at Ranger Headquarters. The smaller sets are light enough to be carried either on horseback or by hand; the semi-portable sets are intended to be carried by automobile or horseback only. One type of portable set was designed and constructed by Western Wireless Ltd. of San Francisco to conform with all specifications of the National Park Service. Since this little set is unique, a brief description is in order. Try to imagine a two-stage, crystal-controlled transmitter, a detector and audio, and a stage of Class B in a box only 18 by 6 by 7! It's all there. The Class B stage switches to either transmitter or receiver, to become, respectively, a modulator or an audio

amplifier. Switching from send to receive is accomplished by a multi-pole switch on the panel; this switch changes the Class B to either position. Since filament current consumption must be kept at a minimum, filamentary type DC tubes are used throughout. A type 34 acts as a screen grid, grid-leak type detector. This feeds into a type 30 as a driver stage for the tube. The crystal oscillator even insist that a shovel be carried by every car; this is to be used to fight fire, should it occur. With these elaborate precautions, one would imagine that forest fires would be nonexistent. Unfortunately, this is not the case. Fires start, and once started, usually prove extremely difficult to control. Heretofore, one of the main difficulties in fire fighting has been lack of reliable communication between the base and the actual fighters on the front. A thousand details must be carried out by the base; supplies, an army of men and reliable information as to the progress of the fire are things that must be taken care of. To be sure, telephone lines are run throughout all National Forests but these of necessity must be rather far apart and not immediately accessible to the scene of fire-fighting operations. The further possibility of lines being swept out by fire makes telephone service inadequate. Enter radio. The Park Service officials were quick to realize the possibilities of portable radio telephone sets in fire fighting, the result being that many of the National Parks are now completely equipped with radio sets of the portable and semi-portable types, in addition to a large transmitter usually located at Ranger Headquarters. The smaller sets are light enough to be carried either on horseback or by hand; the semi-portable sets are intended to be carried by automobile or horseback only. One type of portable set was designed and constructed by Western Wireless Ltd. of San Francisco to conform with all specifications of the National Park Service. Since this little set is unique, a brief description is in order. Try to imagine a two-stage, crystal-controlled transmitter, a detector and audio, and a stage of Class B in a box only 18 by 6 by 7! It's all there. The Class B stage switches to either transmitter or receiver, to become, respectively, a modulator or an audio

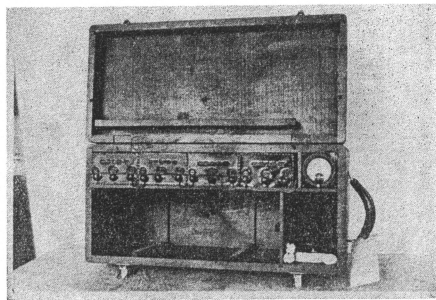

Carrying Case with Battery Compartment and Voltmeter, for Transceiver Illustrated Above

We can assure you from personal experience that it is very gratifying to hear R9 signals from one of these little sets, perched up on the side of a mountain, some eight or ten miles away.

Recently a similar set was used in a daring piece of rescue work in Yosemite National Park, California. A boy, attempting to climb one of the steep, dangerous slopes, worked himself into a position where he could neither go up nor down. His companion was unable to get to him to lend a hand, so at great risk he scaled down the mountain and went for help. In due time a party of rangers arrived, lowered ropes to the stranded boy and raised him to safety. The radio set which they brought along kept them in constant touch with the base and proper medical attention was ready and waiting when the badly-bruised and worn-out boys were brought in. Certainly, radio, our plighting of a few short years ago, has shown its adolescent garb and is taking on the aspects of a potential colossus.

# "I Second Mr. Sargent's Motion, — and Speak In Its Favor"

By ROBERT S. KRUSE\*

GENTLEMEN—It gives me great pleasure to offer evidence in support of Mr. Sargent's remarks on pages 19 and 20 of February "RADIO", as regards the great value of certain antennas for receiving. His advice costs nothing, but is worth more than a shiny new receiver with many black knobs on its vest.

## Inconspicuous

Let us get to the point at once: Is your alleged receiving antenna good enough to send with? Very well—then it isn't good enough to receive with, either. Do you use an ununited sending antenna?

Then why use a crippled receiving antenna?

If in any doubt about the goodness of a sending antenna, try using it for receiving, then try some other sending antenna on the same job. It works the other way, too; if in doubt about a receiving antenna try sending with the thing, and then try the regular sending antenna on the same distant station.

These dead-simple tests produce some rude, but healthy, surprises. In the days before we had amplifiers it wasn't so easy to fool yourself—if the antenna was a dud you heard nothing. That was all. Nowadays you jack up the receiver gain, put up with a lot of racket and manage to drag in a few signals, and a lot of noise. This is in the same class with the broadcast listener that hangs 15 feet of wire inside the room and then damps the noisy reception.

## Measurements

ABOUT a year ago we went to a representative amateur station and checked up our old beliefs—and found them as good as ever. The station was in Connecticut, and like most amateur stations it had a long, narrow yard so that all antennas had to run north and south. Fig. 1 shows the antennas used in the tests.

Reception was from 3 stations. Station A was W2GJ at Oyster Bay, Long Island, using voice, direction south.

Station B was one of the many XDA transmitters using ICW, direction S.W.

Station C was a Canadian commercial which out of courtesy will be credited with C.W. Direction almost north.

The resulting mess of figures has been simplified in the following table which seems to cover average operating needs. The antennas are shown in Fig. 1.

Signal-Over-Noise				
Average for the three frequencies received on.				
	Ant. #1	Ant. #2	Ant. #3	Ant. #4
Station A....	20	7.5	37.5	166
Station B....	5	2	50	50
Station C....	3	1	7.5	16
Average....	9.3	3.5	31.6	77

This table is not in the least concerned with actual signal strength. It is concerned with SIGNAL DIVIDED BY NOISE. What's the good of a strong signal—with strong noise. Better a moderate signal with little noise.

\* Consulting engineer, Guilford, Connecticut.

There are several lessons in this table: 1—Either one of the big antennas is far better than the usual small receiving antenna. 2—The sending antenna of the station is much better for receiving than is the receiving antenna!

3—An antenna such as No. 3 is rather sick when pointed in the wrong direction (compare results on stations A and C) but even so is generally better than a thing like No. 2.

## Antenna Tuning

MR. SARGENT's other point was that tuning the antenna helps signals greatly and does not help the noise.

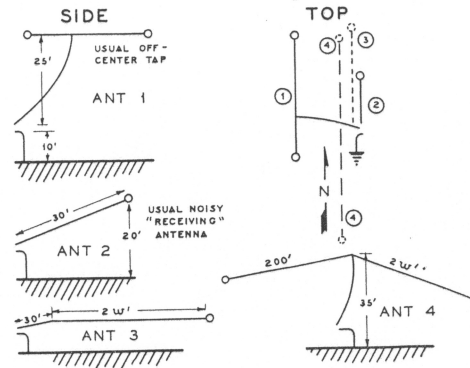

Don Wallace has preached this for years, and for all I know folks in the west are smart enough to use the idea. Here in the east neither stations nor magazines seem to appreciate how this simple old stunt lifts amateur radio reception to an entirely new level without using stenode receivers to push down the noise.

The current belief seems to be that one will have to add another knob and turn it when tuning. Sorta like the man that would have been dog-bitten if there had been a dog and he had been there.

Remember that amateur reception is IN BANDS. It is thoroughly practical to build plug-in or switch-in coils with a series tuning condenser (top end of coil for Marconi antenna coil together tune the antenna to the lets) which is adjusted so that it and the antenna coil together tune the antenna to the center of the band. Then put a "glob" of sealing wax on the thing and leave it alone. Not good enough? Why are you so fussy all of a sudden? Ten minutes ago it was all right to have the antenna tuned clear outside the band, and now it isn't good enough to have it tuned in the middle! You see you are already getting converted to antenna tuning and beginning to take it seriously!

## Tests

PUTTING the talk on the shelf; here are a few comparisons to show what happens when one tunes the antenna.

The mess shown as antenna No. 2 tunes naturally to about 60 meters where you can hear a lot of commercial stations going "blup, blup, blup" by the year without signing. About at right angles to it we have W8KIR, a good amateur fone several hundred miles away. The signal noise ratio on this particular evening is about 4/1, which isn't bad at all. This is with a well-known 5-tube trf receiver. Now we tune up the "antennic", loosen the coupling to the set until we have about the same signal as before—and I can't tell you what the signal/noise ratio is because the noise is GONE. Next we close up the coupling until the noise is about the same as before. Again I can't

tell you what the signal/noise ratio is because the 2nd audio stage is getting blup in the face trying to handle the volume. Choosing an intermediate coupling where we CAN measure things I twiddle the audibility meter and finally satisfy myself that the ratio is about 20/1 now—improved 5 times.

## Weak Signals

MAYBE this proved nothing because we had a good signal to start with. We will try again, using a 7th district fone. With the TRF set used in the ordinary way we can tell he is there, but that's all; the scrapings and gratings of the leaky lightning arrester on the 4600 volt line outside make a mess of his signal. Trying it again with a stenode receiver we can get him in can get the mumbles and grunts that pass for speech when one is using a stenode at full selectivity. Maybe we picked too tough a one—but let's give the tuned antenna a try. Pushing in the tuned-antenna and a resetting the regeneration control a trifle we are somewhat startled to find W7ATC coming through with about 75% intelligibility as determined by word-counting. Neither of the other methods gave over 20% intelligibility, and you can't guess the meaning when 80% of the remarks are missing.

Yes—Mr. Sargent's remarks ought to be listened to.

\* Western Wireless, Ltd.



## Auxiliary Beat Oscillator for G. E. K-80, 80-X & 85

IN RESPONSE to many requests for some means of receiving continuous wave telegraph signals on the new General Electric All-Wave Receivers, Models K-80, K-80-X and K-85, we present this auxiliary oscillator unit.

Continuous wave signals are not ordinarily audible on a short wave receiver. They are exactly like the carrier wave of a broadcasting station during the short silent period between announcements when nothing is being spoken or played into the microphone, except that the wave is broken up into a series of dots and dashes. If these dots and dashes could be made audible, the message which they carry would be intelligible. This is accomplished by combining a locally generated continuous wave signal with the incoming signal in such a way that an audible beat note is produced. The unit herein described furnishes the desired local signal and makes possible the reception of CW signals.

Another valuable use to which this beat oscillator may be put is the location of comparatively weak short wave broadcast stations. A whistle which varies in frequency will be audible as the receiver is tuned across the carrier wave of the station. The receiver tuning may then be adjusted to zero beat and the auxiliary beat oscillator turned off. The desired station will now be perfectly tuned in. A weak station which might ordinarily be missed entirely in tuning across the dial scale will be immediately noticed when using the beat oscillator.

This unit may easily be constructed of parts which are to be found in almost any

amateur's collection. No external batteries of any kind are required and it is not necessary to remove the chassis from the cabinet as all connections are obtained by the use of an adaptor under the intermediate frequency tube.

### Construction

STABILITY is obtained by the use of an electron-coupled oscillator circuit and a high capacity-to-inductance ratio in the tuned circuit. The locally generated signal

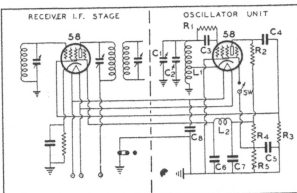

SCHEMATIC CIRCUIT DIAGRAM FOR CONNECTING BEAT OSCILLATOR UNIT TO RECEIVER CHASSIS

### PARTS REQUIRED FOR AUXILIARY BEAT OSCILLATOR

Legend Description	G.E. Part Number
L1—Standard broadcast RF coil with tap for police band	6684
C1—Adjustable capacitor 15 to 70 mmfd.	7062
C2—500 mmfd. fixed capacitor	2276
L2—RF choke or half of any old IF coil	4018
C3, C4—250 mmfd. fixed capacitor	10443
C5, C7, C8—.05 mfd. fixed capacitor	3896
C6—.25 mmfd. fixed capacitor	3597
R1—40,000 ohms, 1/4 watt, fixed resistor	6143
R2—5,000 ohms, 1/4 watt, fixed resistor	2871
R3—125 ohms, 1/4 watt fixed resistor, 250 ohm in parallel	3435
R4, R5—50,000 ohm, 1 watt fixed resistor	2969
SW1—Toggle switch, single pole, single throw	2039
Cable—5-wire cable or twisted wires	
Shield—Coil shield	6688
Shield—Tube shield with base	3789
Shield Cover—Top shield for tube shield	
Socket—2 6-prong bases	6676
Tubes—1 58 tube	

Left—The Auxiliary B.F.O. Installed in the K-80. Below—(Fig. 2) The complete oscillator unit before it is installed in the cabinet.

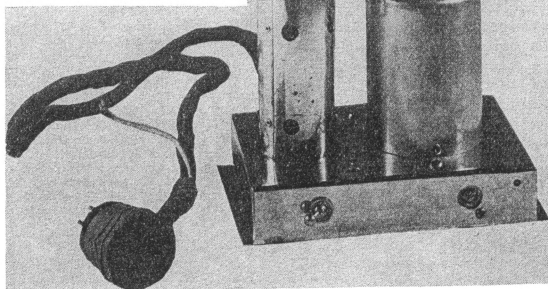

is introduced through the suppressor grid of the intermediate frequency tube. This permits a signal of the correct amplitude to be placed exactly where it is wanted; in the second detector circuit. It also reduces to a negligible value any unwanted signals resulting from the interaction of the heterodyne oscillator in the receiver and the auxiliary oscillator. Although the normal return of the IF tube suppressor grid is to the cathode, no difference in operation results by returning it to ground through a resistor which is the auxiliary beat oscillator plate circuit. The alternating voltage set up in this resistor places a varying potential on the suppressor grid of the IF tube and results in a signal being produced in the second detector circuit which beats any incoming signal to produce an audible note. Adequate choking and bypassing has been employed as a means of keeping the oscillator energy confined to that portion of the circuit where it is required.

Good shielding of the oscillator unit is essential in order to prevent stray pick-up by the exposed grid leads in the set. The unit illustrated was constructed on a 40/1000-ohm chromium-plated steel base which measures 5 1/2 by 4 by 1 1/4 inches, with a 3/8-inch turn-out at the ends for support. Brass is recommended, however, since it is more easily worked and soldered. Both the coil and the tube are well shielded including a top cover on the tube shield.

Fig. 2 shows the placement of parts. The exact arrangement is not critical. All the parts shown are standard General Electric radio parts but equivalent values may be substituted.

The adaptor for placement under the IF tube was made up from an old six-prong tube base and a six-prong socket. The socket used was large but, after trimming the edge, was small enough to permit the tube shield to slip over it. By drilling holes in the side of the tube base in line with each pin and then running fairly heavy leads up from the pin through the hole to the socket terminals a good solid adaptor was obtained. The whole adaptor was then wrapped with rubber tape for additional support and for in-

(Continued on page 32)

## Versatile Miniature Relay-Rack Receiver

"The Gainer" Circuit and New 6C6-76 Tubes Are Used

By CLINTON OSBORNE

THE HOME-BUILT receiver graduates from its "junk shop" appearance with the announcement that the new-type illuminated airplane tuning dials are now available from radio stores. The low-priced, black-crackled steel cans for housing the receiver also add greatly to the beauty of the completed job, not to mention the many other advantages which are gained from enclosing the receiver in a completely shielded metal case.

The newly-announced 6C6, 6D6 and 76 tubes, with filaments that operate from 6 to 6.3 volts AC or battery current, enable the set builder to construct a receiver which can either be powered from the 6.3 volt windings of a power transformer or from a 6-volt storage battery. Furthermore, these new tubes can be operated from dry cells, if one is not too particular as to how long the batteries will last. The 6C6, 6D6 and 76 tubes draw but 0.3 amp. filament current, and a receiver using two of these tubes could well be operated from dry cells. The batteries should hold up for a month, if the receiver is not used on an average of more than an hour and a half a day.

Another feature of the new tubes is their low hum level. With a properly constructed power unit, a receiver using these tubes will have a hum level of very low content. . . in fact, one cannot hear the hum at all, if the receiver is enclosed in a metal shield can. Putting the power unit into a receiver cabinet, when the receiver is of the regenerative type, will sometimes cause a slight hum to be present. However, the hum is not heard when the received goes into regeneration. "Graveyard solitude" prevails.

Several illustrations here show a receiver using the new tubes. One model, of the miniature relay-rack type, has an additional audio stage in which the type 42 tube is used. The 42 is the 6-volt companion of the 2A5. A Magnavox five-inch dynamic speaker is on the upper panel of the rack; the receiver proper is on the bottom panel.

The dials are the new Crowe illuminated airplane type, with glass lens. These dials are vernier driven; one type has a gear reduction and another uses the common wedge drive. The pilot lights can be dipped in coloring dyes and the color of the illumination

can be selected to suit the taste of the individual builder. Or the usual plain-color pilot lights can be used and the effect of the illumination is very pleasing to the eye.

One of the smaller illustrations shows a receiver housed in a black-crackle steel can with hinged top. Another can of the same

56. Obviously the same circuit can be used for 2 1/2 volt filament operation by the mere substitution of a 2 1/2-volt filament transformer, a 57 tube for the detector, and a 56 for the audio. The 58 (or the new 6D6) can be used in place of the 57 (or 6C6) and will give the same satisfaction. The circuit is admirably adapted for short-wave use; it is

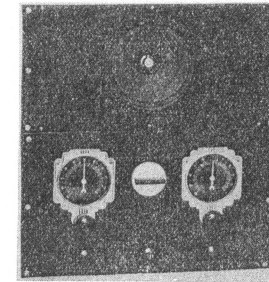

Front View of Relay Rack "Gainer" Receiver

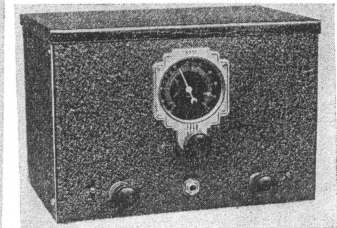

"The Gainer" in a New Dress, Completely Shielded in a Metal Cabinet. Illuminated Crowe Air-plane Tuning Dial Adds Beauty to the Job

size and type is used to house the power unit. These cans are now available from manufacturers and cost less than two dollars each.

The circuit diagram shows the complete hook-up for a receiver using the new 6C6 as a detector and a 76 for the audio stage. The 6C6 is the 6.3-volt companion of the 57, and the 76 is the 6.3 volt companion of the

tried-and-proven one used in "THE GAINER" receivers which were described in this magazine some months ago.

Somewhat more volume was secured when the new 6C6 and 76 tubes were substituted for the 57 and 56. In fact, the volume from local signals is so loud that the volume control had to be turned almost off in order to enjoy comfortable earphone reception.

(Continued on page 33)

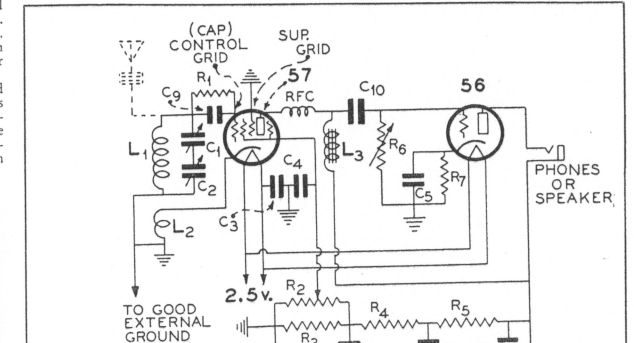

THE CIRCUIT FOR "THE GAINER" ALTHOUGH the circuit shows the use of a 57 tube as detector and a 76 for the audio stage, it is merely necessary to substitute the new 6C6 for the 57, and the new 76 for the 56. Furthermore, the filament voltage must be changed to 6 or 6.3 volts, when using the 6C6 and 76 tubes.

LEGEND  
C1, C2—.0001 mfd. Hammarlund midjet variables. C3—.01 mfd. C4—.5 mfd. C5—.1 mfd. C6, C7, C8—each .5 mfd. C9—.0001 or .00025 mfd. C10—.02 mfd. R1—2 megohms. R2—50,000 ohm Centralab potentiometer. R3, R4—10,000 ohm, 5 watt. R5—5,000 ohm, 5 watt. R6—500,000 ohm Electralab potentiometer. R7—2,000 ohm, 2 watt. L1, L2—Secondary and regeneration coils. See December "RADIO" for coil winding data. L3—20 henry iron-core choke. (250,000 ohm resistor can be used in place of L3.) \*C10 can be reduced to .00025 or smaller if hum cannot be entirely eliminated with larger condenser.

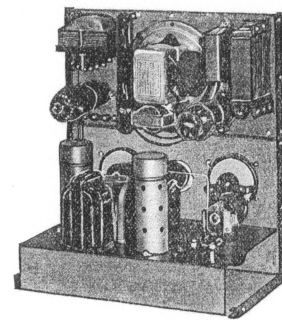

Rear View of "Gainer" Showing 2A5 Power Output Stage and Power Unit at Top of Rack

# The Much-Maligned Linear Amplifier

By W. W. SMITH, W6BCX

**E**VEN BEFORE the advent of Class B audio modulation, the wisecracks tried to discourage the use of linear RF amplifiers, saying that plate modulation of the final was the more economical. Then, when Class B came into general use and the component parts became generally available, and audio warts were cheaper to obtain, there just "wasn't any excuse" for using linears at all. But the fact that broadcast stations always have used linears, the big majority of them still using low level modulation, caused the writer to wonder a bit, instead of accepting the "uneconomical" angle as having foundation. The results of some experimentation along that line were startling: It was found that more 100 per cent modulated carrier watts per dollar could actually be obtained WITH LOW LEVEL MODULATION THAN WITH CLASS B MODULATION OF THE FINAL. As most hams are trying to build the most rig they can for a given amount of money, rather than a given rig for the least amount of money, that means that the money saved can be used to buy a better mike and "high fidelity" audio components for the speech amplifier and low powered modulator.

Before going further, a statement of terminology should be made to avoid confusion. We have come to use the term "grid modulation" when referring to a grid bias modulated stage. But it is obvious that a Class B linear stage is also being grid modulated, though by different means. The final effect is the same, both systems operating by having the excitation on the tube modulated. However, their operation and adjustment is quite different. For that reason it might be well to refer to grid EXCITATION modulated stages and grid BIAS modulated stages. The latter system of modulation, where the excitation is modulated INDIRECTLY by modulating the bias voltage instead of the excitation voltage across the grid coil as is done to a linear stage, is becoming very popular. Grid bias modulation is probably the most economical of all when adjusted for "high efficiency" rather than "high fidelity." The quality of a properly adjusted grid-bias-modulated phone is very acceptable; better, in fact, than some plate-modulated rigs using either poor or mismatched Class B equipment. But real broadcast quality cannot be obtained without sacrificing considerable efficiency. It is a question of whether one wants to tolerate harmonic distortion for the sake of power in the antenna. It is possible to avoid carrier shift with high efficiency, grid-bias-modulation, but the harmonic distortion at high levels of modulation is considerably higher than with either pentode audio or well-designed Class B audio, though it may be cut down somewhat by using the Hawkins "B-Prime" system of bias modulation.

By using a push pull Class A or A-Prime audio modulator to modulate a low powered stage and building up the RF with a correctly designed and operated Class B linear, the transmitted signals will have less harmonic distortion THAN 90 PER CENT OF THE BETTER BROADCAST RECEIVERS (provided the speech system of the transmitter is very good.) And as for modulated watts per dollar, the system compares favorably with high-efficiency grid-bias-modulation.

**T**HE FIRST THING to do in debunking the Class B linear is to disregard the common fallacy that the maximum obtainable carrier is "one-fourth the tube

capacity." That may hold true when the Class C plate voltage rating is used and the bend in the characteristic curve limits the output rather than the tube's plate dissipation. But why run the tube at the plate voltage used with plate modulation? A pair of 211's can be run at 2500 volts with a little care (W6KA has 2650 on his) when used as Class B linears, and 2000 volts is "duck soup" for them. With the higher plate voltage, the bend in the curve is moved way out and extremely tight coupling to the antenna is no longer necessary to keep from "Work-

proaches 40 per cent. So here is what we have: Input, 500 watts; output (at 40% efficiency), 200 WATTS CARRIER; plate dissipation, 300 watts. Some may shake their heads at the last figure, but 150 watts per tube is not detrimental to the new graphite anode 211's, and under modulation the dissipation will decrease anyhow. So the tubes are actually only dissipating about 135 watts apiece except when not talking. It is very important when taking liberties with the plate dissipation rating put on a tube by the manufacturer to make sure there is free circulation of air around the tube.

We need only one high voltage power supply, and it need not be well-regulated. We do not need a flock of large tubes. And we have 250 watts of carrier.

**T**HERE IS NO NEED for using more than one linear stage for amateur work, as a low-powered, inexpensive modulator and Class C stage will successfully drive a linear using a full kilowatt input. A pair of 250's in A Prime modulating a pair of 210's

in push pull will provide more than sufficient well-regulated excitation to drive a 1 KW linear, while for the 211 stage described, a pair of 45's in A Prime modulating a 45 in Class C will do the trick nicely. See Fig. 1. The 45 modulators and the 45 class C tube can be run from a single power supply (good regulation) delivering about 350 or 375 volts. The Class C 45 should run at about 40 mls, and the bias on the modu-

lators (preferably fixed) be adjusted so that the two modulators together pull about 40 mls. They can be biased higher, but there will be more violent swings in the plate current with modulation, making the use of the same power supply for the Class C stage undesirable.

The economy of Class B linears does not hold good only for medium and high power. A rig using four 45's in push-pull parallel in the final, run as a linear stage at 600 volts, will put out as much carrier as a pair of 46's modulated by a pair of 46's in Class B and does not cost as much. See Fig. 3.

For reasons of stability (isolation) and efficiency (impedance match), link coupling should be used between the modulated stage and the linear amplifier, and the low powered stages should either be isolated from, or removed from, the linear stage. A split-transformer (Continued on page 29)

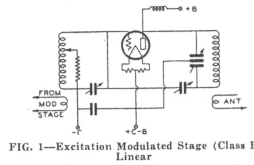

FIG. 1—Excitation Modulated Stage (Class B Linear)

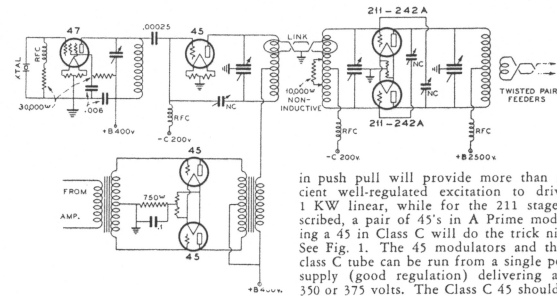

FIG. 2—250-Watt Carrier with Linear Amplifier

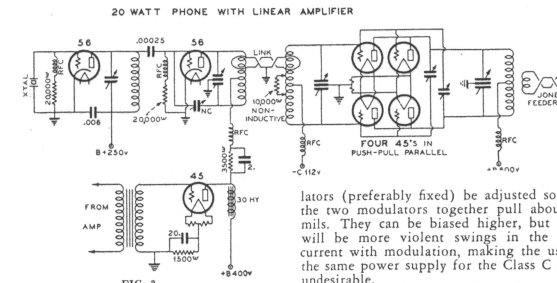

FIG. 3

into the bend." At the high plate voltage the output is limited only by the allowable plate dissipation. By the old method of rating, a pair of 211's (100 watt tubes) would give a 50 watt carrier when run as linears. But when high voltage is used and the plate dissipation is the limiting factor, the output depends upon the rating of the tube and the efficiency of the amplifier. The higher the efficiency, the greater output can be obtained from a tube of given plate dissipation. It was found that the efficiency of a Class B linear amplifier run as described ap-

# 60 Watts of Audio Power From Class-B 10's

By NORRIS HAWKINS

**C**LASS B AUDIO amplifiers are not particularly new, but it is entirely fitting to describe some of the latest refinements which enable somewhat more power to be realized from small tubes. This increase in power output is accompanied by a material improvement in audio quality.

Certain precautions must be kept in mind for high quality Class B results, and it will not be amiss to outline them briefly.

(1) The driver stage must be able to supply about two or three times the actual power required to drive the grids of the Class B stage. This reserve of power is necessary in order that the driving voltage shall have good regulation under the variations in load represented by the Class B grids. In general, the driver output should be from 5 per cent to 15 per cent of the output of the Class B stage itself.

(2) The Class B input transformer should have sufficient step-down so that the driver load impedance never goes below the plate resistance of the driver tube, when the Class B grids are most positive. It follows that less step-down is necessary when using Class B tubes with a high grid impedance. By the same token, the choice of a driver tube with a low plate impedance, such as the 45, 50, 2A3, 2B6 and 42 triode, is necessary for minimum step-down ratios.

(3) The load impedance into which the

prevent the maximum grid voltage from exceeding the minimum plate voltage, at the peaks of grid drive.

(4) The two halves of the circuit must be accurately matched. Because each Class B tube works for only half the cycle, it is essential that they receive exactly the same driving voltage and that they each draw the same plate current in the resting condition. No two tubes will maintain their characteristics for any length of time and it is essential that individual bias adjustments be provided so that the stage can be balanced. This precaution is only applicable with other than the zero-bias tubes, which include the 46, 59, 19, 49, 89, 53, 79, NCB and HK357.

(5) The plate power supply must have good voltage regulation because the plate current varies quite widely with the grid drive. Any variation in plate voltage with changes in plate current will cause amplitude (harmonic) distortion, and is to be avoided. Low resistance windings on the power transformer and filter chokes are essential. The use of a saturated, or swinging input choke helps to keep the output voltage constant with variations in current, because this type of choke provides choke input with a small load and condenser input as the load increases. Thus the output voltage tends to rise slightly as the load increases. This offsets the drop due to the unavoidable resistance in the transformer and choke windings.

The output transformer has a multiplicity of taps, which provides a highly desirable degree of flexibility for those who wish to experiment with various loads.

The power supply uses a special transformer which provides 1300 volts CT for the plates, and 150 volts CT for the bias rectifiers as well as various filament voltages. The 6.3 volts at 1.4 amps, required for the 42 drivers can be obtained from the 7.5-volt filament winding by the addition of a small series resistance of less than one ohm. The 42's are not particularly critical as to heater voltage; any value between 5.5 and 7 volts is satisfactory.

The input choke, CH2, is of the saturated, or swinging variety and aids the voltage regulation. Choke CH1 is a resonant smoothing choke and is much more effective in smoothing ripple than ordinary non-resonant chokes. The smaller portion of the choke, plus the 1 ufd. condenser, are series-resonant to 120 cycles, which provides an extremely low impedance path to ground for the AC component of the rectified voltage. The 20,000-ohm, 200-watt bleeder holds the power supply down under low load and also aids the voltage regulation by increasing the resting load on the power supply.

The bias supply is subject to even wider variations in current than the plate supply and great precautions are taken to make the output of 66 volts entirely independent of grid current. Two 82's are used in the conventional full wave circuit, although at first glance the tubes seem to be in parallel, due to the fact that all four plates are tied together. Note, however, that the filaments are separate.

This procedure is necessary in order to use the same winding for plate and bias supplies. However, if separate windings are available a single 83 could be used in place of the two 82's as bias supply. The filter choke for the bias supply is identical to the resonant smoothing choke used in the plate supply and with the 17 ufd's of filter condenser, removes practically all of the AC ripple from the bias supply. The 240-ohm bleeder in the bias supply is most important. It loads the supply and prevents any change in voltage with variations in grid current.

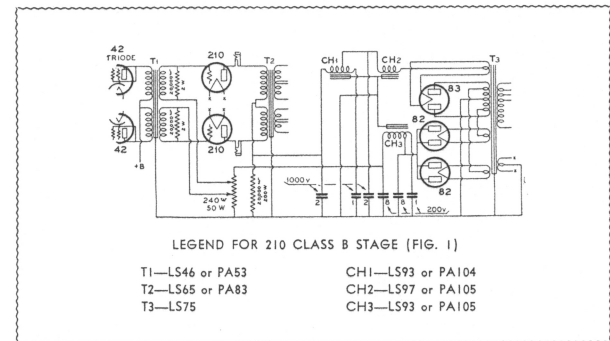

LEGEND FOR 210 CLASS B STAGE (FIG. 1)

- T1—LS46 or PA53
- T2—LS65 or PA83
- T3—LS75
- CH1—LS93 or PA104
- CH2—LS97 or PA105
- CH3—LS93 or PA105

Class B stage works must be fairly high in comparison with the plate impedance of the Class B tubes. The actual value of load impedance is not especially critical, and for practically all common tubes it can be between 8,000 and 20,000 ohms. It is well to keep in mind just what happens when the plate load impedance of a Class B stage is varied. As long as the load impedance exceeds the static plate resistance of the tube, an increase in load impedance improves the quality by reducing the harmonic distortion. It also reduces the power output, for a given grid excitation. Therefore more excitation is required for the same power output, with higher loads. The plate efficiency also increases as the load impedance is increased, so that more output can be obtained, for a fixed plate loss, by merely increasing the grid drive. However, as the load impedance and the grid drive is increased, it is necessary to raise the plate voltage in order to

Mercury vapor rectifiers have an inherent voltage drop that is independent, to a great extent, of the load current, and thus cause no sacrifice of regulation, as is the case with thermionic rectifiers.

(6) With certain tubes, notably some makes of 210's, 203A's, 211's 800's, 204A's and 849's, it is essential to take precautions against super-regenerative dynatron distortion. That imposing mouthful simply means that the stage starts to oscillate on the peaks with a rasping effect which absolutely wrecks the quality. This tendency toward oscillation is caused by a Dynatron kink in the grid characteristics of the tube and can only be swamped-out by the use of 50-ohm parasitic resistors in each grid lead, combined with 5000 to 20,000 ohms shunted across each half of the input transformer secondary. Sometimes it even becomes necessary to shunt each side of the primary of the output transformer with a .001 ufd. condenser.

# "Linear's" Own Phone

## 100 Watts of Carrier-Class B Modulated

By HENRY WILLIAMS

USUALLY when we look behind the scenes in the shacks of those who spend most of their time on research, we find a mass of junk entirely surrounded by haywire. We generally find that nothing works at the moment, but great things can be expected in the future. It is with a good deal of surprise, therefore, that we find a complete and finished transmitter on the operating table as confirmed a "Teaser-Downer" and "Builder-Upper", as OM "LINEAR". The watchword of most writers for technical publications seems to be "Do as I say, but not as

direction bears the scars of forgotten antennas. The main standby at present is an end-fed Hertz, 240 feet long and about 55 feet high.

The candid camera just missed a good shot of the OM himself. He struck a new idea at just that moment, and we couldn't fire-up the camera before he went into retirement to try it out.

We meant to ask him numerous personal questions about himself and why he chose to call himself "Linear", but he escaped before we had a chance. Since he stopped worrying about QSL cards some years ago, the only thing we find on the wall is a faded station license dated 1919.

Well, if we can't talk about Linear, at least we can describe his transmitter.

### The RF Portion

TAKING up the radio frequency portion first, (see Fig. 3) we find fairly-close adherence to convention. When asked about the .006 ufd. condenser in series with the crystal, he merely mumbled something about the advantages of a capacitive reactance at that point, for better oscillator stability. The 841 doubler stage is also standard practice, except for the variable grid leak. When asked why, he rather apologetically mentioned that efficient doubling or tripling depends, to a great extent, on the angle  $\phi$ , through which plate current flows, and that the magic angle  $\phi$  is greatly dependent on the bias.

The next point that strikes the eye is the somewhat unusual-looking neutralizing scheme for the final. It was explained that this eliminates tapped coils and split-stator condensers, and can easily be applied to any conventional doubler stage. He also mentioned that it was rather "pesky" to adjust, using his own phrase, but that long years of practice had enabled him to get it on the nose in his sleep.

We then asked him why the two 841's in the final were in parallel, rather than in push-pull, keeping in mind that this rig goes down on ten meters when the wind is just right. He answered a little abruptly that the mutual conductance of an 841 is low enough to start with, without cutting it in half through the use of push-pull. He also reminded us that neutralizing is much simpler in a single-ended stage. He added that the angel Gabriel himself would have a devil of a time PERFECTLY neutralizing a series-fed push-pull amplifier. We missed out on most of the rest of his ideas on neutralizing a push-pull amplifier, because a battery charger blew up at just that moment. While trying to find his diagonal cutters with one hand and the power

leads to the charger with the other, he managed to shout something about "Howell can you maintain 180 degrees of phase shift without compensating for the capacitive reactance of the neutralizing condensers. One is bad enough, but two that don't know whether they are Hazeltine or Rice functions?"

We then asked the reason for the jack, J2, when he already had a plate milliammeter in the circuit. As the fire was under control by this time, he carefully explained that neutralization of an RF amplifier is greatly simplified

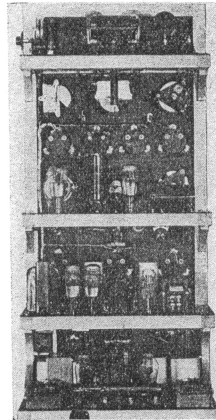

FIG. 2—Rear View of "Linear's" Transmitter. From Top to Bottom: (1) Final Amplifier, Monitor and Collins Coupler. (2) Oscillator and Buffer. (3) Speech and Modulators. (4) Power Supply Units

if the plate voltage is removed from the stage during the process. In Fig. 1 the reader can see the unused phone jack that he uses to open the plate circuit when neutralizing.

### The Audio Channel

TURNING to the audio channel, the circuit of which is shown in Fig. 4, and in the photo, Fig. 5, the first thing that meets the eye is the extent to which decoupling is carried, in order to prevent regeneration and the loss of the low audio frequencies. When asked why he uses no cathode by-pass condensers on the two 57 triode stages, he asked, "What business has any audio got down there in the grounds and power supply leads?" He then explained that if you properly complete your grid and plate circuits back to the cathode ABOVE the bias resistor, you can avoid a great deal of trouble. However, if decoupling resistors are not used in both grid and plate leads, then a cathode by-pass becomes necessary to get any real gain, without troublesome feedback.

The next feature that struck our eyes was the use of the 57 as a triode, instead of its usual pentode function. Linear's eye gleamed

as he smelled a possible argument. Whipping his trusty copy of "Terman" from among the blocks of wood on the drill press, he quickly opened it to the section on resistance-coupled amplifiers. Seeing that he had the drop on us, we surrendered without a fight. Nor to be done out of his prey, he quoted some figures on the effect of shunt capacities on fidelity, when using high load resistances. Then quickly skipping to the part that explains the necessity of a high load resistance for maximum gain, he ran through the gain formula. The next thing we remember was when he snapped the book shut with the crack of a pistol shot and roared, "Now let us consider the Linearity of a pentode, for a moment." Realizing we were cornered, we mustered our flagging courage and countered with, "Well, if you want to talk about LINEARITY let's talk about the four 59's in class B". Ah, it was a telling blow. He visibly winced and his eyes grew sad. "Of course", he said, "it is possible that there is something in what you say, but, perhaps . . . someday . . . (and a far-away look came into his eyes) . . . someday, by the grace of God and the aid of a long spoon, I may find four 59's that actually match . . ." Looking around abruptly, he changed the subject by calling our attention to the power supply circuit (Fig. 6).

### The Power Supply

HE quickly pointed out the .01 ufd. condensers to keep the RF from the transmitter out of the power lines, and explained the bias rectifier and filter which supplied minus 85 volts for the 2A3's. He also pointed out the relay that cuts off the 400 volt plate supply if something should happen to the bias supply. (The words "Western Electric" on the relay were no surprise.) We were properly awed by the 1000 volt voltmeter until Linear explained that the meter cost \$3.00, second-hand, and the 1000 volt scale cost ninety cents additional. The 40,000 ohm combination bleeder and multiplier is a group of Resistica resistance cards of the vintage of 1922. Concealing our embarrassment as best we could, we asked about the function of the lonely blue tube, and an associated tank circuit, which we saw in one corner of the top, or final amplifier shelf.

### The Monitor

THIS, we were told, is a phone monitor that does everything but speak. (See Fig. 7). It indicates the volume level on a db scale. It also indicates approximate percentage of modulation, and it indicates both positive and negative carrier shift. Over-modulation is made evident at once. The Wunderlich detector tube has practically no RF in the plate circuit, which often causes regenerative errors, when the conventional 56

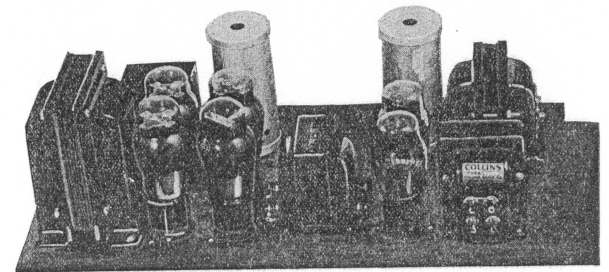

FIG. 5—The Audio Channel. 60 Watts of Audio Power and a Gain of 75 db.

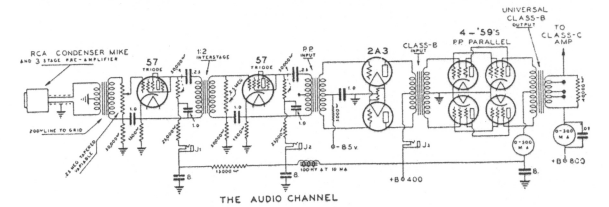

FIG. 4—Circuit Diagram of Upper Illustration. The Single-Ended Stages are Shunt-Feed. Note Absence of Cathode By-Pass Condensers

is used as a linear detector for modulation checks.

Under operation, the transmitter delivers 100 honest watts at the output of the Collins PI network, as measured with carbon lamps. It can be modulated 90% with a 400 cycle tone without plate color or meter wiggle. Between 90 and 100% modulation, the distortion starts to climb, but not unduly.

On the whole, the transmitter will stand copying, as everything in it has stood the test of time. If "Linear" has left it alone for such a long time, it must have that certain something.

P.S.—(Three days later). We have just received word that OM "Linear" is human, after all. He has taken the rig apart and is building a new one. Well, such is life!

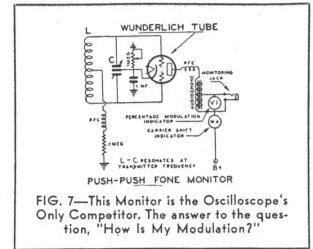
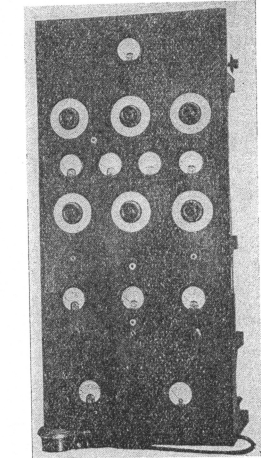

FIG. 7—This Monitor is the Oscilloscope's Only Competitor. The answer to the question, "How Is My Modulation?"



"Linear's" Ton Meter Transmitter (Count 'em)

I do"; I seem to have found the exception that proves the rule.

I would not have the reader think that "Linear's" whole shack is as free from haywire as is his transmitter or his "Banehawk" receiver; because the rest of the place is a mass of discarded breadboards, miscellaneous power supplies, and other junk, and over 100 assorted tubes, soft and otherwise.

His shack is easily identified by passer-by; every tree and ridgepole for 500 feet in any

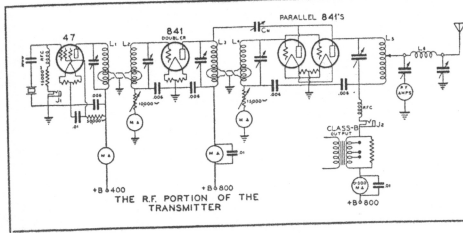

FIG. 3  
120 Watts Input;  
100 Watts Output.  
Note the unusual  
neutralizing circuit  
in the final amplifier.  
It eliminates  
split-stator  
condensers or tapped  
coils

## DX News — By W6WB

WE are pleased to announce that the first member of our DX Country Committee has been selected. Frank Lucas, W8CRA, is the lead-off man. CRA is so well known in DX circles as to need no further introduction. Funny thing, though, we heard him tell W6BIP that when he had worked 100 countries he was going to give up radio. Huh! He now has 107 and is still going strong!

With the 40 meter band showing little DX of interest, practically all of this month's news concerns 20 meters.

### FLASH!

We learn authoritatively that W6FYT and W6VQ were heard on 10 meters by ON4AU! We do not know whether or not they were on ten or whether their harmonics were getting across. At any rate, this is certainly good work. Activity apparently has picked up on this band and east coast stations are

working the middle west daily. Let's get down on 10 and see what's what.

W6CXW has really come into his own. He has a corner on European DX, as you know. He has worked over 120 European QSO's this year with about 60 different stations. Incidentally, Sam, the other half of CXW, is now back from his Japanese trip.

Oh, that mysterious VU2CP! We received a flash from W1HE that he, W1ZL and W1LZ worked VU2CP, which is DX in any language. But—there is a decided difference of opinion in the east as to the authenticity of this DX station. W8CRA was under the impression that he is a "Phony". W3BBB bears this out, saying that he was R6 and so loud as to be almost too good to be true. Now, as to evidence on the other side of the fence, W3JAH who knows his DX and who also worked VU2CP, has another story. He claims he heard this station working VK and ZL stations which would seem to lend credence to

(Continued on page 17)



# A Complete 800 Transmitter

## Employing Sectional Construction

By I. A. MITCHELL  
Chief Engineer, United Transformer Corp.

THE writer's article in the April issue of "RADIO" which covered the design of Class B amplifier systems, working backward from the output tubes to the input tubes, elicited considerable interest. This method of design was used through both audio frequency and radio frequency circuits in the transmitter described below.

The transmitter illustrated in Figures 1 and 2 was planned and constructed by B. J. Fuld, head of the Hudson Division, ARRL (W2BEG) and M. Joffe (W2BNY), both of New York City. The finished transmitter was used as the official transmitter at the recent Hudson Division ARRL Convention in New York City.

Insofar as the electrical design of this unit is concerned, the details are more or less standard. The audio system was divided into a pre-amplifier consisting of 77's triode connected and transformer coupled, and the main amplifier consisting of 2A3's driving the 800's. Inasmuch as frequency discrimination generally enters more rapidly in the low level transformers, high quality transformers housed in hyperm alloy cases were used for the pre-amplifier. These transformers employing alloy cores and being shielded in alloy cases have a very low frequency discrimination and also low pickup as far as induced hum is concerned.

The output of the pre-amplifier is transformer coupled to the 2A3's, which is in turn transformer coupled through a stepdown transformer to the Class B 800's. As has been emphasized many times by the writer, distortion is always present in a Class B amplifier, but proper design can maintain this distortion at a low level. One of the most important factors contributing to harmonic distortion is the fact that the grid current of Class B tubes is far from linear. This means that the driver is working into a non-inductive load whose value varies through a wide change in resistance. Those who are familiar with the 2A3 tube know that the tube is somewhat critical to plate load. It is therefore apparent that a tendency for distortion is effected. By loading the Class B grids with a stabilizing resistance, the change in grid impedance can be made a small part of the total impedance into which the driver tubes look. By choosing an optimum value for this resistance, low distortion can be obtained without too great a loss in power. Regulation of the bias supply is also an important factor in the bias supply. In the transmitter shown, bias was obtained through a separate rectifier system having extremely good regulation. A full 110 watts was obtained out of the audio amplifier with the ribbon microphone shown in the photograph.

When confronted with the problem of building an outfit, the average amateur starts to design his outfit with the oscillator and progresses to the final stage. While this procedure is not entirely erroneous, the method outlined by the writer for the design of Class B systems from the output stage backwards, is more logical. For example, in this transmitter, we have as the final RF stage, a pair of 800's. Since an 800 takes four watts to drive it, two tubes in push-pull require eight watts. Allowing a reasonable margin of safety factor, we choose a type 841 tube to

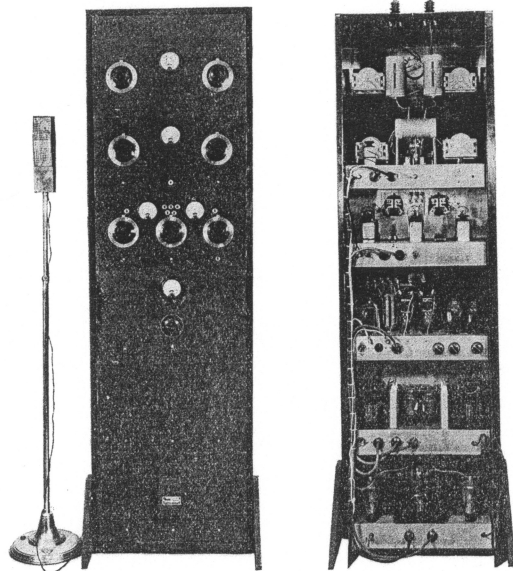

FIGS. 1 and 2—Front and Rear Views of 800 Transmitter

drive them. This leaves a margin of six watts to take care of any losses. It takes only 1 1/4 watts to drive the 841. In order to play safe, another 841 was used here because it operates like a 46 in RF circuits; that is, with no excitation, the plate current drops to a very low level making it possible to obtain bias through the use of a grid leak instead of batteries or cathode bias. The 841 is operated with a very low plate potential, in this way effecting good buffer action and stability. While the 46 tube might have been used, it has some disadvantage due to secondary emission difficulties on the higher frequencies. The oscillator used was the good old and trustworthy type 47. After the tube types are considered, the type of coupling must be determined. Since three low power stages were placed on the same chassis, it was decided to use capacity coupling between the oscillator and first and second buffers. Link coupling was used between the second buffer and final stage. Frequency doubling was done in the first buffer stage, the second buffer always operating on the same frequency as the final stage.

The matter of bias is always a problem to the average ham. Here is how the problem was attacked in this case. Cathode bias having no advantage over leak bias in the oscillator, the latter type was selected because it required less parts. Leak bias appears simple but has one serious disadvantage. Using this

method, grid bias is obtained from the rectified RF excitation voltage. The voltage drop across the leak biases the grid negatively. Should the crystal stop oscillating, or if the exciting voltage were removed from the grid leak biased tube for any reason, known or unknown, the tube is left without bias and the plate current then will soar to a value determined by the value of the plate resistance of the tube and the capacity of the plate supply. These high plate currents are naturally highly injurious to the tubes. Since the type 841 is a high mu tube, loss of bias causes no damage to it, the plate current dropping to a low value when the excitation is removed. In the final stage, both grid leak method makes necessary a large value of condenser shunting the bias resistor to eliminate degeneration. Inasmuch as failure in the cathode resistor might ruin a pair of perfectly good tubes, an overload relay is used in the plate supply of the final stage. This relay, a Ward-Leonard 250 MA type, acts to break the primary circuit of the power transformer, should the average value of the plate current rise over 250 MA. This shuts off the power in both the final Class C stage and the modulators. It is of considerable advantage to cut off both stages simultaneously, as the output transformer might be damaged if operated unloaded. Extensive oscillographic tests by the writer on Class B sys-

tems of this nature indicate that voltages in the vicinity of 10,000 volts peak are frequently obtained when 800's are operated with maximum input and no load. Another Ward-Leonard relay of the time delay type allows the 866 A's to come up to operating temperature before plate voltage is applied.

The neutralizing system of this transmitter differs slightly from the usual run. Since it was desired to make the coils up with as few taps as possible, the split-stator condenser method of neutralizing the buffer stages, was employed. Another advantage of the split-stator system is the fact that once neutralized, the particular stage need never be touched again. This does not always hold true as there are generally slight inequalities in the condenser sections. However, if the coils for the various bands are properly designed so that the frequency to which one desires to tune falls on approximately the same condenser setting, this effect is practically eliminated. Cross neutralization is obtained in the final amplifier using Hammarlund neutralizing condensers. The condensers for this stage can be made from old variable condenser plates spaced at least one-quarter of an inch apart, one plate being movable.

The rear view of the transmitter shown in Fig. 2 indicates the placing of the various parts. The simple sectionalizing of units is apparent at first glance. The bottom section of the rack contains the power supply for the Class C final and modulator stages. The second section of the rack includes the power supplies for the low power and speech amplifier stages and also the bias supply for the Class B modulator tubes. The third section of the rack contains the entire audio amplifier. The front of this panel includes the master gain control, input plug, and a plate current indicator for the Class B tubes. The back of the chassis has controls to balance up the plate currents of the 800's and to adjust the plate currents of the 2A3's. The RF structure is readily apparent from the illustration. Provision is made through the use of patch cords to determine the plate currents and plate voltages of all tubes in the entire system.

Should it be desired at any time to change a portion of the circuit, it is only necessary to withdraw the connecting plugs and remove the particular section desired from the rack. This method of construction is also an advantage where the ham has to gradually build up the sections at intervals proportional to the rate of capital influx.

Properly constructed, this phone transmitter can put an honestly clean 106 watts of power into the antenna. A unit of somewhat similar structure operated in the vicinity of New York City has already contacted over fifty European stations, in many cases receiving reports of R-9 reception.

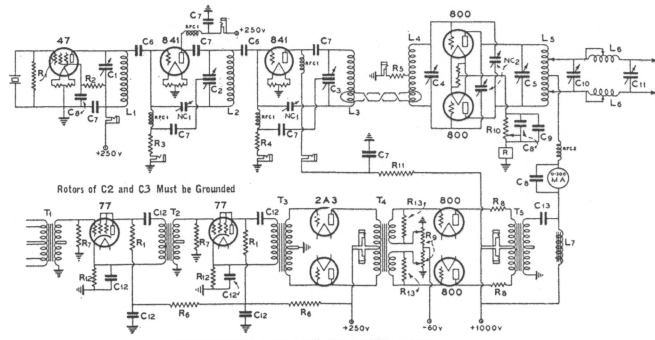

CONSTANTS AND LIST OF PARTS USED

- R1—25,000 ohms, 1 watt, Tru-test.  
R2—30,000 ohms, 3 watt, Tru-test.  
R3—9,000 ohms, 3 watt, Tru-test.  
R4—10,000 ohms, 20 watt, Tru-test.  
R5—1,000 ohms, 50 watt, Tru-test.  
R6—30,000 ohms, 1 watt, Tru-test.  
R7—1/2 meg., 1 watt, Tru-test.  
R8—50 ohms, 3 watt, Tru-test.  
R9—800 ohms, 20 watt, Electro-rad.  
R10—500 ohms. R12—2,000 ohms.  
R11—8,000 ohms. R13—20,000 ohms.  
C1—100 mmfd. Hammarlund Midget.  
C2, C3—140 mmfd. total Hammarlund Dual Midget.  
C4—100 mmfd. Hammarlund TC 100B.  
C5—100 mmfd. Hammarlund TC 100A.  
C6—100 mmfd. Dubilier Type 4, High Voltage.  
C7—.001 mfd. Dubilier Type 4, High Voltage.  
C8—.01 mfd. Dubilier Type 4, High Voltage.  
C9—32 mfd. Dubilier Type Ev, 450 W.V. Electrolytic.  
C10—350 mmfd. Hammarlund TC 350 C.  
C11—225 mmfd. Hammarlund TC 225 C.  
C12—1 mfd. Dubilier, Paper, 400 W.V.  
C13—1 mfd. Dubilier, Transmitting, 1500 W.V.  
C14—2 mfd. Dubilier, Transmitting, 1500 W.V.  
C15—8 mfd. Dubilier, 450 W.V. Electrolytic.  
Nc2—Hammarlund Special 800 Neut. Cond.  
L1, L2, L3, L4, L5, L6—Hammarlund Coil Forms.  
L7—United Transformer Mod. Choke Type 151.  
L8—United Transformer Swinging Choke Type PA-109.  
L9—United Transformer Filter Choke Type PA-108.  
L10—United Transformer 25 hy. 150 MA. Choke Type PA-101.  
L11—United Transformer 8 hy. 150 MA. Choke Type PA-101.  
RFC1—Hammarlund Midget Chokes.  
RFC2—Hammarlund Large Choke.  
T1—United Transformer Line-to-Grid Type HA-100.  
T2—United Transformer Plate to Grid Type HA-105.  
T3—United Transformer Plate to 2 Grids Type HA-106.  
T4—United Transformer Class B Input Type PA-57.  
T5—United Transformer Class B Output Type PA-82.  
T6—United Transformer Type PA-112.  
T7—United Transformer Type PA-34.  
T8—United Transformer Type PA-123.  
T9—United Transformer Type PA-115.  
T10—United Transformer Type PA-22A.

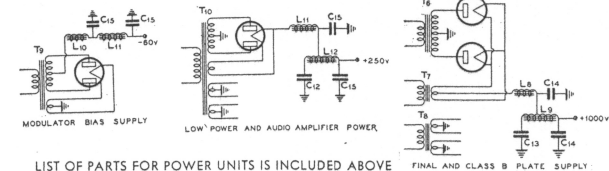

LIST OF PARTS FOR POWER UNITS IS INCLUDED ABOVE

## DX NEWS

(Continued from page 15)

the possibility of being a station in India after all. Well, unless this thing is settled it may blossom into a feud between those who worked VU2CP and those who called him. Hi!

OEIC called W6AHZ for ten minutes with no avail. Sorry, OB, couldn't stand it any longer so called and worked him myself.

W6BIP is losing lots of DX because he is dazed by the Europeans answering W6CUIH-QD, and a long silence from QD. We understand his location is bad for Europe and that merely moving the receiver a short distance away brings 'em all in. Tuff, what?

And a letter to us from ZS2A should interest a lot of us . . .

"Dear Sir:

I shall be pleased if you will intimate to hams through the medium of your most excellent journal that I will reply to all QSL's received, per QSL distribution service, as I find that postage on individual cards is too heavy a drain on my funds.

Thanking you and wishing you every success,

I remain, yours truly,  
(Signed) O. L. Reid, ZS2A."

We quote a letter received from that old dyed-in-the-wool DX'er, W7BB . . . "I'm using a fifth harmonic antenna—300 feet long, working about a quarter wave, 35 foot counterpoise. . . worked OK1PK, PY2AJ, ZS2A, ZL3AN and J2IN in two hours and seven minutes, on 7 MC only. . . "23 VK

and ZL in one morning." This beats W6QD's record of 21. Fine business any way you look at it, Ed.

And a radiogram from KA1NA:

"Refer your fine article April 'RADIO' on antenna slant Stop You mention east-west directions rather than great circle course Stop Could greatly improve directional characteristics for DX by measuring these on a globe rather than using mercator directions Stop My beam antenna for east coast is laid out to peak twenty-nine degrees east of north instead of ninety degrees Stop Your angle for Asia is about forty-five degrees west of north Stop For Europe about forty-five degrees of north Stop 73

(Signed) Red Grave, KA1NA."

# RADIO TELEPHONY

By LINEAR

## Bias Rectifier For Class B Audio

BECAUSE grid current drawn by a class B audio amplifier (or RF linear amplifier) varies with the amplitude of the speech, it is necessary to obtain the grid bias voltage from a bias source whose output voltage does not vary when the grid current varies. In most cases batteries are the simplest answer. However, dry B batteries are unreliable and get noisy because the grid current flows in the direction of CHARGE rather than discharge, as in the ideal bias source for this type of amplifier. The old storage B battery whose cells were about two inches in diameter and about six inches high. (Avoid the test tube B batteries as they go haywire under the high charging current). However, these old B batteries are very scarce now and many inquiries have been received for a full AC operated bias supply. In Fig. 1 is shown such a RAC bias supply. A special transformer is required and both the primary and secondary should be tapped, for maximum flexibility. The secondary taps are used for rough adjustment of the output voltage and the primary taps provide a fine adjustment. The 10 ohm two-arm potentiometer allows the operator to balance up the bias supplied to each half of the class B stage. This helps materially to balance out the second harmonic distortion, as it is very unusual to find two tubes of exactly identical characteristics. No bypass is needed across the two arms of the potentiometer because ten ohms is the maximum possible resistance added to the grid circuit.

A General Radio "VARIAC" could be used as an autotransformer in the primary side of the transformer if no tapped primary transformer is available.

It should be noted that no SERIES RESISTANCE should be used to vary the output voltage of the

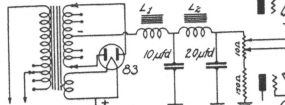

FIG. 1 - B-40 Hz @ 400ma swinging choke  
L1 - 2 H @ 400ma smoothing choke  
L2 - 2 H @ 400ma smoothing choke  
Class B input 211-203A  
R1-4-240  
R2-800-830B

bias supply because series resistances reduce the voltage regulation. The transformer and chokes must have low IR resistance, also for purposes of voltage regulation. The total bleeder of 160 ohms means that considerable current will flow through it, so make it husky enough to handle to necessary power.

## Articulation and Audio Power

ARTICULATION and intelligibility are closely related, although intelligible reproduction is not necessarily natural reproduction. It has been found that 1500 cycles per second is the center of the articulate speech band. If all audio frequencies above 1500 cycles are cut off the speech is still 65% articulate, and 12% of the sound energy has been eliminated. However, think this one... If all the frequencies BELOW 1500 cycles are cut off, the speech is STILL 65% articulate, BUT all but 12% of the sound energy has been ELIMINATED. Suppose we put a high-pass filter in the speech amplifier of our phone transmitter and only pass the frequencies from 1500 up. We would then have reduced the articulation to two-thirds of normal (65%) but our signal would be EIGHT times louder. It looks to me as if a real gain in DX might be effected by this means. Of course, additional gain in the speech amplifier would be necessary, but nothing else in the transmitter need be changed. Naturally, a high quality receiver would be necessary to preserve what remained of the articulation.

## High Power Audio

WLW They use 400 KW of audio power to modulate 800 KW of input to the final amplifier. This 400 KW of audio power comes from a number of tubes in push-pull-parallel. In England, recently, they built a class B amplifier which uses four 100 KW tubes in push-pull-parallel. For an experiment they coupled it to a 50-mile high tension line, which I do not know over what distance they worked, but a 2 KC should act like other long waves, only more so. It is not generally known, but most of the credit for class B audio should go to WGLH, who is said to have discovered its possibilities as a high efficiency audio amplifier.

## The Useful 2B6 Triple Twin Power Amplifier

THE 2B6 consists of two triodes in one envelope. One is a voltage amplifier and the other is a hunky power amplifier. It somewhat resembles a combination 56 and 45. However, the output section gives an honest 8 watts at 350 volts on the plate, with less than 5% total harmonic distortion. A pair of 250's at this plate voltage will hardly do as well. The two 250's would require about 60 120 volts across the two grids if connected in push-pull, while the 2B6 requires ONLY THREE VOLTS applied to the grid of the input triode, to obtain the same output. This means that a single 56 preamplifier would provide sufficient gain to enable one to use even the low-level types of double button carbon mikes, and still get full output. If, instead of the 56 preamplifier we use a 57, we can use a close-talking ribbon or crystal mike. The output of the 2B6 is sufficient to drive two or four 4's

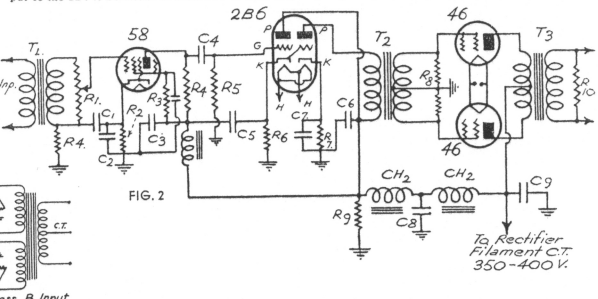

FIG. 2 Three-Stage Class B Amplifier. Gain 90 db. With 25 Watts Output

R1-200,000 ohms tapered volume control. R2-500 ohms, 1 watt. R3-1.5 megohm, 1 watt. R4-1/2 megohm, 1 watt. R5-1 megohm, 1 watt. R6-7500 ohms, 2 watts. R7-250 ohms, 10 watts. R8-20,000 ohms, 5 watts. R9-20,000 ohm bleeder. R10-Variac, 10% of load impedance. T1-Mike, or line-to-grid transformer. C1-1.5-1 step-down. C2-Class B Output. CH1-100 ohms at 3 mils. CH2-30 ohms, 50 mils. C1, C2, C3, C5-1/4 mfd. C4-1 mfd. C6-10 mfd. C7-600 volts. C8, C9-10 mfd., 25 volts. C8, C9-10 mfd., 25 volts.

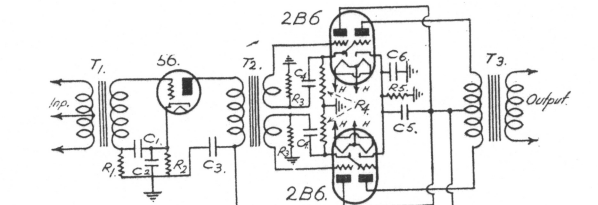

FIG. 3 Two-Stage Amplifier with 15 Watt Output. Gain 66 db.

R1-0.1 mfd., 1/2 watt. R2-2500 ohms, 2 watt. R3-1/10 meg., 1 watt. R4-8000 ohms, 2 watts. R5-300 ohms, 20 watts. C1, C2, C3, C4, C5-1/2 mfd, each. C6-25 mfd, 25 volts. T1-Mike, or line-to-grid transformer. T2-56 to push-pull grids, split secondary transformer. T3-20 watts Class A Prime output transformer, plate-to-plate lead, 20,000 ohms.

## Audio Fidelity

FOR an audio amplifier to have perfect fidelity it must amplify all audio frequencies equally well. Five years ago, broadcast and sound engineers considered that flat amplification over the band of 100 to 4,000 cycles represented practically perfect quality. Two years ago the band from 80 to 8,000 cycles was considered necessary, and now engineers demand that a high quality amplifier show no discrimination to any frequen-

cy or 210's in class B. If we want to use two 2B6's in push-pull, we can obtain nearly 20 watts of audio power, which will drive a pair of 20A's or 830B's in class B with an output close to 200 watts of audio power.

How does the 2B6 manage to give 8 watts output when the output portion of the tube closely resembles a 45? This is possible because the grid of the output triode goes somewhat positive on the voice peaks. How about distortion? Due to the special design of the tube, this grid current distortion is compensated for in the complementary characteristics of the two triodes. Direct coupling is used between the input and output portions of the tube, so that no loss in fidelity is produced at this point. The voltage gain of 100, low load impedance and high fidelity makes this tube a tough competitor for the pentode group. In Fig. 2 a complete speech amplifier is shown which has an output of more than 25 watts of audio power. In Fig. 3 we show the push-pull stage driven by a single 56, with a gain of over 66 DB.

# The 3-Tube Economy Superheterodyne

By GEORGE B. HART

IN THE general rush to build highly selective and sensitive receivers suitable for modern amateur phone and CW reception most amateur designers have overlooked the possibilities of efficient circuit design. It is a fact that the use of tubes such as the 2A7 and 6A7 enable the set constructor to design and build a high-frequency receiver selective and sensitive enough to satisfy even the most discriminating ham without breaking the bank roll.

With these few facts in mind we spent all of one night designing and constructing the simple superheterodyne shown in Fig. 1. The set utilizes two type 2A7's or 6A7's to obtain the greatest efficiency ever experienced with such a small receiver. The first tube operates as first detector and modulator, while the second effectively handles the triple job of intermediate frequency amplifier, second detector, and audio frequency amplifier. The inherent electron coupling of these tubes

of regeneration effectively eliminates the necessity of a beat frequency oscillator for CW reception; thereby doing away with one tube.

The set as constructed uses a self-contained power supply employing 60 henrys and 24

wind 75 turns of No. 32 enameled wire around the center of the transformer. Bring the leads from this coil out through the TOP of the can to keep them well away from all other leads originating within the transformer.

The values of condensers and resistors shown in the circuit are quite important for proper control of the several duties that each tube is required to perform. The leads from the tuning condenser to the coils and the trimmer should be shielded in order to reduce stray pick-ups. The plug-in coils are orthodox in every way, standard manufactured octo coils being used to cover the two combinations of L1, L4 and L2, L3, in which L3 and L4 are the tickler windings. The coils should be shielded from each other. The complete receiver may be mounted on a 7-in. by 12-in. aluminum panel and enclosed in a metal cabinet.

The volume control of 2,000 ohms may be eliminated, but we found it very useful because the set has sufficient punch to effectively operate either a dynamic or a magnetic speaker on most foreign stations, while headphone reception is always uncomfortable due to the great signal strength.

The use of a larger tuning condenser than is ordinarily seen in an amateur receiver allows a degree of selectivity in the signal circuit which is impossible to achieve when a smaller capacity is used, the added selectivity being due, of course, to the fact that less inductance and consequently less resistance is in the circuit at any particular frequency. Dynamic stability in a receiver is just as important as in a transmitter, and since we have been able to use the trimming condenser as an effective band spreading device over a small band of frequencies, we welcome this opportunity to improve the bug-a-boo of most inexpensive amateur receivers—selectivity, without which we might as well turn off the power and go to bed.

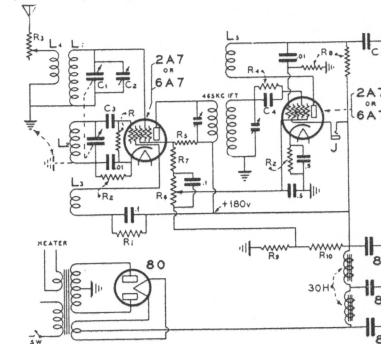

R-100,000 ohms. R1-20,000 ohms. R2-400 ohms. R3-2,000 ohms. R4-3 megohms. R5-90,000 ohms. R6-30,000 ohms. R7-500 ohms, 1 watt. R8-1/4 meg. R9-2,000 ohms, 25 watt. R10-20,000 ohms, 25 watt. C1-140 mmf. (gang.-ed). C2-35 mmf. C3-200 mmf. C4-100 mmf. C5-500 mmf. J-Phone Jack.

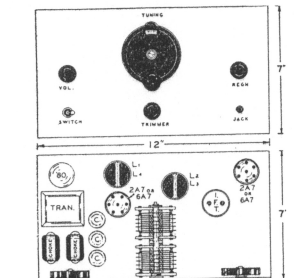

Front Panel View and Baseboard Layout

makes the set very easy to handle, while the presence of regeneration in the second detector increases the set's sensitivity and at the same time greatly increases selectivity. This

microfarads of filter to eliminate all vestige of AC hum from the signal. If any hum gets through to the receiver it modulates the signal to such an extent as to make reception very poor. Use a good filter.

The diagrams and schematic are self-explanatory, and the most inexperienced amateur should have no difficulty in constructing this modern little set. An air-tuned IF transformer is used because these hold their calibration indefinitely. In winding L5; the regeneration return coil, remove the transformer from its shielding can and bunch-

Good lists of DX calls-heard are solicited. Send them to the Editor.

## Calls Heard at WICNU, Stamford, Conn.

20 METERS  
G2AV, G2BH, G2BM, G2DC, G2DI, G2DL, G2DV, G2DK, G2HF, G2HP, G2KM, G2LA, G2LZ, G2MA, G2MC, G2ML, G2NH, G2OJ, G2PN, G2QO, G2RF, G2VF, G2WV, G2XL, G2XQ, G2ZP. Heard on fone: G2GF, G2SD.  
G2BD, G2B, G2GQ, G2IZ, G2JU, G2NF, G2NI, G2PF, G2QY, G2SR, G2UC, G2UY, G2VE, G2VQ, G2WB, G2WR, G2XB, G2YH, G2YJ, G2YV. Heard on fone: G2BY, G2CV, G2ML, G2WC, G2GS, G2GJ, G2BK, G2BY, G2CT, G2CW, G2G6, G2G5, G2G6, G2GQ, G2GY, G2GR, G2BV, G2TT, G2UF, G2VP, G2VQ, G2XK, G2XQ, G2ZP, G2ZU. Heard on fone: G2DL, G2LI, G2PY, G2RL, F2BMX, F2BE, F2OE, F2GD, F2GG, F2SKV, F2FT, F2RI, F2ST, F2UQ, F2VK, F2VT. Heard on fone: F2PV.  
CT1BC, CT1CC, CT2AP, CT2BK, CT2AD. Heard fone: CT1Y.  
D4BU, D4BC, D4BD, D4BN, D4BG, D4BU, D4BJ, D4BK, D4BKN, D4BL, D4BP, D4BS, D4BU, D4CA, D4JAG, D4JG, EA1BB, EA2AD, EA3AN, EA4AV, EA4BG, EA5AF, EA5BA, EA5BE, EA7AO.

## Calls Heard

OK1BC, OK1GK, OK1JK, OK1WX, OK2KP, OK2MA, OK2MS. Heard on fone: LU6CR.  
ON4AU, ON4BZ fone and CW. ON4CSL, ON4DX, ON4FE, ON4GU, ON4GW, ON4HP, ON4JE, ON4MD, ON4MY, ON4PY. Heard on fone: ON4BC, ON4ACE.  
SM5Y, SM5Z, SM6TIA, SM7SG, SM7WS, SM7Y, OZ3J, OZ5R, OZ7HL, OZ8D. E1D, LY1J, G15X, YU7VY, LA3C, IU1L, Y2EA, NY2AL, SU156, OK2AM. PA0AZ, PA0CE, PA0CO, PA0DC, PA0FX, PA0HG, PA0JM, PA0KT, PA0LK, PA0MH, PA0PF, A00L, X10RA, X10Z, PA0SM, PA0VB, PA0VJ, PA0VK, PA0XF, PA0XG, PA0XK, PA0ZT. PY2BW, PY2AD, PY1IC, PY1IG, T12WD, Y1IA, VO8W, UIDC, H18X, FM8CR, FM8DA, SP1AR, SP1BC, SP1DC, HB9AQ, HB9B, HB9J, HB9W, HB9Y, VP2BX, VP2BT, VP4TB, VP4AA, VP2PZ.  
HCL1W, HCL1Z. Heard on fone: HC1CF, X1AC, X1AM, X1BR, X1C, X1D, X1E. Heard on fone: X1A, X1I, X1G, K4AP, K4KD, K4SA on fone: K5AA, K5AE, K5AF, K5DK. P0WJ, P0XK, P0YK, G2DK, G2AX, G2BM, G2BY, G2DC, G2DF, G2DI, G2DG, G2HF, G2KZ, G2LA, G2MA, G2NK, G2OA, G2OC, G2OL, G2QO, G2UE, G2V, G2VY, G2WM, G2XC, G2Y, G2OC, G2OF, G2QA, G2QY, G2RX, G2SR, G2VB, G2VM, G2WR, G2XT, G2YX, G2YH, G2LV, G2LX, G2CI, G2CT, G2BL, G2CV, G2CQ, G2GQ, G2GB, G2GV, G2JT, G2ZA, G2ZB, G2ZC, G2ZD, G2ZE, G2ZF, G2ZG, G2ZH, G2ZJ, G2ZK, G2ZL, G2ZM, G2ZN, G2ZO, G2ZP, G2ZQ, G2ZR, G2ZS, G2ZT, G2ZU, G2ZV, G2ZW, G2ZX, G2ZY, G2ZZ, G2ZAA, G2ZAB, G2ZAC, G2ZAD, G2ZAE, G2ZAF, G2ZAG, G2ZAH, G2ZAI, G2ZAJ, G2ZAK, G2ZAL, G2ZAM, G2ZAN, G2ZAO, G2ZAP, G2ZAQ, G2ZAR, G2ZAS, G2ZAT, G2ZAU, G2ZAV, G2ZAW, G2ZAX, G2ZAY, G2ZAZ, G2ZBA, G2ZBB, G2ZBC, G2ZBD, G2ZBE, G2ZBF, G2ZBG, G2ZBH, G2ZBI, G2ZBJ, G2ZBK, G2ZBL, G2ZBM, G2ZBN, G2ZBO, G2ZBP, G2ZBQ, G2ZBR, G2ZBS, G2ZBT, G2ZBU, G2ZBV, G2ZBW, G2ZBX, G2ZBY, G2ZBZ, G2ZCA, G2ZCB, G2ZCC, G2ZCD, G2ZCE, G2ZCF, G2ZCG, G2ZCH, G2ZCI, G2ZCJ, G2ZCK, G2ZCL, G2ZCM, G2ZCN, G2ZCO, G2ZCP, G2ZCQ, G2ZCR, G2ZCS, G2ZCT, G2ZCU, G2ZCV, G2ZCW, G2ZCX, G2ZCY, G2ZCZ, G2ZDA, G2ZDB, G2ZDC, G2ZDD, G2ZDE, G2ZDF, G2ZDG, G2ZDH, G2ZDI, G2ZDJ, G2ZDK, G2ZDL, G2ZDM, G2ZDN, G2ZDO, G2ZDP, G2ZDQ, G2ZDR, G2ZDS, G2ZDT, G2ZDU, G2ZDV, G2ZDW, G2ZDX, G2ZDY, G2ZDZ, G2ZEA, G2ZEB, G2ZEC, G2ZED, G2ZEE, G2ZEF, G2ZEG, G2ZEH, G2ZEI, G2ZEJ, G2ZEK, G2ZEL, G2ZEM, G2ZEN, G2ZEO, G2ZEP, G2ZEQ, G2ZER, G2ZES, G2ZET, G2ZEU, G2ZEV, G2ZEW, G2ZEX, G2ZEY, G2ZEZ, G2ZFA, G2ZFB, G2ZFC, G2ZFD, G2ZFE, G2ZFF, G2ZFG, G2ZFH, G2ZFI, G2ZFJ, G2ZFK, G2ZFL, G2ZFM, G2ZFN, G2ZFO, G2ZFP, G2ZFQ, G2ZFR, G2ZFS, G2ZFT, G2ZFU, G2ZFV, G2ZFW, G2ZFX, G2ZFY, G2ZFZ, G2ZGA, G2ZGB, G2ZGC, G2ZGD, G2ZGE, G2ZGF, G2ZGG, G2ZGH, G2ZGI, G2ZGJ, G2ZGK, G2ZGL, G2ZGM, G2ZGN, G2ZGO, G2ZGP, G2ZGQ, G2ZGR, G2ZGS, G2ZGT, G2ZGU, G2ZGV, G2ZGW, G2ZGX, G2ZGY, G2ZGZ, G2ZHA, G2ZHB, G2ZHC, G2ZHD, G2ZHE, G2ZHF, G2ZHG, G2ZHI, G2ZHJ, G2ZHK, G2ZHL, G2ZHM, G2ZHN, G2ZHO, G2ZHP, G2ZHQ, G2ZHR, G2ZHS, G2ZHT, G2ZHU, G2ZHV, G2ZHW, G2ZHX, G2ZHY, G2ZHZ, G2ZIA, G2ZIB, G2ZIC, G2ZID, G2ZIE, G2ZIF, G2ZIG, G2ZIH, G2ZII, G2ZIJ, G2ZIK, G2ZIL, G2ZIM, G2ZIN, G2ZIO, G2ZIP, G2ZIQ, G2ZIR, G2ZIS, G2ZIT, G2ZIU, G2ZIV, G2ZIW, G2ZIX, G2ZIY, G2ZIZ, G2ZJA, G2ZJB, G2ZJC, G2ZJD, G2ZJE, G2ZJF, G2ZJG, G2ZJH, G2ZJI, G2ZJJ, G2ZJK, G2ZJL, G2ZJM, G2ZJN, G2ZJO, G2ZJP, G2ZJQ, G2ZJR, G2ZJS, G2ZJT, G2ZJU, G2ZJV, G2ZJW, G2ZJX, G2ZJY, G2ZJZ, G2ZKA, G2ZKB, G2ZKC, G2ZKD, G2ZKE, G2ZKF, G2ZKG, G2ZKH, G2ZKI, G2ZKJ, G2ZKL, G2ZKM, G2ZKN, G2ZKO, G2ZKP, G2ZKQ, G2ZKR, G2ZKS, G2ZKT, G2ZKU, G2ZKV, G2ZKW, G2ZKX, G2ZKY, G2ZKZ, G2ZLA, G2ZLB, G2ZLC, G2ZLD, G2ZLE, G2ZLF, G2ZLG, G2ZLH, G2ZLI, G2ZLJ, G2ZLK, G2ZLL, G2ZLM, G2ZLN, G2ZLO, G2ZLP, G2ZLQ, G2ZLR, G2ZLS, G2ZLT, G2ZLU, G2ZLV, G2ZLW, G2ZLX, G2ZLY, G2ZLZ, G2ZMA, G2ZMB, G2ZMC, G2ZMD, G2ZME, G2ZMF, G2ZMG, G2ZMH, G2ZMI, G2ZMJ, G2ZMK, G2ZML, G2ZMN, G2ZMO, G2ZMP, G2ZMQ, G2ZMR, G2ZMS, G2ZMT, G2ZMU, G2ZMV, G2ZMW, G2ZMX, G2ZMY, G2MZ, G2ZNA, G2ZNB, G2ZNC, G2ZND, G2ZNE, G2ZNF, G2ZNG, G2ZNH, G2ZNI, G2ZNJ, G2ZNK, G2ZNL, G2ZNM, G2ZNO, G2ZNP, G2ZNQ, G2ZNR, G2ZNS, G2ZNT, G2ZNU, G2ZNV, G2ZNW, G2ZNX, G2ZNY, G2NZ, G2ZOA, G2ZOB, G2ZOC, G2ZOD, G2ZOE, G2ZOF, G2ZOG, G2ZOH, G2ZOI, G2ZOJ, G2ZOK, G2ZOL, G2ZOM, G2ZON, G2ZOO, G2ZOP, G2ZOQ, G2ZOR, G2ZOS, G2ZOT, G2ZOU, G2ZOV, G2ZOW, G2ZOX, G2ZOY, G2ZOZ, G2ZPA, G2ZPB, G2ZPC, G2ZPD, G2ZPE, G2ZPF, G2ZPG, G2ZPH, G2ZPI, G2ZPJ, G2ZPK, G2ZPL, G2ZPM, G2ZPN, G2ZPO, G2ZPP, G2ZPQ, G2ZPR, G2ZPS, G2ZPT, G2ZPU, G2ZPV, G2ZPW, G2ZPX, G2ZPY, G2PZ, G2ZQA, G2ZQB, G2ZQC, G2ZQD, G2ZQE, G2ZQF, G2ZQG, G2ZQH, G2ZQI, G2ZQJ, G2ZQK, G2ZQL, G2ZQM, G2ZQN, G2ZQO, G2ZQP, G2ZQQ, G2ZQR, G2ZQS, G2ZQT, G2ZQU, G2ZQV, G2ZQW, G2ZQX, G2ZQY, G2ZQZ, G2ZRA, G2ZRB, G2ZRC, G2ZRD, G2ZRE, G2ZRF, G2ZRG, G2ZRH, G2ZRI, G2ZRJ, G2ZRK, G2ZRL, G2ZRM, G2ZRN, G2ZRO, G2ZRP, G2ZRQ, G2ZRR, G2ZRS, G2ZRT, G2ZRU, G2ZRV, G2ZRW, G2ZRX, G2ZRY, G2ZRZ, G2ZSA, G2ZSB, G2ZSC, G2ZSD, G2ZSE, G2ZSF, G2ZSG, G2ZSH, G2ZSI, G2ZSJ, G2ZSK, G2ZSL, G2ZSM, G2ZSN, G2ZSO, G2ZSP, G2ZSQ, G2ZSR, G2ZSS, G2ZST, G2ZSU, G2ZSV, G2ZSW, G2ZSX, G2ZSY, G2SZ, G2ZTA, G2ZTB, G2ZTC, G2ZTD, G2ZTE, G2ZTF, G2ZTG, G2ZTH, G2ZTI, G2ZTJ, G2ZTK, G2ZTL, G2ZTM, G2ZTN, G2ZTO, G2ZTP, G2ZTQ, G2ZTR, G2ZTS, G2ZTT, G2ZTU, G2ZTV, G2ZTW, G2ZTX, G2ZTY, G2TZ, G2ZUA, G2ZUB, G2ZUC, G2ZUD, G2ZUE, G2ZUF, G2ZUG, G2ZUH, G2ZUI, G2ZUJ, G2ZUK, G2ZUL, G2ZUM, G2ZUN, G2ZUO, G2ZUP, G2ZUQ, G2ZUR, G2ZUS, G2ZUT, G2ZUU, G2ZUV, G2ZUW, G2ZUX, G2ZUY, G2ZUZ, G2ZVA, G2ZVB, G2ZVC, G2ZVD, G2ZVE, G2ZVF, G2ZVG, G2ZVH, G2ZVI, G2ZVJ, G2ZVK, G2ZVL, G2ZVM, G2ZVN, G2ZVO, G2ZVP, G2ZVQ, G2ZVR, G2ZVS, G2ZVT, G2ZVU, G2ZVV, G2ZVW, G2ZVX, G2ZVY, G2VZ, G2ZWA, G2ZWB, G2ZWC, G2ZWD, G2ZWE, G2ZWF, G2ZWG, G2ZWH, G2ZWI, G2ZWJ, G2ZWK, G2ZWL, G2ZWM, G2ZWN, G2ZWO, G2ZWP, G2ZWQ, G2ZWR, G2ZWS, G2ZWT, G2ZWU, G2ZWV, G2ZWW, G2ZWX, G2ZWY, G2WZ, G2ZXA, G2ZXB, G2ZXC, G2ZXD, G2ZXE, G2ZXF, G2ZXG, G2ZXH, G2ZXI, G2ZXJ, G2Z XK, G2ZXL, G2ZXM, G2Z XN, G2Z XO, G2Z XP, G2Z XQ, G2Z XR, G2Z XS, G2Z XT, G2Z XU, G2Z XV, G2Z XW, G2Z X X, G2Z XY, G2Z XZ, G2Z YA, G2Z YB, G2Z YC, G2Z YD, G2Z YE, G2Z YF, G2Z YG, G2Z YH, G2Z YI, G2Z YJ, G2Z YK, G2Z YL, G2Z YM, G2Z YN, G2Z YO, G2Z YP, G2Z YQ, G2Z YR, G2Z YS, G2Z YT, G2Z YU, G2Z YV, G2Z YW, G2Z YX, G2Z YY, G2Z YZ, G2Z ZA, G2Z ZB, G2Z ZC, G2Z ZD, G2Z ZE, G2Z ZF, G2Z ZG, G2Z ZH, G2Z ZI, G2Z ZJ, G2Z ZK, G2Z ZL, G2Z ZM, G2Z ZN, G2Z ZO, G2Z ZP, G2Z ZQ, G2Z ZR, G2Z ZS, G2Z ZT, G2Z ZU, G2Z ZV, G2Z ZW, G2Z ZX, G2Z ZY, G2ZZ, G2ZAA, G2ZAB, G2ZAC, G2ZAD, G2ZAE, G2ZAF, G2ZAG, G2ZAH, G2ZAI, G2ZAJ, G2ZAK, G2ZAL, G2ZAM, G2ZAN, G2ZAO, G2ZAP, G2ZAQ, G2ZAR, G2ZAS, G2ZAT, G2ZAU, G2ZAV, G2ZAW, G2ZAX, G2ZAY, G2ZAZ, G2ZBA, G2ZBB, G2ZBC, G2ZBD, G2ZBE, G2ZBF, G2ZBG, G2ZBH, G2ZBI, G2ZBJ, G2ZBK, G2ZBL, G2ZBM, G2ZBN, G2ZBO, G2ZBP, G2ZBQ, G2ZBR, G2ZBS, G2ZBT, G2ZBU, G2ZBV, G2ZBW, G2ZBX, G2ZBY, G2ZBZ, G2ZCA, G2ZCB, G2ZCC, G2ZCD, G2ZCE, G2ZCF, G2ZCG, G2ZCH, G2ZCI, G2ZCJ, G2ZCK, G2ZCL, G2ZCM, G2ZCN, G2ZCO, G2ZCP, G2ZCQ, G2ZCR, G2ZCS, G2ZCT, G2ZCU, G2ZCV, G2ZCW, G2ZCX, G2ZCY, G2ZCZ, G2ZDA, G2ZDB, G2ZDC, G2ZDD, G2ZDE, G2ZDF, G2ZDG, G2ZDH, G2ZDI, G2ZDJ, G2ZDK, G2ZDL, G2ZDM, G2ZDN, G2ZDO, G2ZDP, G2ZDQ, G2ZDR, G2ZDS, G2ZDT, G2ZDU, G2ZDV, G2ZDW, G2ZDX, G2ZDY, G2ZDZ, G2ZEA, G2ZEB, G2ZEC, G2ZED, G2ZEE, G2ZEF, G2ZEG, G2ZEH, G2ZEI, G2ZEJ, G2ZEL, G2ZEM, G2ZEN, G2ZEO, G2ZEP, G2ZEQ, G2ZER, G2ZES, G2ZET, G2ZEU, G2ZEV, G2ZEW, G2ZEX, G2ZEY, G2ZEZ, G2ZFA, G2ZFB, G2ZFC, G2ZFD, G2ZFE, G2ZFF, G2ZFG, G2ZFH, G2ZFI, G2ZFJ, G2ZFK, G2ZFL, G2ZFM, G2ZFN, G2ZFO, G2ZFP, G2ZFQ, G2ZFR, G2ZFS, G2ZFT, G2ZFU, G2ZFV, G2ZFW, G2ZFX, G2ZFY, G2ZFZ, G2ZGA, G2ZGB, G2ZGC, G2ZGD, G2ZGE, G2ZGF, G2ZGG, G2ZGH, G2ZGI, G2ZGJ, G2ZGK, G2ZGL, G2ZGM, G2ZGN, G2ZGO, G2ZGP, G2ZGQ, G2ZGR, G2ZGS, G2ZGT, G2ZGU, G2ZGV, G2ZGW, G2ZGX, G2ZGY, G2ZGZ, G2ZHA, G2ZHB, G2ZHC, G2ZHD, G2ZHE, G2ZHF, G2ZHG, G2ZHI, G2ZIJ, G2ZIK, G2ZIL, G2ZIM, G2ZIN, G2ZIO, G2ZIP, G2ZIQ, G2ZIR, G2ZIS, G2ZIT, G2ZIU, G2ZIV, G2ZIW, G2ZIX, G2ZIY, G2ZIZ, G2ZJA, G2ZJB, G2ZJC, G2ZJD, G2ZJE, G2ZJF, G2ZJG, G2ZJH, G2ZJI, G2ZJK, G2ZJL, G2ZJM, G2ZJN, G2ZJO, G2ZJP, G2ZJQ, G2ZJR, G2ZJS, G2ZJT, G2ZJU, G2ZJV, G2ZJW, G2ZJX, G2ZJY, G2ZJZ, G2ZKA, G2ZKB, G2ZKC, G2ZKD, G2ZKE, G2ZKF, G2ZKG, G2ZKH, G2ZKI, G2ZKJ, G2ZKL, G2ZKM, G2ZKN, G2ZKO, G2ZKP, G2ZKQ, G2ZKR, G2ZKS, G2ZKT, G2ZKU, G2ZKV, G2ZKW, G2ZKX, G2ZKY, G2ZKZ, G2ZLA, G2ZLB, G2ZLC, G2ZLD, G2ZLE, G2ZLF, G2ZLG, G2ZLH, G2ZLI, G2ZLJ, G2ZLK, G2ZLL, G2ZLM, G2ZLN, G2ZLO, G2ZLP, G2ZLQ, G2ZLR, G2ZLS, G2ZLT, G2ZLU, G2ZLV, G2ZLW, G2ZLX, G2ZLY, G2ZLZ, G2ZMA, G2ZMB, G2ZMC, G2ZMD, G2ZME, G2ZMF, G2ZMG, G2ZMH, G2ZMI, G2ZMJ, G2ZMK, G2ZML, G2ZMN, G2ZMO, G2ZMP, G2ZMQ, G2ZMR, G2ZMS, G2ZMT, G2ZMU, G2ZMV, G2ZMW, G2ZMX, G2ZMY, G2MZ, G2ZNA, G2ZNB, G2ZNC, G2ZND, G2ZNE, G2ZNF, G2ZNG, G2ZNH, G2ZNI, G2ZNJ, G2ZNK, G2ZNL, G2ZNM, G2ZNO, G2ZNP, G2ZNQ, G2ZNR, G2ZNS, G2ZNT, G2ZNU, G2ZNV, G2ZNW, G2ZNX, G2ZNY, G2NZ, G2ZOA, G2ZOB, G2ZOC, G2ZOD, G2ZOE, G2ZOF, G2ZOG, G2ZOH, G2ZOI, G2ZOJ, G2ZOK, G2ZOL, G2ZOM, G2ZON, G2ZOO, G2ZOP, G2ZOQ, G2ZOR, G2ZOS, G2ZOT, G2ZOU, G2ZOV, G2ZOW, G2ZOX, G2ZOY, G2ZOZ, G2ZPA, G2ZPB, G2ZPC, G2ZPD, G2ZPE, G2ZPF, G2ZPG, G2ZPH, G2ZPI, G2ZPJ, G2ZPK, G2ZPL, G2ZPM, G2ZPN, G2ZPO, G2ZPP, G2ZPQ, G2ZPR, G2ZPS, G2ZPT, G2ZPU, G2ZPV, G2ZPW, G2ZPX, G2ZPY, G2PZ, G2ZQA, G2ZQB, G2ZQC, G2ZQD, G2ZQE, G2ZQF, G2ZQG, G2ZQH, G2ZQI, G2ZQJ, G2ZQK, G2ZQL, G2ZQM, G2ZQN, G2ZQO, G2ZQP, G2ZQQ, G2ZQR, G2ZQS, G2ZQT, G2ZQU, G2ZQV, G2ZQW, G2ZQX, G2ZQY, G2ZQZ, G2ZRA, G2ZRB, G2ZRC, G2ZRD, G2ZRE, G2ZRF, G2ZRG, G2ZRH, G2ZRI, G2ZRJ, G2ZRK, G2ZRL, G2ZRM, G2ZRN, G2ZRO, G2ZRP, G2ZRQ, G2ZRS, G2ZRT, G2ZRU, G2ZRV, G2ZRW, G2ZRX, G2ZRY, G2ZRZ, G2ZSA, G2ZSB, G2ZSC, G2ZSD, G2ZSE, G2ZSF, G2ZSG, G2ZSH, G2ZSI, G2ZSJ, G2ZSK, G2ZSL, G2ZSM, G2ZSN, G2ZSO, G2ZSP, G2ZSQ, G2ZSR, G2ZSS, G2ZST, G2ZSU, G2ZSV, G2ZSW, G2ZSX, G2ZSY, G2ZSZ, G2ZTA, G2ZTB, G2ZTC, G2ZTD, G2ZTE, G2ZTF, G2ZTG

# How to Calculate Grid-Bias Resistor Values

## QUICK-REFERENCE TABLE FOR SELF-BIASING

IN MODERN radio receivers it is customary to operate the tubes under self-biased conditions. That is, the grid bias is obtained from the voltage drop across a suitable resistor inserted in the cathode circuit through which the total cathode current of the tube flows. The difference of potential between the ends of the resistor will be proportional to this current value and to the resistance of the resistor. The direction of current now is such as to make the grid negative with respect to the cathode by an amount equal to the voltage drop in the biasing resistor, provided the grid return is made to the lower end of the resistor.

Since information regarding the proper size and wattage rating of bias resistors is not always available, a set of usual tables has been prepared which indicate the correct value of bias voltage required and total cathode current, under normal operating conditions for those types of tubes most popular in present day receivers.

The curves supplied enable one to readily ascertain the proper wattage

rating of the required resistor if the size is known. If, on the other hand, the required bias voltage and total cathode current be known, the constant resistance curves serve to indicate the proper value of resistance required. The combined use of these tables and curves should aid in saving considerable time and in the elimination of errors while designing circuits or checking over radio receivers.

TABLE NO. 2—SELF-BIASING TUBE DATA—  
6.3 VOLT TYPES

Type	Use	Fil. Amps	Plate Volts	Grid Volts	Screen Volts	Cathode Current MA.	Bias Resistor Ohms
37	Amp.	0.30	90	6.0	—	2.5	2,400
			135	9.0	—	4.1	2,200
			180	13.5	—	4.3	3,100
			250	18.0	—	7.5	2,400
76	Amp.	0.30	250	28.0	—	0.2	140,000
			250	15.5	—	4.2	3,200
			250	20.0	—	0.2	100,000
			250	20.0	—	0.2	100,000
36	RF	0.30	100	1.5	67.5	3.5	430
			135	1.5	67.5	4.5	330
			180	3.0	90.0	4.8	605
			250	3.0	90.0	4.9	615
77	RF	0.30	100	1.5	60.0	2.1	715
			250	3.0	100.0	3.0	1,000
			250	4.0	100.0	0.1	40,000
			250	4.0	100.0	0.1	40,000
666	RF	0.30	250	3.0	100.0	2.5	1,200
			250	4.0	100.0	0.1	60,000
			250	4.0	100.0	0.1	60,000
			250	4.0	100.0	0.1	60,000
39-44	RF	0.30	90	3.0	90.0	7.2	415
			135	3.0	90.0	7.2	415
			180	3.0	90.0	7.2	415
			250	3.0	90.0	7.2	415
78	RF	0.30	90	3.0	90.0	6.0	435
			180	3.0	75.0	5.0	600
			250	3.0	100.0	9.0	335
			250	3.0	125.0	13.5	220
6D6	RF	0.30	250	3.0	100.0	10.2	290
			250	3.0	100.0	8.9	1,000
			135	13.5	135.0	11.4	1,200
			180	18.0	180.0	16.4	1,100
38	Pwr. Amp.	0.30	250	9.0	100.0	8.9	1,000
			135	13.5	135.0	11.4	1,200
			180	18.0	180.0	16.4	1,100
			250	22.5	250.0	25.8	975
41	Pwr. Amp.	0.40	100	7.0	100.0	10.6	670
			135	10.0	135.0	14.7	680
			180	13.5	180.0	21.5	625
			250	18.0	250.0	37.5	480
85	Triode Sect.	0.30	135	10.5	—	3.7	2,800
			180	13.5	—	6.0	2,500
			250	20.0	—	8.0	2,400
			250	18.0	—	0.26	5,000
75	Triode Sect.	0.30	250	1.3	—	0.26	5,000
			250	1.3	—	0.26	5,000
			250	1.3	—	0.26	5,000
			250	1.3	—	0.26	5,000

TABLE NO. 1—SELF-BIASING TUBE DATA—  
2.5 VOLT TYPES

Type	Use	Fil. Amps	Plate Volts	Grid Volts	Screen Volts	Cathode Current MA.	Bias Resistor Ohms
27	Amp.	1.75	90	6.0	—	2.7	2,200
			135	9.0	—	4.5	2,000
			180	13.5	—	4.9	2,700
			250	21.0	—	5.2	4,000
56	Det.	1.00	250	13.5	—	0.2	150,000
			250	20.0	—	5.0	2,700
			250	13.5	—	0.2	100,000
			250	20.0	—	0.2	100,000
45	Amp.	1.50	180	31.5	—	31.0	1,050
			250	50.0	—	34.0	1,450
			275	56.0	—	36.0	1,550
			250	30.0	—	5.2	4,000
2A3	Amp.	2.50	250	45.0	—	60.0	750
			250	62.0	—	80.0	750
			180	3.0	90	5.7	525
			250	3.0	90	5.7	525
24A	RF	1.75	180	3.0	90	5.7	525
			250	3.0	90	5.7	525
			250	5.0	20-45	0.1	50,000
			250	5.0	20-45	0.1	50,000
57	RF	1.00	250	3.0	100	2.5	1,200
			250	4.0	100	0.1	60,000
			250	4.0	100	0.1	60,000
			250	4.0	100	0.1	60,000
35-51	Det.	1.75	180	3.0	90	8.2	340
			250	3.0	90	8.0	375
			250	3.0	90	8.0	375
			250	3.0	90	8.0	375
48	RF	1.00	250	3.0	100	10.2	290
			250	3.0	100	10.2	290
			250	3.0	100	10.2	290
			250	3.0	100	10.2	290
57	Pwr. Amp.	1.50	250	16.5	250	37.0	450
			250	16.5	250	37.0	450
			250	16.5	250	37.0	450
			250	16.5	250	37.0	450
2A5	Pwr. Amp.	1.75	250	16.5	250	40.5	400
			250	16.5	250	40.5	400
			250	16.5	250	40.5	400
			250	16.5	250	40.5	400
55	Triode Sect.	1.00	250	20.0	—	8.0	2,500
			250	20.0	—	8.0	2,500
			250	20.0	—	8.0	2,500
			250	20.0	—	8.0	2,500
2A6	Triode Sect.	0.80	250	1.3	—	0.26	5,000
			250	1.3	—	0.26	5,000
			250	1.3	—	0.26	5,000
			250	1.3	—	0.26	5,000

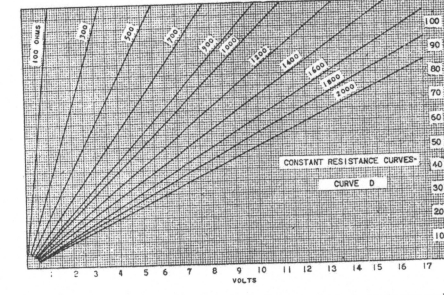
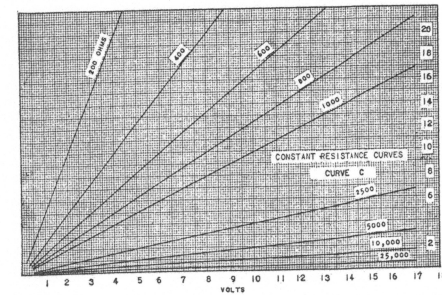
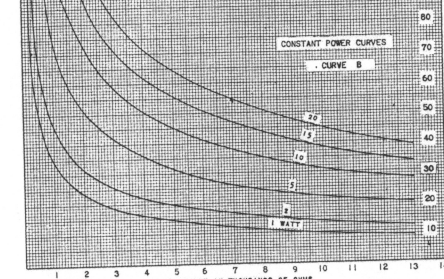
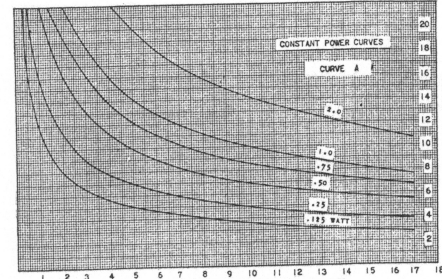

## Exciting the 211 and the 203A

**W4WZ** to excite than a 203A. In his test circuit the load impedance was maintained at 3100 ohms and the input was kept constant, 1000 volts at 175 milliamperes. When the 211 was biased at 100 volts and excited to 122 watts output, the excitation equalled 3.9 watts. Under the same conditions of input, output and load impedance, the 203A required 6.7 watts of grid driving power. The bias for the 203A was 75 volts. The 203A needed 71% more excitation to give the same output. The higher mutual conductance of the 211 (some tube tables to the contrary, notwithstanding) leads us to believe that this might be the case, but W4WZ steps up with the facts.

I note that the bias was slightly less than twice cut-off in each case. It would be interesting to know what would happen if the load resistance were raised and the bias increased to four or five times cut-off. At the same time the plate voltage might be raised to 1500 volts. This new set of conditions would tell us something about "High Efficiency". Of course the excitation required would rise, in greater proportion than the watts output, showing a reduced POWER AMPLIFICATION, but I wonder what would happen to the 1.7 to 1 relation between the excitation of the 203A and the 211.

## DX on 30 Or 60 Megacycles

**THE** present DX record for 60 MC is held in England, where the highest hills are said to be less than 4000 feet high. The next best DX for the ultra-high frequencies is held by the first district group which operates in the New England States. New England has some fair-sized hills, but none to compare with those on the Pacific Coast. Below 1100 feet REAR MAN-SIZED mountains located on the Pacific Coast, and I only show those above 14,000 feet high. There are about fifty more which are above 8,000 feet high. The optical range from a point located at a 14,000 foot altitude is approximately 150 miles, thus two such mountains located 300 miles apart (with no intervening hills) would be within optical range of each other. However, experience shows that 60 MC signals can carry quite a distance beyond the optical range, given favorable conditions, so that a two-way QSO over 400 miles is not impossible. By the same token, a 500 mile QSO on 30 mag-

# Ham Hints

By JAYENAY

**HERE** is a circuit using keying system that CAN'T click. An old telegraph sounder is revamped with a bakelite extension two or three inches long. Instead of contacts, it has a stationary plate of about 1/4 inch square with a thin piece of mica cemented to it, and on the arma-

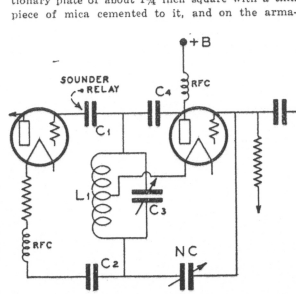

ture another plate of the same size but of aluminum and drilled with several small holes to prevent damping by air. It is shown as C1 in the diagram. There can be no clicks, because no circuit is broken, and because the wave train is tapered instead of abrupt. With the relay up, the preceding stage will be detuned, but it will not get hot because the load is taken off at the same time. A "neu-

## "Gammatron Under Fire"

**40,000 Volts, and Still it Refuses to Turn Blue or Breakdown**  
30,000 to 40,000 volts AC at 60 cycles was impressed between plate and all the other elements tied together and nothing happened except an arc OUTSIDE of the tube from base to cap. While voltages of this order would never be used on the tube in operation, this is a routine test to see that there is no gas left in the tube which might cause it to go soft in operation. Proper tube operation demands that practically all of the gas be eliminated in the evacuating process for long life and efficient operation. Both the 6K35A and the experimental 2S7 Pentode are noted for their "Hardness".

cycles is well within the realm of possibility, even without worrying about a skipping skywave. How about it? Let's wipe the dust off our portable gear and show that 60 MC can REALLY do.

## TABLE OF ALTITUDES

Whitney	California	14,495 feet
Rainier	Washington	14,498 feet
Paildase	California	14,254 feet
Russell	California	14,190 feet
Shasta	California	14,161 feet
Split	California	14,051 feet
Paildase	California	14,049 feet
Langley	California	14,042 feet
Muir	California	14,025 feet
Tyndall	California	14,025 feet
Barnard	California	14,002 feet

## Class B Or Class C Amplifiers?

**THE** desire for high plate efficiency in RF amplifiers has caused many operators to sacrifice other desirable features in order to gain this efficiency. It might be noted that while extreme class C (bias between 3 and 5 times cut-off) allows high plate efficiency to be realized, the power amplification of the stage suffers materially due to the fact that the grid losses increase faster than the power output, as the bias and excitation are raised. Therefore, in later stages it often is desirable to sacrifice some plate efficiency for reasons of AMPLIFICATION.

## Tuned Radio Frequency BCL Sets

**MOST** manufacturers would sneer at the suggestion that their expensive line should include a TRF set, but they will note that Western Electric has a new receiver for broadcast use for centralized radio systems in hotels, etc., and this receiver is NOT a superheterodyne but a TRF. The audio channel of this set is flat, clear up to Ed Wynn and down to Phil Harris. They could have built a super if they wanted to, but they didn't want to cut side bands. I seem to remember that a set called the MB-22 had very few flies on it, too. The principal reason why I would like to see a good TRF set on the market is to enable me to use my NC-5 converter with it. Converters and supers don't get along very well together, because the harmonics of the broadcast oscillator are found every 175 KC throughout the high-frequency bands.

## Impedance Matching

**THE** impedance ratio of an audio transformer is the square of the turns ratio and, inversely, the turns ratio is the square-root of the impedance ratio. Remember that even the best transformer in the world presents the wrong load impedance to the vacuum tube working into it unless the transformer secondary is correctly loaded. Never operate a class B audio stage without the proper load across the secondary of the output transformer, otherwise fireworks will result which may ruin the transformer.

## Electron Coupled Oscillators

**THE** stability of an electron coupled oscillator comes largely from two sources. First, the frequency-determining tank can have a high effective "Q", because there is no resistance coupled into it by the load. Any good oscillator becomes more stable as the output and load is reduced. Second, variations in plate voltage are compensated for by the screen-grid variations because they are tied together through the voltage divider. For these and other reasons, electron coupling deserves wider use. The "Empress of Britain", which has quite extensive ship-to-shore telephone equipment, uses electron-coupled oscillators exclusively, rather than crystals. However, the vessel carries a secondary standard frequency measuring set to check the EC oscillators.

## High Efficiency and Harmonic Generation

**IN** THE last year or so, many ham operators have followed the trend toward high efficiency RF amplifiers. We hear of 5500 volts on the plate of an 852 and 1600 volts on a 210. However, it should be noted that this business of high-voltage-high-efficiency is not all peaches and cream. Aside from the risk of tube failure there is still the problem of harmonic output to consider. We obtain high efficiency by using high DC plate voltage and by biasing the tube to two or three times cut-off. The excitation must be great enough to overcome the bias and drive the tube slightly positive, but the grid is positive for only a very small portion of the cycle. Under these conditions, efficiencies in the neighborhood of 85% are quite possible, which means that the tube is required to dissipate 15% of the DC plate input power, while the other 85% is transferred to the load (antenna or what have you?). However, don't forget that the 85% is not all fundamental. A good part of it consists of second, third and higher harmonics, which are either radiated from the antenna, (with undesired GRM, possibly outside of a ham band), or are trapped and dissipated in a filter. (In which case they help heat the shack). The conditions that are conducive to high efficiency also are ideal for harmonic generation. (High bias and high excitation). High efficiency also demands that we use a very low C tank circuit, and this type of tank circuit represents almost as good a load for the harmonics as it does for the fundamental frequency. (A high C tank by-passes the harmonics). Let us take an example. A 210 class C amplifier was connected to a single-wire feed antenna. A series of selective tank circuits with rectifier type microammeters as indicators were used to estimate the output on the 7010 KC fundamental, and up to the fifth harmonic. Skipping the details of the test, we found that at the highest plate efficiency we were able to obtain, the tube drew 80 MA at 1000 volts. 12 watts of plate dissipation gave us about 68 watts of output (85% eff. approx.). However, we found that this output was divided half on 7010 and the other half of the output consisted of harmonics, up to the fifth. From this we assumed that the fundamental power output was about 34 watts. Then we reduced the plate voltage to 800 volts and cut down the bias and excitation until the tube drew 75 MA, which represented an input of 60 watts. After much work, we estimated that the plate of the tube was dissipating about 15 watts, which gave us 75% as our efficiency, and about 45 watts as our total output (fundamental and harmonics). However, we now found that the power radiated on 7010 KC was eight times the harmonic power, from which we calculated that about 40 watts was being radiated on 7010 KC and about 5 watts on the harmonics. Therefore, with the plate voltage reduced from 1000 to 800, and the efficiency reduced from 85% to 75% we INCREASED our output on 7010 KC from 34 watts to about 40 watts. The error in our calculation was quite high, and the results have been changed to round numbers, but there is no doubt that the 7010 KC output was increased nearly 20% by avoiding extreme efficiency.

If we had used two tubes in push-pull we would have tremendously reduced the amount of even harmonics generated, but we would still have the odd harmonics to contend with, and it should be noted that practically all of the odd harmonics fall outside of the ham bands.



# Matching the Plate Impedance of the '57

By CLAYTON F. BANE

HOW often do we hear someone blaming the manufacturers of vacuum tubes for not bringing out this or that type of a tube? Even if there are a great many possibilities in receiving tubes that have not as yet been recognized by the manufacturers there is another side to the story.

In 1932 the manufacturers presented us with the type 57, an extremely high gain pentode. It was stated that the theoretical amplification factor of this tube was greater than 1500. That was fine, so we used this type of tube to replace our 24A's, and certainly the improvement was marked. The point is simply this—in order to realize even part of the 1500 gain, it is necessary for the plate load impedance to be around 14,000,000 ohms! Such a plate load is readily attainable through the use of resistance coupling, but in order to actually put 200 volts on the plate of the tube it would be necessary to have a plate voltage of 27,000 volts! The absurdity of this is apparent from a practical standpoint. A great many workers have devoted much time to the perplexing problem of matching the plate impedance of the 57 tube. Meissner recently described an amplifier circuit in which gains approximating 600 were realized.\* It remained for Otto Schmitt of Washington University, St. Louis, to point out an extremely practical means for attaining this highly desirable end.\*\*

The desired resistance of the plate circuit is the dynamic, or AC resistance, not the DC resistance. Consequently, what is simpler than to use another 57 to act as the plate load? As Mr. Schmitt points out, the static resistance of a 57 at 200 volts is only in the order of 100,000 ohms, while the dynamic resistance is greater than 10,000,000 ohms. If used in series with the amplifying 57, the DC resistance is low enough to allow the use of plate voltages well within reason.

Quite naturally, if one wishes to realize the full gain, rather elaborate precautions must be taken to prevent instability, oscillation and other bothersome troubles. It is possible, however, to realize gains far and above those now obtained by common coupling methods, with but little difficulty. Let us stop to reflect on the possible uses for such a high-gain amplifier.

The advent of the lower-priced cathode-ray oscillographs has created a definite demand for some such amplifier. The demand is not entirely from those interested in the study of modulation of amateur radiophones, but who is gullible enough to think that the reasonably-priced cathode ray tubes were placed on the market for the sole purpose of offering a cure for the amateur problem of modulation? For cathode ray oscilloscope examination of small currents of any nature, ever, a much more intriguing possibility for the use of this new high-gain system. Why not use a dummy tube in the plate circuit of

our detector circuits? After all, once the signal has acted on the grid to produce a rectified grid current, the tube acts as a pure amplifier and as such it is subject to all of the operating conditions of a separate amplifier. It is true that a grid-leak detector does not operate at the best possible conditions for an amplifier. It operates with substantially zero bias, which does not make for the use of very high plate voltages without disastrous results to the tube, due to correspondingly high plate current. Plate detection would be preferable, but this type of detector must always be preceded by a stage of TRF, a not-too-desirable complication.

Fig. 1 shows the basic amplifier circuit suitable for oscillograph and other purposes. Bias for the amplifier can be obtained by any of the usual means, i.e., cathode resistor or battery bias. If the latter, approximately three

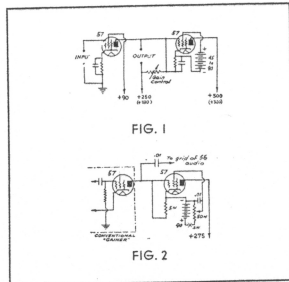

my screen voltage. In the "Gainer" circuit, the regeneration is controlled by varying the screen voltage. If the cathode coil is made of exactly the right proportions, the regeneration will remain reasonably constant over at least an amateur band. If this is so, the screen voltage need not be changed except for critical regeneration adjustments. Obviously, the plate impedance changes with changes in screen voltages, and such a change in plate impedance demands some sort of a variation of the screen voltage of the dummy tube. In practice, the potentiometer controlling the dummy screen voltage was mounted on the panel and used as a sensitivity control. After a signal was tuned-in in the regular procedure, this screen control was adjusted for maximum strength. With this optimum adjustment the rise in signal strength is remarkable. Using only the 56 as an audio stage, wearing the phones was a very uncomfortable business. During our tests with this particular circuit we did not use plate voltages higher than 275 volts, which is a common voltage from most power packs, so that the fine volume experienced is all the more remarkable.

In theory, it is well to remember that the circuit is equivalent to two tubes in series and that a change in screen voltage on one tube will react on the other. For this reason, controlling regeneration by varying the screen voltage of the detector tube is not ideal, even though these changes are compensated for by a change in the dummy screen potential. This is particularly noticeable when the receiver is working on some frequency close to the fundamental frequency of the receiving antenna. In this case, it may be necessary to make considerable increases in screen voltage in order to obtain oscillation. The best cure for this trouble is to cut the antenna to some length where it is not resonant in any of the amateur bands. Of course, controlling regeneration by means of the old-time condenser-to-ground method would leave the screen voltage constant, but the detuning effect of this system leaves much to be desired.

We are working on a circuit at the present time which should solve most of these difficulties.

It is apparently not necessary to go to any particular trouble to shield either the dummy tube or associated leads. No trouble was experienced with feedback in any of our tests. Our main trouble originally when the receiver before we put in an adjustable control for the dummy screen voltage, and in the selection of the bias resistor. The final value, 5,000 ohms, seemed to give the best signal strength. Since all that is required is an additional 57, a 90-volt battery, a resistor and a potentiometer, the addition of this circuit to the regular "GAINER" should be very simple. The only change in the original circuit is to cut out the plate circuit impedance and connect in the load tube in its stead.

We are not attempting to make any extravagant claims for the circuit as shown. It is merely experimental, and it is only reasonable to assume that it will be changed in subsequent experiments. It is the purpose of this paper to present the new circuit to our readers with a few suggestions as to its practical application to our receivers.

If we have a tube capable of a gain of 1500, or greater, and if we get around 100 out of it, surely the possibility of realizing the higher gain should merit much consideration.

my screen voltage. In the "Gainer" circuit, the regeneration is controlled by varying the screen voltage. If the cathode coil is made of exactly the right proportions, the regeneration will remain reasonably constant over at least an amateur band. If this is so, the screen voltage need not be changed except for critical regeneration adjustments. Obviously, the plate impedance changes with changes in screen voltages, and such a change in plate impedance demands some sort of a variation of the screen voltage of the dummy tube. In practice, the potentiometer controlling the dummy screen voltage was mounted on the panel and used as a sensitivity control. After a signal was tuned-in in the regular procedure, this screen control was adjusted for maximum strength. With this optimum adjustment the rise in signal strength is remarkable. Using only the 56 as an audio stage, wearing the phones was a very uncomfortable business. During our tests with this particular circuit we did not use plate voltages higher than 275 volts, which is a common voltage from most power packs, so that the fine volume experienced is all the more remarkable.

In theory, it is well to remember that the circuit is equivalent to two tubes in series and that a change in screen voltage on one tube will react on the other. For this reason, controlling regeneration by varying the screen voltage of the detector tube is not ideal, even though these changes are compensated for by a change in the dummy screen potential. This is particularly noticeable when the receiver is working on some frequency close to the fundamental frequency of the receiving antenna. In this case, it may be necessary to make considerable increases in screen voltage in order to obtain oscillation. The best cure for this trouble is to cut the antenna to some length where it is not resonant in any of the amateur bands. Of course, controlling regeneration by means of the old-time condenser-to-ground method would leave the screen voltage constant, but the detuning effect of this system leaves much to be desired.

We are working on a circuit at the present time which should solve most of these difficulties.

It is apparently not necessary to go to any particular trouble to shield either the dummy tube or associated leads. No trouble was experienced with feedback in any of our tests. Our main trouble originally when the receiver before we put in an adjustable control for the dummy screen voltage, and in the selection of the bias resistor. The final value, 5,000 ohms, seemed to give the best signal strength. Since all that is required is an additional 57, a 90-volt battery, a resistor and a potentiometer, the addition of this circuit to the regular "GAINER" should be very simple. The only change in the original circuit is to cut out the plate circuit impedance and connect in the load tube in its stead.

We are not attempting to make any extravagant claims for the circuit as shown. It is merely experimental, and it is only reasonable to assume that it will be changed in subsequent experiments. It is the purpose of this paper to present the new circuit to our readers with a few suggestions as to its practical application to our receivers.

If we have a tube capable of a gain of 1500, or greater, and if we get around 100 out of it, surely the possibility of realizing the higher gain should merit much consideration.

# Three-Quarters of a Meter or 400 Megacycles

By NORRIS HAWKINS\*

FOR the benefit of those who are going after the Ralph Heintz prize of \$50 for the best complete three-quarters-of-a-meter station (transmitter and receiver), I wish to present some suggestions. The Barkhausen-Kurz and the Gill-Morrill circuits do not seem to be as simple to adjust or as stable as the Kozanowski type of circuit in which the grid is grounded and the plate and cathode circuits are coupled to tuned Lecher wires. Fig. 1 shows a circuit suitable for filament type tubes, such as the WE125A (also known as the N or "peanut" tube), CG1162, WE257A, 99, 20, 800, 825 and last, but by no means least, the 852. (For the high-power boys I suggest a pair of 831's or 571's). Certain of the cathode tubes can be used down on 75 centimeters, but their elements should be cylindrical. The 27, 56 and 37 are fair, and the 89 and 38 have given pretty good results. The 2A5 has been used, but results were very erratic. In the 2A5 the screen was used as the anode and the plate was not used at all! It should be noted that the tuning of the plate circuit determines the frequency, while the cathode tuning merely affects the power output. Note that these circuits are NON-REGENERATIVE. The frequency is a function of the velocity of rotation of an elliptical spiral of electrons. The grid is the positive electrode while the plate is negative with respect to the cathode. The grid mills usually run about 100 times the plate mills. The power output is limited by the filament emission and the ability of the grid to dissipate heat. It is often necessary to run the filaments, or cathodes, of the tubes at from 10% to 50% above their rated voltage to obtain the proper space-charge effect. In view of these facts, don't expect much tube life, because this type of oscillation burns them up in short order. Sometimes it is necessary to "debase" the tubes.

Voice modulation may be applied to the

\* W6AAR-XZ

plate circuit of the push-pull oscillator by adjusting the secondary of an ordinary microphone transformer between the negative terminal of the plate battery and the plate RF choke shown in the diagram. The plate voltage will have to be varied slightly in order

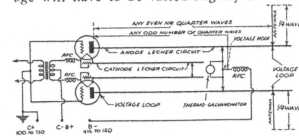

FIG. 1

to obtain good quality, because a very peculiar form of distortion becomes evident if the plate voltage is too high or too low. This same transmitter circuit has been used with good results on a frequency of 2000 megacycles, which corresponds to a wavelength of 15 centimeters. However, the adjustments

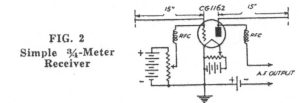

FIG. 2

Simple 3/4-Meter Receiver

to produce oscillation become much more critical and only a few tubes can be made to oscillate at all at this frequency. Voice frequency modulation gives very poor results at these higher frequencies, so the voice frequencies were applied to a 465KC carrier which, in turn, was applied to the 2000 MC carrier. At the receiver, the modulated 465KC

carrier was made available by the ultra-high-frequency detector and then amplified through a conventional 465KC IF amplifier and demodulated again to obtain the voice frequencies. This is much the same system that Westinghouse employs in their experimental 9 centimeter circuits.

With conventional tubes it is impossible to make them oscillate, by means of any form of regenerative feedback, at wavelengths less than about one meter. RCA has been experimenting with some new miniature tubes whose linear dimensions are about 1/10th those of ordinary receiving tubes. These tubes have been used in a TRF receiver at one meter and will oscillate in a regenerative state at wavelengths as short as 40 centimeters. No information is available as to the ability of these tubes to operate as electron orbit oscillators, but they probably should work OK, due to the small spacing between cathode and anode. However, until RCA places these tubes on the market we will have to use conventional types.

Fig. 2 shows a simple receiver for use at 3/4 of a meter. This utilizes the B-K type of oscillation. The frequency is varied by means of the potentiometer across the grid battery. Each time the grid voltage is varied it will be found necessary to readjust the filament potential. The audio output is very low and a stage or so of audio amplification will help the sensitivity materially. Marconi is reported to have used six stages of high gain audio amplification following a detector of this type. Due to the peculiar voltage distribution the noise level is practically nil. There is absolutely no static at these frequencies because nature also has difficulty in generating waves of this order. Note that the grid is positive and the plate negative. Besides the CG 1162 you can use the 99, 20 or N tube. Over short distances a crystal detector can be used at the center of a halfwave antenna. The phones are connected across the crystal detector.

# Automatic Line and Filament Voltage Regulation

By W. E. McNATT, Jr. (W6FEW) and V. W. EMMERT (W6DVV)\*

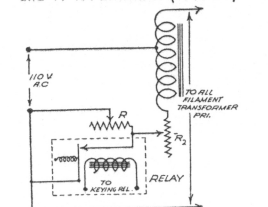

R2 enters into the circuit by manual operation; however when it is once adjusted to compensate for the 110 line voltage variation it is necessary to re-adjust it only when the line voltage variation is greater or less than normal.

W6DVV utilizes an 852 in the final amplifier and usually operates it at 400 watts input. The normal line variation at his "shack" is about 10 volts. He has adjusted the automatic regulator in the following manner:

R1 was set at zero resistance; R2 was adjusted so that the filament voltage on the 852 was normal, or 10 volts. Next, the transmitter was placed in operation and the filament voltage drop on all the tubes was read. Then the key was raised and R2 was re-set so that the filament voltage on the

852 was 10 volts plus an increase equal to the amount by which the filament voltage dropped when the transmitter was on the air. In this case, the resistor, R2, was set so that the filament voltage on the 852 was 10.6 when the transmitter was off the air, i.e., the voltage drop compensated for by the increase of .6 volts over normal. After this was done, the resistor R1 was adjusted so that the filament voltage on the 852 returned to normal (10V). The filament voltage on the 852 then remained constant during the "keying" of the transmitter; this is explained easily. When the relay contacts close, R1, which brought the voltage on the 852 to normal, is shorted out and the voltage rises .6 volt (or whatever value it is set for) BUT the power transformers cause a drop in the line voltage which causes a .6 volt drop on the filament voltage, thereby cancelling the increase, keeping the 852 at normal. When the key is raised, the power transformers, relieved of their load, cause the line voltage to rise so that the filament voltage on the final amplifier stage increases .6 BUT the relay contacts are now open, throwing R1 into the circuit, which offers resistance sufficient to drop the filament voltage .6 so that the filament is kept at normal rating all during operation.

Thus far, the authors have accounted for but one filament voltage regulation. The regulating system is placed in the 110 v.a.c. line to ALL filament transformers, so that when the adjustments are made for one tube, they will, at the same time, compensate for the drop on the remaining tubes in the transmitter.

Mr. Emmert asks that those who incorporate this system in their transmitters write him the results of their work. Further questions will arise in the operation or construction of this circuit will be answered by him.

\* Earl R. Meissner, "Electronics", June, 1933, page 155.  
\*\* Otto H. A. Schmitt, Washington University, St. Louis. "Review of Scientific Instruments", December, 1933, page 681.

# I. R. F. NEWS (Formerly I.T.K.)

The Amateur's Legion of Honor



This department is edited by the President of the International Radio Fraternity, J. Richard Melan (16) radio W6CGM, W6ZGB, KERN. All communications as well as inquiries to the International Radio Fraternity, should be addressed to I.R.F., Secretary-Treasurer, Kenneth M. Isbell, W6AMR-W6BQQ, 5143 So. 6th Ave., Los Angeles, or to the President, J. R. Melan, W6CGM-W6ZGB, 1411-9th St., Bakersfield, California.

Headquarters, either to the Secretary-Treasurer, Kenneth M. Isbell, W6AMR-W6BQQ, 5143 So. 6th Ave., Los Angeles, or to the President, J. R. Melan, W6CGM-W6ZGB, 1411-9th St., Bakersfield, California.

## FLASH!

Inspirational to the amateur world is the special announcement from the headquarters of the International Radio Fraternity that it will offer at the supreme goal of amateur radio achievement an IRF silver trophy to be awarded annually to "the best all-around amateur station in North America" stressing station operating efficiency, public service and emergency communication stop Competition open to all amateurs in North America regardless of fraternal affiliation stop First award will be made for this year stop Contest independent of station power stop Leading amateur radio engineers will act as judges stop Watch for full announcement and details of this the greatest contest in the history of amateur radio!

## New Members

WE EXTEND a genuine welcome to the following stations who have been honored by acceptance into the fraternity and are added to its rapidly increasing ranks: W6BWA, W6CIP, W6AQJ, W6DEA, W6EJA, W6TH, W6HDX, G6CL (Jack Charricosta, Secretary of RSGIB-BERLI), W6VH, W6BIL, W6EAR, W6AJ, W6CFM, W6WX, W6ERM, W6PLM (Bob Parmenter), W6GQ, W6CZT, W6ASK, W6FYW, W6COW, W6DW, W6FKL, W6MCM (Canadian Federal Radio Inspector), K7BOE, K7BND, W6GTY, W6AGB, W6CHL, W6DEC, W6KJ, W6BRG, W6AIO, Z6SA, W6CSV, W6BAA, (Iota, WIMU Radio Assoc.). New member of Iota Rho Sigma (IRF Sorority) is W6BKV of Wharton, Texas.

## Iota Rho Sigma

MISS FLORA CARD of Pomona, Calif., popular Southern California YL operator, has been chosen to lead the IRF Sorority for the coming year as its President. She will handle the affairs of IRS, receive pledges, extend invitations and accept new members into IRS. All feminine radio operators are invited to write to her for details on how to become a sister of IRS.

## So. Calif. Chapter Organized!

MEETING with President Melan and Secretary Isbell in Los Angeles on the night of May 28th, IRF members of Southern California, including Asst. Chief of Communications W6CII, former, and other members of the Chapter, including in its membership the recognized leaders of that large area so densely populated with amateurs. W6CII, former, of Long Beach was chosen Chapter President for the ensuing year, while W6DIO Lloyd Jones of Los Angeles was elected Vice President. W6EK Miss Flora Card won the Secretary-Treasurer's position. Interest ran high as IRF business was discussed as well as amateur problems. Conversation was lively and intensely interesting and one

of the most successful meetings we have ever attended, bearing meritorious evidence of the IRF's plan of choosing its members. Meetings are scheduled monthly to occur on the second day of each month. It was voted to make all present IRF members in So. California members of the Chapter. This includes the following: W6FEW, W6DOB, W6FV, W6CUI, W6HGO, W6EC, W6LN, W6BIF, W6AVJ, W6BO, W6HAG, W6SN, W6FT, W6TDC, W6EEL, W6DQI, W6CIP, W6TH, W6EK, W6VH, W6EAR, W6BYD, W6FT, W6AHJ B7E, W6AJX B7E, W6AAN, W6AKW, W6TDM, W6DYL, W6CII, W6WT, W6AGF, W6ESK, W6CZT, W6QF, W6ERM, W6CFM, W6EKF. About 20 more will be added to this list by the July 2nd meeting as that many Southern California pledges are due to be accepted and the list will include the popular amateur leader W6GWL Ralph McCleery.

## Honor Degrees

THE COVETED Honor Degree awarded by IRF to a member who has performed distinguished or heroic service as a radio operator will be awarded to three men next month. To date only one man has been awarded this Degree, viz.: Ron Martin K1P-AZE for saving the million dollar ship Carnegie and its crew from the path of an approaching typhoon (see story in previous issue of RADIO WEEKLY). Watch for details of these Honor Degree awards.



J. Richard Melan, W6CGM, W6ZGB, President, International Radio Fraternity.

## First South African Member

NONE OTHER than the well-known Z6SA Oliver Walter Reid of Uitenhage, South Africa, has just been accepted into the fraternity. We are glad to have Z6SA with us. His signals have become a familiar sound to our ears and now he is a brother indeed. O. W. Reid has been on the air four years and is operating a CO-FD-PA transmitter with 40 watts input, making use of three aerials, One 66-ft. and two 132-ft. (all voltage fed). He is on 3.5, 7, 14 and 28 MC. usually at 1900-2200 most evenings and sometimes to 2300 GMT. Oliver is age 25, almost a six-footer, and quite a man at 202 lbs., for those of you who wondered what he looks like in person. His occupation is Meter Reader and Switchboard Attendant, for those of you who think that just because he lives in South Africa, H. Brothers Reid says: "I am extremely proud to be honored by an invitation to join the ITRF (now IRF) Fraternity . . . Z6SA." We see by your letter that you read "RADIO" over there, too. Guess everybody anywhere does.

## Traffic Clause:

QUALIFICATION (A) for IRF candidacy reads: "Candidate must have an active amateur station actually handling traffic." While IRF recognizes traffic as the backbone of amateur radio's claim to public service, its membership is not restricted whatsoever to traffic specialists. A better version of this requirement would be that your station must be open to traffic—never refuse a message you can handle expeditiously.

This traffic clause cannot of course apply to foreign amateurs who are prohibited from handling traffic and they are therefore exempt entirely on this score.

W9AIO REPORTS from the World's Fair at Chicago that all IRF roses in putting a fone transmitter on the air at the Hall of Science under the call W9USA, that IRF wants to play a part in modulating the PA system of the Century of Progress. And if that wasn't enough patriotic parachute displays have a penchant for tearing down perfectly good antennas. Let "Hir" of W9AIO tell you about the 20-50 meter fone rig at W9USA. My own rack RP unit accompanied with a modulator which was constructed along identical lines are now down at the Fair. In cooperation with the World's Fair Amateur Radio Council this transmitter is being placed in operation on the open air stage of the theatre in the Hall of Science. It is proposed that a typical radiofone QSO between this outfit and other cooperative amateurs will be a daily feature from 4 to 4:30 CDST at which time both sides of the resultant conversation will be audible to the Fair's guests. It's a great idea but ooch the headaches! I'm afraid we'll have to pump the receiving end in from some QRM-free spot by telephone wires . . . (If we know anything about ham perseverance that fone demonstration is now functioning successfully.—Ed.)

In regard to IRF W9AIO see further "May I say that I feel highly honored in having been pledged to such a worthwhile free-thinking organization. With such men as Buck WZATI, By W6CXW, Les W6BIF and numerous others with whom you are also familiar, being brothers under the IRF, I only hope my good worded letter of thanks when offered an opportunity of affiliation with such a group will be accepted.—Royal J. Higgins W9AIO" (He was awarded with the Degree of Lightning Jerker.)

## Contests

THE CHIEF OF COMMUNICATIONS plans on having a QSO party on the second week-end of each month for all IRF members with a prize to the winner each month. During these QSO parties the member-stations call and answer "CQ-IRF" calls. These contests have always been greatly enjoyed in the past, it strengthens the fraternity by reason of the members becoming better acquainted on the air and every contact with another IRF member insures a 100% QSO. A big Five-Ten Meter Summer Contest is scheduled to begin next month and will last through the summer months. This will particularly encourage summer portable activity as well as radio advancement on these ultra high frequencies. Competent judges will be chosen who are recognized authorities on five and ten meter transmission and they will choose the man who has done the best work during this summer period. As is the IRF custom, a good prize to the winner. Some excellent plan notes, test sets and fone stunts are being lined up and will be announced soon. It is the desire of IRF that all contests will serve some very useful purpose and not just clutter up the air with a lot of signals. With this in mind traffic contests are being planned that will have their goal the speeding up of traffic handling with maintenance of accuracy and reliability.

## MRL Coils for the Gainer Receiver

Also Coils for Clinton Osborne's "Versatile Receiver"

Try a set of "MRL" celluloid-form ultra-efficient coils for your GAINER or any other s.w. receiver . . . and then LISTEN to the difference. Celluloid is an excellent short-wave coil form material. Smoother regeneration, more volume, more selectivity when you use MRL coils. Beautiful in appearance, unexcelled in performance. And the price is only \$1.50 list for a box of four coils, 20 to 200 meters. When ordering be sure to specify if "GAINER" or ordinary s.w. circuit is to be used. Our "GAINER" coils have the correct number of turns for the cathode coil.

**New - New - New - New**  
Just out . . . A brand new Transmitting Coil Form by MRL WOUND ON CELLULOSE FORM, Low Loss, Real Efficiency. Try one and be convinced. Wound with No. 14 enameled wire. Forms are made in a single piece with soldering lugs. Can be mounted on stand-off insulators. Ideal for quick band changing. 20, 40, 80 meters. ONLY \$1.00 each.

—Send stamps for latest issue of "MRL OSCILLATOR."

Modern Radio Laboratories  
151-F Liberty Street, San Francisco, Calif.



## W3BBB—Reading, Pennsylvania

### As Related by the Op to W6WB

STATION W3BBB first saw light on March 10, 1930. At that time it consisted of one lone 210 tube in a Hartley circuit with approximately 75 watts on its plate, most of which was dissipated in heat. Time passed, but as far as DX is concerned the results were nil. Many antennas were tried but always NO. Another 210 was added but it did not seem to help much. Finally, disgusted with trying to work DX, the op decided to try fone. A crystal was duly purchased and the station went on the air with about five watts in the antenna. However, due to the fact that the evil DX bug had bitten firmly into the deeper tissues, fone soon lost its kick and an 852 was put on

Many hams complain that with resistor bias they have no protection from failure of preceding stages, but here a simple magnetic breaker provides ample safety for the power supply and tubes. The best feature of resistor bias is that it adjusts itself to the available excitation.

I have noticed that many hams have quite a bit of trouble with antennas. I have used many antennas at this location and all but a few seemed to work very well. The first day the single-wire Hertz was up, five continents were worked and all but Europe gave reports of RR. No trouble has been experienced in raising all that is heard here. However, noise has been a large factor in preventing a lot of DX from coming through.

live in the center of the town continually complain of the high noise level. The DX success of the station might be attributed to the slightly higher level, but this is not probable as it is not high enough to make much difference. The local police radio system on 2442 KC has found this section of the city very favorable for reception. The patrol cars can get Portland, Ore., R9 on their car radios only in this section and a few streets away have trouble in receiving local stations. As W3BD1 puts it, "it's just one of those things."

The accumulated records of DX at this station are nothing particularly astounding. There are many stations that can beat what I have done. The number of countries worked is between 60 and 70, but I will not attempt to give the exact number on account of the controversy that is raging at the present moment concerning counting of countries. Some of the better DX is as follows: VK, ZL, K6, K7, K5, K4, J, AU, PY, CE, LU, CX, HK, CA, HK, HP, NN, VP, 1, 2, 4, 5, 6, 8, 9, ZS, ZT, SU, FM, CN, I, G, F, HAF, OK, TS, YM, D, ON, PA, GI, EI, LA, OH, SM, EA, FPEAR (now EA8), OE, EU, OZ, Etc. When a better system of counting our countries is arrived at we may count them on the same basis. As far as DX contests are concerned, all I ever do during them is to get on a few times to see if anything unusual is coming through and work it if possible. I derive the most fun out of trying to hear and work stations in countries that are the hardest to work, such as VS, VU, etc. If any of those stations ever came through here on the East Coast, I think there would be a panic, HI.

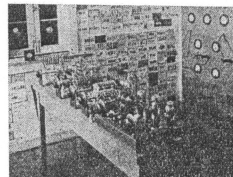

No Rack-and-Panels here. W3BBB likes to see what's going on in each stage. His station has worked between 60 and 70 countries.

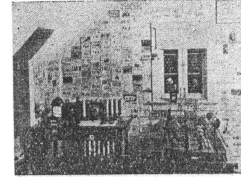

7 MC. in a Hartley for more attempts at DX. Almost the first QSO with this rig was a W6 and never having worked the west coast before, we were very much elated. The next morning, the first station that came back to our call was VK2PX. From that time the station has been used for nothing more than DX and ratcheting. Traffic is accepted when possible but the thrill of DX has never quite left.

At this point we tore down the selfshaded rig and put in CC with about 400 watts on the 852 final. Fairly good results were obtained with this rig and all continents were worked in 1932, the QSO with Asia being the great thrill. In the fall of 1932 the article on high efficiency amplifiers was published by Mr. Perrine, W6CUH. The transmitter was again rebuilt "a la W6CUH." It now consists of a 59 triode oscillator, a 46 doubler used only on 14 MC., a 210 neutralized buffer, an 852 second buffer and a pair of 852's in the final stage in PP with anywhere from 750 to 1000 watts input. The antenna is a single-wire-fed Hertz, 66 feet long. Much experimentation had to be done before the rig reached its present form, but now that it is in a fairly permanent state I hope that the art will not advance too rapidly so that the rig will be antiquated in a short time. The mechanical arrangement of the transmitter proper is permanent but the power supply itself is only temporary and is going to be rebuilt in a short time. This power supply uses three rectified AC units, 400 volts for the oscillator and doubler, 750 volts for the first buffer, and a bridge rectified supply giving up to 4000 volts. Resistor bias is used throughout with no trouble.

Here in Reading we are continually battling with trolley cars, street lights and the like. There are also power leaks that aren't strong enough to come through on the broadcast band but are loud enough on 14 MC to wash out all the weaker DX signals. This type of interference is much more annoying than an R9 blast from a big leak as it doesn't annoy the BCL's receivers and therefore rarely corrects itself. As I see it, the only hard part about working DX is the hearing of it, not the working or raising of it. To return to antennas, I have found that if the radiator (flat top) runs in a North-South direction and slants toward the South, the best results are obtained. This arrangement seems to give most of the radiation toward the East, West, and South and as most of the DX is in these directions, that is what we are after. Don't be misled by this data, however, as I have found that signals from the East Coast to Japan travel over the North Pole or Alaska and therefore would necessitate a radiator toward the North.

A few words about the location of the station might not be amiss. We are located on the West side of Mt. Penn, about 750 feet above sea level. A funny thing about this location is the fact that Mt. Penn continues to rise for another 500 feet to the East of us and this might indicate that it is hard to get out toward the East. Contrary to this fact, Europe has been the easiest continent of them all to work, with many R9 reports from that region. Several QSO's with VK have been had in the late afternoon, too, showing that the signals seem to go all the way around. Everything considered, however, the location is not so bad. Hams that

I would like to propound a few of my theories concerning the working of DX. I believe that the longer the antenna used for receiving, the more stuff will be heard. I use a wire about 250 feet long which seems to give fair results. If it were possible I would put up as much wire in a straight line. The receiver at present is an SW3 but an SS super is in the process of construction and, of course, will be a big improvement over the simple regenerative set. An electron-coupled frequency-monitor is in use to supplement the station equipment. Another thing (Continued on page 31)









Of all strange words from tongue or pen, the strangest are those of the wireless men. The Interceptor is ever on the alert to chronicle the chatter of the commercial operator's static room, to pick up the gossip of the amateurs, to relate the weird expressions of the BCL and to bring you, from time to time, the "log" of the brass-pounder so that you may know how the other radio fellows work and play. This month the Interceptor submits two letters from Larry who tells what happened aboard the ship on which his first trip as a commercial op was made.

Nr. 23, Check \$3.98, Radio, SS, Lake Discomfort, 278 Pm, Date, George Hasenpeffer, 218 River Street, Hoboken.

Dear Gimmick I got aboard this packet all KO and sailed at noon (stop) I had an accident right away though (stop) The antenna blew down first day out (stop) I got up the mast to fix it and I fell down (stop) I didnt get hurt though (stop) I had on my light fall coat (stop)

The first thing the steward asked me how I liked my room (stop) I told him the room was KO but shiver my spanker boom if the bed aint the bunk (stop)

Just yesterday the ship doctor came around and says are you sick (stop) No I says just a little cold (stop) Great wonder you aint got a cold all the time says he (stop) Why I says (stop) Well he says just look how much of you is turned under for feet on the cold deck (stop)

On the trip down the captain came into the radio room and he says whats all this rumpus (stop) A passenger says why I gave this operator a message to send (stop) Well says the skipper did he send it (stop) No says the passenger I wouldnt let him (stop) Just as soon as I handed it to him he started reading it the fresh time (stop)

On Friday a passenger came into the radio cabin and he says aint you got no loudspeaker (stop) Yes I says but she is visiting friends in Portland this week (stop) Why he says I thought you called your wife your meatburner (stop) Well I says loudspeaker or meatburner little diff (stop) Theres a lot of frying and sizzling connected with either of them (stop) They keeps you awake nights and take lots of upkeep (stop)

Professor Fleisch Esseh a passenger for the Sandwich Islands came into the radio room to talk radio (stop) Do you think the ether is a myth (stop) No I says I think its a mythery or a anaesthetic (stop) Why says he (stop) Well I says look at all the broadcast announcers that put you to sleep (stop)

Yesterday afternoon a Scotchman came into the radio room at noon and wanted to send a nite-letter (stop) He came doo ut I says (stop) Hoor mon hoot he says (stop) Hold yer hand out I says as you round the corner (stop) Ye canna park here and blow yer horn (stop)

Well Gimmick I run out of cigars again this trip (stop) Everybody that comes into the radio room helps themselves (stop) They take out the innards of the VTS if they want sealed (stop) I was just lightning my last El Ropo when the mates false teeth blew off the shelf in the pilot house and bit the smoke in two (stop)

Just then the Chief Engineer came along and says he whats the matter Sparks (stop) Look at your feet I says (stop) Whats the matter with them he says (stop) Well they aint mates I says (stop)

Well a lady came into the radio cabin today and she says can I send a radio to my sheik (stop) Well I says lady we dont communicate with Arabia (stop) Wont a substitute do I asks (stop) I aint so very busy after the weather report comes in (stop) QRT she says (stop) Save your batteries your arc is bubbling she says (stop) But lady I says Im just a poor lonesome radio-operator and theres only one thing that will warm my barren heart (stop) Try a hotwater bottle she says and I takes out my revenge on a poor lumber scow up down the coast who is testing his squeak box (stop)

Some passenger called up on the ship phone yesterday (stop) Is this the radio he says I want to send a message and Im down below (stop) How far down are you I asks (stop) Oh to hell and gone down here (stop) Well I says you dont want to send a radio you need ice—call the bell hop I says (stop)

Well OM we are getting into port now and I gotta get up town to the office (stop) C U next trip (stop) 75 (stop)

(Sig) Larry

Nr. 163, Check \$9.98, Radio SS, Lake Discomfort, Filed 8:87 Am, Date, George Hasenpeffer, 218 River Street, Hoboken.

Dear Gimmick (stop) Well OM we had a fine trip this time (stop) We tuned in on them Hale-Fellows-Well-Met at Frisco and they sure had a swell musical number OM (stop) Some swell soprano sung that old song quote refrain from smoking unquote (stop)

Well OM my swell stewardess friend quote Blonde Preferred unquote come up to the shack when we sailed and brought her little brother along (stop) He cant sleep account of the fog whistle she says (stop) Well thats nothing I says when I was working night trick up in the fog belt on the coast my little cousin was twelve years old before he ever seen the sun (stop) And I says the skipper let me take him out on a coastwise ship so he could see it (stop) Oh switch to your batteries she says your breaker kicked out (stop)

A passenger put his head in the radio shack and he says dont them sea gulls get shocked up on the antenna not any at all he says (stop) No I says it dont ever shock anything that way except I says one time when I was using the hot compensation loop on CW and the juice jumped through three of my finger nails well I says that time every body within a thousand miles got shocked (stop) My land he says (stop) You must run a farm I says and starts on scattering a few quote Love and Kisses unquote gags for the customers (stop)

I forgot to tell you OM we got a swell tone color amplifier now (stop) I guess its KO because when we first tuned in with it we all seen red (stop) I guess they put in them peaked transformers (stop) They sure look peaked and scrawny-like OM (stop) Its home made though and its tone color is a picture no artist can paint OM (stop) They says the grid leak changes tone color OM but ours dont change any at all it just stays black OM (stop)

Blonde Preferred says I brought up little brother to see your set (stop) Hes a BCL she says and he can listen in so fast that all

the other BCL boys in the neighborhood cant copy him (stop) Youre a dear Preferred I says (stop) Yeah she says thats what all the radio men says (stop) Dont you ever set foot in this radio shack again I says Preferred you know I thought that we—well you know I been saving my money and Ive always wanted a home—just a little home maybe out on an island some place—(stop) Gee she says kindly and I know a swell place too she says that youd like (stop) Yes go on I says (stop) Yeah she says you might go up there and she says Staten Island sound like Snug Harbor fine (stop) Well old man you could have knocked me over with a capstan bar (stop) And now here I am eating out my heart and trying to drown my sorrier in putting RF in front of a regenerative set though goodness knows that dont detract from it OM (stop) Preferred is like the QRM over in the British Channel OM you cant get a word in edgewise and make it stick OM (stop)

Say OM last trip Honk got a BCL receiver which he said some Scotchman made (stop) Theres covers made for the voltmeters so you can cover them up when you aint looking at them (stop) And it has a clock on the panel OM (stop) The directions are in the Scotch language OM and they say to be careful to stop the clock every night and start it in the morning (stop) it sure stops wear and tear Honk says (stop)

Well OM I see in a British paper that some Englishman blames a late magnetic storm on a small sun spots (stop) Since the sun is about nine million miles away OM I hear the quote Institute of Radio Engineers unquote decide after a stormy meeting that they would not bother doing anything about it OM (stop)

Say OM the third says hes going to land on his own watch now and thats all there is to it (stop) Well I says the company furnishes a nice swivel chair and cushion and I says why not put it to good use (stop) Ah he says you dont get me (stop) Well I says if the RI hears you sending them CQ-S every three minutes why he will get you OM (stop) Oh I aint doing nothing he says (stop) Yeah I says thats just the trouble and I says you better stay off the air when you aint got nothing to do on it (stop) Bah he says (stop) The third is a good skate OM but he is flighty-like (stop) He was in the air service once I guess (stop) Signal Corpse I ever see (stop)

Well more next trip OM (stop) Send me that new 120 volt filament hook-up you used har har (stop) 75

(Sig) Larry.

**NEW VELOCITY MIKE**

Amperite Model RA. Easiest way to improve any public address system. Remarkably life-like. Flat response over entire audible range. Directional quality eliminates acoustical feedback. Write for Bulletin RA.

Assembled, list price \$25. Kit, \$15.

---

**NEW CONDENSER MIKE**

Professional in quality. Life-like. Special diaphragm stretched so that resonant point is far above audible range. Write for Bulletin C.

Assembled, list price \$10. Kit, \$8.

---

**NEW AMPERITE for 2V Tube**

A new series of Amperites. Automatically regulates filament of tubes. Enables 2 volt set to operate on air cell, storage battery, dry cell, etc. Write for Bulletin 2V.

AMPERITE Corporation 561 BROADWAY NEW YORK

## One-Tube 5-Meter Transceiver

(Continued from page 7)

This circuit uses a type 19 two-volt filament tube as a push-pull oscillator and detector. As an oscillator or transmitter, grid circuit modulation is used because of the extreme simplicity. The microphone, an ordinary single button telephone transmitter, is in the negative B battery lead and the voltage drop and variation of voltage is used as grid bias. There is a steady voltage drop across the resistance of the microphone and when it is spoken into. The variation of resistance causes a variable grid bias on the oscillator. The 19 tube is a "high mu", or high amplification type of tube and a fixed bias type

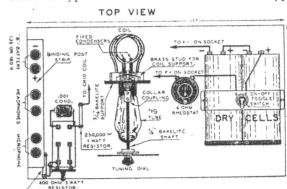

Looking Down on the Assembled Transceiver

rather than a grid-leak oscillator circuit is used in order to simplify the modulation circuit. This tube is really two "high mu" triode tubes in one envelope. It can readily be used in a push-pull oscillator circuit.

Unity coupling is used because the set must stay on the same frequency in both transmit and receive positions. Tuned grid-tuned plate, or TNT oscillator circuits require a compensator on one of the switch positions, which adds complication to the circuit. Unity coupling is obtained by running the grid coil inside of the plate coil. Two turns are used in order to conserve space and coil external field, and also to give short leads to the bypass condensers C2 and C3.

In the receive position, the microphone is cut out of the negative B battery lead and a pair of telephone receivers cut in. The grid return is also switched-over to a quarter megohm grid leak in order to obtain blocking-grid super-regeneration. The grid leak returns to 4-B in order to give better results, as previously mentioned.

Unless one has had considerable experience with five meter circuits, it is suggested that the exact layout shown in the picture of the "breadboard" set and circuit of Fig. 4 be followed. Sometimes the misplacement of a single lead or condenser by as little as a half inch will ruin the operation of a five meter set. A straight piece of wire one inch long has a very appreciable inductance and capacitance on these ultra-high frequencies.

## The Much-Maligned Linear Amplifier

(Continued from page 12)

tank condenser is also desirable, as an RF stage has a tendency to "blow up" even though perfectly neutralized when the bias is dropped below cut-off and the excitation is removed, which is just what happens when the negative modulation peaks hit 100 per cent, the correct bias for a linear being slightly below cut-off. The split stator condenser will usually prevent such a thing from happening. If the linear stage is not absolutely stable without excitation even though a split-stator tank condenser is used, the linear stage is not sufficiently isolated from the low-powered stages.

Because their dynamic characteristic shows better linearity, and also for the same rea-

The oscillator coil consists of a small coil of 7/8-in. or 1/4-in. soft copper tubing with a well-insulated piece of rubber or cambric covered wire woven through it for the grid coil. The copper tubing coil consists of 1 1/2 turns, two inches inside diameter, with a center-tap on both coils. The grid coil center-tap can most easily be made by cutting a small slot (about 1/2-in. long) in the copper tubing, at the center of this plate coil. The grid coil can be threaded through the tubing in two sections with the center connection soldered together in a small "pig-tail" connection about 1/4-in. clear of the copper tube center opening. The ends of the plate coil tubing can be fastened into small brass end blocks or soldered directly to the two plate terminals

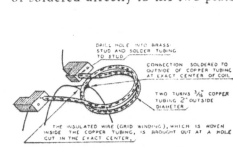

Showing How to Make the Plate Coil, with Grid Winding Inside of Plate Coil

conveniently coupled to the set by means of a clip on the copper tube inductance. This clip should be near the center tap, but as far away from it as possible to still get the super-regenerative hiss over the tuning dial range. Usually the clip will be not over an inch along the inductance from the center-tap. Any wire can be used as an aerial, even values up to several hundred feet in length. For most local work a four-foot wire or rod can be used, connected to the oscillator by means of the clip mentioned. For better results a wire 12 feet long is recommended; it gives a quarter-plus-half-wave antenna. The 4-foot section acts as a quarter-wave antenna with the set and batteries acting as a ground or counterpoise. Probably an aluminum plate

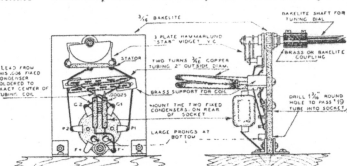

Rear and Side Views of the RF Portion—Note Short Connections

on the 19 tube socket. The ends of this coil extend down about an inch, or slightly less, in order to keep the coil center-taps clear of the other tube socket terminals. The two inside, or grid leads cross over to opposite socket grid terminals. The tuning condenser mounts besides the tube socket and thus the leads to the condenser are only an inch long. A bakelite extension to the dial shaft is necessary in order to eliminate hand capacity effects.

For convenience the two B battery leads, microphone and headset connector are brought out to six binding posts. Either 135 or 180 volts of B batteries or a small B eliminator may be used. The plate current is from 5 to 50 milliamperes on transmit, and about 5 on the receive position. Most headsets work better when the 5 MA plate current through them; a reversal of the phone tips often increases sensitivity.

The transmitter should illuminate a 6-volt dial light when the latter is coupled to the oscillator coil by means of a two-inch turn of wire soldered to the lamp terminals. A single turn with lamp is a very useful oscillation indicator for any transmitter, since it is fairly sensitive. Modulation can be roughly checked by this same means.

The receiver should give a hissing sound when it is functioning properly. A good five meter signal always reduces or eliminates the background hiss. The antenna can be most

son that makes them desirable in Class A Prime audio circuits (grid need not be swung so far into a positive region, low or medium mu tubes should be used in preference to higher mu tubes in this linear stage). However, a pair of 203A's were used with good success at the writer's station.

A "STABILIZING RESISTOR," noninductive and of such value that it allows the proper amount of voltage excitation to the grids of the linear stage when giving the Class C stage the proper load to work into, should be shunted across the grid coil of the linear. Or, a somewhat lower resistance may be used and clipped across only part of the coil, thus providing an adjustment. When the correct amount of loading and coupling are found, the Class C stage will be drawing the right number of

about the size of the breadboard and underneath it should aid in this effect, if it is connected to one of the 19 tube filament terminals by means of a short lead.

Trouble shooting the set is fairly simple. For the newcomer or beginner, the polarity and voltages of the A and B batteries should be checked. The values of the resistors and mica by-pass condensers are important. The filament rheostat should be set so as to give 2 volts across the 19 tube filaments. Good soldered joints should be made throughout and all RF leads made as short and direct as possible. The 19 tube should be a good one and a check can be made by inserting a milliammeter in series with the B battery. It should read from 50 to 60 milliamperes when transmitting, and drop to about 10 or 15 when not oscillating, such as when touching a plate or grid terminal with the antenna or one's finger. For receiving, the plate current should read about 5 milliamperes.

If it is possible to obtain a high-level single button mike of about 200 ohms resistance, the 600 ohm plate resistor R2 can be eliminated and more power output obtained without excessive plate current. This resistor holds the plate voltage to about 100 to 120 volts, since the mike used had only about 20 ohms resistance with rather low grid bias voltage results. The set has worked very satisfactorily over distances of ten miles, without either location being more than 50 feet above ground.

mils, and the grids of the linear will be receiving just the right amount of excitation. A mazda lamp is suitable for the resistor. It is of course unnecessary (we hope) to state that the Class C stage MUST BE RUNNING CLASS C. That means plenty of bias and excitation, good neutralization, and plenty of filament emission to supply plate current on the modulation peaks.

The bias for the linear should be such that a few mils of plate current flow with no excitation to the linear. AT THE PLATE VOLTAGE AT WHICH THE LINEAR WILL OPERATE. Thus, with a power supply of poor regulation (which is perfectly OK after the stage is once working), finding the correct bias is quite a problem, because when the mils drop to around zero, the plate voltage builds up, requiring more bias to

(Continued on page 31)

## SENSATIONAL PRICE REDUCTIONS!

### Sargent 9-33

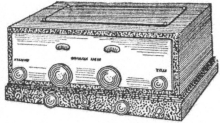

The receiver that has heard amateur and short wave broadcast signals from all continents—that works duplex on the 40 meter band with Africa, South America and Manila—that has heard all U. S. Districts and Hawaii on the 160 meter phone band. Hailed by experienced amateurs and experts as the best amateur and short wave receiver ever built. Has all-wave band spread, separate beat oscillator, push-pull 2AS audio, self contained power pack. Extremely efficient 15 to 200 meters, average efficiency on 200-550 meter broadcast band. A RADIO MAN'S RADIO SET. Sold regularly, all season, for \$69.50 unequipped, or \$87.50 complete. NEW PRICE—

COMPLETE WITH TUBES  
AND 8" DYNAMIC SPEAKER **\$4950**

The Supply Is Limited—  
Act NOW If You Want One

To acquaint you with our new FACTORY-DIRECT sales department which we are now opening in enlarged quarters, we have set aside a limited number of Sargent 9-33 Receivers to be sold direct, fully equipped, for \$49.50. We cannot guarantee this price after this supply is gone. This value in an amateur receiver has never been equaled. Every set is thoroughly tested and well packed to withstand shipment to any part of the U. S. A. We do not promise delivery after July 15th at this price. ACT NOW and get a receiver that you will be proud to own for years.  
EVERY SET NEW AND GUARANTEED  
Wire or Air Mail Your Order and Deposit

Order Direct From Us to Get This Price  
New Factory-Direct Policy  
Makes This Amazing Value Possible

WRITE FOR NEW PRICES ON  
2 AND 3 TUBE KITS

The Best Radio Values Ever Offered

**E. M. SARGENT CO.**  
2085 BROADWAY OAKLAND, CALIF.

NOTICE! You can get the next 4 issues of  
"RADIO" for only \$1.00. Subscribe now.

## Ready...

### The 2nd Edition of KRUSE'S Radiophone Guide

(Thoroughly revised, not just a new cover)

—Doubled in size  
—Newer than ever  
—5 meter information  
—Antenna information  
—Batcher's Radiographs  
—No end of trouble-shooting information  
—Not much theory, lots of practice.  
If you **HAVE** a radiophone you need the **GUIDE**.

If you **want** a radiophone you need the **GUIDE**.

At your dealer's, or sent postpaid  
for 50c (Canada 75c).

**ROBERT S. KRUSE**  
GUILFORD, CONNECTICUT  
(P.S. The first edition sold out in 90 days.)

### "WHO'S WHO IN AMATEUR RADIO"

An absolutely indispensable book for the active ham. Contains 170 pages of photos, personal and station writeups of over 3000 amateurs. Your shack is incomplete without a copy. Sent for one dollar, postpaid.

RADIO AMATEUR PUBLISHERS, 1107 Bway., New York

## Behind the POLYMET Trade Mark



This midjet size mica condenser is extremely popular where space limitation is a factor—Polymet fabricates seven different types of mica condensers from .000005 mfd to .03 mfd capacities.



### Hi-Frequency Condensers

These condensers are designed to eliminate the common faults of ordinary condensers such as poor power factor and inductance. Because of their low loss characteristics Polymet's new Hi-frequency line is particularly recommended for use in short wave receivers.

## POLYMET PRODUCTS

Are recognized by many of the leading manufacturers in both the radio and electrical industries for that HIGH QUALITY so essential to dependability. THEIR ENGINEERS DO NOT GUESS—THEY KNOW. The successful service man, experimenter, or amateur does not guess, he knows that the use of POLYMET products in his work is his GUARANTEE OF SATISFACTION.

### Polymet Condensers

ELECTROLYTIC—Wet and Dry Types

PAPER—Tubular and all can types

MICA—All Types, Midjet Sides with lugs & leads

TRANSMITTING OIL CONDENSERS

CONDENSER for all PURPOSES



POLYMET STANDARD WET  
ELECTROLYTIC

This type wet electrolytic condenser type is most popularly used throughout the entire world because of its established reputation for quality and durability.

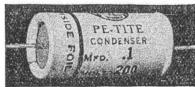

PETITE CONDENSER

A new POLYMET Tubular paper condenser in greatly increasing demand by radio manufacturers. Its compactness and low cost offset many economies in radio.



POLYMET DRY ELECTROLYTIC  
CONDENSERS

Exceptionally popular in the leading AC-DC receiving sets. Furnished in many combination dual and triple units. Supplied in either cardboard or metal containers.

We Also Manufacture TRANSFORMERS and WIRE WOUND RESISTORS

**Polymet Manufacturing Corporation**  
831 E. 134th ST. NEW YORK, N. Y., U. S. A.

Write for New 1934 Catalog

### The Much-Aligned Linear Amplifier

(Continued from page 29)

produce cut-off. However, if one has a high-resistance voltmeter, the procedure is greatly simplified, as the bias can be dropped in proportion to the plate voltage after cut-off is found and the stage put in operation. It should be remembered that it takes but a little rectified grid current to charge a "45-volt" block of B battery up to 60 volts. For that reason, it is wise to wait until the batteries are charged up before making the final adjustments. And then, if the rig is not used for some time, the batteries are back down to 50 again, so it is really best to use a C substitute (B eliminator with very heavy bleeder properly bypassed).

So for a high-powered, grid-excitation-modulated phone, observe the following:

1. The plate voltage should be as high as the gas content and insulation of the tube will allow, if available.
2. Link coupling should be used to the linear stage.
3. A split-stator tank condenser should be used for the linear tank.
4. Low or medium mu tubes should be used in the linear stage.
5. A low resistance source of bias should be used (heavily bypassed if not batteries).
6. The bias should be such that if the excitation were removed and the plate voltage were to remain constant, the tubes in the linear would draw a few mils of plate current.
7. A stabilizing resistor should be used to swamp out the variable load offered by the grids of the linear under modulation.

### Globe Girdlers

(Continued from page 25)

that always "gripes" me is the useless calling of "CQ DX." The fellows would work much more DX if they would listen more and not waste so much time calling CQ.

I believe this covers all the activities of W3BBB up to date. I always enjoy a good "cloth chew" with anyone, regardless of his location. Buck (W5ATF) and myself often have very FB chews and I must say that he certainly can push that old bug into a frenzy.

The pictures of the transmitter and a general view of the station are self-explanatory.

### Fixed "T" Type Attenuators

FOR fixed attenuation of low voltage signal lines or for matching in signal level two or more input circuits to a Public Address System these units are very convenient. Standard values are 5, 10 and 15 decibel attenuation in either 200 or 500 ohm impedance. These attenuation pads are made by connecting 3 wire wound resistors of proper value in "T" circuit. They are mounted in a bakelite case which is approximately two inches in diameter and one inch in height.  
Maker—Electrad, Inc., 476 Varick Street, New York City.

### High Frequency 2 Volt Pentagrid Detector-Oscillator Coming

ONE of the larger tube manufacturers has completed tests on a high frequency edition of the 1A6 and it is expected that it will be in production shortly. This should interest those planning the construction of portable supers and it may be that the new tube will be useful as a combined autodyne detector and audio amplifier. In this event, the constructors of simple high frequency receivers may be able to duplicate the performance possible with tubes such as the 5T and 6C6 series. We now wonder when some enterprising manufacturer will get around to designing a low-C RF pentode with a two-volt 60 cycle filament. The 84 has not been particularly satisfactory at frequencies above 5000 KC, and the 32 also leaves something to be desired as a short wave tube.

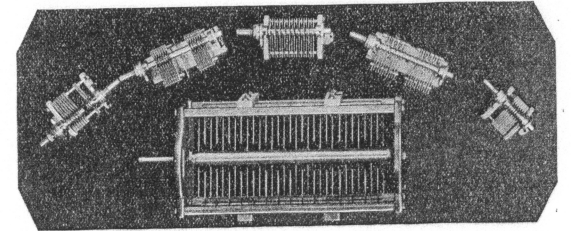

## "HAMMARLUND" means Quality!

SOMETIMES, even the most careful amateur is tempted to "economize" on his equipment—and often to his sorrow. For experience has definitely proved that results in radio cannot be superior to the parts used in construction.

Since the early pioneer days, "HAMMARLUND" has meant QUALITY! But it has never meant high price.

Bear that in mind when next you need condensers, coils, transformers, chokes, shields and sockets.

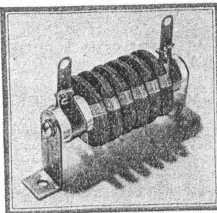

At the right are illustrated two exceptional new Hammarlund Chokes. A midjet R.F. Choke, wound on Isolantite core. Inductance 2.1 mh. D. C. resistance .35 ohms. Distributed capacity 1 mmf.

And the ONLY Transmitter Choke which has more than 500,000 ohms of impedance at the 20, 40, 80 and 160 meter amateur bands. Isolantite core. Inductance 2.5 mh. D. C. resistance 8 ohms. Distributed capacity less than 1.5 mmf.

### Mail Coupon for Details

HAMMARLUND MANUFACTURING CO.  
424-428 W. 33rd St. New York

Check here for General Catalog "34" of condensers and other precision radio equipment. Check here for booklet describing the famous COMET "PRO" 8 to 550 meter Superheterodyne Receiver.

Name .....  
Address .....  
R-7

## WIRES and CABLES FOR EVERY RADIO NEED

Whether you are building a "Super" or servicing a customer's set, you can always depend on Consolidated Radio products to fulfill your every requirement perfectly.

CONSOLIDATED products are distributed by America's leading Jobbers and Dealers everywhere. Send for our latest catalog.

**CONSOLIDATED  
CORPORATIONS**

Peoria & Harrison Sts., Chicago, Ill.

## A-C CURRENT-ANYWHERE!

WITH Kato LIGHT PLANTS! A Little Gas & a Kato AC plant enable you to operate transmitters, AC radios, amplifiers, refrigerators and all other standard household appliances. Sizes 300 watts and up. Write for interesting descriptive literature.  
KATO ENGINEERING CO., Mankato, Minn., U. S. A.  
Mfg's of AC Generators and Converters for operating AC Radios on 32 and 110 volts DC.

## RADIO CLUBS

Special Group Subscription Rates are offered if 5 or more members subscribe at one time. Write for rates.

"RADIO," Pacific Bldg., San Francisco, Cal.

## for YOUR antenna

Type "O" Transmitting Antenna System

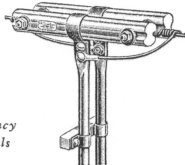

Better Efficiency  
Louder Signals

No. 31 Transposition Insulator (Pat. Pend.)

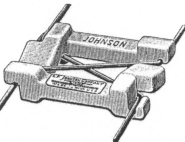

The JOHNSON line also includes "stand-offs," antenna insulators, airplane insulators, feeder spreaders, tube sockets, plugs and jacks, transmitting condensers, inductors, clips and handwheels, 5-meter antennas, doublet receiving antennas and doublet couplers. For all frequencies and all powers.

Sold by Authorized Johnson Distributors

**E. F. Johnson Company**  
Manufacturers of Radio Transmitting Equipment  
Waseca, Minnesota, U. S. A.

## SHALLCROSS WHEATSTONE BRIDGE

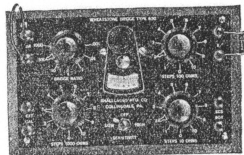

Built around a highly sensitive galvanometer and Shallcross Resistors. Range .01 ohms to 11.1 Megohms.  
Send for Bulletin 680-B describing this instrument.  
**SHALLCROSS MFG. CO.**  
COLLINGDALE, PENNA.

## SMITH-PRECISION CRYSTALS

Full-sized, specially ground X cut crystals; powerful, accurately calibrated, single-frequency oscillators. Unconditionally guaranteed.  
3500-4000 kc  $\frac{1}{2}$ "—Close to Frequency, \$2.35  
7000-7500 kc  $\frac{1}{2}$ "—Close to Frequency, \$3.95  
3500-4000 kc  $\frac{1}{2}$ "—To Exact Frequency, \$2.90  
465-525 kc  $\frac{1}{2}$ "—S.S. Filters X Cut. . . \$2.60  
Paid by airmail.  
Commercial Frequencies at Attractive Prices.  
**W. W. SMITH W6BCX**  
Pioneer Manufacturer of  
Fine-Quality Piezo Plates  
215 West Cook Santa Maria, Calif.

## General Electric B.F.O.

(Continued from page 10)

sulation. All connections in the adaptor are straight through from socket to pin except the suppressor grid socket connection which is connected only to the cable lead. Other cable leads are to filament and screen grid and one lead to link terminal No. 1 on rear of chassis.

The same shield can be used on the IF tube with the adaptor in place. It will be necessary, however, to knock out the top and replace it in an inverted position as may be seen in the picture. It may be necessary to slightly bend in top of the can in order to do this. It will also be necessary to cut out a slot in the shield and in the shield base to permit the cable to run out from the adaptor and to lengthen the control-grid lead approximately one inch.

The picture of the oscillator shown in Fig. 2 may be used as a guide in its construction although almost any other arrangement is permissible.

Since there is some slight variation in coils it may be found that the value of fixed condenser across the tuning coil may vary somewhat from the 500 mmfd. used with coil illustrated. This may be determined by trying values of 400 mmfd., 500 mmfd., 600 mmfd. and adjusting the variable condenser each time. A decided swishing noise will be heard as the oscillator frequency is adjusted to the same as that of the intermediate frequency, or if a milliammeter is available it may be

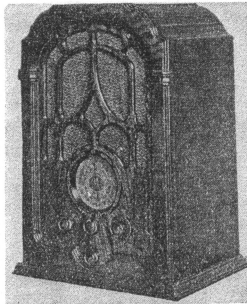

Front View of G. E. All-Wave Receiver

inserted in place of the link between terminals No. 1 and No. 2 on the rear of the chassis. The adjustment should be made to the point where the lowest reading is obtained on the milliammeter. This reading should decrease from one-half to one milliamper from normal reading of about fifteen milliamperes as the adjustment is made. It has been found by experiment that this amount of decrease is correct and is determined by the value of R3. If the decrease is found to be other than the amount mentioned, the value of R3 may be varied until the desired result is obtained. The antenna should be connected to chassis while this adjustment is made.

It will be necessary to slightly change the adjustment of the IF plate circuit tuning condenser accessible on the receiver chassis. It is the second from the left facing rear of chassis. With a weak broadcasting station tuned in on the broadcast band and the adaptor in place but with oscillator turned off, the IF trimmer condenser should be adjusted with a screw driver for maximum signal. This is necessary because of the slight capacity added by the adaptor and its leads.



NOTE! Those who wish to advertise in these RADIOADS columns and who do not desire to divulge their names and addresses can use BOX NUMBERS, and all inquiries will be mailed, unopened, to the advertisers.

**5-METER RADIOTELEPHONY.** Great new book by Frank C. Jones, designer of San Francisco Bay Bridge 5-meter equipment. Dealers, distributors and sales agents wanted everywhere. Ready for distribution in 30 days. Shows many heretofore unpublished circuits for single-tube 5-meter transmitters, receivers and transceivers. The book will sell for 25¢ per copy. Send quarter in coin now for advanced copy. Publishers of "RADIO", Pacific Bldg., San Francisco, California.

**FACTORY-BUILT S.W. Transmitters, Receivers, Equipment.** Send stamp for catalogue. Ellen Laboratories, 24 West 20th St., New York City, New York.

**CRYSTALS—80 or 160 meter bands, 1 inch square, Y-cut, accuracy .002%, \$1.50 each. W8CHJ, 9255 Herkimer St., Detroit, Michigan.**

**BACK COPIES OF "RADIO", 25¢ each, some issues, can be secured from the New York office. Address your orders to Edw. J. Byrne, 253 West 128th St., New York City, New York.**

Twice as Big as Before  
IS

## THE SECOND EDITION of KRUSE'S RADIOPHONE GUIDE

• and is just as full of operating and constructional information that isn't found elsewhere.

• And furthermore . . . there's a complete set of

**Batcher's 'Radiographs'**

the simplest problem-solvers we ever saw.

• At your dealers or Postpaid for 50¢ (Canada 75¢)

**ROBERT S. KRUSE, Guilford, Connecticut**



These condensers are ideal for shortwave equipment. Tested at 2500 and 5000 volts for use in small radio transmitters. For maximum efficiency use these low loss units.

Write for catalog sheet

**SANGAMO ELECTRIC CO.**  
SPRINGFIELD, ILLINOIS

## HARVEY TRANSCEIVERS

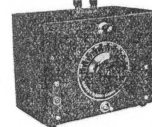

Compact!  
Light!  
Efficient!

Quality and Performance Available in Two Models

2-volt Tubes . . . . . \$18.75  
6-volt Tubes . . . . . \$17.95

2.04 Tubes . . . . . 1.68

## 5-10 METER TRANSMITTERS

**MO-71:** A 5-tube transmitter with class B modulation having an output in excess of three watts.  
**MO-45:** A five tube transmitter also with class B modulation having an output in excess of eight watts. Both the above are mounted on attractive punched steel chassis finished in black crystal lacquer. The 17" length permits standard rack mounting. Price of either unit wired and tested including tubes but less power supply . . . \$29.50

Write for literature on the above apparatus  
**HARVEY RADIO LABORATORIES**  
12 BOYLSTON STREET BROOKLINE, MASS.

## Quartz Crystals

for the Commercial and Amateur Station  
COMRADECO Crystals are recognized by the commercial radio man as a dependable product—fully guaranteed. Yet, COMRADECO Crystals may be purchased by the discriminating amateur at prices no higher than market prices with the additional guarantee of quality, performance and precision.

**PRICES**  
1715-2000 and 3500-4000 Kcs. . . . . \$3.50  
All crystals are supplied close to your specified frequency and the calibration at room temperature is accurate to .05%.

**HOLDERS, dustproof, plug-in type . . . . . \$2.00**  
NOT a flimsy, molded affair, but a scientifically designed holder with good heat attenuation, thus eliminating excessive frequency "creep." Ruggedly built to commercial standards.

**FREE** Full descriptive literature of crystals, ovens, frequency meters, etc., will be sent to licensed amateurs and responsible parties upon request.

**Commercial Radio Equipment Co.**  
P. O. BOX 7022 KANSAS CITY, MISSOURI



**New Book—Just Out!**  
"5-METER RADIOTELEPHONY" By FRANK C. JONES  
25 cents per copy. Sold by "RADIO", Pacific Building, San Francisco.

Best and Most Complete 5-Meter Book Ever Published

## Engraved Terminal Plates

WRITE for complete bulletins just printed showing several types of terminals and other useful items for every short wave transmitter. Select type of terminal and send us sketch of panel with dimensions. Show location of terminals with lettering and numbering. Quotation will be sent by return mail.

Our products have been used by manufacturers for over ten years  
**HOWARD B. JONES**  
2300 WABANSIA AVE. CHICAGO, ILLINOIS

## Versatile Receiver

(Continued from page 11)

This two-tube circuit will drive a small magnetic or dynamic speaker with fairly good volume. If greater volume for speaker operation is desired, it is merely necessary to add another 76 (or 56) audio stage, or a 2A5 (or 4J1) can be used for the enjoyment of the people upstairs.

The builder of a receiver such as the one herein described is cautioned to adhere rigidly to the list of parts used, if best results are desired. Several months of painstaking "fiddling" with dozens of circuits has resulted in the selection of the circuit shown here for best all-around amateur and short-wave reception. You will hardly find a more versatile, more stable and more satisfactory circuit.

Electron coupling is used. Regeneration is controlled by a 50,000-ohm variable potentiometer in the screen circuit. The control is so smooth in operation that one hardly knows when the receiver goes into regeneration. This is a very convenient feature in a receiver, especially when voice reception is listened to. The volume control is a 500,000-ohm Electrad potentiometer in the grid circuit of the audio stage.

Changing the plug-in coils used with the miniature iron-rod receiver is made simple by a front-of-panel plug-in coil arrangement.

The coils are wound on standard Hammarlund 1/2-inch Isolantite coil forms.

## Hum Problems

SOMETIMES a very disagreeable tunable hum is heard when using the 30 or 40 meter coils. This hum "rides the power line," so to speak, and can be eliminated by connecting a .1 mfd. condenser from one of the plates of the rectifier to ground. In some cases it may even be necessary to by-pass both plate leads to ground.

If a slight trace of hum is still prevalent in the receiver proper, after all means to eliminate it have failed, use a .0002 mfd. fixed coupling condenser between the plate of the detector tube and the grid of the audio tube, instead of the .02 condenser shown in the circuit diagram. However, the use of a .0002 mfd. coupling condenser will cut off the low notes, if the receiver is used for listening to broadcast music. On the other hand, a lot of "highs" are preferable for headphone reception, especially when listening to CW signals. It is better to eliminate the last trace of hum from the receiver by use of the .0002 mfd. coupling condenser and sacrifice some of the "lows."

The clean-cut, sharp voice reception and the high-pitched CW whistles which result from the use of the .0002 mfd. coupling condenser are very pleasing to the ear.

If you don't want to use impedance coupling between the detector and first audio, or if you cannot secure a 100 to 500 henry choke, the use of resistance coupling will give almost equal satisfaction. The gain will be reduced a trifle . . . not enough to worry about. Merely substitute a 250,000 ohm resistor for the impedance.

A switch can be placed in the negative "B" circuit to cut the power supply from the receiver while transmitting. A second audio stage, using a 2A5, resistance coupled, can be connected to the first audio stage and the power output will be sufficient to drive a large dynamic speaker. If there is evidence of motor-boating when the 2A5 stage is added, the motor-boating can be eliminated by using a small value for the coupling resistor; .001 has been found to be satisfactory.

Another means for reducing what little hum may remain in the 2A5 output stage is to use two 250,000 ohm resistors, connected (Continued on page 38)

## Here's a NOISELESS Transmitter GRID LEAK

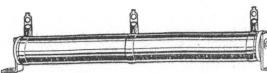

ELECTRAD'S Transmitter Grid Leaks have exceptional advantages.

Wire-wound and vitreous-enamelled, they withstand high temperature, dissipate heat quickly, do not absorb moisture, and hold their resistance value permanently.

Monel metal lugs and contact bands do not corrode. They insure positive contact with the resistance wire, regardless of expansion strains. Guaranteed not to develop noise.

Type TG—190 watts—1 1/4" x 10"  
Type TL—90 watts—1" x 6"  
Type CF—40 watts—1/2" x 4"

## FREE Vest-Pocket Volume Control Guide



Write Dept. PR-7 For Complete New Catalog



## 5 NEW SHORT WAVE Receivers in Kit Form

ICA brings you the first and only complete line of Short Wave Receivers in all of Radio! Now your every requirement may be filled, for the Universal Master Line consists of a 3-tube battery operated set for beginners; a 2-tube battery operated set which performs like a 4-tube A.C. operated set giving loud speaker reception; a 4-tube A.C. set of extreme simplicity and amazing power; a 5-tube set for the "laid in the wool" S.W. enthusiast. All sets come in kit form; are licensed under RCA and Hazeltine patents and incorporate every latest improvement in circuits and tubes. Get our new, FREE descriptive literature which gives complete details, prices and discounts of the entire line. Address Dept. T-74.

**INSULINE CORP. OF AMERICA**  
25-25 PARK PLACE, NEW YORK, N.Y.

Brings You the Next 4 Issues of "RADIO"—Subscribe Now



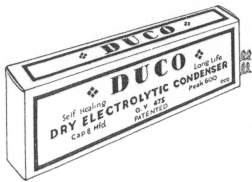

# -IDUCO-

"Best by Test"

All DUCO Condensers fully guaranteed for one year.

IN NO OTHER CONDENSERS DO YOU FIND THESE FEATURES:

1. DUCO condensers are positively self-healing, even up to 3000 volts.
2. Better and longer life than the wet electrolytic condensers.
3. Smaller in size than any other make on the market.
4. For economy in costs it has no equal.
5. DUCO condensers in use over six years showing long shelf and use life.
6. All condensers are rated very conservatively.
7. Growing faster than any other make.
8. Used by best service men in the world.
9. Adopted by finest engineers of set manufacturers.
10. Guaranteed for one year.

DUCO CONDENSERS are fully protected by patents and patent applications all over the world. The response since we introduced our new condenser has been remarkable.

You, too, will be surprised at its performance.

Send for Free Catalog  
Sales and Jobber Territory Open

Mfg. by

**DUMONT  
ELECTRIC CO.**  
453R Broome Street

New York City, N. Y., U. S. A.



Osockne, Japan.

May 23rd, 1923.

Editor impersonator of "RADIO",  
Dear Ed.:

Upon receiving from you last previous copy of "RADIO" I come into hearty laughter which soon become so jovial that it turns into hysterics. Such jolly making come from reading of editorial article which show how to build large de-luxe super-sensation making receiving set which cost not less than three hundred dollars and sixty-five yen to build. But such specifications for receiver look interesting to Seratchi and only reason why duplicate of it cannot be built here by me is for lack of ready cash finances. I troop down to neighboring radio part store dealer and ask if he will supply such parts for mighty receiver on time-quick basis upon informing him of my present bank condition. He inform me not to worry about how much such parts for receiver will cost because anybody can have money if he think he have money. He say poverty is only a state of the mind. However, Seratchi find that such condition also find its way into pants pockets. Storekeeper salesman then tell me that new deal bring prosperity to all amateurs, and that each should by now have feathered chicken in pot. He ask me, "Seratchi, did you not get your chicken in the pot?" To wit reply with toothsome smile, "No, I didn't even get the pot!" To which reply he throw both hands up in air (but catch them again) and walk off smorting in disgust.

I then make haste to competing radio store across street where are gathered huge crowd of millions of people listening to broadcast radio from loud squawker in store front. One man in crowd say, "Hooray, Red Grange just kick off." I inquire from him if such man suffer much before kick-off but my question still remain unanswered.

When crowd disperse I walk into store and find that salesman have everything but which I want. Recollections then come to me that I am in need of quartz crystal for receiver filter. But storekeeper tell me he have no quartz in stock and ask if plints will do instead. I tell him in disgust that his store have never have anything which amateurs want. He then say to me that they specialize in monkey wrenches and when I look around me I find that I walked into wrong store, because regular radio store are next door.

So I stampeed next door and find huge sign hanging in window on which say "50% Off." I come to quick halt. I have never heard of such thing, 50% off. So I go into store to see what people look like who are 50% off and when I make size-up of cash register musicians, I come to conclusions that such people who run such store are far more than 50% off.

I then proceed to bank for purpose of making withdrawal of money sums to buy receiver parts needed. I write check for three hundred yen and give to paying teller but when he look at size of check and then make investigation of my finances account he tell me that maybe it be far better for me to pay money to bank instead of bank paying money to me, because bank got big expenses to meet, so he take check and stretch it out four feet and let it bounce into wastebasket.

I then make haste to my other bank, but find front and back doors closed with fancy sign hanging on door which say, "Greetings to all customers. This bank go broke. Depositors get Mexican stand-off. . . You lose your money but you save your life."

Without amateur receiver at disposal in Seratchi house your honorable writer must contend with listening in to bel chatter. Mrs. Mima, YF Seratchi tell me she listen to bel program which tell how to make fine radio recipe candy, but such candy sure taste like it are full of bel. YF Seratchi also get radio bel instructions on how to make fancy tapestry pieces for hanging on household wall and on such tapestry decorations for women great famous sayings of dead and dying authors. One specially in tapestry which hang on wall of Seratchi radio shack say on it "God Bless Our Ohm".

In the meantime until I can complete new amateur receiver I have decided to observe honorable silent period because I have nothing to listen with anyway. Hoping you are doing the same, I am,  
Your friend and genius,  
Seratchi.

### Low Range FUSES

INSTRUMENT LITTLIFUSES  
1/100, 1/2, 1/4, 1/2, 3/4, 1, and 2 amps, positively protect meters, radio, amplifiers, etc. Also made in 1000, 5000, and 10,000 volt ranges for broadcast equipment, etc. \$100 Protection Guarantee. There is a distributor near you. LITTLIFUSE LABORATORIES

Write today for  
Instructive bulletin.  
4503 Ravenswood Ave.  
Chicago, Ill.

### ... UNBIASED

Many unusual troubles and faults not easily disclosed by the set analyzer, with full instructions for their remedy, are fully described in this handy, pocket sized 180 page book.

Compiled from the actual records of many thousands of service calls. Over 500 different receivers treated, contains 50 diagrams.

The Author has no connection with any branch of the manufacturing industry. He had no axe of his own to grind when he wrote "Actual Troubles." His daily contacts in the servicing field gave him the foundation for writing this frank, unbiased manual.

TEN DAY FREE TRIAL  
A supplement is now being prepared and will be mailed to you (next September) at no additional charge.

Sold on a money back, ten day free trial guarantee.  
SERVICEMENS PUBLISHING CO.  
136P Liberty Street New York, N. Y.

# Collins Transformers

FOR 5-METER TRANSMITTERS AND BATTERY AMPLIFIERS

The Very Best Transformers Obtainable

Collins Equipment is widely accepted by amateurs and other discriminating users

Type No.	DESCRIPTION	Weight	Price
740 Z	Class B Output 53's, 79's, 19's, 49's to 5000-7000 ohms.	15 oz.	2.00
741 Z	Class B Output 53's, 79's, 19's, 49's to 2500-3000 ohms.	15 oz.	2.00
742 Z	Class B Output 53's, 79's, 19's, 49's to 3-8-12 ohms.	7 oz.	2.00
750 X	Class B Input 19 driven by 30	7 oz.	2.00
752 X	Class B Input 19 or 49 driven by 81	7 oz.	2.00
753 X	Class B Input 19 driven by 37	7 oz.	2.00
754 X	Class B Input 53 driven by 56 or 53.	7 oz.	2.00

**COLLINS RADIO COMPANY**  
Designers and Manufacturers of  
Transmitters, Transformers and Speech Equipment

CEDAR RAPIDS, IOWA.

# TUNING CONTROLS

FOR RADIO SET MANUFACTURERS

New Airplane Type  
in Ten Styles

More Than 50 Kinds Shown in Our Catalogs  
Also Escutcheons, Cabinets, Name Plates and Other Specialties

Write for Catalog

REMOTE CONTROLS  
FOR AUTO RADIOS

EXPORT ORDERS RECEIVE SPECIAL ATTENTION  
Cable Address—CROWNAME CHICAGO  
Jobbers and Dealers Find Our Line Profitable

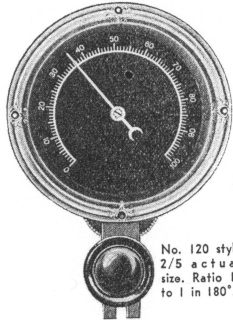

No. 120 style  
2/5 actual  
size. Ratio 12  
to 1 in 180°.

**CROWE NAME PLATE & MFG. CO.**

1755 GRACE STREET Established 35 Years CHICAGO, ILL., U. S. A.  
Pacific Coast Representative, W. BERT KNIGHT, INC.

Airplanes, Blimps, Broadcasting Stations,  
Commercial Operators, Hard of Hearing, or  
wherever exacting performance under all  
conditions is required,  
you will find TRIMM HEAD-  
THERWEIGHT head-  
phones. Mechanically  
rugged, electrically accu-  
rate, they excel by test.  
We invite your headphone  
problems.



F-100  
Ask your favorite jobber, or write us for information  
**TRIMM RADIO MANUFACTURING COMPANY**  
The Pioneers in Headphone Development  
1528 ARMITAGE AVE. CHICAGO, U. S. A.

QUALITY  
at a Price You Can Afford to Pay!



**FRANKLIN  
Transformers**

Very conservative ratings on Transformers and Chokes for every Amateur Station.

"MOST SOCK PER DOLLAR"

Write for Catalogs  
**FRANKLIN TRANSFORMER MFG. CO.**  
607-609 22 Ave. N.E., Minneapolis, Minn.

# 5B CHOSEN IN PREFERENCE TO ALL COMPETITION . . . . Selected as official

Communication Receiver at W9USA . . .

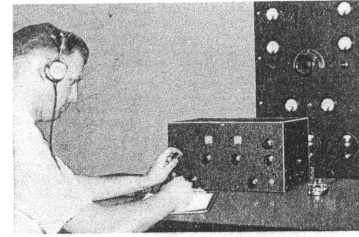

One of the 5B's at W9USA being operated by D. L. Warner, W9IBC

The 5B has won the enthusiastic approval of Col. Foster and hundreds of amateurs who know. The latest honor accorded it, namely selection by W9USA is but further proof of the 5B's perfectly obvious excellence and superiority.

SEND 3c stamp for new complete catalog describing above items, E. C. Frequency Meters, New Airplane Dials, Relay Racks, RF Chokes, Audio, Power and Filter Transformers, and a host of new and interesting amateur and commercial apparatus.

## — SPECIFICATIONS —

- Circuit—Eight-tube superheterodyne.
- Tables—58 tuned RF, 2A7 1st detector—E. C. oscillator, two '58 tuned IFS, '58 audio beat oscillator, 562 second detector, '59 output, 5Z5 rectifier.
- Range—1550 to 30,000 KC—five amateur bands on 1 dial.
- Tuning—One main illuminated vernier tuning dial, smooth and easy, directly calibrated in megacycles. Band spread tuning anywhere in range—amateur, broadcast, commercial.
- Power Output—3 watts undistorted. Supplied complete with Jensen dynamic speaker, and head phone jack on front panel.
- Shielding—100% perfect, all parts individually shielded.
- Overall cabinet shield easily removable with 6 thumb nuts.
- Selectivity—Circuit designed, built and adjusted for crystal resonator, without crystal, band width 21 KC 10,000 times down. With crystal, absolute single signal (50 cycles wide).
- IF Amplifier—Dual air tuned, Litz wire . . . 465 KC.
- Beat Oscillator—Electron coupled '58. Beat note pitch adjustable from front panel.
- Sensitivity—Better than one microvolt absolute.

**McMURDO - SILVER, INC.**  
3362 N. PAULINA ST. CHICAGO, U. S. A.

PRICE  
\$59.70

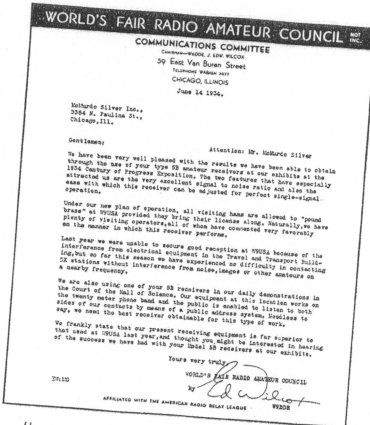



D. E.

## DEPENDABLE RATINGS

While the STANCOR engineering staff was planning and designing this line of transformers for Amateur Transmitting, one of the things that was kept constantly in mind was this—

The Amateur must be able to absolutely depend on Stancor ratings.

And further, these ratings must be conservative... there must be a broad factor of safety in every unit... overloads must be anticipated and every transformer designed and built to absorb them.

And that is the way they were designed... that is the way they are built.

STANCOR Transformers for Amateur Transmitting cover practically the entire range of your requirements... for whatever tubes you may desire to use

... for the beginner or for the more advanced Amateur who is adding more power or changing to phone transmission.

STANCOR Transformers for Amateur Transmitting are distributed throughout the United States, Canada and our Island possessions through the same STANCOR authorized distributors that make available to the service man STANCOR EXACT-DUPLICATE Replacement, Universal Replacement Power Transformers, Audios and chokes.

If you are not familiar with the name of the distributor in your community, write this office and we will inform you, at the same time sending you listings and other details of these most modern and highly efficient transformers, specially designed and built for your particular requirements.

## STANDARD TRANSFORMER CORPORATION

860 Blackhawk Street, Chicago, Ill.

### QSL'S

We make every effort not to see how cheaply QSLs can be made, but to make the finest available funds for the work permit. At your request, you will receive a few samples—ideas of others—and prices. See what improvements you can make upon them, and let us create your ideal!

CHAS. E. SPITZ  
(W6FZQ) PHOENIX, ARIZ.  
BOX 1804

For better and longer service, better filtration with no current leakage,

Use G-H PAPER WOUND ELECTROLYTIC REPLACEMENT CONDENSERS

GIRARD-HOPKINS, Oakland, Calif.

### Latest In "B" Power



Smallest unit on the market. 2 1/2" wide, 4" high by 1 1/2" long. This complete Generator furnishes up to 200 volts D.C. Operates from 6 volt storage battery, ideal for Auto, Airplane or Battery Radios, and Portable Amplifiers.

Write for details and prices on this and other types.

CARTER MOTOR CO.

365 W. Superior St. Chicago, Ill.

### Versatile Receivers

(Continued from page 35)

in series, from the grid of the 2A5 tube to ground. Then connect a 1 mfd. condenser between ground and the point where the two resistors are joined together.

Only one iron-core choke is needed in the power supply filter circuit in addition to the field coil of the dynamic speaker, which acts as a second choke. 8 mfd. condensers across the two chokes (and condenser input) will give ample filtration. But to be absolutely on the safe side, it is wise to connect another 8 mfd. condenser across the positive and negative B terminals at the point where they connect to the dropping resistors in the receiver proper.

A "bleeder" resistor of 25,000 ohms can be connected directly across the high voltage output of the power supply in order to protect the filter condensers.

### Broadcast Coil

WIND 75 turns of No. 30 enameled wire on a 1 1/2-in. diameter form for the secondary, and 4 turns of the same wire for the tickler, and you can bring in a half dozen of the low-wave broadcast stations on this receiver, using the .0001 mfd. tuning condenser as originally installed. Wind another coil with about 85 turns for the secondary and 4 turns for the tickler, and you can tune in the higher-wave stations. All coils for this receiver use the same number of turns for the tickler... 4 turns.

Those who do not care to wind their own coils can secure a complete set of "GAINER" coils, ready wound, from Modern Radio Laboratories. The latter, known by the trade name of "MRL," are wound on celluloid forms and have given excellent results in "THE GAINER."

### HUM—Tunable and Otherwise

MANY two-tube receivers suffer from hum of one kind and another. The causes can usually be divided up into two classes: hum that is a pure function of the power supply, either due to inadequate filtering (or spurious oscillation from mercury vapor rectifiers) and hum that originates in the receiver proper.

The cure for poor filtering is obvious—either use more condensers, better chokes or replace the electrolytic condensers with paper condensers. Reversal of the 110 power plug will often clear-up a stubbornly persistent hum. A pair of .01 mica condensers from either side of the secondary of the plate transformer to negative is also a fine bet when all else fails. The addition of RF chokes will cure the hum from mercury vapor rectifier trouble.

Receiver hum can be generally traced by checking the following sources of trouble:

- 1—Antenna resonant to working frequency. Cure: Change length of antenna.
- 2—Grid lead or grid condenser too close to chassis.
- 3—Filament lead paralleling grid circuit wiring.
- 4—Poor, ineffective RF choke in the plate lead of the detector.
- 5—Filament hum. Cure: Ground one or the other side of the heater to chassis.
- 6—Pickup from adjacent 110 volt lines. Cure: Completely shield tubes and ground chassis with a good, external ground. Also caused by too-close coupling of antenna to receiver. If this is the case, the panel usually will be "Hot" and very bad hand capacity will result.

- 7—Hum from audio. Usually cured by increasing the size of the by-pass condenser across the cathode resistor. In the case of Pentodes, such as the 2A5, it may be necessary to add an additional 200,000 ohm resistance and a 2 mfd condenser in a degenerative network filter. The connection for this has been shown many times in this magazine.
- 8—Hum due to cathode shorting to heater.
- 9—Persistent hum can often be cured by decreasing the size of the coupling condenser from the plate of the detector to the grid of the audio. In extreme cases this condenser can be made as small as .006 with, of course, a consequent loss in low frequency response in the output.
- 10—Transmitter hum picked-up by the receiver can usually be attributed to the use of resistor bias in the RF stages. A 4 1/2-volt C-battery in series with the resistor will cure the trouble.

### Col. Foster's Comment

(Continued from page 4)

ness. The new deal, effective July 1, 1924, prescribed a salary \$600 a month plus 10% of the net profits of the whole organization. But Warner was acute enough to demand and get the proviso that if the directors wished to make any unusual expenditures such moneys must come out of surplus and not from current revenues or gains.

Warner's additional prerequisites for the first half 1924 were \$5,699. His commissions for the second half under the new arrangement were \$1,035. There was no longer the rake-off out of the "yearly dues", you see. But his total drag out of the treasury, salary and all, for the year amounted to \$11,114.

The next two years there were no profits, so Warner had to struggle along on \$600 a month. But in 1927 he drew down a total of \$9,364, and in 1928 a total of \$9,978.

At the 1929 meeting of the board Director Babcock moved to give Warner a straight salary, to begin January 1 of that year, with no commissions. Counsellor Segal, who was then a director, jumped up and moved to amend by striking out the \$10,000 and making it \$12,000. Nobody bit, so it had to stay at \$10,000 for that year. But, not to be discouraged, Segal was out to get Warner that \$12,000. At the 1930 meeting somebody moved to make it \$11,000, together with a boost to \$500 a month for Hebert. (Hebert is not the acquisitive type or he as an old-timer in the ARRL would have been in on the gravy long ago). The Honorable Paul wasn't worrying any about Hebert. The depression was well under way and thousands of fine radio men with families were walking the streets with no jobs at all, so Segal no doubt felt that Hebert could make out on \$500 a month; but he moved to amend by giving Warner \$12,000. This time all directors bit. The Honorable Paul's mission in life seems to be to establish the monetization of Mr. Warner.

Throughout the past four blighting years, 1930-1933, most of those fine radio men with families are still hunting jobs, while during that time Warner drew out of the ARRL treasury just \$44,206.03! I hate to make myself look niggardly by mentioning those 3 cents but I must do so in the name of accuracy.

I have shown you what this turning over the ownership of the ARRL to non-amateurs did for Warner. What it did to the licensed amateurs of the whole United States is another story and a much longer one. I shall give it to you in a later letter. For the present it is enough to say that the amateur owners of ARRL and QST have been despoiled of some 80% of their property and that Warner's commercial and non-amateur employers now outnumber by about 4 to 1 his amateur employers. Warner has steadfastly refused to disclose the actual percentage on the ground that it can not be accurately ascertained. It is, of course, changing from day to day but a close approximation can be had at any time merely by checking the membership list against the latest amateur call-book.

In 1931 Warner made affidavit to the U. S. Treasury Dept. for the purpose of securing for the ARRL exemption from income taxes. The affidavit is many pages long and addresses itself largely to the claim that the ARRL is a scientific and educational association; such associations—like the National Geographic Society, for example, being exempt. The ARRL is pictured as amateur, non-profit and non-commercial. If Treasury Dept. investigators had been given a look at where an inordinately large part of the ARRL income has been going for many years I venture to say they would have concluded that our Uncle Sam was entitled at least to a part of it.

Now a word about directors. Directors of a going concern that is doing the annual business of the ARRL and that has a considerable portfolio of gilt-edge securities sailed away are, literally, trustees for the owners. If they are not competent and willing actually to direct then they should not accept the trust. They are responsible under the law for careful management of the business and for the conservation of its assets. To be competent they must familiarize themselves with the character and extent of the business in the past as well as the present. And yet I doubt if few if any of the present directors except some of the oldest have had knowledge of the conditions I have outlined in this letter. Your own director of your Roanoke Division is a dyed-in-the-wool Warner supporter, and yet I venture to say he is unfamiliar with even the few vital concerns I have here described to you. The machinery of the ARRL is not designed to provide the directors with all the facts and then permit them to do their own thinking. Such facts as are presented to them are merely those that the officers see fit to divulge; and even such facts are dressed up with the obvious purpose of guiding the thinking of the directors. The directors of the ARRL don't direct anything to speak of. They don't even direct their ATTENTION except once a year, and then even that is directed for them. You had a specific and flagrant instance of this in the way, first, the truth of the amateur restrictions of Madrid was withheld from the directors, and, then, the way the determination of policy as to whether Madrid should or should not be ratified was kept out of the directors' hands.

I have been censured from hither to yon—from the president of the ARRL down to the kid ham in the street—for my not going to Madrid. In the May issue of "RADIO" I told you why I didn't go. With the United States delegation, the United States commercial, Warner and Segal all against me it is wholly unlikely I should have accomplished anything towards keeping the obnoxious new amateur clauses out of the treaty, but you can bet your last nickel that the directors and the amateurs of the United States would have learned the truth in just the time it would have taken me to get to the cable office instead of their having to learn the bad news months later through outside sources. If I had gone to Madrid the United States amateurs would not have lost six months in their fight to get the obnoxious clauses deleted.

Now, this is by no means the whole story of what happens when you have ultra-acquisitives on the job at all times and a majority of directors who, when they are on the job at all, are working WITH the ultra-acquisitives. But as much as I have told you here will have provided you with enough of the inside story so that the next time you are backed up against the wall at a hamfest by the present ARRL regime you won't be wholly without ammunition.

73, and "better luck next time".

(Signed) Clair Foster, W6HM.

**RADIO'S GREATEST VALUES**

100 Pages: Filled with latest Design Portable, Mobile and Rack & Panel, Public Address Amplifiers, Short-Wave and All-Wave Receivers and Converters, Inter-Office Call Systems, Test Equipment, Replacement Parts, Kits, Tubes, and Accessories—all at Unbeatable Book Bottom Prices! Send for Your Copy Today!

**COAST TO COAST RADIO CORP.**  
125 A WEST 17th STREET, NEW YORK, N. Y.

**free**

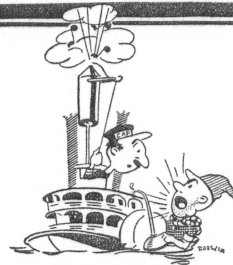

## Don't use all the steam for the whistle!

We could easily build so gosh-darn much D. C. resistance into our suppressors that you couldn't hear a Tesla coil exploding in your gas tank... But you wouldn't get any power either. It's a case of knowing just the exact ratio of R. F. to D. C. resistance.

and, boy—CENTRAL RADIO LABORATORIES has the answer.

CENTRAL RADIO LABORATORIES  
Milwaukee, Wis.  
**Centralab**  
Motor Radio Noise Suppressors



## SPECIAL RADIO RECEIVERS

Short Wave - Broadcast - All Wave

For AMATEURS YACHTS RESIDENCES EXPORT

20 YEARS' EXPERIENCE

Literature on Request

**CHARLES R. LEUTZ**  
FOREST HILLS GARDENS, NEW YORK

### LITTLE DYNAMITE

A powerful high quality amplifier yet extremely compact in size (measuring 4 1/2" x 3 1/2" x 1 1/2"). Has excellent response over the audio band. Especially suitable for small or portable P. A. systems, for recording and for use in conjunction with phono coils, etc. Uses a 27 high gain pentode and the dual triode 2B6 tube. An 80 tube provides humless plate supply. Overall gain 80.5 db. List price less tubes \$23.50, dealers and amateurs net price, \$8.95. Three Arcatrus tubes, net \$3.15. ALAN RADIO CORP., 83 Cortland St., New York City, N. Y. Write in for free "Alan Sound Handbook" off the press soon.

Radio Dealers and Jobbers who desire to advertise in these columns are invited to write for rates.

# RADIO BUYERS' GUIDE

A Monthly Listing of Reliable Radio Dealers and Jobbers who solicit the patronage of our readers. Buy from your nearest Dealer or Distributor. He is dependable and reliable.

## CHICAGO, ILLINOIS

Chicago Radio Apparatus Company, Inc.  
415 South Dearborn Street  
Harrison 2276  
Dependable Radio Equipment  
Established 1921  
Bulletins on request—we specialize in short wave transmitting and receiving apparatus.  
Catalog Ten cents.

## CHICAGO, ILLINOIS

MID-WEST RADIO MART  
520 South State Street  
CHICAGO  
Write for Special Catalog—Free

## CHICAGO, ILLINOIS

Newark Electric Company  
226 W. Madison St.  
Chicago  
All Kinds of Equipment for Service Men - Amateurs - Experimenters  
Write for free catalog

## OAKLAND, CALIFORNIA

RADIO SUPPLY CO.  
2085 BROADWAY.  
New 2-Tube Sargent DX-Ranger Kit, \$12.50 complete  
New Sargent 9-33 Superheterodyne, \$69.50, net, less tubes  
Sargent Short-Wave Sets and Kits.  
Write for Circulars.

## ST. PAUL, MINNESOTA

LEW BONN COMPANY  
2484 University Avenue  
Rex L. Munger, W9LIP, Sales Engineer  
Radio Wholesaler Complete Stock

## ST. LOUIS, MO.

HAMS' TRADING POST  
Want to buy? We have it to sell. Want to sell? We will buy for cash. Want to trade? We will trade. References—any Midwest ham.  
WALTER ASHE RADIO CO.  
121 North Eleventh

## CHICAGO, ILL.

Allied Radio Corporation  
833 W. Jackson Blvd.

5 meter Headquarters. Complete Stocks of all standard lines of transmitting equipment, replacement parts, tubes, etc.

Write for our 100-page free catalog



### Amperite Ribbon Velocity Microphone

EVEN today, the quality of a good amplifier or transmitter built five years ago cannot be greatly improved. A good condenser or ribbon microphone, however, will greatly improve the quality of any installation. In fact, it is by far the easiest and cheapest way to noticeably improve any radio station or public address equipment.

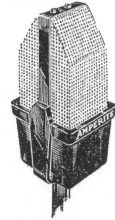

Ribbon microphones are, therefore, rapidly gaining their just popularity. The new Amperite Ribbon Microphone incorporates a number of novel and improved designed features. The cavity resonance of the case is entirely eliminated by the properly designed screen construction which permits free path to the sound waves. The case is also heavy enough to withstand a great deal of abuse. The pole pieces are machined and placed in such a way as to obtain the highest flux density in the gap. Although smaller in size, the magnets are more powerful than the larger ones used in former designs. This is made possible by the use of 35% Cobalt Steel. The ribbon is hand hammered to .0002-in. The output of the microphone is approximately -80 dba, and has a flat response from 60 to 10,000 cycles (1 db. difference).

Besides giving the most faithful conversion of sound to electrical energy, the ribbon microphone is excellent for eliminating acoustic feedback. This fact and its low selling price makes the new Amperite Velocity Microphone ideal for public address work.

In using an Amperite Velocity Microphone, one must be careful in trying to reproduce sound effects. A vacuum cleaner will not sound like a wind storm to the radio audience, it will sound like a vacuum cleaner.

### New 5-Meter Antenna

A UNIQUE high-efficiency antenna for 5-meter transmission and reception has just been announced by the E. F. Johnson Company of Waseca, Minnesota, manufacturers of radio transmitting equipment. The efficiency of the unit is approximately 3 db. above that of a simple, current-fed antenna due to accurate impedance matching secured through a properly designed quarter-wave line section which also serves as a support.

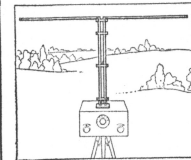

The Johnson antenna is designed for convenient installation, either at a fixed station or under a variety of conditions encountered in portable work. Thus it is possible to mount the antenna directly on a transmitter or portable receiver, or the antenna may be suspended in the air between convenient supports (for increased optical range) with a transposed transmission line back to the main equipment. Impedance remains accurately matched regardless of the method of use. With the aid of simple plug-and-jack fittings, the change from direct plug-in mounting on case to overhead suspension may be made quickly and easily without tools. No internal wiring changes or transmitter readjustments are necessary. Prices, \$6.50 and \$9.50. Later model has Mycale insulation.

## CHICAGO, ILLINOIS

Chicago Radio Apparatus Company, Inc.  
415 South Dearborn Street  
Harrison 2276  
Dependable Radio Equipment  
Established 1921  
Bulletins on request—we specialize in short wave transmitting and receiving apparatus.  
Catalog Ten cents.

## PITTSBURGH, PENNSYLVANIA

CAMERADIO COMPANY  
603 Grant Street  
Tri-Set "Ham" Headquarters  
Standard Apparatus Standard Discounts

## FRESNO, CALIFORNIA

PORTS MANUFACTURING CO.  
3265 E. Belmont Ave. Radio W6AVV  
National FB7-SW3 and Parts; Hammarlund, Cardwell, Billey Crystal; Johnson Insulators.  
Complete Stock - Write for the Dope  
Established 1914 - Leading Ham Supply Store

## SAN FRANCISCO, CALIFORNIA



1452 Market Street.  
"The House of a Million Radio Parts"  
Hammarlund and National sets and parts.  
RCA-DeForest Amateur Transmitting Tubes.  
Collins Transmitters.  
Arcturus Receiving Tubes.  
Trim Phones, all types.  
Johnson Antenna Feeders, Insulators, Transposition Blocks.

## SEATTLE, WASHINGTON



LARGEST PARTS SUPPLY DEPT  
IN THE NORTHWEST

Four of Our Employees Are Licensed Amateurs

DISTRIBUTORS  
DUBILIER-WARD LEONARD  
CARDWELL-RCA TRANSMITTING TUBES  
WESTINGHOUSE METERS

## VANCOUVER, B. C.

Palmer Radio Supply Company  
524 WEST PENDER STREET  
B. C.'s Original "Ham" Supply House  
Everything for the Amateur and Service Man  
Write for Catalogue.

RADIO FOR JULY

# CROSLLEY INVENTION



Only \$150.00 DELIVERED

As easy to get under the Coolrest Canopy as to get into an ordinary bed - and what a difference!

## THE COOLREST AIR CONDITIONED BED CANOPY

(Patents Pending)

Western Price Slightly Higher

Electrically air conditioned compartment fits over bed to bring comfortable, healthful sleep on nights as hot as the steaming jungle. A New Market—Ready, Wide Open—Including Homes, Hotels, Hospitals... wherever there are people who need or like refreshing sleep on hot, sticky nights.

Now nearly everybody can afford to sleep in cool, air conditioned comfort on hot, sticky nights. The Crosley Coolrest air conditions only the bed compartment and this at a cost of but a few cents for each hot night. The original cost is only a small fraction of that of an air conditioning unit for an entire room that can give no more comfort—if as much. In the Coolrest, Crosley has placed what was once the rare luxury of the rich within the means of the masses... giving you a mass market and a mass profit.

Average people cannot afford to escape to the North Woods. Electrical air conditioning for the bed-room is far beyond their reach. So they toss and turn, swimming in perspiration.

In the Coolrest, Crosley gives you the answer to the question: "Is there no escape from this awful heat?" This inexpensive, attractive, quiet, and amazingly efficient device electrically air conditions the sleeping compartment over the bed. It not only cools, but also removes excess moisture from the atmosphere, re-circulating and purifying the air so that it is actually as cool, fresh, and pure as that of the North Woods.

For Hotels and Hospitals  
Few hotels have air conditioned rooms. Hotels will buy the Crosley Coolrest for renting to guests who want comfort on hot nights. The hotels might charge, say, a dollar extra each day the Coolrest is used. In a season it will largely pay for itself. And what an advertising advantage for the hotel—and you!

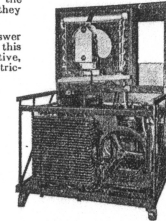

The unit is as quiet as a small electric fan... It is famous for trouble-free performance.

"Air conditioned sleeping compartments by means of the Crosley Coolrest Air Conditioned Bed Canopy!"

And hospitals—doctors agree that physical comfort for a lot of work with recovery. Every hospital ought to have a number of Crosley Coolrests for patients who get it in hot weather. This is a market easily sold—for here the Coolrest will be a self-paying proposition.

Package Sale—No Installation Problem  
Any householder can put up the Crosley Coolrest in a few minutes. The air conditioning unit is housed in a handsome cabinet of rare woods and the canopy is suspended from fixtures attached to the cabinet. When making the bed, the whole unit is simply rolled away and then pushed back to the bed.

### Easily Demonstrated

Display a Crosley Coolrest on your floor or in your window. Have it set up and working. Invite your customer to go inside and lie down for a few moments and to note the refreshing coolness and purity of the air. Demonstrate how it may be controlled while lying down; how canopy may be pushed away and pulled back as easily as one throws a blanket aside or pulls it up. Then sell it as a package—as you would a Crosley Radio or Sheldor Electric Refrigerator. This is a rare opportunity for you to get in on a ground floor proposition. See your Crosley distributor.



Should the Crosley Coolrest not be needed you can flip back the canopy as easily as throwing a blanket aside.



The Coolrest Air Conditioned Bed Canopy does not interfere with making bed. Just flip the canopy back or push the entire unit away.

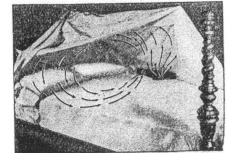

Cool, purified, and dehydrated air enters gently and quickly, circulates throughout the bed compartment, and is withdrawn through rectangular opening at left.

## The Crosley Radio Corporation - Cincinnati

(Pioneer Manufacturers of Radio Receiving Sets)

Home of "The Nation's Station"—W1W—500,000 watts—most powerful in the world—70 on your dial  
POWEL CROSLLEY, Jr., President CINCINNATI

RADIO FOR JULY