

$$E = I \times R$$

$$R = \frac{E}{I}$$

$$I = \frac{E}{R}$$

CONDENSERS IN SERIES

$$C_{TOTAL} = \frac{C_1 \times C_2}{C_1 + C_2}$$

RESISTANCES IN PARALLEL

$$R_{TOTAL} = \frac{R_1 \times R_2}{R_1 + R_2}$$

RADIO

ESTABLISHED 1917

SHORT-WAVE AND EXPERIMENTAL

BOTTOM VIEWS OF SOCKETS

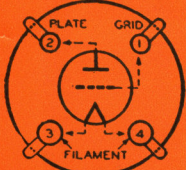

4-PRONG SOCKET
50-201-A, 45, 210, 30, 31, ETC.

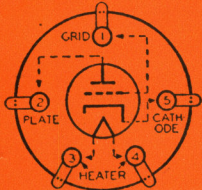

5-PRONG SOCKET
56-46-47-76-27-37

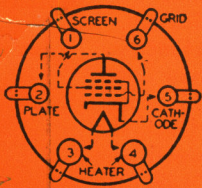

6-PRONG SOCKET
2A5-41-42-43

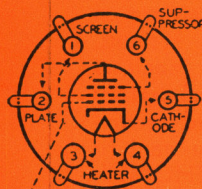

6-PRONG SOCKET
57-58-606-606-77-78

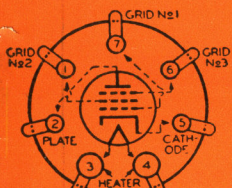

7-PRONG SOCKET 59

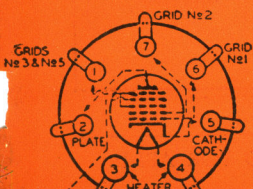

7-PRONG SOCKET
2A7-6A7

- IN THIS ISSUE -

- ★ A Practical Controlled Carrier Transmitter
- New Crystal Filter and B. F. O. Circuit
- The Variable Carrier Linear R. F. Amplifier
- "222" Receiver With Modern Improvements
- Economy Two-Tube High-Output Transceiver
- Comments on Avoidable Tube Failures
- A Linear Rectifier for the Phone Operator



The illustration shows a Controlled Carrier Transmitter which has been on the air in New York City during recent weeks. An interesting report from W2HMD says: "Impossible to receive you with standard carrier. All I can get is a terrific heterodyne. But you come through perfectly with controlled carrier and with broadcast quality. Not a sign of interference." Thus another new chapter in radio history is written.

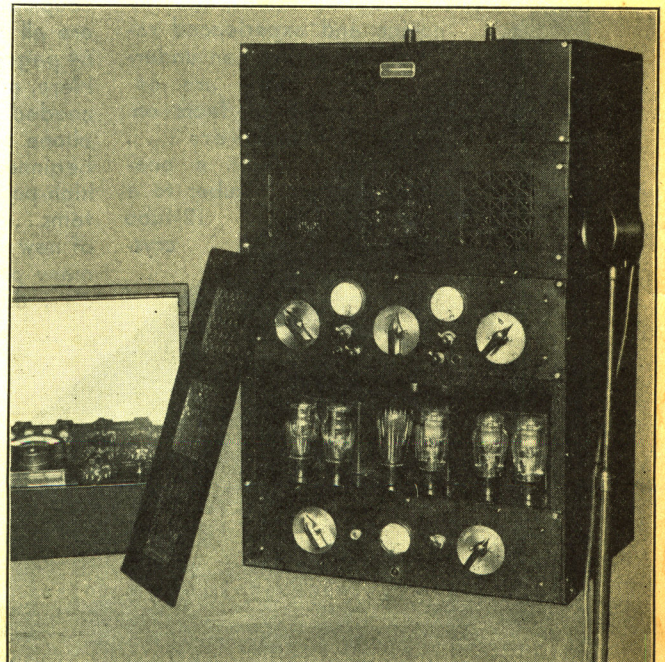

FEATURE ARTICLES BY ...

FRANK C. JONES
W. W. WAHLGREN

I. A. MITCHELL
J. N. A. HAWKINS

COL. C. FOSTER
HERBERT RUSS

A HANDBOOK

By

"RADIO"

NOW
on the
PRESS!

—Newer
—Bigger
—Better

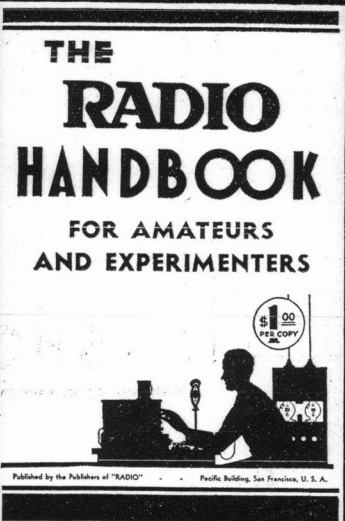

A New Authority for the Radio Amateur **THE "RADIO" HANDBOOK**

\$1.00
per copy

Postpaid anywhere in the U.S.
\$1.25 in Canada and in
Foreign Countries.

It Required Two Years to Write This Book

HERE is the book you have waited for... a Handbook by "RADIO." New as tomorrow. Chock-full of the kind of information you don't find in other books. The work of a group of experienced amateur radio engineers who know what you want. Frank C. Jones, W. W. Smith, Jayenay Hawkins, Clayton F. Bane, I. A. Mitchell, D. B. McGown... are the men who were assigned the task of writing this modern handbook, one the novice and experienced radio man alike can understand. There are 64 pages of facts on receivers... from a one-tube to a 12-tube crystal-

tal superheterodyne, with complete information on the engineering, design, construction and operation of each. You will find ANY high-frequency receiver of your choice described in this book. Each receiver is the best in its field. Then there are 64 pages of new facts on CW transmission, showing how to design any kind of a transmitter from a one-tube for beginners to a de luxe 1 KW high-efficiency transmitter. The many new methods of neutralizing, antenna coupling, low-C tube operation, etc., are all described in this great book. 64 pages devoted to Radiotelephony. Here, again, you find the information needed for building any kind of a phone set from the single-tube for beginners, to the 1 KW job for the high-power man. New modulation systems... all the data on various types of new controlled-carrier systems... many pages of new microphone data... theory of radiotelephony, etc.

Everything is explained, step by step. You cannot go wrong if you use this book as your guide to better radio. And another 64 pages devoted to ultra-high frequency communication, showing everything of importance... many kinds of transceivers, new Jones superheterodynes, diathermy applications, etc. Last, but not least, the antenna chapter is alone worth the price of the book. It is COMPLETE! Tells how to tune all types of antennas for best results. Gives tables, charts, curves, etc. The chapters on transformer design, audio systems, rectifier and filter design, monitors and frequency meters, laboratory equipment, transmitting and receiving tubes tell you what you want to know. Here is your new AUTHORITY. \$1.00 per copy.



**Dealers,
Jobbers and
Agents Wanted
Everywhere—Attractive
Proposition for Wholesalers—**
Library Bureaus Are Invited to Write for Complete Details

Deliveries Within 30 Days

SEND YOUR ORDERS TO

"RADIO"
PACIFIC BUILDING
SAN FRANCISCO, CALIFORNIA
U. S. A.

HAMMARLUND

Transmitting and Receiving

CONDENSERS

NOTHING so clearly typifies Hammarlund thoroughness in design and workmanship as the new Hammarlund line of fine condensers for every radio purpose.

Hammarlund Condensers have been famed throughout the world since the beginning of radio broadcasting.

Study the illustration of the new Dual Transmitting Condenser (*below*) and you'll see that both the frame and plates are "oversize." That means greater rigidity, freedom from vibration and assures absolute steadiness of signal.

Heavy aluminum ends shield the condenser thoroughly. Four sturdy duralumin posts tie these plates together. Further reinforcement is provided by the Isolantite insulating cross-bars.

Plates are wider-spaced than usual and have rounded edges which permit greatly increased voltages. Smooth bearings; self-cleaning contacts. Whatever your condenser needs, consult the Hammarlund catalog *first*.

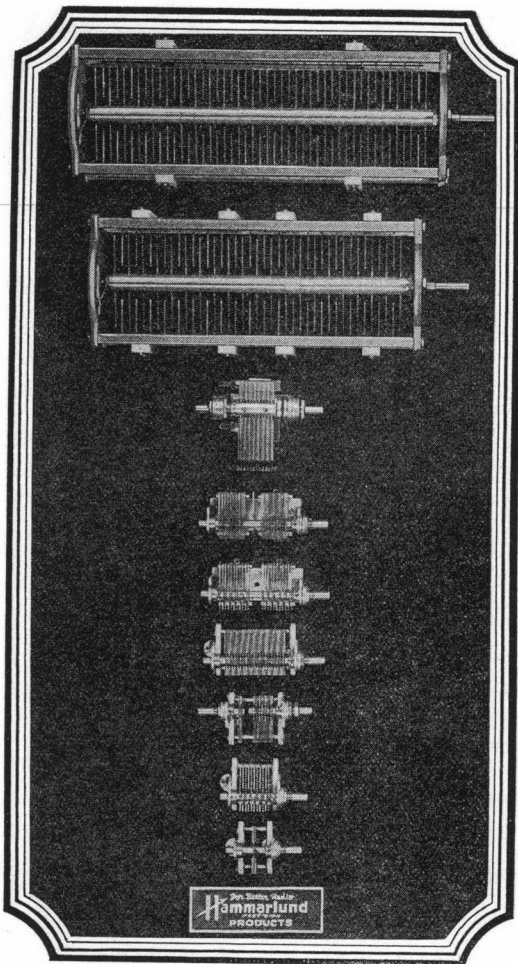

New DUAL Transmitting Condenser

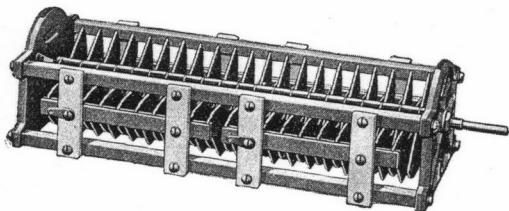

Hammarlund Dual Transmitting Condensers incorporate all features described above. With a stator connected to each side of the coil, the rotor of the condenser is at ground potential. This permits mounting the condenser on a metal panel without insulation and eliminates the probability of r.f. burns through the condenser handle. Hand-capacity effects are also greatly reduced. Five capacity ratings per section (100 to 500 mmf.) are available. List prices, \$9.00 to \$18,00, less 40% to experimenters.

Canadian Office:
41 West Ave. North,
Hamilton, Ontario

Mail Coupon for
Catalog



HAMMARLUND MANUFACTURING CO.,
424-438 W. 33rd St., New York.

- Check here for details of new variable-coupling I.F. Transformer.
- Check here for FREE General Catalog.
- Check here and attach 10c for new 32-page Hammarlund Short-Wave Manual, illustrating and describing most popular S-W circuits of past year, with schematic and picture diagrams and parts lists.

Name.....

Address.....

PR-4

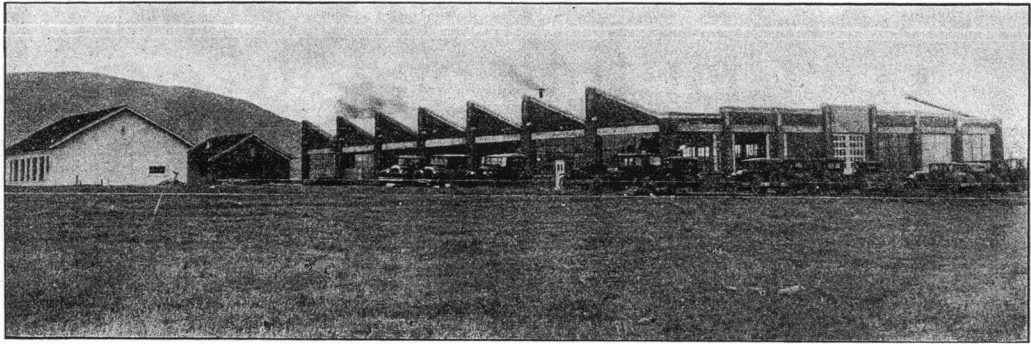

First Determine What's Behind the Product Before You Buy!

The New Improved HK 354 Gammatron

TAKE no risk! You cannot afford to experiment when purchasing high-power transmitting tubes.

You must know in advance that you are getting value for your money, that the guarantee behind the tube means what it says. You want to know that your tube was engineered by men who have spent a proverbial lifetime in the design of just ONE line of tubes . . . tubes for your transmitters. The HK-354 GAMMATRON is the ace among transmitting tubes. For behind it is a pedigree . . . 20 years of sound engineering, painstaking care to see that only the finest tubes leave the factory. You do not experiment when you buy an HK-354 GAMMATRON. Here is a tube that will convert your input power into radio frequency power more efficiently than any other tube on the market. A tube capable of handling one kilowatt input for your C.W. transmitter.

Behind this HK-354 GAMMATRON is the Heintz and Kaufman factory, utilizing over 40,000 square feet of floor area. It is a sound establishment. Here the finest transmitting tubes are made, and supplied to large maritime and commercial communication companies. The engineering skill behind the HK-354 GAMMATRON is proved in practice by the hundreds who now have these new tubes on the air. Ask any amateur who uses a HK-354 GAM-

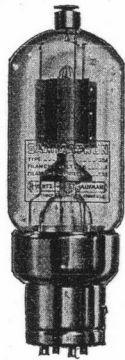

150 Watt Plate
Dissipation
High Mutual
Conductance
High Out-Put
Easy to Excite

Write for
Engineering Bulletin

MATRON. Let him tell you how easy it is to excite . . . how rugged its construction, how efficient its operation.

In the HK-354 GAMMATRON you find a Tantalum plate, most costly plate material known. The envelope is made of NONEX glass, hardest, finest for high-power tube design. The plate and grid supports are original, as is the massive base and socket structure. The filament is a husky one, 5 volts at 10 amperes, rigidly supported maintaining a high uniformity of characteristics.

HK-354 GAMMATRONS are built to STAND UP. It took years to perfect this tube. It requires expensive and special manufacturing equipment. In the Heintz and Kaufman plant where these tubes are made, the most exacting engineering and manufacturing methods are maintained. Every HK-354 GAMMATRON is PERFECT when it is shipped to your dealer. The immediate success which this tube has attained is the talk of the better amateurs everywhere.

Want a testimonial? Ask the fellow on the air what he thinks of the HK-354. You will never be satisfied with anything less. The price . . . \$24.50 net. Leading amateur supply houses stock the HK-354 GAMMATRON. Go see them!

These Authorized HK Dealers Have the 354 in Stock

BOSTON, MASS.
The Radio Shack, 46 Brattle Street

CHICAGO, ILLINOIS
Mid-West Radio Mart, 520 So. State St.

SAN FRANCISCO
I. S. Cohen's Sons, 1025 Market Street
Zack Radio Supply, 1470 Market Street

OAKLAND
Electric Supply, 51 - 12th St.
E. C. Wenger, 1020 Oak St.

SPOKANE, WASH.
Spokane Radio Company, Inc., 611 1st Avenue

PORTLAND, OREGON
Stubbs Electric Company, Park and Couch Streets

ST. PAUL, MINN.
Lew Bonn Company, 2484-2486 University Avenue, Midway

NEW YORK, N. Y.
Wholesale Radio Service Company, Inc., 100 - 6th Avenue

YOUNGSTOWN, OHIO
Ross Radio Company, 46 E. Federal St.

NEWARK, N. J.
Kalter & Romander, 62 Court Street

LOS ANGELES
Pacific Radio Exchange, 729 South Main Street
Radio Supply Company, 912 South Broadway

SEATTLE, WASH.
Seattle Radio Supply, 2319 2nd Avenue
Northern Radio Company, Joseph Vance Bldg.



SOUTH SAN FRANCISCO, CALIFORNIA

RADIO

ESTABLISHED 1917

Reg. U.S. Pat. Off.

A NATIONAL MAGAZINE - PUBLISHED MONTHLY

Publication Offices—Pacific Building, San Francisco, California

Clayton F. Bane, Editor

H. W. Dickow, Business Manager.

D. B. McGown, Technical Editor.

Frank C. Jones, Ultra-Short-Wave-Engineering Editor.

Clair Foster, Amateur Activity Editor.

George B. Hart, Contributing Editor.

C. C. Anderson, Engineering Draftsman

BRANCH OFFICES:
New York City,
253 W. 128th St.
Tel. MOnument 2-2812
Boston,
J. H. Condon,
6 Marlboro St.
Chicago,
C. W. Nelson,
3618 North Bernard St.
Los Angeles, Calif.
1455 Glenville Drive.
Tel. CRestview 4017

25c per copy, \$3.00 per year by subscription in the U.S. \$4.00 elsewhere. Send subscriptions to the San Francisco office. Entered as second class matter at the Post Office at San Francisco, California, under the Act of March 3rd, 1879.

Vol. 17

APRIL, 1935

No. 4

Radiotorial Comment

Did You Bite?

THERE are tricks in every trade. Not so long ago an advertisement was published which read: "Send Dollar Bill and We Will Mail You a Beautiful Engraving of George Washington." A post office box number was used for the advertiser's address. And what do you think the purchaser received in the form of a "beautiful engraving?"—he received a two-cent U. S. postage stamp bearing the portrait of the Father of our Country! Unquestionably, the promoter of this racket cleaned up. It is said that great difficulty was encountered in putting a stop to it because his "business" was literally above the law.

And so it is with the radio racketeer—one who sends postcards to licensed radio amateurs and tells them this story: "Dear Sir—We have a clipping from an American Magazine in which you are mentioned by name and we think it should interest you. We shall be glad to forward same with data on receipt of 25 cents in stamps. Yours very truly, The John T. Manners Co., 609 Fifth Avenue, New York City."

In a recent issue of QST a similar racket was exposed, but the racketeer made his hide-out on the Coast, not in New York City. The writer received one of the postal cards from The John T. Manners Co. and another was received by reader Wm. O. Canady of Los Angeles. It is understood that many other amateurs are also in receipt of a similar card.

John T. Manners Co. (if you are a company), let me tell you what I think of your scheme. I believe you borrowed (or bought) a copy of the Citizens Radio Call Book . . . or some other list of radio amateur stations . . . that you are clipping names from it—that you send names clipped from it to the unsuspecting suckers who send you 25 cents in stamps. You fooled my young son when he read your sucker card. He thought his father's name had been mentioned in the American Magazine. And you probably fooled a lot of other boys.

I'm almost sure you got my name out of the Call Book, because it carries the only published record of my present home address. And I wouldn't send you 25 cents for a two-line clipping of my name, address and call letters, because I already know them by heart. Furthermore, "Chief" Stimson who publishes the Call Book in Chicago is an old friend of mine, and he sends me a copy of each issue without cost. So you lost two bits on me.

I was rather scorched when I received your card, John. So I sent it to my New York manager. I told him to walk into the stately offices of John T. Manners Co. (if

you have an office), ask for John himself—tell you (if he met you) that he received one of your cards. I then told him to plunk down his quarter and ask for the clipping. If, by chance, it proved to be a clipping of the name, address and call letters, taken from the Call Book, I told my New York manager to wind up his right arm, "tap" you fairly and squarely between the eyes, then wire and tell me how much bail money he needed to get himself out of jail on a battery charge, in the event you had him arrested. I don't believe there's a judge in New York City who would book him for more than 25 cents bail, the same amount you ask for that American Magazine "clipping" service of yours.

It strikes me that it wouldn't be a bad idea for the radio amateurs to petition the United States Supreme Court to release Al Capone. When he took our 25-cent pieces away from us he at least gave us a good 5c glass of beer in return. His profit was only 400 per cent. What's yours, John? And I wonder how you are going to list that "sucker money" in your next year's income tax report?



More Post Cards

WHILE we are on the subject of postcards, some of us wonder why the news-stand edition of the March issue of QST has between its pages a heavy-stock mailing card on which the magazine reader is asked to indicate whether or not he is a licensed radio amateur. Some time ago the radio amateurs, assembled in Pacific Division Convention, resolved that a membership count of the League be made and that the findings be disclosed within 60 days. The Convention was held in November.

Later the suggestion was made that the League send a double post card to all its MEMBERS . . . that the return portion, postage-paid, be returned to headquarters, and on this return card the MEMBER could state whether or not he is a licensed U. S. radio amateur. Obstacles were thrown in the path of this simple, direct and economical method of securing a count. The cost would be prohibitive, it was said. Yet 20,000 double post cards would cost but \$400. Suppose, for example, 20,000 QST readers who buy the magazine on the news-stand send the postage-guaranteed card (as inserted in March QST) to headquarters; it would cost the League \$600 for the return-postage-guarantee, or \$200 more than the MEMBERSHIP survey by double-post card mailing would have cost. If you don't quite get the point, read that last paragraph again.

If the League is willing to guarantee the postage on the cards which are inserted in March QST, why did it refuse to adopt the original plan to send a card to all of its present MEMBERS?

If the original \$400 plan was prohibitive, why is a substitute plan adopted which may cost the League \$600? Those who have been fighting for an accurate count of the number of U. S. licensed radio amateurs who are MEMBERS of the League will have no difficulty in answering the question.

And the \$600 plan does NOT give the information asked for at the recent Pacific Division Convention. The only information the amateurs wanted was the number of licensed U. S. radio amateurs who are MEMBERS of the League.

Are we going to get another of those long-drawn-out volumes of statistics which tell us everything but that which we want to know?

When the directors meet at Hartford in May, it wouldn't be a bad idea for some of the progressive radio club leaders to demand that their director bring back with him a complete statement of facts as to whether or not the FCC is actually making a membership survey for the League, or if, as has been said, the League has a group of its own people at work in the FCC offices for the purpose of gathering the needed information.

Likewise, it seems opportune for some group to instruct its director to bring back with him a sworn copy of the stenographically-recorded minutes of the forthcoming board meeting, so that those who pay to keep people in office at Hartford will be given the opportunity to at least know what the bosses talk about when directors meet. Let's get a report, for once in our lives, of the entire word-for-word procedure of the board meeting.

And will one of the true, tried and proven directors please bring back with him an answer to this question—"Will the League demand of our Congressmen that amateur radio privileges be not only protected—but widened at the Cairo Convention?" Another question: "Will the League join in our campaign to secure amateur representation on the FCC?" And another: "For what reason does Mr. Warner object to making the League wholly-licensed-U. S. Radio-Amateur in its makeup?" "RADIO" has given you its reasons; now let Mr. Warner give his.

The political pot has been boiling merrily since last the directors met. Let's call for a show-down at the May board meeting! Send your director a list of the questions you want answered. But make sure to instruct him to bring back the right kind of an answer, not an alibi.

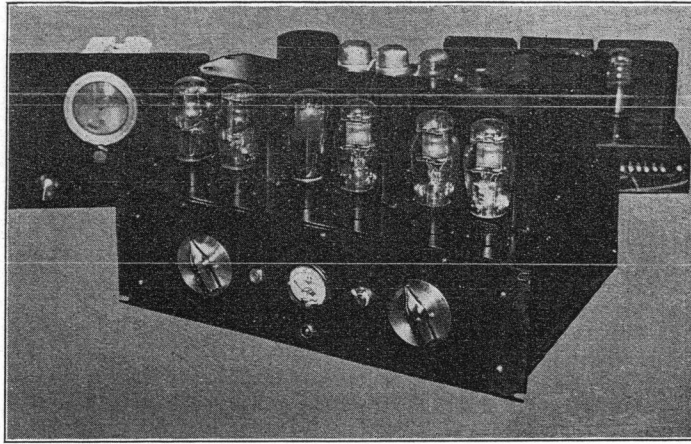

FIG. 2
The audio deck of the
controlled carrier
transmitter.

A Controlled Carrier Transmitter

By I. A. MITCHELL*

● For the benefit of those who did not read the writer's article on controlled carrier modulation in the last issue of "RADIO", let us summarize and further explain the characteristics and benefits of this system. Two major effects are obtained through the use of controlled carrier modulation; high percentage modulation is obtained at all levels, and the average carrier varies in magnitude with the audio output. These characteristics effect a number of improvements:

(a) Greater DX possibilities for the amateur, or greater blanket coverage for the broadcast station. This is caused by the high percentage modulation at low levels. As the integrated audio output of a transmitter rarely exceeds 10 per cent of its rated maximum output, this becomes a very important point. The theoretical side of this phase of controlled carrier modulation indicates that it is possible for a small station using this system to obtain the same coverage at a station many, many times larger and with less interference. This increase in effective comparative power is so great that the actual magnitude will not be mentioned until further tests have proven that past theory actually agrees with practice. (The actual theory and calculations for this appear under "Increased Working Range" in last month's article).

(b) Increased tube economy. Due to the fact that the Class C input is low for the major part of the time, an effect similar to Class B is obtained, permitting much higher output from a given tube arrangement. Hawkins, who is an authority on transmitting tubes, states that a pair of 45s with controlled Class C input can deliver 35 watts of equivalent effective carrier.

(c) Reduction in interference. This is of extreme importance to both the amateur and the broadcast station. Because the carrier level is low for the major portion of the time, interference and "monkey chatter" is reduced. To the broadcast field this means a definite step toward high fidelity, as the high frequency range of radio receivers could be extended without the present background noise caused by monkey chatter. To the amateur this means a much less crowded ether.

(d) Due to the low power taken by the final for the major part of the time, there is a definite reduction in power consumption. If the tubes are not operated too hard, an increase in tube life is obtained.

(e) Higher fidelity is possible from the

broadcast station from the standpoint of volume range. One of the factors controlling volume range from a transmitter is the fact that when the audio level drops very low, the modulation percentage decreases as the square of this audio drops in level. This results in poor and possibly no reception at the receiving end. A higher percentage modulation at low levels would tend to overcome this difficulty, and permit the transmission of wider audio volume ranges.

(f) If high power output is required, the controlled Class C can be fed into a Class B linear. The power rating of output tubes operated in this manner is practically quadrupled. The tubes operate efficiently to begin with, due to Class B operation. To this is added the fact that the plate dissipation from the Class B tubes is almost negligible at no signal input. As the audio level varies, the Class C input is varied and this varying input being applied to a Class B stage permits the plate power input of the Class B stage to vary over a wide range. A further benefit of this system is the fact that modulation need not be done at very high level. A 500 watt station need only

have 50 watts of audio output. This modulates a corresponding Class C tube which drives the 500 watt Class B linear. If still further power is desired, the Class B linear can be fed into another Class B linear. J. N. A. Hawkins who brought up this angle of controlled carrier furnishes further details in an article appearing elsewhere in this issue of "RADIO".

Before going into the constructional details of a transmitter of this type it is of interest to note the results of the first test on the air of the transmitter to be described. M. Joffe (W2BNY), who arranged the RF layout and who is responsible for the mechanical construction of this model transmitter, was at the Brush High Fidelity microphone. G. Korper (W2HMD) was at the receiving end. A switch is provided on this transmitter to permit immediate changeover from standard to controlled carrier. This first test was intended to confirm on the air the original laboratory tests which had indicated no increase in distortion from the use of controlled carrier. After thirty minutes of operation with the switch thrown alternately to standard and controlled carrier, the following report was received from W2HMD:

"Impossible to receive you with standard carrier. All I can get is a terrific hetero-

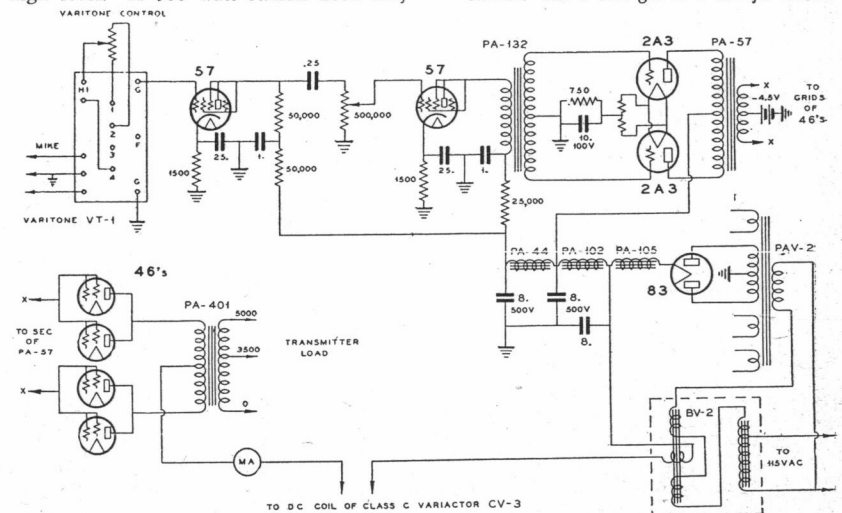

FIG. 3. Complete Circuit of the Audio Channel of the Controlled Carrier Transmitter.

* Chief Engineer, United Transformer Corp.

dyne. But you come through perfectly with controlled carrier and with broadcast quality. Not a sign of interference."

This more than answered our expectations. From the angle of interference we were not only reducing the crowding of the ether so that we would not interfere with somebody else's signal, but reduced interference was permitting our own signal to get through!

Fig. 1 illustrates a complete transmitter using controlled carrier modulation. The audio amplifier is at the bottom of the rack. Above it is the RF, and the very top panel (which in the picture happens to be blank) carries the Collins antenna network. Through the use of special circuit details described

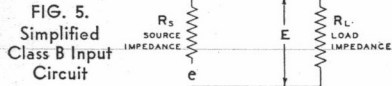

below, 70 watts of audio is obtained from four 46s in Class B, without excessive distortion. This output is used to plate modulate a pair of 801s in controlled Class C, with 140 watts maximum controlled Class C input.

Fig. 2 illustrates the general appearance of the audio amplifier alone, and Fig. 3 shows the complete electrical circuit of this audio unit. A number of unusual circuit features are incorporated in this amplifier. The input transformer is of the Varitone type. As is well known, the intelligibility of speech is not affected appreciably if the frequencies below 300 and above 3000 are cut off. However, if these frequencies are cut off, a considerable decrease in the average power is produced. Inasmuch as the plate input of both the audio and RF output tubes is proportionate to the power, a considerable saving in power consumption and a still greater increase in tube life can be effected by cutting off these non-essential frequencies. Fig. 4 illustrates the comparison of audio response and power with and without the Varitone control. The left control on the audio panel varies this audio response from a minimum to a maximum. On the other hand, if extreme high fidelity is desired, the Varitone unit can be connected to increase both low and high frequencies to compensate for frequency discrimination in the microphone, etc. The input of this Varitone transformer has both

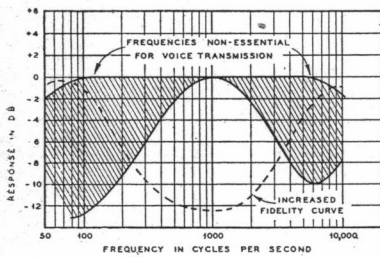

FIG. 4—Maximum effect of varitone on amplifier. Shaded area represents saving in power. Dotted line represents frequency response with varitone set for high fidelity compensation.

a center-tapped low impedance winding for a mike or line, and a high impedance winding to couple the plate circuit of a tube if an additional audio stage is added to take care of a low-level velocity mike. One of the new Radio Receptor dynamic mikes was used for some of the tests on this rig and it was found to be excellent both from the standpoint of level and mechanical ruggedness. The new microphone is seen in Fig. 1 at the right of the transmitter. It has a 50 ohm impedance and was found to work quite well

directly into one-half of the low impedance winding of the input transformer. The first tube in the audio amplifier is a 57, triode connected, and resistance coupled to another 57, triode connected. This second tube is transformer coupled to a pair of 2A3s which in turn drive the four 46 output tubes. It is well to note here the fact that 2A3 tubes are far superior to most other tubes for use as Class B drivers. This is most evident from an examination of a simplified schematic (Fig. 5) of a Class B input circuit.

For low distortion it is necessary that the voltage E (applied to the Class B grids) be directly proportional to the voltage e from the driver. At low signal voltage the Class B grid impedance is very high, so that it represents practically all the resistance in the circuit R_L plus R_S , resulting in $E = e$. The distortion generated is proportional to the discrepancy between E and e and in turn

bears a relation to the ratio of $\frac{R_L}{R_S}$. When $\frac{R_L}{R_S}$

equals infinity, we have a perfect voltage transfer. Due to the fact that R_L (the Class B grid resistance) varies with level, to keep

the ratio $\frac{R_L}{R_S}$ high, it is necessary to keep R_S

low. R_S consists of the reflected tube impedance and the transformer loss impedance. The transformer loss impedance can be kept at a minimum at all frequencies through proper design. However, the tube impedance can be predetermined. If a 59 triode is used, the original tube impedance is 2400 ohms (plate resistance). On the other hand, the 2A3 tube has a corresponding impedance of only 700 ohms. This means that for the same variation of E to e , the Class B grid can be driven to $3\frac{1}{2}$ times lower resistance using 2A3s as drivers as compared to 59s as drivers. This in turn represents a higher power output for the same grid distortion.

While using 2A3s and a proper input transformer gives plenty of driving power for our Class B tubes, there is one further limitation to high power output with low distortion, namely, plate supply regulation. No standard plate supply has perfect regulation, particularly at maximum audio peaks when the plate current of Class B tubes runs extremely high. A novel adaptation of the variator can be used to compensate or overcompensate for this regulation. The application of this is illustrated in the amplifier circuit of Fig. 3. A small auto-transformer and variator is applied to the primary of the audio amplifier power transformer. This is so arranged that the plate current of the Class B tubes saturates the series reactor and increases the power transformer secondary

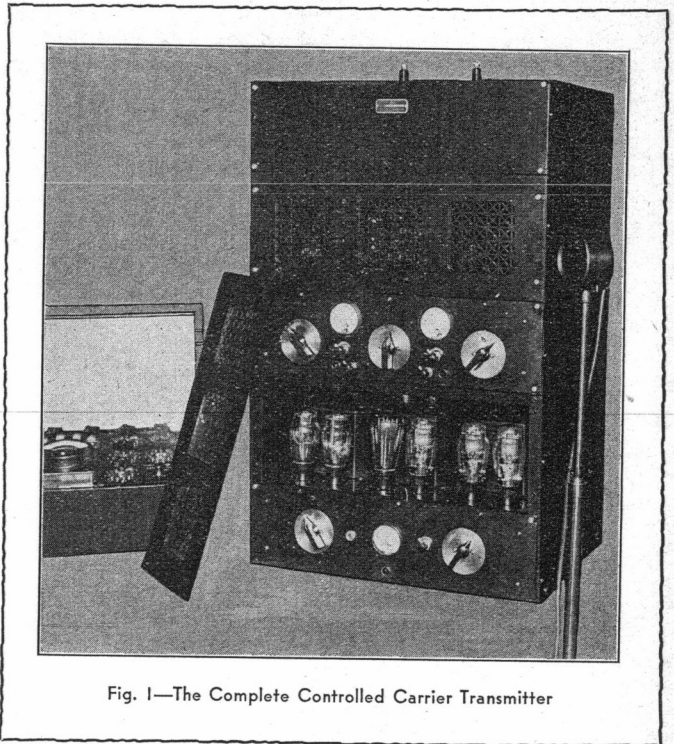

Fig. 1—The Complete Controlled Carrier Transmitter

voltages as the plate current is increased. This compensation is arranged in the transmitter shown so that a 5 per cent increase in plate voltage is effected at the Class B plates at maximum output. In addition, at these peak powers the filament voltage is somewhat increased so that additional filament emission is obtained to take care of the peak plate current. An increase of at least 25 per cent in power rating has been checked so far. More definite figures on distortion and output will appear in "RADIO" in an early issue. The result is that two simultaneous effects take place tending to increase the power handling ability and reduce the distortion. The plate voltage is maintained constant and the filament emission is increased at peaks so that distortion due to emission saturation is minimized. Furthermore, the tendency for motorboating and degeneration caused by the plate voltage on the first stages varying with output is eliminated. This combined autotransformer and variator for Class B audio is quite compact. For the 70 watt transmitter shown, the size of the complete control unit is only $1\frac{3}{4}$ -in. x 3-in. x 6-in.

The balance of the audio circuit is more or less standard. Four 46s in the audio output are matched to a transformer having a tapped output winding. A plate milliammeter is supplied to check level. To reduce the initial plate current, a $4\frac{1}{2}$ V. C battery is used into the 46 grids. On the panel shown in Fig. 2, the control to the right is volume; to the left, frequency range. The switch controls the power supply and a bull's eye is provided. The mike plugs into the jack on the left. The rectifier and low level tubes are at the back of the chassis and the driver and output tubes at the front. The Class B variator unit is underneath the audio chassis. No autotransformer is used for the variator circuit for the RF as the Class C plate transformer has an 85 volt tap. This variator unit is mounted under the RF deck.

Due to space limitation, further details on the RF and other characteristics of this transmitter will have to be saved for the next issue of "RADIO".

The Variable Carrier Linear Amplifier

★★★Two to Four Times the Output Obtained From Conventional Linear Amplifiers

By J. N. A. HAWKINS

ELSEWHERE in this issue is an article on the radically new Controlled Carrier Modulation System of Mr. I. A. Mitchell. He describes a means of obtaining the voice controlled variable carrier in a plate modulated class C amplifier whose plate voltage is varied in accordance with the syllabic variations in the transmitted speech. In working with this and other systems of

really high plate efficiency to be obtained from the class B linear.

The class B linear RF amplifier follows a controlled carrier class C stage whose maximum equivalent effective carrier output is about 50 watts.

the grid current on the linear amplifier is low.

The adjustment of the linear amplifier is simplicity itself. Tone modulation is applied to the audio channel until the class C stage is modulated just under 100 per cent.

The linear amplifier is then adjusted for maximum antenna current. The bias on the

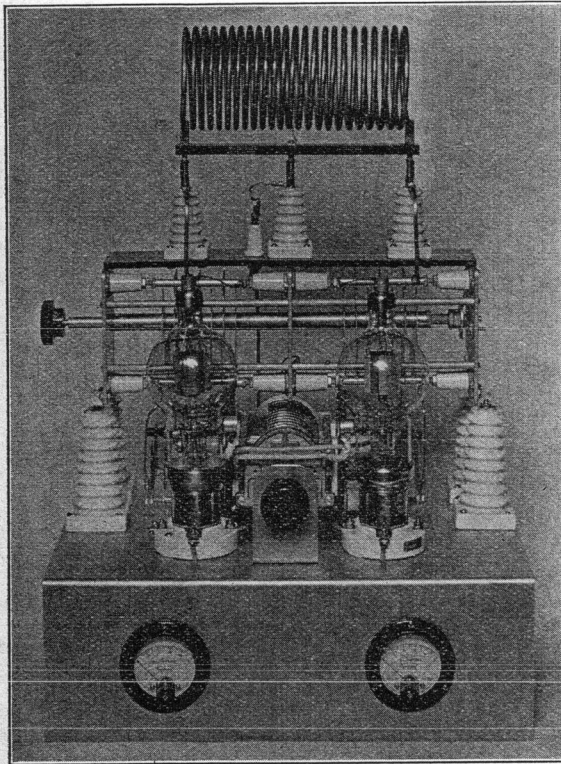

Two
Highly-
Efficient
1 KW
Amplifiers
for
Linear
Operation.

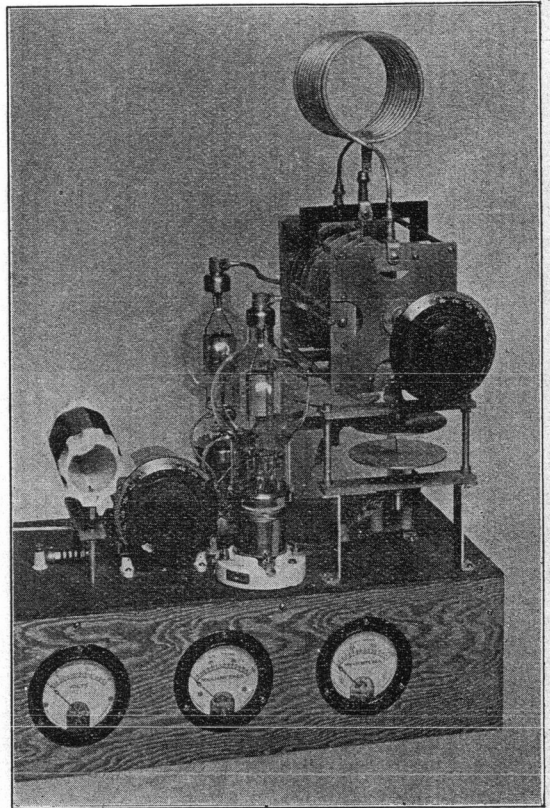

variable carrier phone transmission, the phone staff of "RADIO" has developed a high power final amplifier which follows the controlled carrier class C modulated stage and which allows the equivalent of a 500-watt carrier to be obtained with only a pair of 150Ts or HK354s used as a class B linear amplifier. It is impossible to present the entire story with complete details in this issue, but full details will be shown next month.

It seems that the old class B linear amplifier will again become widely used, now that Voice Operated Carrier Control allows

The circuit diagram of the final amplifier is here shown. It is a conventional push-pull, series-fed circuit, except for the grid loading resistor.

As the grid current drawn by the linear amplifier varies with the output of the class C stage, the load reflected by the linear amplifier also varies, over each modulation cycle. In order that the class C stage will remain linear, it is essential that it work into as stable a load as possible. Thus it is necessary to provide some form of a non-inductive resistor to hold the class C stage down when

linear should be set and then left at the theoretical cut-off point, which is the same point as used in class B audio. The only point about which there will be any necessity for cut-and-try is the adjustment of the grid loading resistor. It should be tapped on the grid tank until from 33 per cent to 50 per cent of the output of the class C stage is dissipated in the resistor. This can be determined by watching how the DC input to the class C stage varies when the resistor is taken out of the circuit with the carrier control disconnected so that the class C stage operates at normal input.

The maximum output of the 150Ts or HK354s during periods of substantially complete modulation, is 750 watts . . . which is about equivalent to 500 watts of carrier and 250 watts of sideband power.

When no modulation is applied to the transmitter the grid excitation to the linear drops 'way down, and so does the DC plate input. The input with no modulation is about 150 watts and this figure can probably be reduced somewhat with further development.

The whole point is that the final amplifier acts just exactly like a class B audio ampli-

(Continued on page 35)

Circuit of a class B Linear R.F. Amplifier capable of 150 watts of effective carrier output with a pair of 50Ts, when following a carrier controlled class C modulated amplifier.

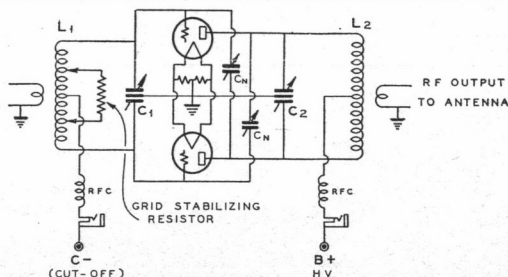

Colonel Foster's Comment

The New "Cairo Club of San Jose" (An amateur radio club concerned with nothing BUT "politics")

NAME: Cairo Club of San Jose.

PURPOSE: To take direct to members of Congress our request for the restoration of our rights and frequencies and the justification therefor.

Article I of the Bill of Rights of the constitution of the United States says Congress shall make no law abridging the right of the people peaceably to assemble, and to petition the government for a redress of grievances.

In conformance with this declaration the Cairo Club of San Jose will take direct to individual members of Congress the grievances of the 46,000 operators of amateur radio stations of the United States and the many thousands more who are being licensed each year.

The amateurs have grievances that only the Congress can remove. They developed the practical use of the short waves for communications after every commercial radio man and every physicist in the world had condemned the short wave as useless for this purpose. Since then the amateurs have been systematically deprived of their rights and channels by commercial people and their adherents. The commercial corporations now control virtually all of the air while the amateurs are permitted to use only an infinitesimal part of it.

The commercial corporations control a preponderance of the channels while they are putting to use in the service of the people only a small percentage of them. Already 46,000 amateur stations are confined in narrow bands incapable of accommodating 2,000 while employees of the government are issuing new amateur licenses at the rate of several more thousands each year for operation in these identical bands. No move has ever been made to restore to the people the channels now held by commercial corporations which have no use for them.

The corporations and their adherents are employing the devices of international commercial treaties whereby representatives of foreign countries now dictate to the United States government just what portion of the air the United States amateurs may be permitted to use. Each of these international conventions has left the citizens of the United States who are known as "radio amateurs" still further despoiled by the commercial corporations. The next of such conventions is to take place in Cairo, Egypt.

The amateurs of the United States are concededly a national asset. Besides their discovery and development of the short waves they constitute an absolutely necessary supply of trained technicians and operators in time of war. They perform a great public service at all times by the free transmission of messages. They handle thousands of messages a month for our own people in the Orient who are unable to pay the high charges exacted by the commercial communications corporations. They provide reliable communications in times of disaster when all other means of communication have been disrupted. The amateurs—all citizens of the United States—have invested millions of dollars of their own money in educating themselves and equipping their stations that are devoted to the service of the public and the service of the nation.

They are justified in demanding that Congress safeguard this investment and preserve this service.

The foregoing recital discloses the grievances for the redress of which the Cairo Club of San Jose will petition the government. The club will make proper presentation of the grievances and demands for the amateurs in the manner suggested in the Bill of Rights—by taking their case direct to Congress. Within the amateur ranks there are hundreds of men quite as talented and experienced as any in the employ of the government or the commercial corporations; the Club will insist that some of these amateurs be placed on the United States delegation to Cairo and that Congress INSTRUCT the delegation specifically as to the restoration of the rights and channels of the amateurs of the United States.

OFFICERS of the Cairo Club of San Jose: There shall be a President, a Vice President and a Secretary-Treasurer whose duties shall be those normally assigned to such officers. They shall hold office at the will of the members.

COMMITTEES: The responsibility for the appropriate conduct and action of the Club shall rest with the President; he therefore shall appoint such committees and assign such duties as his wisdom suggests. He shall re-arrange or discharge such committees in his own discretion.

MEETINGS: Shall be held at the call of the President.

DUES: Shall be assessed only as the Club needs them for conducting its business.

The foregoing arrangements shall be subject to alteration at any time at the will of a majority of the members.



Mama Cow, Papa Cow and the Little Bull

ON February 14 K. B. Warner, General Manager of the American Radio Relay League, told a large assemblage of Chicago amateurs that he would ask for more frequencies at Cairo. He didn't disclose what frequencies would be asked for, whom he would ask, or what would be done by the ARRL if the request were refused—as it surely would be.

In the "Tar Heel Ham" of the month before, the publisher of which is an ARRL director, Warner is quoted as writing the directors:

"Some of our friends in the communications administration at Washington are concerned about this determination of ours and endeavor to discourage us in our demand for more frequencies. They regard it as utterly impossible in the present stage of the world's intensive use of frequencies that they assert we shall only injure ourselves by such a demand. Their point of view is that the administrations have come pretty generally into the acceptance of the present amateur allocations as a sort of necessary nuisance to placate the United States and Canada, but that if we show we are discontented and demand more we put ourselves in the category of a danger that will have to be taken drastically in hand. They feel that, regardless of our numbers, the amateur service as a whole is not entitled to more than its present proportion of the total. I encounter again the suggestion, previously passed on to you, that we are not yet making the best possible use of our assignments and that we could

do much to reduce our interference problem by such devices as segregating beginners on probation, subdividing different frequency bands by private arrangements between ourselves by zones, etc. Of course, I counter that every amateur is entitled to exercise all of the amateur privileges, but I don't know but what there is a great deal to what they say. I think we could make a great improvement."

Which all sounds strangely like what occurred prior to the Madrid convention. The Canadian government then had determined to demand more frequencies for Canadian amateurs, but Warner wrote all directors that he had "canvassed thoroughly" the radio people and was convinced that if the United States amateurs demanded no more frequencies we would have the backing of the United States delegation, while if we asked for more we would not. It seems "our friends" are friends only so long as we comply with their wishes. On this theory we ought to have a pile of friends by now. This letter of Warner's was a call for a mail vote by the ARRL directors. It strongly intimated that a vote to ask for no more frequencies was in order, and the directors voted accordingly.

Now we are informed by Mr. Warner that the ARRL is going to break a long-established precedent and ask for something at Cairo. And the amateur paper that reports the Chicago visit of Warner lauds him to the skies and says the meeting gave him a rising vote of thanks and confidence.

All of which reminds me of the Big Mamma Cow and the Big Papa Cow who dwelt with their Little Boy Cow on a Connecticut farm not far from Hartford. The Little Boy Cow was given to wandering off by himself. This gave the Big Mamma Cow much uneasiness. At sunrise one morning she discovered that he was nowhere in sight. Waking the Big Papa Cow she dashed off madly in several directions all at the same time. The Big Papa Cow, being less excitable, picked up the tracks of the Little Boy Cow and followed them. Soon he bawled to the Big Mamma Cow and she hot-footed it to his side. He pointed out the Little Boy Cow away off on the opposite side of the valley. The Big Mamma Cow drew a sigh of relief clear from her fourth stomach. "Darling," she exclaimed, "doesn't it beat hell how far a little bull can travel!"



"POLITICS"

"WHEN you talk about getting more frequencies for the amateurs, that's not political; when you talk about firing Warner, that's political."

This pronouncement was made at a recent hamfest by a man who had just declared, "I can give you a definition." The requirement had been laid down by the promoters of a new amateur organization that it must be "non-political." Some of us had been trying in vain to get the promoters to say just what they meant by the term.

As a definition the quotation leaves much in doubt, but as a vivid expression of what is in the minds of those amateurs who inveigh against "politics" it is exact. When you hear an amateur excoriating politics you may safely bet that he is a Warner man. He always objects to any criticism of the acts of our great Spokesman for the Dispossessed.

"Politics" is nothing more than a discussion of policies. When there are policies that cannot stand discussion and criticism it is

(Continued on page 34)

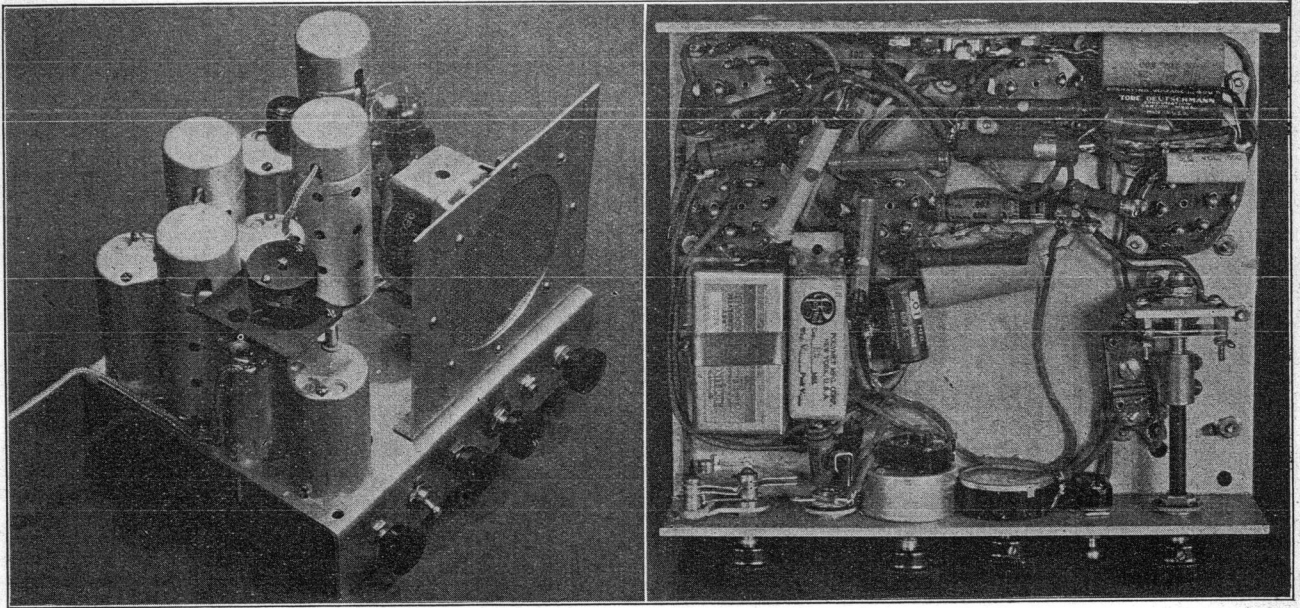

A simple, highly-efficient I.F. Amplifier unit incorporating the new B.F.O. and crystal filter circuit. The wiring diagram is the same as for the "222" receiver shown below.

A New Crystal Filter and B. F. O. Circuit

By FRANK C. JONES

• Crystal filter circuits are useful for increasing signal-to-noise ratio in superheterodyne receivers. By proper adjustment, the selectivity of a receiver with a crystal filter can be made so great that only one sideband is made audible and an approximate single-signal effect is obtained. Quartz crystals are useful as oscillators or resonators. In the latter case, the "Q" of the circuit is extremely high and thus the selectivity characteristic is much more sharply peaked than when ordinary circuits are used.

A quartz crystal acts as a large inductance, very small capacity and a resistance in series, as in any series-tuned circuit. At resonance, for about 465 KC, the capacity of a few hundredths of one micro-microfarad, cancels out the effective inductance of several henries, leaving only a resistance of a few thousand ohms. Slightly off resonance, the reactance of the extremely small capacity and very large inductance is so great that at either side of exact resonance the impedance is great enough to prevent signals passing through. In any quartz crystal filter circuit it is necessary to balance out or neutralize the crystal holder plate-to-plate capacity in order to make the resonance effect really function. In the circuit shown, this is accomplished by means of a 15 or 25 mmfd. variable condenser and a center-tapped IF tuned circuit.

The plate circuit of the first detector should be tuned for maximum signal gain and the plate coil tuning condenser acts as an effective RF bypass to increase detector efficiency. The center-tapped coil and neutralizing or phasing condenser form a Wheatstone bridge to balance out the crystal holder capacity. At resonance the succeeding tuned IF circuit would be over-coupled to the first detector tuned plate circuit, because effectively there is only a resistance of a few thousand ohms between the "hot" ends of the tuned circuits. This is prevented by means of a small coupling condenser, 3-30 mmfd. in value, in series with the crystal. This allows the use of tuned circuits between the crystal and first

IF amplifier grid without loss in signal. By this matching device there is no appreciable loss in the crystal filter when it is cut into the circuit. The noise level drops, because

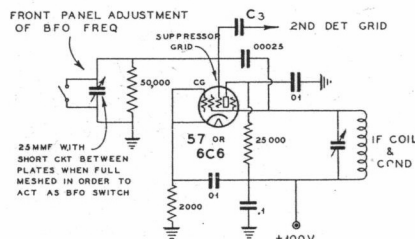

The new BFO Circuit as developed by RCA and applied to the "222" Receiver by Jones

the band passed through the IF amplifier is greatly narrowed down.

With an efficient circuit of this type, only one stage of high gain IF is necessary, which greatly simplifies the construction for an ama-

teur receiver. Any superheterodyne should have as much gain as possible in the front end, and not depend too much upon the IF amplifier for gain. The main function of the IF amplifier is to increase selectivity.

The particular advantage of this crystal filter is that it can be put into any existing superheterodyne receiver without disturbing

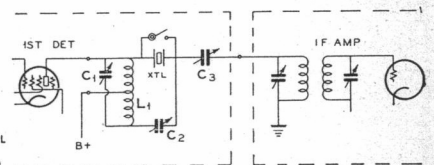

The new Jones Crystal Filter Circuit.

- L1—Hammarlund 2.1 mh. choke center-tapped.
- C1—8-70 mmfd. mica trimmer (or air cond.)
- C2—25 mmfd. var. air cond. (midget)
- C3—3-30 mmfd. mica trimmer cond.

the IF amplifier in any way, except to disconnect the detector plate leads.

The new B.F.O.—beat frequency oscillator circuit uses a relaxation type of oscillator. The advantages are in simplicity, since no

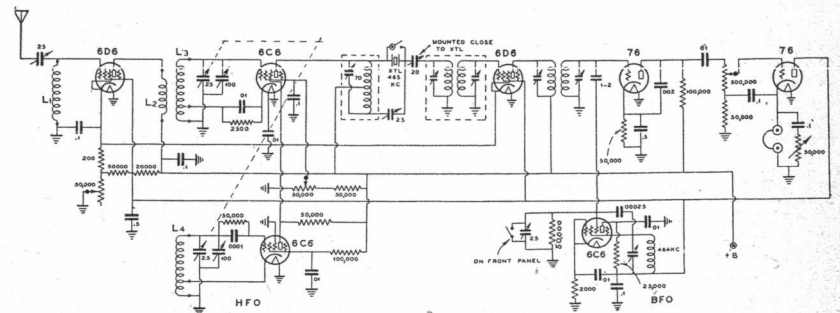

Complete Circuit of the Crystal Filter "222" Receiver. Coil winding data same as for previous models.

tickler or cathode tap is necessary in the tuned circuit. This form of circuit is quite stable and the harmonic content is usually less than in an electron-coupled B.F.O. These harmonics are heard in the form of steady carrier signals at various points through the short wave bands, unless complete shielding of the B.F.O. is used. This circuit looks like a dynatron oscillator, yet it is not. It depends upon feedback in phase to the suppressor grid through the condenser C4 of the B.F.O. circuit diagram. The screen grid is more positive than the plate. The plate voltage should be about $+22\frac{1}{2}$ volts, the screen from $+75$ to $+100$, the usual control grid at zero potential and the suppressor grid at about 6 to 10 volts negative with respect to cathode. This is accomplished by means of the resistors shown in the circuit diagram.

The B.F.O. coil L1 and condenser C1 should tune to the IF frequency and should preferably be shielded. An IF coil can be used. A jumble wound coil with a fixed .001 mfd. and semi-variable 70 mmfd. condenser is preferable because this gives a high C to L ratio with less harmonics and greater oscillator stability. Front panel control of the B.F.O. frequency can be obtained by means of C2 which acts as a vernier adjustment for C1. Bending up a corner on a stator plate makes a convenient switch to cut out the B.F.O. for phone reception. The rotor plates of C1 are grounded, thus it can readily be mounted on a metal front panel. Output from the B.F.O. should be taken from the suppressor grid in the form of a short length of hook-up wire with its free end twisted once or twice around the second detector grid lead.

These two new circuits were used in a version of the modified 222 receiver shown in the photographs. This receiver is quite similar to the modified 222 superheterodyne described in March "RADIO", except for the two new circuits. The receiver consists of a stage of semi-tuned RF using plug-in resonant chokes, a regenerative first detector, a single stage of IF, second detector, audio and a B.F.O. The high-frequency oscillator, detector and RF are exactly the same as in the original version, with only minor deviations. It was found that tuning condensers using bakelite instead of isolantite insulation, required about $\frac{1}{4}$ more of a turn in the first detector cathode tap of most coils. It was also found desirable to use a separate set of coils for 20 meters in order to obtain more band spread. Five turns, one-inch long on the $1\frac{1}{2}$ diameter plug-in coils, proved satisfactory for this band. All of the other coil data was given in the coil table in the March issue.

The crystal filter is made by removing the center universal wound coil of a Hammarlund 2.1 mh. RF choke. This gives a center-tapped plate coil which is tuned by means of a 7-70 mmfd. trimmer condenser. The neutralizing or phasing condenser is a 25 mmfd. variable because the particular crystal holder used had a very large plate-to-plate capacity. Other forms of holders might make a 2 or 3 plate midget condenser preferable. The neutralizing condenser is mounted on the front panel by means of insulating bushings and the crystal is cut in or out by means of plugging the crystal in or out. The phasing condenser has a stator plate bent up so as to short-circuit this condenser at about minimum capacity setting for phone reception. This same idea is used to turn the B.F.O. on or off for CW or phone reception.

The B.F.O. coil is made by removing turns from an old IF coil until it resonates at the desired frequency with its shunt condenser, plus the front panel trimmer condenser capacity.

In lining-up a superheterodyne with a crystal filter it is essential to know the exact fre-

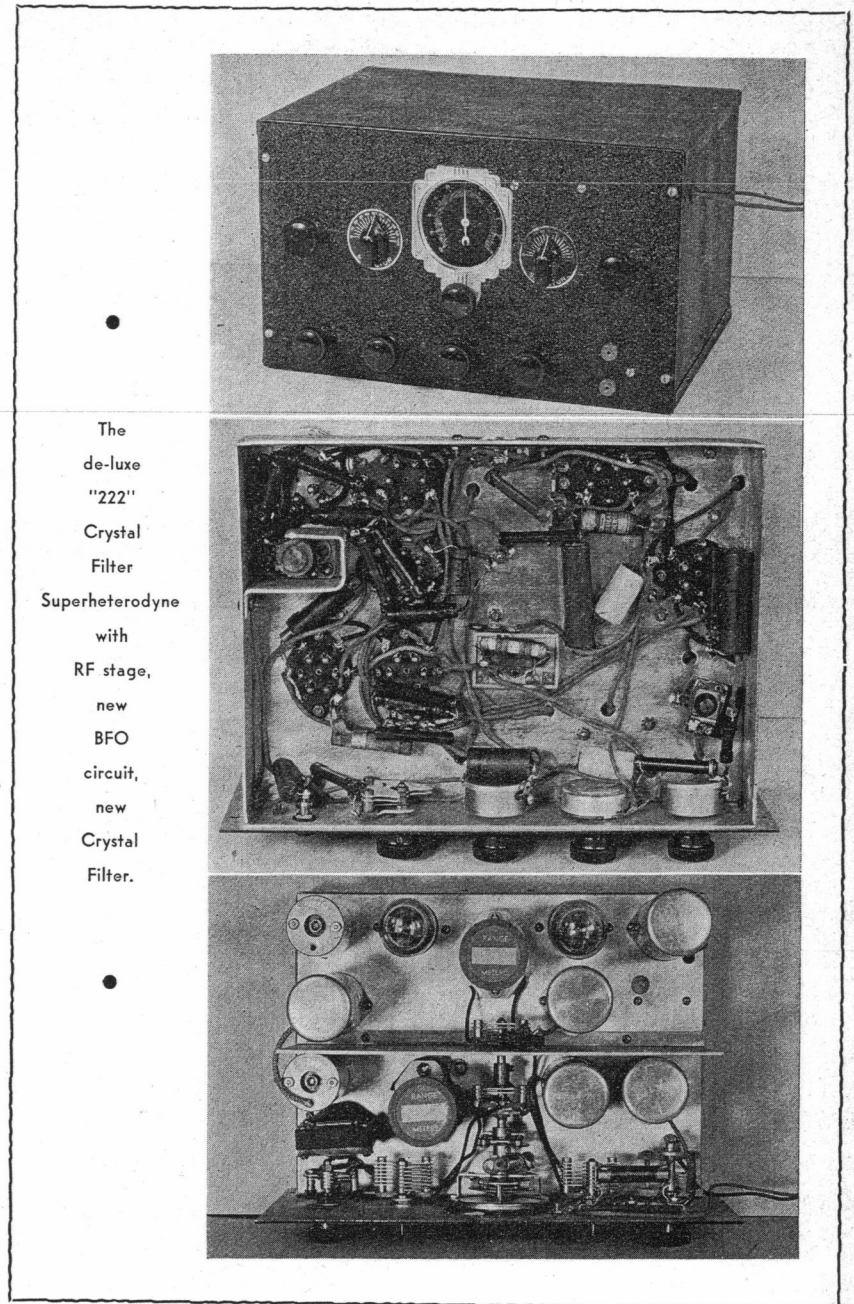

The
de-luxe
"222"
Crystal
Filter
Superheterodyne
with
RF stage,
new
BFO
circuit,
new
Crystal
Filter.

quency of the crystal. The frequency can be most easily found by connecting up the crystal in an oscillator circuit, such as a type 30 tube with 135 volts or more of plate supply. The plate circuit of this oscillator must be tuned to the crystal frequency. When oscillation is obtained, as indicated by a drop in oscillator plate current, the IF amplifier can be aligned to that frequency. Once this is accomplished the crystal can be put back into the receiver. Best single sideband reception on CW reception can be obtained by proper adjustment of the phasing condenser and BFO frequency.

Lack of good single-signal effect can be usually traced to extraneous capacity coupling, lack of proper setting of neutralizing or BFO condensers, or insufficient circuit isolation. In the receiver shown it was found necessary to shield the grid lead to the IF amplifier in order to prevent direct capacitive coupling past the crystal filter. This de-

creases the undesired signal of R9 to R5 ratio up to R9 to R3 ratio. Even better ratio could probably be obtained by better cathode, screen and plate return lead isolation resistors and condensers.

The receiver illustrated is an extremely simple but very efficient single sideband receiver. Plug-in coils simplify constructional problems and first detector regeneration gives it remarkable sensitivity and freedom from image interference.

Next Month

Ralph O. Gordon, the engineer who discovered Class B audio, will give you firsthand information on new applications for this popular system. Frank Jones has a very new 5-meter constructional article and a new grid-modulated economy 160-75-20-meter phone. May "RADIO" will be our banner issue.

The Economy Transceiver

By FRANK C. JONES

● This transceiver is easy to build and uses a very simple circuit. It is a combination receiver and phone transmitter for operation in the five-meter band. It uses one type 19 and one type 33 tube. Power is secured from 135 volts of B battery, 13½ volts of C battery and three dry cell batteries for filament supply. The filaments of the two tubes are connected in series. The total "AA" battery drain is about ¼ ampere.

A type 19 tube makes an excellent 5-meter super-regenerative detector when connected as shown in the circuit diagram. The sensitivity is better than that of many other tubes and the output is sufficient for headset operation. One section of the 19 tube acts as a super-regenerative oscillator and the other section acts as the detector. When receiving, the oscillator section has a ½ mfd. condenser shunted from plate to ground, thus preventing this triode section from acting as a grid-leak detector audio amplifier section. The other section, previously called "detector", is in reality the audio amplifier section.

This circuit eliminates the need of a 4-pole-double-throw switch for changing from transmit to receive, and vice versa. The change-over switch is only a single-pole-double-throw type, with the moving arm grounded. This switch can be of the type shown or a small snap type toggle switch can be used. When receiving, this switch short circuits practically all of the modulator output and provides a low impedance path for the detector plate circuit. When transmitting, the grid leak is lowered in value so as to obtain steady, strong carrier output and the modulator (the type 33 tube) is allowed to function.

The 33 tube is used only as a modulator and requires no reflexing with additional contacts on the send-receive switch. The mike transformer is one of the conventional small single-button mike to grid transformers. The output choke is center-tapped, although this is not absolutely necessary. A medium size push-pull output transformer to loudspeaker is satisfactory for this use; the small secondary winding is left open. This transformer should be large enough to carry 40 or 50 milliamperes without saturation. The rating can be roughly checked by using a single turn of wire connected to a 6-volt dial pilot lamp coupled to the oscillator coil. It should light up more brilliantly when the mike is spoken into. Lack of sufficient varia-

tion of intensity when modulating can often be traced to saturation of the modulation choke. A piece of writing paper, slipped into

connected as shown, in order to obtain a 2-volt negative bias for the type 19 tube. This 4½ volt battery provides ample voltage for most single-button microphones. In the usual 3 volt transceivers, many microphones are not sensitive enough to fully modulate the trans-

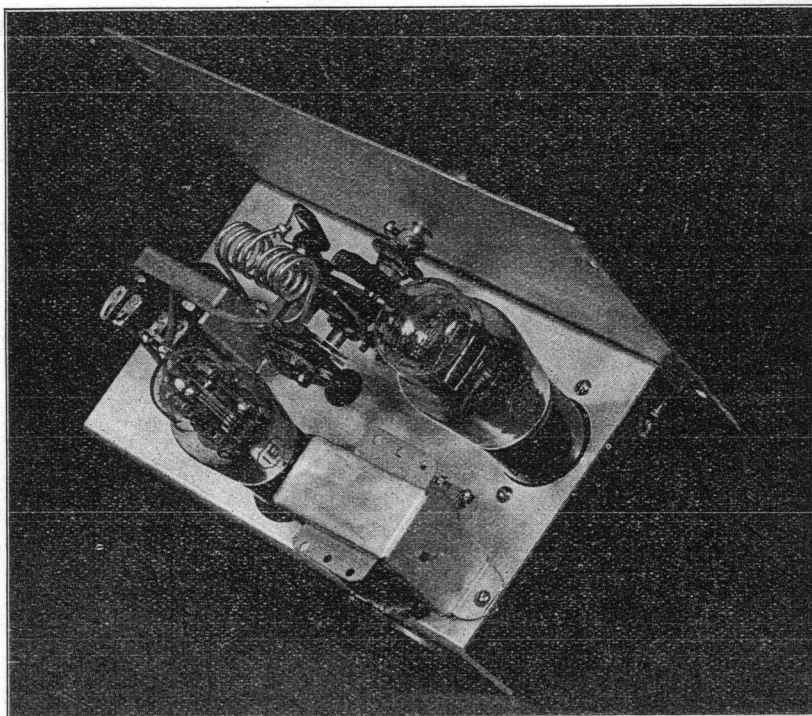

Looking into the Economy Transceiver. The correct arrangement of parts is clearly shown.

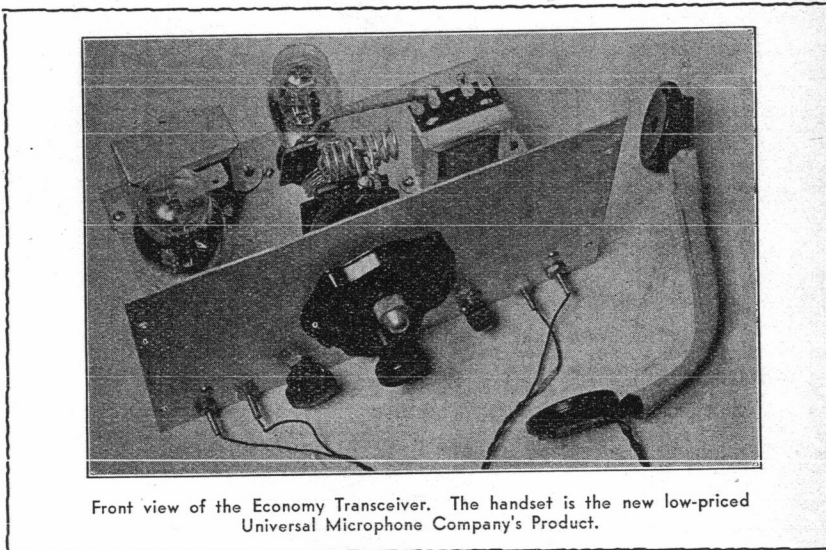

Front view of the Economy Transceiver. The handset is the new low-priced Universal Microphone Company's Product.

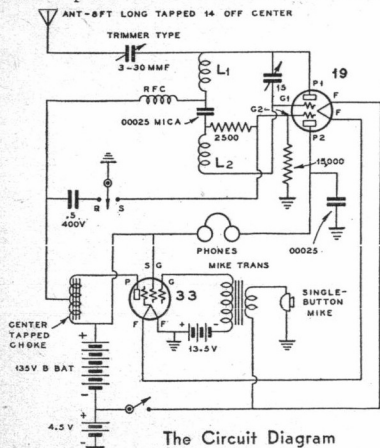

- L1, L2—Each 4 turns No. 14 wire, ½ inch dia., air supported, spaced diameter of wire.
- L3—R.F. choke of 50 turns of No. 22 DSC wire, on ¼ inch dia., air supported.

the air gap along the butt joint of this choke, will usually cure this trouble. Many builders of the original Jones 42-42 transceiver complained of low percentage modulation, whereas a good center-tapped choke would have been the solution of this difficulty.

The filaments of the 19 and 33 tubes are in series; therefore the correct polarity of the filament battery is important. It should be

mitter.

The RF choke consists of about 50 turns of No. 22 DSC wire, wound on a ¼ inch dowel rod, and then slipped off the rod. This coil is supported from the oscillator coil to a small hole in the bakelite subpanel which holds the tuning condenser. The 2500 ohm grid leak is mounted in a similar manner on the other edge of the bakelite

panel. The two oscillator coils of about 4 to 4½ turns, ½ inch diameter, are mounted on the tuning condenser and the mica condenser is soldered across the inside ends of the two coils. The turns are spaced one diameter of the wire. A two or three plate midget condenser has sufficient capacity for tuning over the 5-meter band. The grid and plate leads to the oscillator section of the 19 tube should be as short as possible. The other leads are not important and can be run under the chassis from point to point.

The antenna coupling condenser should be a 3-30 mfd. adjustable trimmer condenser. Normally this condenser will be set so that the two plates are about ⅜ to ⅝ inch apart. This is much more coupling than can be used with a 30 tube oscillator. Measurement with a thermocouple and 500 ohm dummy antenna load indicated from 2½ to 5 times as much carrier output. The plate current is about twice as much for the 19 tube oscillator. The result is approximately ½ watt of output into a two-wire 500 ohm antenna feeder with 135 volt B supply, which is a very respectable output on 5 meters. The receiver is quite sensitive for headset operation. If loudspeaker reception is desired, an additional stage of audio amplification would be necessary. It should be remembered that all transceivers radiate bad interference in the receive position and therefore they are always a nuisance to other amateurs in a congested area.

The set can be built on an aluminum chassis about 5-in. x 8-in. as illustrated, or a wooden baseboard can be used. The front panel should be of metal, about 6½ x 8-in., in order to prevent hand-capacity when operating of the set. It is convenient to use an extra tube socket for a plug and cable battery connection system. Because the front panel is of metal it is necessary to use an insulated coupling between the dial and the tuning condenser shaft. Either bakelite wafer or isolantite sockets are suitable for use in this circuit. Tip jacks or a plug and phone jack can be used for the headphones and microphone connections through the front panel. It is necessary to insulate both sides of the headphone connections from the front panel.

In testing the set, the transmitter should light up a flashlight lamp, as previously mentioned, and modulate the lamp upwards in brilliancy. In the receive position, a fairly strong hiss should be audible in the headphones when no 5-meter signals are being received. Too much capacity in the coupling condenser will prevent this super-regeneration.

Nearly any kind of an antenna can be used. A four-foot rod will work fairly well over very short distances. An eight foot rod or wire, connected to the coupling condenser,

will function very well if the condenser can be set with the two plates far enough apart to obtain super-regeneration. Normally, the best antenna is a vertical 8 foot rod or wire, as high in the air as possible. From this rod a one or two wire feeder should run to the set. The two-wire feeder gives best results. When the latter is used, one wire

should connect to the antenna coupling condenser. With either a one or two wire feeder, the connection to the 8 foot antenna is made 14 inches either or both sides of antenna center. The feeder should run at right angles from the antenna rod proper for at least 3 or 4 feet before the feeders drop down to the set.

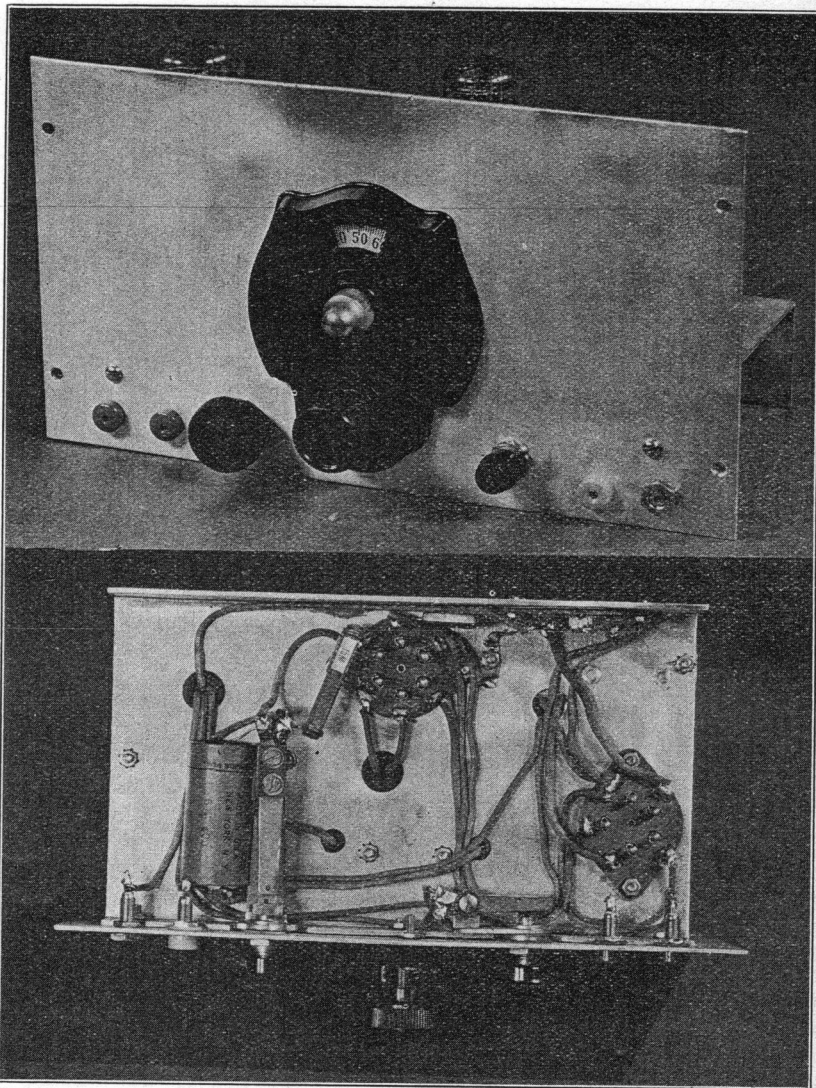

Two additional views of the Economy Transceiver. The under-chassis view plainly shows the wing.

Audio Amplifier Designations

● These three audio amplifier designations still seem to cause trouble and are used rather "loosely." Here are some general characteristics which may help to straighten-out each type of audio amplifier terminology.

All single-ended audio amplifiers operate class A (assuming that undistorted amplification is desired). There is no such thing as a single-ended class AB or class B amplifier, with the possible exception of the special circuits which require the use of the 2B6 or the 6B5 distortion neutralizing tubes. In a class A amplifier the AVERAGE value of the plate current is constant and is independent of the amplitude of the audio signal. In other words, the plate milliammeter should not vary between the no-signal and the maximum signal conditions. A strictly class A

amplifier may be used either single-ended or push-pull. The grid is never driven positive in a true class A amplifier, although with certain exceptional tubes, such as the 212D, it is sometimes permissible to drive the grid five or ten volts positive without driving the tube seriously out of the linear portion of its characteristic. However, the input transformer and driver tube must be designed to deliver a small amount of power to the grid of the amplifier. Even when the grid goes slightly positive the average plate current should not vary during operation, in any single-ended audio amplifier.

All push-pull audio amplifiers either operate class B or class AB, (formerly called class A Prime). All true class B audio amplifiers are biased to the point known as "Theo-

retical cut-off", and which is slightly less than actual cut-off. Theoretical cut-off is obtained by extending the straight portion of the dynamic characteristic curve down to the zero plate current axis. Where it crosses this line is the theoretical cut-off point and the minimum of distortion is obtained at this point. The average plate current of a class B audio amplifier varies quite widely with the audio signal and drops nearly to zero with no audio signal present. The grids of a class B audio amplifier are always driven positive, which means that a power driver must be provided. Special push-pull input and output transformers must be provided for class B operation and care must be taken to avoid DC saturation and consequent distortion.

A New 5-Meter Superheterodyne

By FRANK C. JONES

LAST month a description was given of a new type 5-meter superheterodyne circuit as simple as most super-regenerative receivers. This same circuit is here utilized in a new receiver which is more elaborate and has a number of desirable features.

It has a stage of tuned RF, autodyne detector, two stages of IF, semi-AVC and second detector and a power audio stage. The entire set is built on a chassis 8-in. by 17-in. by 1½-in. deep, and fits a standard 7-in. by 19-in. by ½-in. relay rack panel. A small enclosed 5-in. dynamic loud-speaker makes the set complete and gives very good speech quality of reproduction.

The RF stage is ganged with the autodyne detector and actually adds a little gain in the form of signal-to-noise ratio. This RF stage is similar to that used in elaborate super-regenerative receivers and it accomplishes the same purpose. It eliminates receiver radiation, although in the case of this detector circuit the radiation is only very small as compared with a super-regenerative detector. The main advantage of an RF stage is that it eliminates antenna resonance from the detector circuit. The latter should oscillate mildly over the entire tuning range; antenna resonance usually causes dead spots. A variable regeneration or oscillation control would overcome this difficulty but in some cases it is desirable to have as few controls as possible. Semi-variable RF coupling is used to the detector circuit in order to not load this circuit too much and also to prevent RF oscillation. The detector oscillates, and thus the impedance of this circuit is high and very slight common reactances will allow RF stage oscillations if the plate coupling capacity is too great. Tightening the antenna coupling will usually prevent oscillations and stabilize the circuit.

The detector uses a grid leak for obtaining smooth oscillation and detection. The IF frequency is so low that a grid-leak detector is quite efficient. A cathode RF choke is used instead of a critical cathode tap on the grid coil. This RF choke forms a common grid and plate impedance so that the tube oscillates at the frequency determined by the tuned grid circuit. The value of screen and suppressor grid voltage, as well as the size of grid condenser and leak, are chosen so as to obtain oscillation but not super-regeneration. The detector heterodynes the 5-meter signals into the IF amplifier.

The IF amplifier uses two stages of moderate gain. The values of resistors and capacities are chosen so as to amplify from about 10 or 15 KC up to 90 or 100 KC. This wide band is sufficient to allow reception of 5-meter signals emitted by modulated oscillators. The values of capacities and grid leaks are such as to prevent amplification of audio frequencies; it peaks at about 50 KC, but the response curve is quite flat and broad. Eliminating tuned circuits eliminates magnetic fields and reaction between stages. This greatly simplifies construction, since an IF transformer is simply two resistors and a small mica condenser.

The second detector is somewhat different than is normally used in most receivers. It uses a type 41 tube with the screen grid tied to the regular input grid and therefore the tube acts as a high MU triode. It really acts much like a class B tube in that the grid current starts to flow as soon as a signal is impressed. Detection probably takes place in a manner somewhat similar to that of any grid-leak detector. The rectified grid current is used to obtain semi-AVC action in order to prevent overloading on strong signals. This voltage is fed back to the grids

of the two IF amplifiers through resistive filters, so as to prevent too-great a signal being built-up across this detector circuit. The

value of detector grid resistance of 10,000 ohms is so low that there is a question as to how this detector actually works. However the audio quality is really very good. Apparently detection actually takes place in this tube because RF chokes were shunted

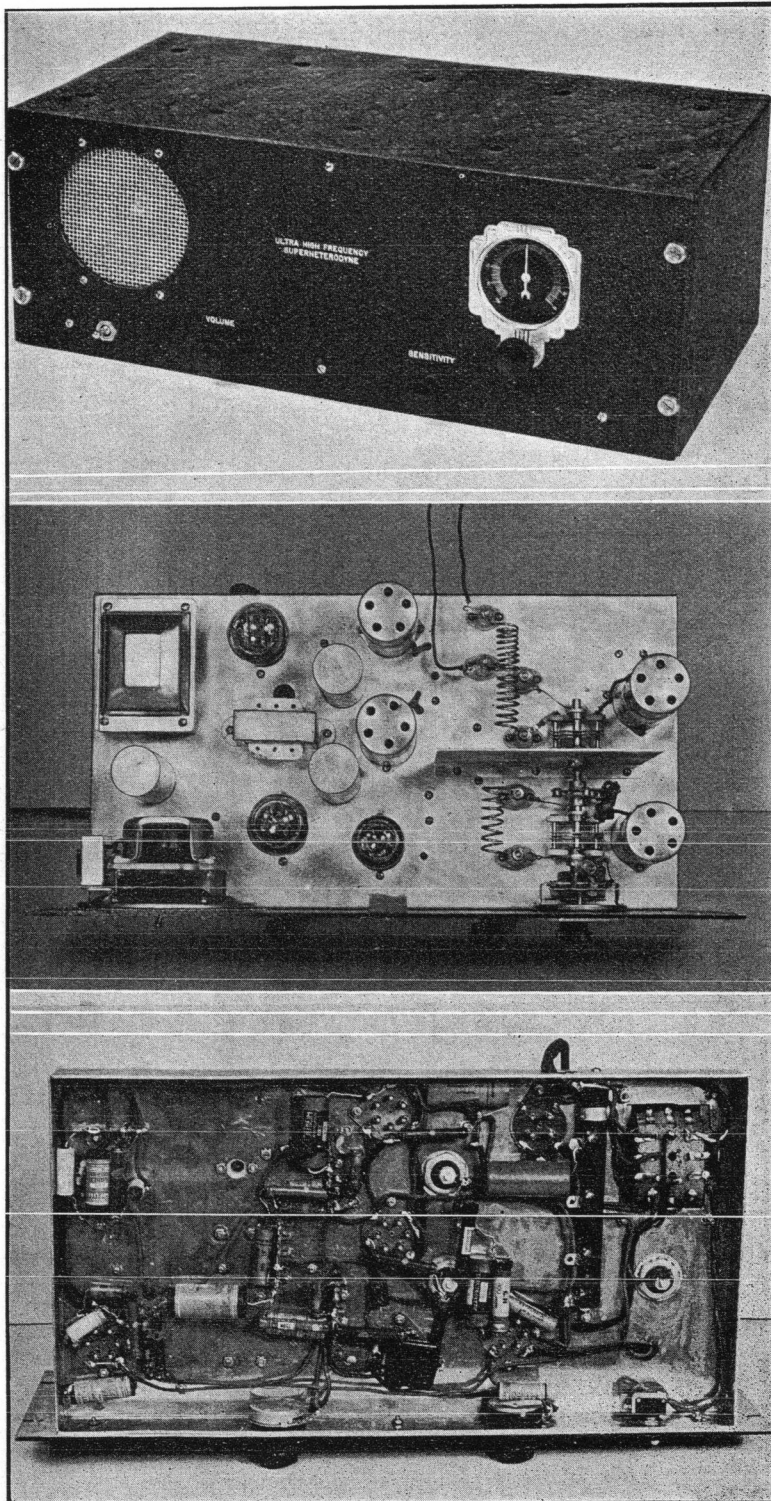

Three views of the new Jones 5-Meter Superheterodyne.

across the plate circuit of the last IF tube so as to short-out any audio components which might be there while testing the circuit.

The audio amplifier uses a 41 or 42 tube as a regular pentode in order to give loudspeaker volume in the output. An audio volume control is used and the set functions like any AVC broadcast receiver. Occasionally on extremely strong signals, the IF sensitivity control is of use although this control is normally left at full gain setting. A switch is provided for shorting the loudspeaker, when using this receiver in conjunction with a fairly-powerful 5-meter transmitter. Normally, the same antenna is used for receiving and transmitting if no attempt is made to work duplex operation.

The power supply is well filtered by means of a two-section filter using the loudspeaker field as the second section. This part of the circuit is purely orthodox.

A few interesting items were noted in constructing this and similar receivers. It was found necessary to ground the first detector heater on one side as near the socket as possible and then by-pass the other side with a small condenser, .002 to .01 mfd., to that

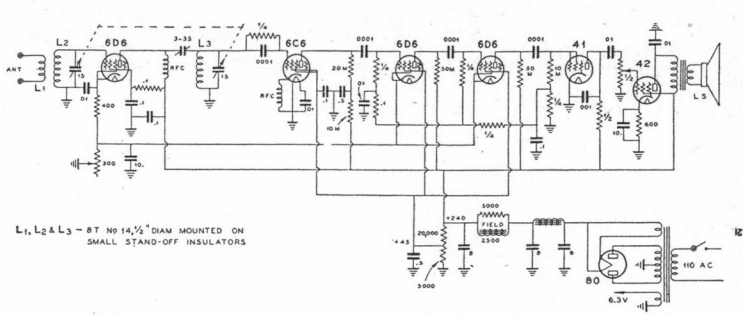

Circuit Diagram of New Jones 5-Meter Superheterodyne.

same point. In the circuit diagram the location of this heater by-pass condenser is not apparent. The same reason calls for the screen by-pass condenser lead to be short and right at the socket. Ordinary paper .01 and .1 mfd. condensers seem to act effectively as by-pass condensers even on 2½ meters in this circuit. Several makes have been tried and no difficulty has been experienced.

The RF chokes are made by winding about 100 turns of No. 34 DSC wire on a ¾-in. diameter rod. These chokes are large enough

to also work effectively on the 10 meter band.

Any form of antenna coupling can be employed. The antenna can be coupled to the grid of the RF tube through a small 3-30 mfd. trimmer condenser. Another method used was to tap one feeder up about 2 to 3 turns on the grid coil and the other feeder to chassis ground. Sometimes it is difficult to obtain enough coupling to a two-wire feeder system using an untuned antenna coil of such small dimensions as shown in the pictures.

Aural Monitoring of Radiotelephony

By HERBERT RUSS

THE amateur who is particular about the operation of his transmitter uses meters in the various circuits—and keeps an eye on them, for this is the only proper method of determining if the transmitter is working properly. For phone operation, meters do not tell the complete story. Here, in addition to the radio-frequency component, one must contend with an audio component that is secondary in importance only to the radio-frequency carrier.

Meters cannot indicate the quality of the phone signal—SOUND. The human ear still retains its prime position as a judge of sound. An aural monitor of some sort must be used.

The advantages of radiotelephony transmission monitoring are apparent. There are several methods of monitoring, but not all of them are wholly satisfactory. Some of the methods are here outlined:

Crystal detector (Galena, iron pyrites, silicon, etc.)

The receiver.

Tapped speech amplifier.

Untuned diode rectifier type.

Tuned diode rectifier type.

The crystal detector type is low in cost, simple in construction, good in fidelity but easily overloaded and has poor output gain—also it is critical in adjustment and unstable in operation.

Using the receiver as a monitor is poor policy because the comparatively strong carrier overloads the detector and results in distortion. Another disadvantage is the necessity of tuning the receiver over the band during communication.

The method of tapping the speech amplifier is very common. Its disadvantage lies in the fact that the audio is monitored directly and does not account for anything that might happen to the audio component when the audio reaches the radio frequency stage.

The diode rectifier type of monitoring is basically prevalent in broadcast stations. It is fool-proof, its consistency of operation and capability to reproduce high fidelity audio output is acknowledged. These features make

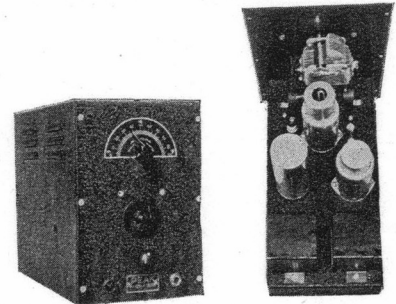

Exterior and interior views of the new Peak Linear Detection Monitor.

this type of monitor not only desirable, but necessary.

The untuned diode type is a good method of monitoring. Its reproduction is faithful. However, it possesses no inherent amplification capabilities. It requires radio-frequency

by-passing after the process of rectification has taken place. The audio output can be amplified by any of the conventional methods. However, the untuned diode is a very insensitive device and requires direct tapping of the radio-frequency output of the transmitter, or a pick-up coil must be placed in inductive relation to the output stage. It is stable in operation.

The tuned diode method herein advocated is essentially similar to the untuned type with the exception that the sensitivity is comparatively high and therefore does not require close coupling to the transmitter's output. It can be assumed that of all the methods outlined the tuned diode type is preferable. The diode method avails itself of the rectifying action which occurs between diode and filament. Although the diode does not amplify, it is particularly suited for detection when freedom from distortion is required. It is capable of audio output of less than 1 per cent distortion between 17 and 17,000 CPS flat to within minus 1 Db. This excellent frequency response is due to the essential linearity of the diode's demodulating action.

The PEAK M-2 Linear Detection Radiotelephony Monitor is of the tuned diode linear detection type. The tube used is the type 85. This tube was chosen for two reasons, (1) diode detection and triode audio-amplification can be obtained from this single tube; (2) low filament current diminishes chance induction hum.

The triode portion of the 85 tube is capable of more than sufficient volume for headfone operation. It is operated as a diode biased amplifier. The plate current of the 85 is two-and-one-half milliamperes, with no signal input and wide open gain. The greater the signal input, the lower the plate current. Audio distortion of the triode becomes evident when the plate current is one-and-one-half milliamperes or less. A meter can be used to indicate this distortion or for resonance tuning, although it is not necessary for ordinary use.

The power supply, self-contained and operated from the 110-volt AC line, is absolutely

(Continued on page 31)

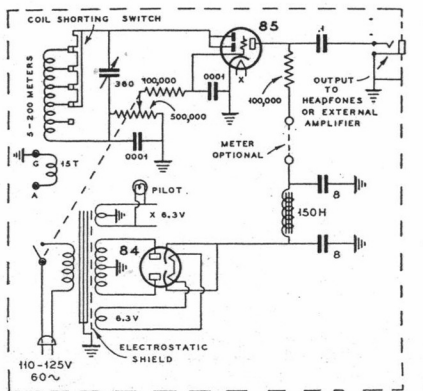

PEAK M2 AMATEUR LINEAR DETECTION MONITOR

The New G. E. Antenna System

By H. A. CROSSLAND*

● Results of many experiments and calculations in developing trans-oceanic and trans-continental antenna systems show that the doublet antenna with transmission line fills most requirements for efficient short-wave reception. The ordinary doublet antenna consists of a straight wire divided at the center by an insulator, from which point a two-conductor, transposed or twisted transmission line runs to the receiver. Properly designed, this type of doublet gives ideal efficiency at a frequency determined by its length, but not for a continuous range of frequencies covered by the short-wave bands.

A newly designed "V-doublet" antenna system is illustrated in Fig. 1. The "V-

ceiver through interference. Arrows drawn on the line represents the signal, while arrows drawn alongside represent induced interference. The interference current does not flow through the coil and the receiver is not affected. The signal current, however, flows

This permits wide latitude in choosing a noise-free location for the doublet. At least 100 feet of line should be used to maintain correct electrical matching. Excess line can be coiled at the end nearest the receiver. Transmission line is available in rolls of 100 feet, and after the initial 100 feet, the line may be spliced or cut as desired. As the line has a definite known impedance,

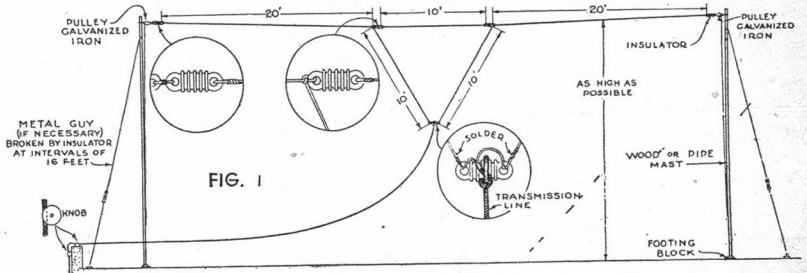

through the coil. If it is properly coupled to the receiver it will reproduce the signal in the loudspeaker.

The receiver-coupling transformer is illustrated in Fig. 1A, and the circuit in Fig. 5. The transformer is a special balanced-primary auto-transformer which matches the trans-

only the specially-manufactured transmission line should be used. Each conductor of this line is covered with a high-grade white-rubber insulation, and a covering of water-proof braid is woven over the twisted pair.

The chassis of the receiver is grounded. This new antenna system is known as the

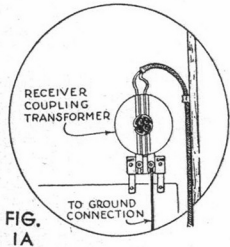

doublet" differs from the elementary doublet which tends to favor certain frequencies and reject others. The "V-doublet" is coupled to the transmission line by the converging "V". This makes the doublet respond uniformly to a wider range of short-wave signals, and the "V" matches the doublet more perfectly to the transmission line so that the signal transfer is smooth. The explanation is simple. At the top where the spacing is wide, the characteristic impedance is high and comparable to that of the doublet; at the bottom where the wires are close together, it is low to match the low impedance of the transmission line.

One of the most valuable features of the "V-doublet" system is its ability to exclude interference from outside sources when the doublet is erected out of the field of interference. Fig. 2 illustrates how the signal

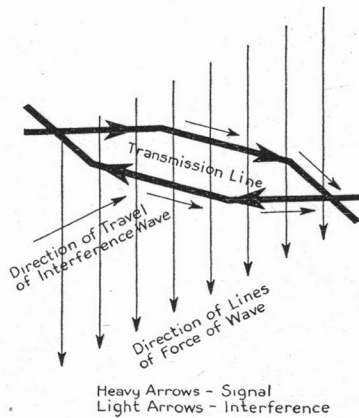

FIGURE 3

mission line to the antenna coil of the receiver and permits "in-phase" interference to flow to ground through a condenser without affecting the receiver. The size of this condenser makes it ineffective at broadcast frequencies. This permits the system to operate as a conventional "T" antenna system on broadcast signals and as a "V-doublet" on short waves. Below 55 meters the antenna is a "V-doublet"; above 55 meters it is a conventional "T-type" or standard broadcast antenna.

The design of the "V-doublet" antenna lends itself readily to various methods of suspension and is simple to install. Ordinarily the antenna will be erected on the roof of a building or suspended between the roof and a nearby tree or pole. If inconvenient to erect masts, the doublet can be suspended between two chimneys, or from the eaves of a building. Where sufficient ground space is not available to provide the normal span of 51 feet, the doublet may be shortened, with a slight sacrifice of efficiency in the region of the 49-meter band only. The directional effect of the doublet is advantageous where a source of interference is unavoidably near. Least interference is intercepted by the doublet when the horizontal wires point toward the source of interference.

If desired, the transmission line can be extended as far as 500 feet from the receiver.

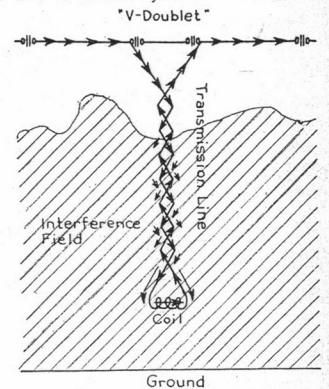

FIGURE 4

General Electric "V-doublet" Antenna, Stock No. KV-100. Additional transformers and lengths of transmission line are available as spare parts. The antenna is completely

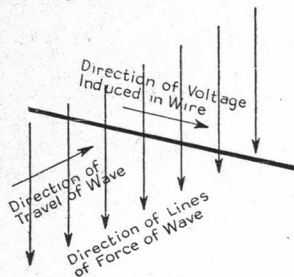

FIGURE 2

voltage is induced when the radio wave sweeps across a conductor. In the same way interference radiation induces interference voltage in any conductor within its influence. The balanced transmission line of the "V-doublet" prevents such interference from reaching the receiver, as shown in Fig. 3.

This shows how voltage is induced in the transmission line. Since the direction in each conductor is the same, these voltages are said to be "in-phase." The signal currents conducted from the doublet, having opposite directions in each wire, are said to be "out-of-phase."

Fig. 4 shows the "V-doublet" antenna with the transmission line terminated in a coil. This illustrates how a transposed lead-in can conduct a signal from the doublet to the re-

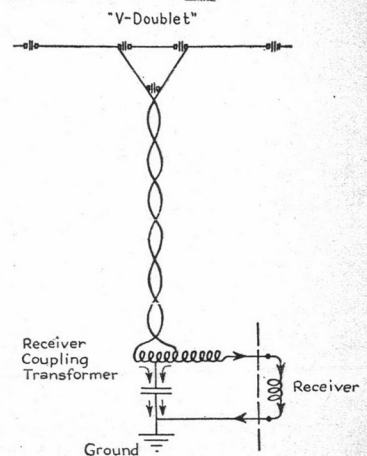

FIGURE 5

assembled at the factory. All connections to lead-in and insulators are made and the antenna is ready to suspend between masts when the kit is unpacked.

* Supervisor, Radio Field Service, General Electric Company, Bridgeport, Conn.

Why Regeneration in a Superheterodyne Is Important

By FRANK C. JONES

● Regeneration in any superheterodyne receiver is beneficial for increasing the actual sensitivity of signal to undesired noise. With plug-in coils the problem is not difficult, but in all-wave receivers using coil switching the problem is a difficult one. The use of regeneration in such receivers would be especially desirable since the losses in the coils, shields and switches is usually higher than in a set using efficient plug-in coils.

some of the tuning ranges. The coils should be shielded from each other in any good coil-switching assembly.

The detector of Fig. 1 is made regenerative in the same circuit as used in the oscillator. The grid oscillator condenser is made small enough so that regeneration can be obtained without actual oscillation. Variation of screen voltage provides a means of panel control of regeneration. The detector sup-

could be as shown, or by means of the method shown in Fig. 1. This circuit requires a 10-pole, multi-throw switch if proper elimination of dead spots is to be accomplished and good circuit tracking is desired.

Regeneration in the circuit of Fig. 2 is obtained in the RF stage by means of a cathode tap as shown. This tap will usually be only a fraction of a turn from the ground end of each coil. Control of regeneration can be

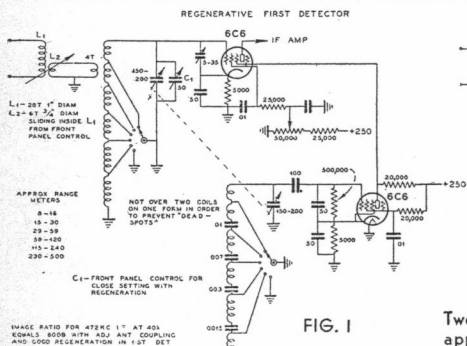

FIG. 1

Two circuits showing how to apply regeneration to a detector (Fig. 1) and to a superheterodyne with RF (Fig. 2).

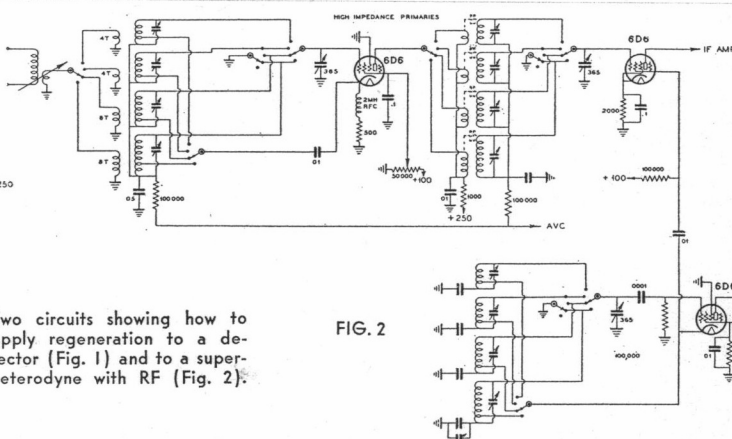

FIG. 2

The troublesome effect of image interference can be greatly reduced by means of regeneration at the signal frequency. The effect is to increase the selectivity at the signal frequency. This means more desired signal and less noise and image interference. In the two circuits shown, some ideas are given for providing a certain amount of regeneration. If enough thought is given to such ideas, some good circuits can be made available for more general use in another year or so.

Fig. 1 shows a circuit for use in an all-wave super in which no RF stage is used. The oscillator circuit is one which has been used in a commercial receiver and has proven satisfactory. It uses a Colpitts oscillator circuit with the cathode floating at RF potential. This circuit provides stable oscillation and requires no cathode tap or tickler winding on the oscillator coils, thus a very simple form of switching can be used. Because the switching is done at ground potential, there is no dead-end capacitive coupling between switch points, with attendant dead spots in

pressor grid is used to provide coupling to the oscillator and is actually run positive. A front panel trimmer condenser in shunt to the detector tuning condenser would be necessary if optimum effect of regeneration is to be obtained. In this circuit the cathode is "floating" and the IF amplifier return would have to be made through a .01 mfd. condenser directly to the cathode and plus B through a 2 mh. RF choke from the primary of the first IF transformer.

The values of resistors and condensers as shown will sometimes be modified in actual practice because of variations in receiver assembly.

The circuit shown in Fig. 2 provides a stage of tuned RF ahead of the first detector. This complicates the switching circuit, but by proper coil inductance and adjustment of individual coil trimmer condensers no front panel trimmer condensers should be necessary. The oscillator circuit is the familiar electron-coupled circuit using a cathode tap on each secondary or grid coil to obtain oscillation. Coupling to the first detector

by means of screen-grid voltage variation. By applying delayed AVC voltage to the RF stage, the regeneration is automatically cut out when receiving local or strong signals.

In both circuits shown, some method of variable antenna coupling is desirable in order to prevent antenna resonant points from too seriously affecting the regeneration. The variable "link coupling" system reduces capacitive coupling and prevents antenna resonant points. Reduction of capacitive coupling is important when using a two-wire twisted or transposed lead-in, since the noise pick-up is reduced. A properly designed "link coupling" circuit is nearly as effective as a Faraday ground shield between antenna coils for reducing noise and giving a balanced circuit.

Regeneration is often desirable on any short wave band, but below 30 meters it is practically a necessity if a person really wants to hear those dx signals. On 10 and 20 meters, regeneration should always be used in conjunction with a noise-reducing type of receiving antenna in order to minimize auto ignition and power noise.

Mid-America Dakota Division Convention

THE Minneapolis and St. Paul Radio Clubs have arranged a fine program for their Annual Convention which will be held May 3, 4 and 5 at the West Hotel, Minneapolis, Minnesota. Speakers of note from many parts of the United States will give the amateurs of the Northwest the latest technical information in the field of their own hobby. Prizes from leading radio manufacturers and jobbers will be taken home by the lucky winners in various contests.

George Grammer, assistant technical editor of QST, and John Reinartz, world-famed amateur engineer and for the RCA, will head the list of technical speakers. The Raytheon Manufacturing Company is sending a tube engineers to tell the amateurs about the newest developments in pentode power tubes. Frank Hajek, W9ECA, engineer of the Taylor Tube Co., Chicago, will speak on new

things which the amateur will be doing with his new tubes. Al Kahn of the Electrovoice Microphone Co. of South Bend, Ind., is scheduled to appear with something new on modulation and speech. Art Bates of the Citizens Call Book Company of Chicago will have his usual interesting comments. Dr. B. Simpson, W8CPC, of Buffalo, N. Y., has promised his appearance to help organize a Dakota Division Radiofane Association to better represent the fone men in the activities of the ARRL.

The registration fee will be less than three dollars and arrangements are being made to accommodate many out-of-town hams in the homes of twin city amateurs. There will be something doing every minute of the three days, including special army and navy meetings as well as an open forum meeting and stag party. A very interesting banquet program has been arranged. Special arrangements are being made for YLs and XYLs who are not interested in the technical meetings.

Prizes for the occasion are already being received by Rex Munger, W9LIP, general chairman of the convention. A complete transmitter of medium power is being assembled; it will be the grand prize which will be given away at the conclusion of the prize drawing on Sunday morning. The open forum meeting on Friday night will prove interesting to everyone and the organization of a fone operator's association on Saturday will lure the old "mike" men into the fold when the plans are announced by Dr. Simpson, W8CPC, founder of fone associations in the Atlantic, New England, Hudson and West Gulf Divisions. Last but not least, good fellowship and the real spirit of hospitality of the Twin Cities gang will guarantee a bang-up good time.

Reservations should be sent to: R. L. Munger, General Chairman, 2484 University Avenue, St. Paul, Minn.; or P. R. Gould, W9DHP, Pub. Chairman, 2515 Irving Ave. So., Minneapolis, Minn.

The New RCA-954 Acorn Pentode

● The new RCA-954 acorn type pentode tube has just made its appearance and experimenters can now have a real screen grid tube for ultra-short wave receivers. This new tube is the same size as the 955 triode

From the tentative characteristics of this new tube it can be seen that the input and output capacities are only a small fraction of the 6C6 or 57 tube. It therefore becomes very useful as an RF amplifier for wave-

leads should be made to a common point in order to avoid RF interaction.

As an audio amplifier the tube may be used with 250 volt plate supply; screen voltage, 50 volts; control grid voltage, 2.1 volts;

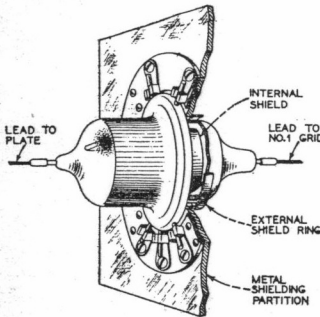

1. Terminal Mounting Template

acorn tube and fits the same socket. The plate and control grid connections are brought out through the two tips and thus these elements can be easily shielded from each other. The heater and cathode leads are

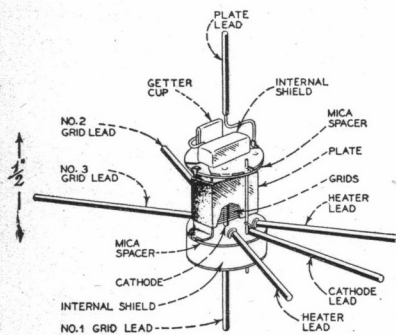

3. Internal Structure

brought out along the edges in a manner similar to that of the 955 tube. In the 954 tube the screen and suppressor grids are brought out at the same points as the plate and grid leads of the 955.

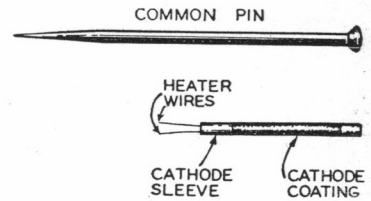
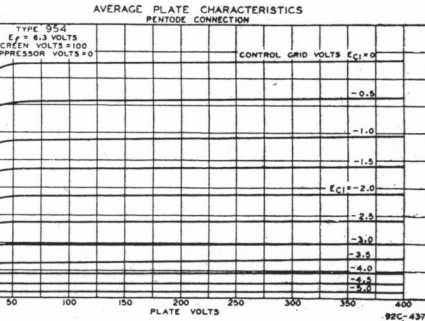
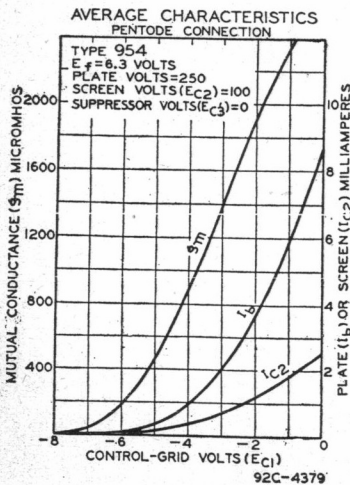

4. Comparison of Cathode with Common Pin

suppressor connected to cathode; plate load resistor, 250,000 ohms; and plate current of 0.5 MA. With a 1 megohm grid leak, a voltage amplification of approximately 100 can be obtained.

For detection, the grid bias can be obtained by means of a resistor of between 20,000 and 50,000 ohms.

The 954 tube should be ideal for amateur 2½ and 5 meter receivers using super-regenerative detector circuits. As a RF amplifier, it would not only prevent receiver radiation but would also give a decided increase

lengths below 10 meters. In properly designed circuits it is said to give a gain of 3 at one meter, and 10 or more at 5 meters. Except for its extremely small size it is quite similar to a 57 or 6C6 tube in its other characteristics and may be used as a detector, RF amplifier, AF amplifier or as a triode tube. The latter use is made in a special vacuum tube voltmeter since the tube is so small and the input capacity so low that it can be used for RF measurements. In this case the tube is mounted on flexible leads so that the tube connects directly across the circuit under measurement.

In shielding this tube for RF measurement, the control grid end of the tube is inserted through a hole in a metal plate so that the metal edge of the hole is in close proximity to the internal shield. It may be desirable to provide a small metal collar on the baffle hole in order to increase the shielding effect.

RF grounding should be by means of small condensers, right at the tube terminals. For very high frequencies flat ribbon leads to the clips should be used. These leads should be insulated from the metal shield plate by means of mica spacers. These connections then act as by-pass condensers. In RF amplifiers, the tuned grid and plate return by-pass

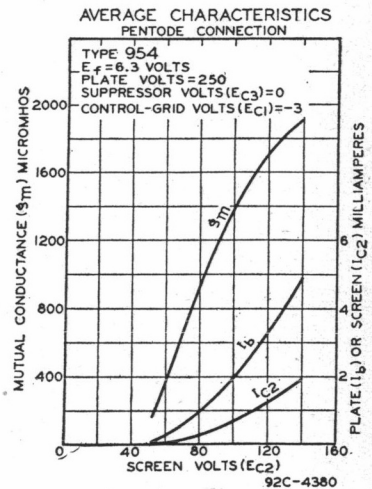

TERMINAL MOUNTING TEMPLATE
TOP VIEW

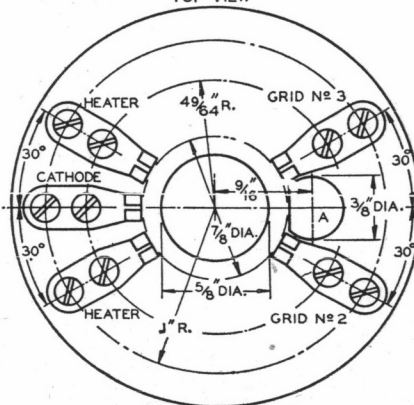

A = ALIGNMENT PLUG 1/8" HIGH
 NOTE: INSERT TUBE IN CLIPS SO THAT SHORT END OF TUBE RESTS IN THE MOUNTING HOLE

of receiver sensitivity. It should also work out satisfactorily as an autodyne first detector in the ultra-short wave superheterodyne receivers which use "resistance coupled" IF amplifiers.

RCA-954 TENTATIVE CHARACTERISTICS PENTODE CONNECTION

Heater Voltage (AC or DC)	6.3	Volts
Heater Current	0.15	Ampere
Direct Interelectrode Capacitances:		
Control-Grid to Plate (with shield baffle)	0.007 max.	uuf
Input	3	uuf
Output	3	uuf
Overall Length	1 1/8"	± 1/16"
Overall Diameter	1 3/8"	± 1/16"
Bulb		Special
Terminal Mounting		J-4
AMPLIFIER—CLASS A		
DC Plate Voltage	250 max.	V.
DC Suppressor (Grid No. 3) Voltage	100 max.	V.
DC Screen (Grid No. 2) Voltage	100 max.	V.
Typical Operation and Characteristics:		
Heater Voltage	6.3	6.3
DC Plate Voltage	90	250
		V.

(Continued on page 25)



A Linear Rectifier

• The linear rectifier has an important place in any amateur phone station.

The unit consists of two type 30 tubes used as diode rectifiers in push-pull so as to obtain as linear rectification as possible. It operates from a 4½ volt C battery and a 45 volt B battery, the latter used only as a source of bucking DC voltage when the unit is used with a peak (or crest) voltmeter, such as described last month. Because the filaments of the tubes are in series, the current drain is only 60 milliamperes and since the unit is only used while making measurements, a 4½ volt C battery functions satisfactorily.

The pick-up coil consists of about 20 turns on a 2-inch form, center tapped, and connected to the main unit with twisted flexible leads 3 or 4 feet long. This pick-up coil is coupled to the transmitter final tank circuit. The circuit is fairly simple and requires a few small resistors and mica condensers, a 25,000 or 50,000 ohm potentiometer and a reversing DPDT switch. The battery on-and-off switch should be a DPST switch in order to open both battery circuits when the instrument is not in use. The reversing switch allows one to read the "up" and

peak voltmeter. The latter will then read the upper and lower sides of the modulated envelope of the carrier by use of the reversing switch.

This is accomplished by means of the peak or crest voltmeter, since a modulated wave will give a steady voltage across the 2500 ohm resistor and the upper and lower sides of the wave will give a voltage added to, or subtracted from the DC voltage over one audio cycle. The DC voltage is bucked-out evenly by the B battery voltage. The peak voltmeter is unidirectional and thus a reversing switch actually allows one to measure both up and down modulation.

Measurement of both up and down modulation will show whether either side is flattened off because of some misadjustment of the transmitter. If a sine wave audio oscillator is used across the input to the speech system of the phone transmitter, and if everything is ok, both up and down values will be the same for any degree of modulation up to 100%. A variable frequency audio oscillator allows a frequency run to be made on the overall transmitter system.

A curve of percentage modulation should

enough linear audio output was obtained. Wrong bias on an audio or modulator stage will also give this second harmonic effect; the up and down meter readings will be different.

This system can be, and has been used on

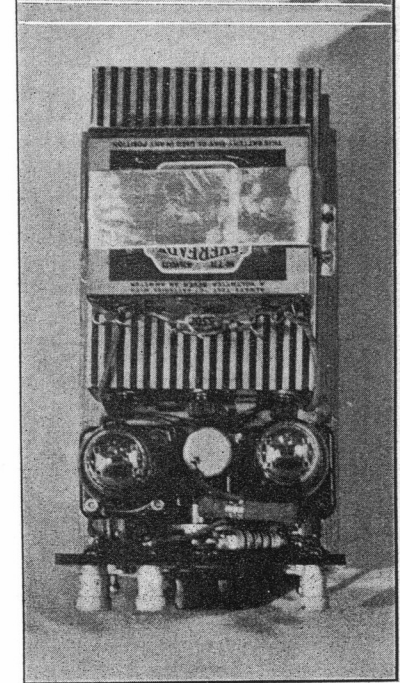
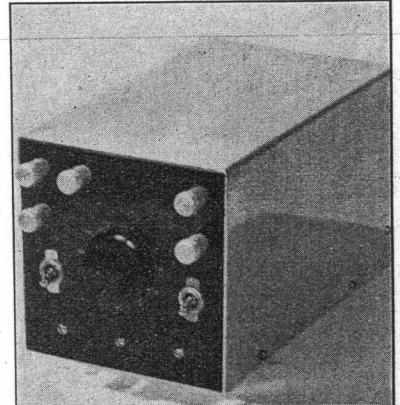

Exterior and interior views of the Linear Rectifier

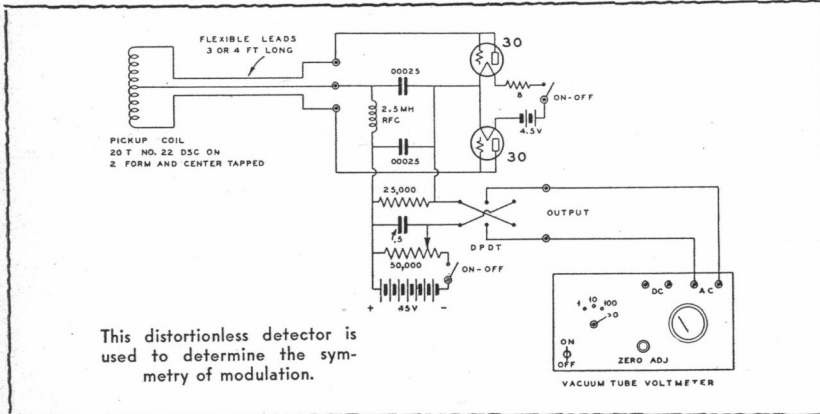

"down" modulation on a carrier wave. The unit is built into a box 5"x5"x9". Input and output binding posts are provided on the front panel.

The pick-up coil is coupled close enough to the transmitter tank coil to give a rectified DC voltage of about 30 volts across the 2500 ohm resistor. This can be checked easily by means of the DC voltmeter connection on the peak vacuum tube voltmeter described last month. This reading should be taken with the 50,000 ohm potentiometer turned to zero, because then there is no voltage from the 45 volt B battery. This same connection will show carrier shift when modulating—this reading should stay constant for any degree of modulation up to 100%. If it changes, there is carrier shift.

When the coupling coil has been properly adjusted to give a carrier DC output of about 30 volts, the potentiometer should be adjusted to balance-out this voltage, i.e., 30 volts of B battery is used to balance-out this DC voltage from the rectified current of the carrier. When this adjustment has been made, the output should be changed from the DC to the AC binding post connections on the

be a straight line from zero audio input up to the value which gives 100% modulation, or 22% increase of antenna current. If the peak voltmeter is accurately calibrated, the value of 100% can be determined by the ratio of DC reading to AC up and down readings. Departure from a straight line indicates one of the following troubles:

- (1) Lack of grid excitation on the modulated Class C stage.
- (2) Class B RF stage, if used, not adjusted properly.
- (3) Lack of neutralization of feedback due to absence of proper shielding.
- (4) Circuits not in tune.
- (5) Too low a value of capacity in the final tank circuit, which does not give enough "flywheel" effect to the final LC circuit.
- (6) Non-linear audio or modulator system.

A typical case of the latter was found in a 50 watt phone station which modulated upwards, but the up and down measurements were not the same at values above 80% modulation. The class A (845 tubes in push-pull) output or modulation transformer had one or more shorted turns and thus not

a 5-meter phone transmitter to show how poorly it usually operates. It accomplishes most of the purposes of a cathode ray oscillograph at a fraction of the cost. A great deal can be learned by experimenting with adjustments of a 160, 80 or 20 meter phone station with these two units and an audio oscillator.

A very simple audio oscillator can be made from an oscillating receiver tuned to give an
(Continued on page 35)

Combination Low-Voltage and High-Voltage Phone Using 3 Low-Cost Tubes in the R. F. Portion

By "LINEAR"

● Here is a relatively simple phone for use on 160 or 75 meters. If a doubler stage is added between the 50T and the 45, the transmitter is ideally suited for 20-meter operation because the 50T is an extremely-low-C tube.

The power output of this transmitter is quite flexible and depends entirely on the plate voltage applied to the final amplifier.

With 1000 volts of plate voltage available, the 100 MA plate current limitation on the 50T allows 100 watts of DC plate input to

that the plate current drawn by the modulators will not vary during modulation, thus making it easier to detect any maladjustment of the transmitter.

If 1500 volts of plate voltage is available for both the modulators and the final amplifier, the power input and output can be increased proportionately. The DC input to

the output will be about 70 to 75 per cent of the DC plate input to the final amplifier (150 watts) so that the carrier power output will be in the neighborhood of 105 to 120 watts.

If the DC plate voltage applied to the final amplifier can be raised to 2000 volts, it is possible to obtain 200 watts of DC plate input to the final (at 100 MA), if the RF portion of the transmitter is operating efficiently enough to allow the final amplifier to operate higher than 75 per cent plate efficiency. In other words, 75 per cent of the DC input must be drawn out of the plate tank circuit of the final amplifier in order that the 25 per cent remaining there as plate loss will not exceed the plate dissipation rating of the 50T, which is 50 watts. Thus if the final is operated at better than 75 per cent plate efficiency, the carrier output goes up to the 150 watts. The 2000 volts applied to the final amplifier is too high for safety insofar as the 845s are concerned, and they MUST, in this case, be fed with plate voltage from a separate 1500 volt power supply.

Because the DC plate input is now 200 watts, the 845s will be called upon to supply 100 watts of audio power, which they can carry when operating in class AB, wherein the grids are driven somewhat positive.

When the modulator grids go positive they will draw power from the driver stage, which can be easily supplied by the triode 42 stage. If class AB operation of the 845s is chosen, it will be necessary to use a husky transformer of about one-to-one, or possibly a slight step-down ratio, between the 42 triode and the push-pull 845s. This will minimize the distortion that accompanies positive excursions on the part of the 845 grids. The newer type of carbon plate 845s seem to be quite free from the unwanted secondary

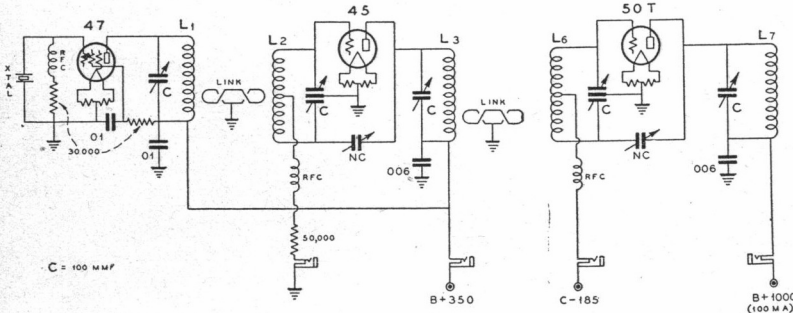

The highly flexible C.W. or phone transmitter circuit. Grid neutralization and link coupling are used.

the final amplifier. The plate efficiency will usually be somewhere between 66 and 75 per cent and consequently the carrier power output will be between 66 and 75 watts.

100 watts of DC plate input requires 50 watts of undistorted power output from the modulators, in order to secure 100 per cent modulation capability. The two 845s in the audio amplifier can deliver this 50 watts of audio output at 1000 volts and the tubes can be operated strictly by class A. This means

the final will then become 150 watts (1500 volts at 100 MA), and the required audio power 75 watts (50 per cent of the DC input). This audio output of 75 watts is easily obtained from the two 845s by running them in extended class A with somewhat more than true class A bias. However, it will not be necessary to drive the grids of the 845s positive.

With 1500 volts of plate voltage available for both the modulators and the final ampli-

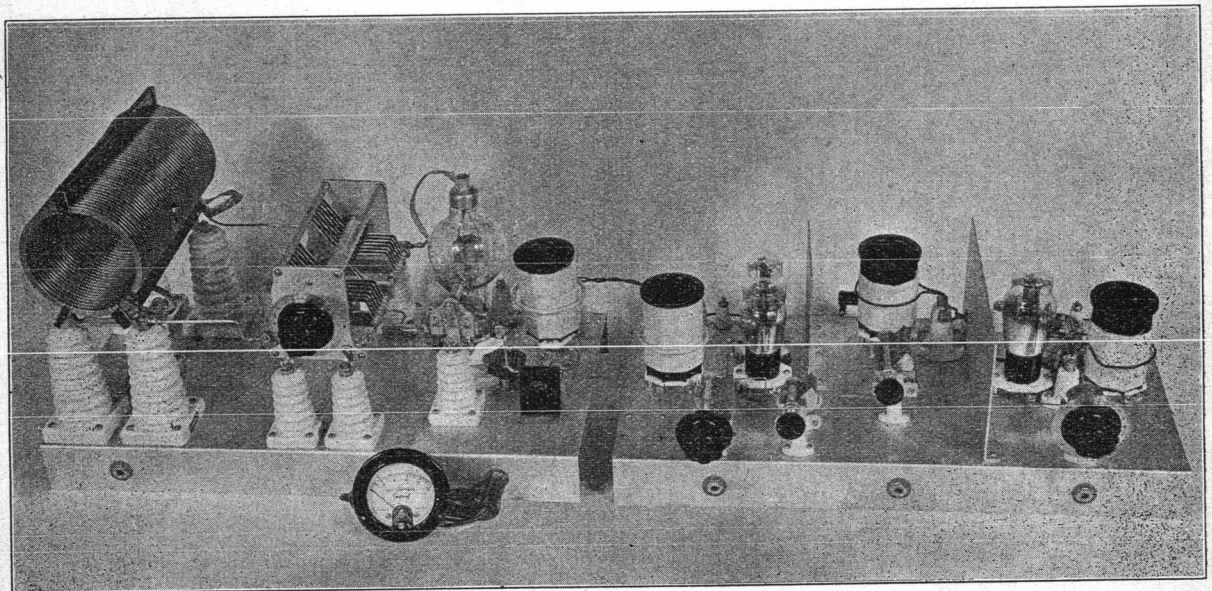

'47 Oscillator, '45 Buffer and EIMAC 50T. Here is the modern way to get high power at low cost. The new Johnson Transmitting Inductance is used in the final amplifier.

emission which made the older 845s unfit for extended class AB audio service. It is quite possible to obtain from 150 to 180 watts of exceptionally clean audio power from two 845s in class AB, operating at 1500 volts on the plate. However, it is recommended that somewhat more grid drive be provided in such cases. Push-pull 42 triodes, connected and operating class AB, do quite nicely and will deliver more than 15 watts of grid driving power to the modulators. In the case of this particular transmitter 100 watts of audio power is the maximum that will be required and thus there is no need to operate the modulators under extreme conditions.

The RF oscillator and driver for the modulated final amplifier are fairly conventional, except for the fact that so small an exciter unit serves to fully drive so potent a final amplifier. Credit for this feature lies both in the high transconductance of the 50T, which allows a high power gain through the tube, and also to the use of link-coupling throughout. Link-coupling is rapidly becoming standard practice the world over. Even though it requires the use of a few more parts than capacitive coupling, it always delivers the maximum excitation to every stage.

The oscillator stage uses the standard 47 tube. This stage is link-coupled to a buffer which uses a 45 as a neutralized amplifier. The 45 can be used as a doubler but its output is not high enough to effectively drive the final amplifier to full output. An additional stage should be used if frequency doubling is desired. Such a stage can consist of a link-coupled 210 located between the 45 and the final amplifier. It could also consist of a pair of 45s in push-push. The use of the 45s in push-push makes possible the use of one 300 to 400 volt power supply to take care of the entire exciter unit, whereas a 600 to 700 volt power supply would be necessary if a 210 doubler is used.

Grid neutralization is used in the 45 stage and a cheap split-stator condenser can be used in the grid circuit. A double-spaced midjet split-stator condenser would be required if the 45 stage were neutralized in its plate circuit. The neutralizing condenser for the 45 can be one of the midjet type of about 15 to 25 uufds maximum capacity. The 45 stage uses grid leak bias and care should be taken to tune-up on low voltage because the negative bias on the 45 depends entirely on the presence of grid excitation to that stage.

In other words, if the crystal stage is not oscillating, or if the grid tank of the 45 stage is detuned, the 45 stage will be without bias and heavy plate current will flow.

The final amplifier uses the 50T in a conventional grid neutralized link-coupled amplifier. The grid condenser can be one of the double-spaced, split-stator midjet types. The neutralizing condenser can be a pair of one inch by one inch aluminum plates. The capacity required to neutralize the 50T is approximately 2.5 uufds.

An 800 type tube can be substituted for the 50T with practically no changes, provided it is not supplied with more than 1000 volts of plate voltage on the final amplifier. Some users of 800s report satisfactory operation in a CW transmitter with 1500 volts on the plate, but it is not desirable to use more than 1000 volts for phone use. The DC plate current on an 800 should be kept below the 100 MA allowable with the 50T because the

800 has a materially smaller filament. 75 MA of plate current is a safe value at which to run the 800.

No antenna coupling is shown in the diagram because practically any type can be used. One of the best systems is to link couple the final amplifier to another coil which can then become part of either a Zepp feeder system or be coupled directly to almost any type of transmission line.

The audio channel has more than enough gain to work out of any of the diaphragm type of crystal microphones. Any type of carbon mike will also drive the audio channel to full output. In fact, many of the high level carbon mikes will be capable of over-modulating the final amplifier unless care is taken to see that the gain is held down to the proper point. A surplus of audio gain was provided in order to ply safe. It is very easy to cut down the gain by means of the

tomed to using. These condensers are very cheap and are of material help in eliminating undesirable feedback from this relatively high-gain amplifier, as well as improving the fidelity of the entire amplifier.

The 42 stage is operated as a triode, which permits it to act as a low MU, low plate resistance triode, a desirable feature in all audio driver stages.

The bias shown for the 845s is correct for 1000 volt operation. It will vary with different makes of tubes and also with plate voltage. The bias on the modulator is of the utmost importance and must be adjusted to suit the individual plate voltage actually present on the plates of the modulators. One good way to adjust the modulators is to start with high grid bias and then reduce it until the DC plate current drawn by the two modulator tubes, multiplied by the ACTUAL DC plate voltage, equals 175 watts. In other

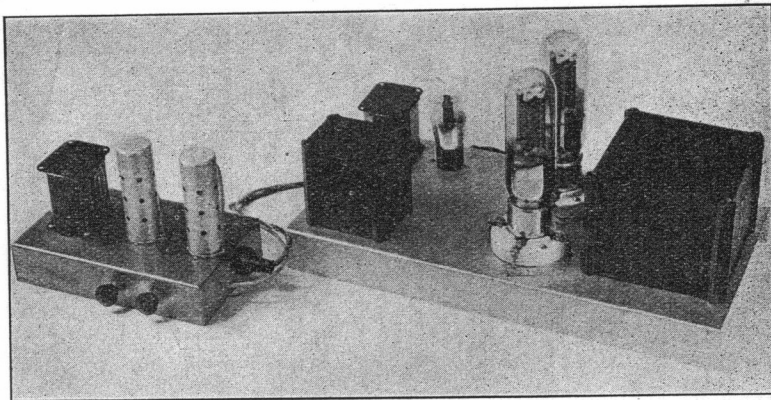

The Pre-Amplifier and the Push-Pull 845 Stage.

gain control, but it is a dismal job to complete the amplifier and then find that another audio stage must be added somewhere, due to lack of gain. The first 6C6 operates as a pentode and is resistance coupled to the grid of the second 6C6 which has its screen and suppressor grid tied to the plate and thus becomes a triode. This stage is transformer coupled to the 42 triode driver stage through a conventional interstage audio transformer. The plate voltage for the second 6C6 is shunted in order to keep the DC out of the primary of the interstage audio transformer. If a really high quality audio transformer is used at this point the necessity for using shunt feed will be eliminated. However, its use is desirable when trying to get good low fre-

words, an audio amplifier is zero per cent efficient when there is no audio signal present; all of the plate input power then serves to heat up the two tubes. Thus it follows that the plate current times the plate voltage must not exceed the rated plate dissipation of the tubes used. In the case of the 845s, the two tubes can easily dissipate 175 watts in the form of heat from their plates (80 to 90 watts per tube).

Tuning-up this transmitter is in no respect different from tuning-up any other link-coupled phone. Last, but not least, remember that no plate current anywhere in the entire transmitter should vary during modulation, with the exception of the plate current to the 845 modulators, which should increase some-

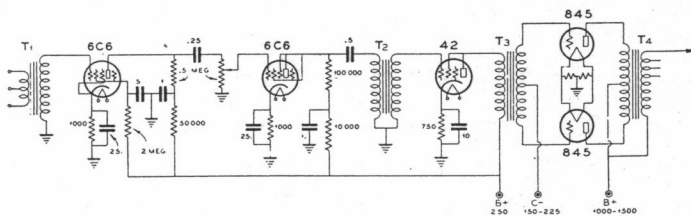

Circuit Diagram of the Complete Audio Amplifier Channel.

quency response from an old type audio transformer. The gain control is in the grid circuit of the second 6C6 in order to avoid hand capacity and various feedback troubles which occur when the gain control is placed in the grid of the first stage. The various cathode by-pass condensers shown in the audio channel are somewhat larger than one is accus-

what as modulation is applied to the microphone.

Proper grid excitation to the final amplifier is indicated when 25 to 30 MA of DC grid current flows through the bias source. Proper bias for the final equals the plate voltage divided by five. Battery bias should be used for the 845s.

The Newest Wrinkle in Modulation Chokes

By J. N. A. HAWKINS

THE use of a choke in a power, or plate modulation circuit was first shown by Mr. R. A. Heising of the Bell Laboratories about 1921. Since that time there has been little change in the fundamental Heising circuit. In the past four years the use of push-pull modulators has grown widely, due to the ability of the push-pull circuit to enable more undistorted power output to be obtained from small tubes than could be obtained from the same tubes in strict class A. The push-pull arrangements usually employ the over-biased type of amplifier operation, called either class A-B or class B, depending on whether high or low mu tubes are used.

It has always been customary to use an output transformer to couple the audio output of push-pull modulators. This requires two windings on the output transformer and is a quite satisfactory practice. However, under certain conditions the losses inherent in a transformer with two separate windings become so great as to necessitate extremely expensive construction in order to obtain satisfactory efficiency and fidelity. Under these conditions it is often possible to obtain the same fidelity at a considerably lower cost by means of a tapped output choke in place of the transformer. Choke coupling cannot give as good fidelity as transformer coupling, PROVIDED cost is no object.

However, the output transformer would be extremely expensive and its use would only be justified in a high-fidelity broadcast station where quality is paramount and cost is secondary.

Let us consider under what conditions the use of choke coupling out of a push-pull stage is advantageous. Let it be assumed that a given class B modulator stage is delivering audio power to a class C radio frequency amplifier. The resistance of the plate to ground path through the class C stage represents the load to which the modulators are delivering power. This load resistance is reflected back into the plate circuit of the modulators by the output coupling device, whether it be a choke or an output transformer. The load which is reflected back into the modulator plate circuit is usually defined as the plate-to-plate load resistance. This indicates the AC ohmic resistance looking into the output device and measured between the two plate leads.

If the class C amplifier is disconnected from the output coupling device, the plate-to-plate load resistance naturally rises. If there were no losses in the coupling device it would rise to infinity. In other words, the plate-to-plate load resistance would be infinitely high. However, this is only true of a theoretical coupling device and all available transformers have losses and leakage reactance. This means that the coupling device itself reflects back into the tubes a finite load resistance which is in parallel with the useful load resistance, when the load is coupled in. This inherent reflected resistance is ordinarily not a particularly bothersome disadvantage in most of the ordinary modulator combinations using low plate voltages, because they usually work into relatively low values of plate-to-plate load resistances and the RATIO between the useful load and the loss load resistance due to the coupling device is so high that the RESULTANT load resistance is affected but slightly. It should be evident that a high resistance shunted across a low resistance causes only a small reduction in the RESULTANT resistance of the two.

However, getting large power outputs from small modulator tubes requires that HIGH

PLATE EFFICIENCY be obtained. The audio power output from any given set of tubes can be exactly doubled without increasing the plate loss, by merely raising the plate efficiency from 50 per cent to 66 per cent.

Experience with class C RF amplifiers has demonstrated to most amateurs that the plate efficiency of ANY vacuum tube amplifier depends entirely on the RATIO OF EXTERNAL LOAD RESISTANCE TO INTERNAL TUBE RESISTANCE. Thus the higher the load resistance, the higher will be the plate efficiency, given enough grid drive to keep the tube resistance constant. Certain other things, such as grid drive and plate voltage must be raised if the plate load impedance is raised, but it will be assumed that the modulator tubes are of a type that will stand the higher plate voltage and that an excess of grid driving power is available.

When plate voltages above 1500 to 2000 volts are available, and modulator tubes such as 212Ds, 852s, 50Ts, 354s and 150Ts are on hand, it is possible to start to realize the above-mentioned gains in plate efficiency and power output. However, the losses in the output coupling device begin to become bothersome and really-good class B output

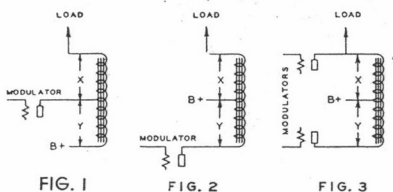

transformers begin to cost REAL MONEY . . . out of all proportion to the increase in power handling capability. When the modulators are working into a 4000 to 7000 ohm P to P load resistance, as used in many conventional class B circuits using low voltage tubes such as 46s up to 203As, the transformer problem is rather simple but when the P to P load resistance must be up around 20,000 ohms, transformer troubles begin.

Several makes of cheap class B output transformers were tested in some recent experiments on high efficiency class B audio amplifiers and it was found that the plate-to-plate load resistance reflected back into the modulator tubes was barely 20,000 ohms WITH THE TRANSFORMER SECONDARY OPEN AND THE EXTERNAL LOAD DISCONNECTED. Thus the maximum obtainable resistance unloaded, which theory assumes to be infinite, was embarrassingly finite, and seriously limited the power output. The trouble was entirely due to the lack of primary inductance in the cheap output transformers. In a choke, on the other hand, the entire core window can be utilized for primary turns, instead of taking up 50 per cent or more of the available space with secondary wire and interwinding insulation.

The first choke experiments were made with an ordinary center-tapped choke connected as shown in Fig. 3. At first there was some fear that tapping on the load to just one end of the choke might unbalance the load on the two modulator tubes, as well as causing excessive harmonic distortion. Such was not the case. Provided the choke consists of one continuous winding, and if there is close coupling between each half of the winding, the two modulator tubes will be found to heat evenly, indicating good

balance, and tests have shown the harmonic distortion to be quite low. In one test, using a UTC type HUC 500 modulation choke to couple the output of a pair of 150Ts into a resistance load, an output of 750 watts of audio power was obtained with less than 7 per cent harmonic distortion. The plate voltage was 3000 volts and the load impedance was 20,000 ohms plate-to-plate. A class B output transformer designed to give as good results would probably cost from three to five times as much as such an output choke. The circuit used with the HUC-500 is shown in Fig. 6. Note the various taps. If you are planning on winding your own choke, these taps are desirable in order to allow a wide variety of load impedances to be matched to a given modulator set-up. An ordinary center-tapped choke can be used, but its use is rather limited to a transmitter where the load resistance of the class C amplifier happens to work out at exactly one-fourth of the desired plate-to-plate load resistance into which the modulators are to work. One combination of this sort encountered consisted of a 1 KW final amplifier using four 852s in push-pull parallel, operating at 2000 volts and 500 MA. By ohms law

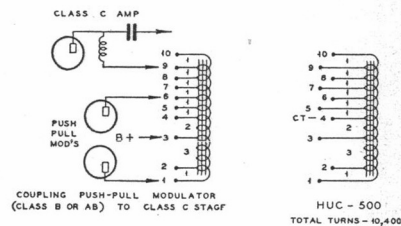
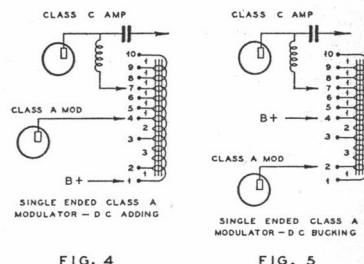

this works out as a load resistance of 4000 ohms. As this load was, in effect, connected across one-half of the output audio choke, the TOTAL reflected load resistance was FOUR TIMES this value, or 16,000 ohms plate-to-plate.

The modulators consisted of a pair of 150Ts. The modulators naturally used the same power supply as the final amplifier, because they are tied together. The desired power output of 500 watts from the 150T modulators worked out very nicely at 2000 volts and 16,000 ohms plate-to-plate load.

Fig. 7 shows the detail of the HUC 500 choke. The total number of turns is 6000 and they are divided as shown. The fractions refer to the proportion of total turns opposite the fractions, and the numbers refer to the actual number of turns between each pair of taps. It is a simple matter to calculate the impedance ratio between any tap combination. The impedance ratio equals the SQUARE OF THE TURNS RATIO. The class C load resistance is connected between the B plus tap and the one other tap that goes to the plate of the RF

amplifier. For example, assume that in Fig. 7 the modulator plates are connected to taps 4 and 5. In this case the B plus lead would go to the midpoint between the two taps, which is tap No. 2. Now let it be assumed that the modulators need a plate-to-plate load impedance of 8000 ohms in order to operate under optimum conditions at the given plate voltage. Let it also be assumed that the final amplifier to be modulated operates under such values of plate voltage and current equivalent to a load resistance of 6,000 ohms. Thus it is desired to transform the 6,000 ohms into 8,000 ohms measured between taps 4 and 5. It is seen that the class C load resistance will be connected between tap No. 2 and one of the outer taps Nos. 5, 3, 6 or 7. Thus the desired IMPEDANCE RATIO is 6,000 to 8,000, which is 3 to 4. In order to obtain the TURNS RATIO it is merely necessary to determine $\sqrt{3}$ to $\sqrt{4}$, which is about 1.7 to 2. As there are 4,000 turns of wire between taps 4 and 5 it is necessary to tap the RF plate to a tap on the choke so that the number of turns from tap 2 to the RF plate tap is to 4,000 as 1.7 is to 2. Thus, about 3,400 turns are required. There are 3,500 turns between tap 2 and tap 7, so the RF plate connection is therefore made to tap 7. It is surprising how hard it is to notice slight mis-matches in modulator load impedance, PROVIDED the load is not below what is termed the critical value. So don't worry about trying to match your modulators and load to the ohm, because a 20 per cent variation from specified values will rarely be noticed. When in doubt, use a load impedance that is too high, rather than one that is too low.

The same type of output choke is very useful in class A single-ended modulator arrangements because it usually allows the common DC dropping resistor and AC by-pass condenser to be eliminated from the circuit. Besides saving the cost of the condenser and resistor it allows the class C amplifier to operate at the same plate voltage as the modulator, which usually allows more efficient operation.

In Fig. 1 is shown a common arrangement using a choke with just one tap. If the choke is center-tapped, the turns and impedance across X and Y are equal and the load reflected into the plate of the modulator is equal to the impedance across X. This is one-fourth of the impedance of the load which is the impedance across X and Y together. The impedance across X plus Y equals FOUR times the impedance across either X or Y alone, when X equals Y. When X is NOT equal to Y the relative impedances are equal to the SQUARE OF THE TURNS RATIOS.

This type of choke is very useful but has the disadvantage that the DC flowing from the power supply to the modulator is flowing in the SAME direction as the DC flowing to the class C modulated amplifier. This means that the core magnetization caused by the two DC currents are ADDITIVE and core saturation is liable to result unless a very large core and air gap is provided in the choke.

This disadvantage is remedied, to a great degree, in the circuit shown in Fig. 2. In this circuit the B plus is fed into the centrally located tap and the modulator is connected to one end and the RF amplifier to the other. Thus the DC to the two stages flows in opposite directions and the magnetization of the core is largely neutralized, with a consequent reduction in the tendency toward core saturation. Core saturation is undesirable because it reduces the inductance of the choke and thus allows the low audio frequencies to be by-passed to ground instead of modulating the RF amplifier, as they should.

Secondary Impedances for Plate to Plate Loads of

P	B	P	Sec.	Impedance Ratios	1,750	3,000	3,500	5,000	6,000	7,000	8,000	10,000
					Ohms	Ohms	Ohms	Ohms	Ohms	Ohms	Ohms	
6	3	1	6	.25	1,500	1,750	2,000	2,500
6	3	1	7	.39	1,180	1,360	2,000	2,350	2,750	3,120	3,900
5	3	2	1	.44	1,320	1,550	2,200	2,650	3,100	3,500	4,400
6	3	1	8	.56	1,700	1,950	2,800	3,500	3,900	4,500	5,600
5	3	2	7	.695	2,100	2,450	3,500	4,200	4,900	5,500	6,950
6	3	1	9	.76	1,350	2,300	2,650	3,800	4,550	5,300	6,100	7,600
6	3	1	10	1	1,750	3,000	3,500	5,000	6,000	7,000	8,000	10,000
5	3	2	9	1.35	2,350	4,050	4,720	6,750	8,100	9,500	10,800	13,500
6	4	3	2	1.55	2,700	4,650	5,400	7,700	9,300	11,000	12,400	15,500
5	3	2	10	1.8	3,150	5,400	6,300	9,000	10,800	12,600	14,500	18,000
6	4	3	10	2.25	3,950	6,800	8,000	11,200	13,500	16,000	18,000	22,500
8	6	4	2	3.06	5,350	9,200	10,700	15,000	18,036
8	6	4	1	4	7,000	12,000	14,000	20,000
10	8	6	1	6.25	11,000	19,000
18	8	6	1	6.25	11,000	19,000

EXAMPLE—A Class C tube, with 1,300 volts on the plate, draws a current of 235 mills. Its Class C load is therefore $\frac{1,300}{.235}$, or 5,500 ohms. The modulator tubes have a plate-to-plate load of 10,000 ohms.

Referring to the chart, select that value which is closest to 5,500 and which appears in the column headed by 10,000 ohms. This is 5600. The terminal connections to be used will then be found in the first four columns at the left end of the line in which the 5,600 appears. These are:

Terminal	P	B	P	Sec.
Tap. No.	6	3	1	8

One common power supply must be used for the modulator and class C amplifier.

Secondary Impedances for Modulator Plate Loads of

B	P	Sec.	Impedance Ratios	750	1,250	2,000	2,500	3,000	3,500	4,500	5,000	6,000	10,000
				Ohms	Ohms	Ohms	Ohms	Ohms	Ohms	Ohms	Ohms	Ohms	Ohms
2	3	1	.11	1,100
4	2	6	.16	960	1,600
4	8	3	.25	875	1,578	1,750	2,100	2,500
3	2	4	.45	900	1,124	1,350	1,575	2,022	2,250	2,700	4,500
3	6	2	.56	1,120	1,400	1,680	1,960	2,520	2,800	3,360	5,600
4	2	8	.64	800	1,280	1,600	1,920	2,240	2,880	3,200	3,840	6,400
8	10	6	1	1,250	2,000	2,500	3,000	3,500	4,500	5,000	6,000	10,000
4	8	2	1.56	1,170	1,950	3,120	3,900	4,680	5,460	7,025	7,800	9,360	15,600
3	2	6	1.78	1,335	2,225	3,560	4,450	5,350	6,230	8,100	8,900	10,680	17,800
2	4	6	1.96	1,470	2,450	3,920	4,900	5,875	6,860	8,820	9,700	11,750	19,600
4	8	1	2.25	1,690	2,815	4,500	5,625	6,750	7,875	10,130	11,250	13,500
2	3	4	2.8	2,100	3,500	5,600	7,000	8,400	9,800	12,600	14,000	16,800
6	10	2	3.06	2,293	3,830	6,130	7,650	9,180	10,700	13,770	15,300	18,370
2	4	8	3.24	2,430	4,050	6,480	8,100	9,720	11,340	14,590	16,200	19,450
3	1	10	4.00	3,000	5,000	8,000	10,000	12,000	14,000	18,000	20,000
2	4	10	4.84	3,627	6,050	9,690	12,100	14,500	16,950
6	10	1	5.08	3,810	6,360	10,160	12,700	15,250	17,800
2	3	6	5.43	4,075	6,800	10,860	13,590	16,300	19,000
4	6	2	6.25	4,690	7,820	12,500	15,630	18,750
3	2	10	7.1	5,320	8,870	14,200	17,750
10	6	2	7.59	5,690	9,500	15,200	19,000
4	6	1	9	6,750	11,250	18,000
2	3	10	13.43	10,100	16,800
6	8	2	15.4	11,550	19,250
10	8	3	16	12,000	20,000

EXAMPLE—A Class C tube, with 1300 volts on the plate, draws a current of 130 mills. Its Class C load is therefore $\frac{1,300}{.130}$, or 10,000 ohms. The modulator tube with 1300 volts on the plate has a plate LOAD of 6,000 ohms.

Referring to the chart, select that value which is closest to 10,000 and which appears in the column headed by 6,000 ohms. This is 10,680. The terminal connections to be used will then be found in the first three columns at the left end of the line in which the 10,680 appears. These are:

Terminal	P	B	Sec.
Tap. No.	2	3	6

One common power supply must be used for the modulator and the Class C amplifier.

The impedance relationships change in this circuit because the output impedance appears across X alone, instead of across X plus Y. The modulator impedance is still reflected across Y.

Thus if the choke were center-tapped so that X equaled Y, then the ratio of load impedance to reflected impedance would be one-to-one.

Fig. 4 shows how the UTC universal output choke is connected for class A single-ended modulation where it is permissible to have the DC currents adding, as was shown in Fig. 1. By choosing different taps for the modulator plate and the class C plate it is possible to obtain a wide range of impedance ratios.

(Continued on page 36)

Comments on Avoidable Tube Failures

By LINEAR

● There have been so many comments on the writer's brief outline of common causes of tube failure, which appeared in the January issue of "RADIO", that herewith an attempt is made to carry further some of the ideas expressed therein.

It is desirable to maintain the space charge in a transmitting tube at a fairly high value because it acts as a protective sheath around the filament and protects it from positive ion bombardment caused by ionization of gas atoms present in practically all transmitting tubes. Many have asked about the source of these gas atoms. If there is a vacuum inside the tube, how can there be any gas atoms present? In the first place, all practical vacuums are relative. A PERFECT vacuum is impossible of attainment. There is always SOME residual gas left in ALL vacuum devices. This can be reduced to an extremely small amount by extensive bombarding during manufacture. Most manufacturers ignite a GETTER inside the tube to clean up as much of the residual gas as possible.

The invention of the GETTER allowed tremendous economies to be effected in the manufacture of vacuum tubes because, through its use, the period of bombardment can be reduced at least 50 per cent. The GETTER has another important advantage. Any transmitting tube whose plate is made of some material other than Tantalum, tends to release gas from the plate during the life of the tube. In other words, it releases gas in normal operation. The use of the GETTER provides a means of absorbing this gas as fast as it is normally released. If these plate materials, such as nickel, graphite and molybdenum could be completely degassed during exhaust, the GETTER could be eliminated. In tubes designed to withstand the beatings and overloads incident to amateur operation it is desirable to eliminate the getter, if possible, because the GETTER turns into a GIVER when heated-up by an overload. In other words, it has only absorbed gas, not eliminated it, and will give up that gas under the influence of heat. The GETTER is usually located in the base of the tube, so that it remains as cool as possible in ordinary operation. However, practically every amateur, at one time or another, detunes something or loses grid bias, thus causing the plate current and plate dissipation to go above the manufacturers' maximum ratings. When the GETTER cools off again it reabsorbs most, but not all of the gas it gave up during the overload. Usually this small amount of extra gas present in the tube due to excessive heating of the GETTER would cause little damage EXCEPT for the fact that in all tubes that require the use of a GETTER, the GETTER is not the only source of gas which is released during an overload. When the plate dissipation is exceeded, the high plate temperature almost always releases a good deal of gas from the plate itself. Due to the fact that overloads of plate dissipation are always accompanied by overloads of plate current, and thus a reduction in the space charge around the filament, it is seen that at the same time that the gas is released the filament is least protected from positive ion bombardment. When the space charge is most needed it is not there, and thus the ionized gas atoms rush right in and "sand-blast" the metallic Thorium coating from the surface of the Thoriated filament, which either reduces or eliminates the filament emission of the tube.

The above remarks apply only to those

tubes that employ a Thoriated Tungsten filament. Tubes with oxide-coated or pure Tungsten filaments are less susceptible to gas ion bombardment or emission poisoning.

It is well to briefly mention the limits at which dangerous amounts of gas are usually released from the common plate materials used in various Thoriated filament tubes.

Tubes with nickel plates should NEVER be allowed to show ANY plate color, because nickel is a very gassy metal and continuously degasses even when only a faint dull red in color.

Tubes with graphite, or carbon plates should practically never be allowed to show color because visible color indicates a dangerously high temperature for this material and will liberate the active gases that can not be removed during manufacture. How-

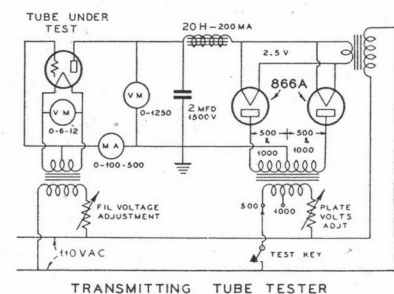

TRANSMITTING TUBE TESTER

ever, carbon is a very effective radiator of heat and practically all manufacturers of carbon plate tubes provide a rather large excess of plate dissipation capacity for a given rating. In other words, a 50 per cent overload in plate dissipation, on a carbon plate 211, for example, usually will not cause the plate to show color, although operation above rated dissipation will ultimately cause trouble as the graphite ages.

Those tubes that use molybdenum plates vary widely in the degree to which the plate material has been bombarded and exhausted, so no set rules can be laid down. In general, the smaller molybdenum plate tubes should not be allowed to show any plate color, while the larger ones, such as the 204A and up, can show a small amount of color with relatively little chance of damage to the filament. However, they should not be allowed to show color continuously (with the exception of certain Western Electric types), because a stray gas molecule will be released someday when the space charge is away on business, and that gas will be ionized and go over and chew on the filament before the GETTER has a chance to absorb it. And another good tube will bite the dust.

Of course all of the Tantalum plate tubes are exceptions because they had to be made gas-free to begin with, in order to get along without a GETTER. They can usually be continuously operated with the plate dull red without fear of releasing gas.

The same rules that apply to plate materials apply to grids and supporting structures. Tubes that have a lot of nickel supports and shields must be protected from overloads, regardless of the plate material, because when the plate heats up so does the rest of the metal. It makes little difference where the gas molecule came from after the tube is flat.

Filament Voltage

Practically all amateurs have had a good laugh at the quaint idea expressed by the tube manufacturer in his tube bulletins that an accurate filament voltmeter should be in the circuit at all times. This attitude was usually explained by the fact that the big tube overload era is a rather recent development. Four or five years ago, the amateur had a great deal more respect for the manufacturers' ratings on tubes than he now has. If all the executives of tube companies who have cursed the day that CUH Perrine was born, were laid end to end! Anyway, the point is this: a filament voltmeter is not particularly important if you keep the plate current down within the limits of conservatism, but when the tube starts pulling 200 MA through an 852 operated extreme class C it is high time to start thinking about filament voltage, or else a new ube will be needed every month or so. By the way, just because W10QRT has operated his 52 at 100 per cent overload for the last two years does not mean that you can do the same thing, because there are 52s and 52s. This holds true for most all tube types.

When in doubt about your filament voltage keep it slightly high. Sometimes 10 per cent too-high filament voltage does less damage to the tube than a filament voltage that is only 1 per cent low, especially when the tube is running wide open.

Flat Tubes

Not one amateur in a thousand knows when his tube starts to go flat. Not until the emission has dropped about 50 per cent does he begin to even doubt the tube. A recent check-up among a number of representative stations showed the surprising fact that over two-thirds of the tubes that were thought to be "as good as new" were, in fact, way below the point caused by 1000 hours of broadcast service in the average BC station. This was in spite of the fact that many of the tubes which were checked had less than 50 hours of service since being purchased. In almost every case it was due to either low filament voltage, excessive plate current, or both.

The important point to remember is that when a tube starts to go flat THE PLATE CURRENT DOES NOT NECESSARILY DROP.

The first sign is a drop in grid current. When this takes place, the operator merely cranks up his buffer stage a few notches until the output is back where it was. Another sign is that the tube shows plate color much easier than when it was new. In other words, it has become harder to excite to a given power output and plate efficiency. This is because the plate resistance rises as a tube goes flat and, as the mu, or amplification factor stays fairly constant, the transconductance drops off. The lowered transconductance necessitates more grid drive to get the same output, so the buffers must work harder. This fact helps to explain why one man drives his 203A with a single 45 or 46 and another man in the same block with the same plate voltage and tank circuit needs a blushing 210 running with 750 volts or so to do the same job. The man who needed the 210 driver probably had a somewhat-flat 203A, although he had the same plate current and the same antenna current. He may even have had the same grid current on his grid meter, but needed a lot more grid power to get the grid current.

The transmitting tube tester shown in the diagram is suitable for use in radio stores.

The average amateur can rig his power supply to get the same approximate set-up. The use of the double-range filament voltmeter and plate current milliammeter allow practically every common type of air-cooled transmitting tube to be tested with a good degree of accuracy. This test will not indicate a coated grid, but it is by far the simplest accurate test for filament emission and you can be sure that there is very little wrong with a tube that can pass this test.

Due to the tremendous variation between ordinary voltmeters and ammeters it is impossible to show a table of plate currents at standard voltages, because it would be very inaccurate. When in doubt about a particular tube, borrow a new one of the same type and compare the two under like conditions.

We hope that someday every dealer in amateur gear will see fit to keep a transmitting tube tester on his counter so that the

CAUSE	EFFECT
Low filament voltage.....	Flat tube.
Too high space current.....	Flat tube.
Too high filament voltage.....	Somewhat shortened tube life.
Plate color (except tubes with Tantalum elements)	Gassy tube.
Gassy tube	Positive ion bombardment.
Positive ion bombardment.....	Flat tube.
Flat tube	Lowered Transconductance.
Lowered Transconductance	More grid drive needed.
General overheating	Internal insulator breakdown and gas generation.
Poor initial vacuum.....	Short life.

condition of tubes can be checked accurately at regular intervals.

Each tube tester should be calibrated against new tubes of each type that are known

to be in good condition. This would not be necessary if it were not for the fact that high voltage voltmeters, as well as milliammeters, vary so widely in their accuracy.

The New RCA-954 Acorn Pentode

(Continued from page 18)

DC Screen Voltage	90	100	V.
DC Control-Grid Voltage	-3	-3	V.
Suppressor	Connected to cathode at socket		
Amplification Factor	1100	Greater than 2000	
Plate Resistance	1.0	Greater than 1.5	Meg.
Mutual Conductance	1100	1400	Mic.
Plate Current	1.2	2.0	MA.
Screen Current	0.5	0.7	MA.

DETECTOR

DC Plate Voltage	250 max.	V.
DC Suppressor (Grid No. 3) Volt.	100 max.	V.
DC Screen (Grid No. 2) Voltage	100 max.	V.



TYPICAL R-F AMPLIFIER CIRCUIT

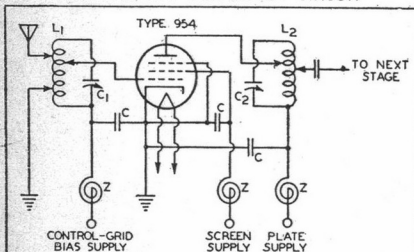

WAVE-LENGTH RANGE	2.75 TO 5.3 METERS APPROX.	1 TO 3 METERS APPROX.	0.8 METER APPROX.
L ₁ , L ₂	N#16 B.C.*	N#16 B.C.*	N#30 B.C.*
	3/8	3/8	1/8
	3/4	5/16	1/8
C ₁ , C ₂ (VARIABLE)	3 TO 25 μF	3 TO 25 μF	3 TO 4 μF
C	100 TO 500 μF	100 TO 500 μF	100 TO 500 μF
Z	15	15	15
	N#30	N#30	N#30
	1/2	1/2	1/2
	S.L.°	S.L.°	S.L.°

*B.C.=BARE COPPER

°S.L.=SINGLE LAYER

NOTE: THE ABOVE DATA ARE NECESSARILY APPROXIMATE FOR ULTRA-HIGH FREQUENCIES, COILS L₁ AND L₂ MAY BE TAPPED AT SUITABLE POINTS DETERMINED BY TEST TO REDUCE EFFECT OF TUBE LOADING ON CIRCUIT IMPEDANCES. SINCE ELECTRONIC PLATE LOADING IS NOT SERIOUS IN A PENTODE, THE USE OF COIL L₂ WITH TAPPED PLATE CONNECTION MAY NOT BE NECESSARY TO GIVE SATISFACTORY RESULTS. THE CONDENSERS SHOULD ALL BE OF HIGH QUALITY AND BE DESIGNED FOR ULTRA-HIGH FREQUENCY OPERATION.

TYPICAL TUBE-VOLTMETER CIRCUIT SPECIALLY ADAPTED FOR PROBE ARRANGEMENT

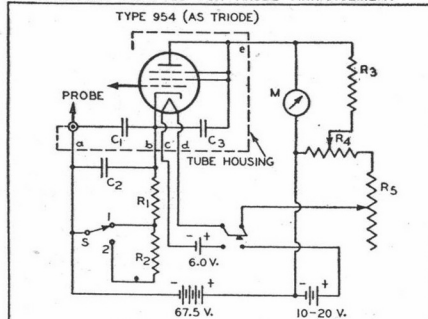

C₁ = 500 μF CONDENSER (MICA)
 C₂ = 16 μF COND. FOR CALIBRATION WITH AND MEASUREMENT OF LOW FREQUENCIES
 C₃ = 500 μF CONDENSER (MICA)
 C₄ = MICROAMMETER (50 OHMS APPROX.)
 R₁ = 2000-OHM RES. (WIRE WOUND)
 R₂ = 50,000-OHM RES. (WIRE WOUND)
 R₃ = 10,000-OHM RES. (WIRE WOUND)
 R₄ = 40,000-OHM POTENTIOMETER FOR COARSE ADJUSTMENT IN BALANCING OUT PLATE CURRENT
 R₅ = 2,000-OHM RES. (VARIABLE)
 S₁ ON POSITION 1 GIVES RANGE OF 2 VOLTS RMS
 S₁ ON POSITION 2 GIVES RANGE OF 14 VOLTS RMS

NOTE: LEADS b, c, d AND e RETURN INSIDE CABLE. LEAD a IS CONNECTED TO GROUNDING HOUSING.

CONSTRUCTION OF PROBE

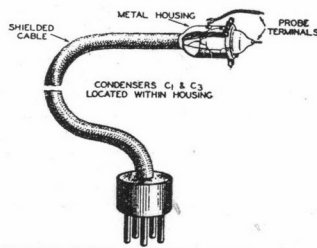

Typical Operation as Biased Detector:

Heater Voltage	6.3	V.
Plate-Supply Voltage	250	V.
DC Screen Voltage	100	V.
DC Control-Grid Voltage	-6 approx.	V.
Suppressor	Connected to cathode at socket	
Plate Load	250,000 ohms or equiv. imped.	
For resistance load, voltage at the plate will be less than the plate-supply by an amount equal to the voltage drop in the load resistor caused by the plate current.		
Plate Current	Adjusted to 0.1 MA	with no input signal.

HAM HINTS

Are Your Rectifiers Calibrated?

● A visit to a station owned by an outstanding victim of the lately lamented business depression showed a complete lack of meters with which to tune up the transmitter. The final amplifier used a carbon plate tube and the operator could not judge by the color of the plate whether or not the plate tank was tuned to resonance. Not even a flashlight globe was available. Upon being questioned the operator showed us several marks painted on the side of one of his 866 rectifiers. He then showed how the height of the ionization varied in the 866 as he tuned the plate tank, showing resonance as the ionization dipped to a low. He even had the marks calibrated in steps of 50 MA up to 400 MA. Incidentally, this same operator is that hardy soul who used to neutralize his final by holding his hand across the plate tank of his 211, then vary the neutralizing condenser with his other hand until he could feel no RF through his moistened fingers. He was abruptly cured one day when he inadvertently sat on the key (primary keying) while neutralizing!! ...

Where Should the Tuning Dial Go?

● Several receiver manufacturers have recently asked our opinion for the best location of the tuning dial on a super het designed for Ham use. The majority seem to prefer the dial at the extreme left side of the receiver. Thus the receiver can be directly in front of the operator while tuning with the left hand, the right hand being used to operate the key, assuming that the station can operate break-in, as all stations should in this enlightened age.

This arrangement may not look as symmetrical as when the tuning dial is placed in the center, but it is certainly more convenient.

X vs. Y

ALTHOUGH MOST ANY X cut crystal, and practically all PROPERLY GROUND Y cut crystals, will show but one peak when used with a low "C" oscillator tank, it is a good idea when grinding a plate for use in an oscillator with a high "C" tank, to select an X cut blank, and not to make to contour TOO concave.

A New Development in Plate Coupling To Audio Transformer

By W. W. WAHLGREN*

• There has long been a need for a practical and economical method of coupling to the plate of a single-ended audio amplifier tube. At present the situation is met by using an average quality audio transformer, if the requirements are not rigid, or perhaps the use of a large expensive transformer when better quality is desired. In either case the performance of the transformer is hampered by the presence of the polarizing plate current.

This polarizing current has two effects on the operation of the amplifier. First and foremost, the inductance of the transformer is reduced to about one-third the value obtainable with the same materials under conditions entertaining no polarizing current. This, of course, seriously reduces the response at low frequencies. In the case of high plate resistance voltage amplifiers, it entirely precludes the use of transformers for satisfactory coupling. The other effect is not often considered but is nevertheless present, i.e., distortion caused by unequal permeability on the positive and negative voltage peaks. This results in an even harmonic distortion or a peaking of one lobe and a flattening of the other, and is especially present when the degree of polarization is great, as in power amplifier transformers. Thus it is seen that it is very desirable to eliminate or counteract this polarizing current.

In a push-pull plate circuit the polarizing effect is not present because the plate currents of the two tubes counteract each other.

In its simplest form this new device merely consists of bleeding, through a resistor and a tertiary winding to the cathode, enough direct current to neutralize the ampere turns of plate current. For example, take a transformer designed to work out of push-pull 56s. Connect one-half of the primary to the plate circuit of the tube in the conventional manner. Then compute the (static) DC plate resistance of the tube at the working condition, which is equal to the plate voltage divided by the plate current (no signal). Thus $\frac{250}{.005} = 50,000$ ohms. This is the

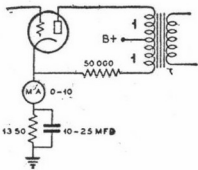

Circuit using a 56 in the balanced bucking circuit

value of a resistor which should be connected directly from the other plate terminal on the transformer to the cathode. This will permit 5 milliamperes to flow in each half of the primary in opposite directions, thus balancing out the polarizing current.

Now, the performance of the transformer is maximum and the step-up ratio is double that of the push-pull connection. The 50,000 ohm resistance is reflected at a unity ratio to the primary and so loading the transformer as to give a much flatter response over the whole audio range. If this tube is self biased, then we have 10 milliamperes in the cathodes resistor which would now have to be 1,350 ohms, or one-half the previous

value. The 5 milliamperes which flows from the depolarizing resistor is, of course, just as steady as the plate voltage. Accordingly the bias voltage fluctuation, due to the AC component of the plate current, is reduced to one-half. This improved bias then allows more actual output from the tube, for a given set of conditions.

The above example is satisfactory from a voltage amplifier standpoint, but is not very suitable when one must consider the power transfer efficiency of the transformer. This, of course, is because the depolarizing resistor consumes a good portion of the power output. This effect may or may not be desirable, depending upon circuit conditions. The power transfer efficiency of the system is affected by the location of the plate voltage tap on the transformer. In the above example the tap was at the center of the winding. Consider a case where the tap is at the one-third point. This means that there are twice as many turns in the plate circuit as in the depolarizing circuit. In order to now balance the transformer there must be a depolarizing current equal to twice the plate current, and the ampere turns in each section are equal. If the same tube is used, as before, with 5 milliamperes plate current, then the depolarizing current must be 10 milliamperes, making a total of 15 MA drawn from the power supply. Now the bias voltage is even more constant. In order to draw 10 MA a 25,000 ohm depolarizing resistor must be used. The turns ratio between turns ratio.

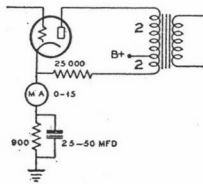

Showing connection for a 56 audio amplifier using a 2-to-1 bucking ratio.

the two sections of the winding is two to one, so the impedance ratio will be that squared, or four to one. This 25,000 ohm load will then reflect into the plate circuit as a 10,000 ohm plate load. Now, of course, the power loss will be more nearly negligible. If the

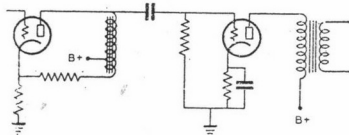

Method of coupling 2A6, 75, 24, 79, etc., to following stage.

ratio between the windings is greater, then the reflected load is higher, because the impedance ratio varies as the square of the turns ratio.

As was indicated above, one of the greatest advantages of this system is in being able to match some of the high resistance

tubes such as 2A6, 75, 24, 79, etc. In order to obtain good response from a voltage amplifier which has no resistance loading, the resistance must be two times the plate resistance of the tube.

Thus in matching a 2A6 tube having a plate resistance of 90,000 ohms, Z_L must be more than 180,000 ohms in order to obtain maximum amplification. Any frequencies at which the product of ($2\pi fL$) was less than this would not be amplified as much as the higher frequencies. For instance, find out what inductance would be required to give a flat response down to 40 cycles when using a 2A6 tube as an interstage amplifier and having no resistance load. For this condition

$$Z_L = 180,000 = 2fL, \text{ or } L = \frac{180,000}{2\sqrt{(40)}} = 720$$

henries approximately. Also bear in mind that there will be about 3 MA plate current. Only a very large and costly audio transformer could accomplish this.

The problem is somewhat simplified if a loading resistor is used to lower the maximum gain of the stage. Suppose a 250,000 ohm resistor is placed across the primary of the transformer or inductance. This puts an upper limit on the load impedance to the tube, even when the reactance is infinite. The load reactance can drop to 140,000 ohms before the decrease in response exceeds 1 decibel; at 40 cycles this would require an inductance of 560 henries.

Thus it is seen that by sacrificing 25% gain, only three-fourths as much primary inductance is needed. The lower inductance requirement makes it materially easier to obtain a good high frequency response. Also the loading resistance helps to reduce resonant peaks in the response curve. The above example is given to demonstrate that it is not disadvantageous to have any audio stage loaded with resistance, as must be the case when employing this depolarizing system.

In high permeability alloy core transformers, the polarizing current is especially undesirable because it reduces the high permeability to a level not a great deal better than silicon steel core transformers. The application of this depolarizing principle is very great in connection with transformers of this type.

Summarily, high-fidelity response is obtained only at a premium, when transformers are used to work out of single voltage amplifier tubes. Common practice is to use either resistance coupled or push-pull amplifiers when high gain and high fidelity response are required. Both of these systems have undesirable features. Transformers are ordinarily out the question when working out of high plate resistance tubes. Thus the need for something new is evident. The situation is met by this depolarizing system, as is shown by the following conclusions.

1. Large inductances are obtainable in small inexpensive transformers or audio chokes. This allows good efficiency over the whole sonic register.

2. System is applicable to any tube where the necessary depolarizing current is acceptable. This depolarizing current also serves as a bleeder load.

3. The depolarizing resistor may be used as a major load resistance or as a very minor load resistance.

(Continued on page 31)

* Engineer, Gardner Electric Co.

Amateur News

The Amateur's Legion of Honor

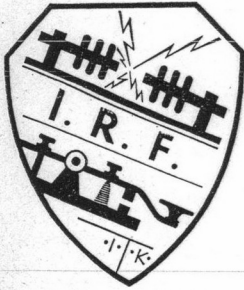

This department is edited by the President of the International Radio Fraternity, J. Richard Meloan (Jo) radio W6CGM-W6ZZGB, KERN. All communications concerning the International Radio Fraternity, as well as inquiries from any amateur as to the Requirements for Membership, should be addressed to I.R.F.

Headquarters, International Radio Fraternity, 2705½ South St. Andrews Place, Los Angeles, Cal.

I.R.F. Contest

THE International Radio Fraternity is sponsoring its second annual QSO contest during the month of April. If you listen for the sign of "IRF" included in a CQ call, it signifies that the operator is looking for an I.R.F. brother. It is hoped that this contest will far exceed the one of 1934 because the membership of I.R.F. has increased 100 per cent since that time. The dates and requirements of the contest are as follows: Contest starts at 10:00 PST Sunday, April 14, and finishes at 10:00 P.M. PST Sunday, April 21. Don't forget the dates. The prize, which is to be a 801 tube, will be awarded as soon as the results are judged. In making up the list, copy it from your log, just as it is written therein, showing time, call, report, etc. Let's show the amateur world that the I.R.F. is a live and active fraternity with the good intentions of regaining some of the lost privileges of the amateur.



BRUCE PETERSON, W6JWL

An I.R.F. member, licensed when 15 years of age, Bruce Peterson, W6JWL, has a rig that any amateur would be proud to own. He "took the air" on November 5, 1933. Worked 40 states on 80 meters. Figure it out—that's one state for every two meters. The transmitter then used a pair of 46s in PP. Not content with DX conditions on the 80-meter band, W6JWL looked forward to the time when he would own a high-power final. Big tubes cost big money, so W6JWL was forced to go to work. Now his dreams have come true, for he has a rack-and-panel job, an 852 in the final and a 9-tube crystal filter superheterodyne.

The photo shows his station . . . built by W6JWL himself. For a 16-year-old amateur, he has done exceptionally well, don't you think? He has worked 23 countries in 5 continents. The transmitter line-up is as follows: 47 xtal, 45 doubler, 830B buffer and 852 final with 425 watts input.

I.R.F. Divisions

IT MAY interest the reader, if he is not already a member of the fraternity, to know that the I.R.F. structure consists of eleven divisions in the United States, as follows: Southern Division: Comprising Arkansas, Mississippi, Alabama, Tennessee, Kentucky, and Louisiana. Everglades Division: Florida, Georgia, North Carolina, and South Carolina. Capitol Division: Pennsylvania, West Virginia, Virginia, District of Columbia, Maryland, and Delaware. East Coast Division: Connecticut, Massachusetts, Vermont, New Hampshire, and Maine. Atlantic Division: New York, New Jersey, and Rhode Island. Olympia Division: Oregon, Washington, and Alaska. Continental Division: Montana, Wyoming, Utah, Colorado, and Idaho. Border Division: New Mexico, Texas, Oklahoma. Central Division: Kansas, Nebraska, North Dakota, South Dakota, Missouri, and Iowa. Great Lakes Division: Illinois, Minnesota, Wisconsin, Michigan, Indiana and Ohio. West Coast Division: California, Arizona, Nevada, Hawaii, and Philippine Islands. There is a Division Chief in each Division and he is very active on the air. He reports to headquarters monthly, any information published in a monthly bulletin which is sent to all I.R.F. members.

I.R.F. Pin

IRF men identify themselves by wearing a small I.R.F. insignia pin. The pins are made in different colors, according to membership rating. The organization structure is as follows: Junior membership, consisting of any desirable licensed amateur, approved by the Membership Committee. This class of members wears the green and gold insignia fraternity pin. The ORDER OF ITK is the Degree Section, which consists of selected skilled amateurs. The ratings in the Degree Section are "Knight of the Key", wearing the insignia pin of white and gold; "Sparks", wearing insignia of red and gold; "Lightning Jerker", wearing blue and gold insignia. The highest degree is the Honor Degree, wearing an all-gold insignia pin. The Honor Degree is awarded only to men who, by some means of amateur radio, have saved either life or property.

IF THE reader would desire further information or application to the International Radio Fraternity, he should write to Mr. K. Isbell, Secretary, 2705½ South St. Andrews St., Los Angeles, Calif.

Southern California I.R.F. Chapter News

W6HDV, Raymond Stevenson, a new IRF member, recently worked a European and now qualifies for WAC. CFIGU, Portugal, was the lucky catch on 7 MC.

W6JWL is now signing W6LTI as a portable call at his new location.

W6JWL uses an 852, while W6LTI has three watts to final 45 TNT, and works East Coast.

W6GAT and his YL, W6HEG, have not been heard in the last few weeks because they have moved their QRA to Manhattan Beach, California. The OM is busy building a phone transmitter.

ZS2A is heard every night putting an R6 signal out here on the coast.

W8CRA heard working his usual nice DX. CT2BK, Azores, is adding a new country to lots of the W6 gang. He is on about 7,000 KC, from 6 to 10 PM. W6CXW, W6QD, W6BIF, and W6WO have had recent QSOs with him.

W6WO reports 14 MC has been very good recently for European contacts. During the first three days of the contest, 40 South Americans and 20 Europeans were heard on the 14 MC band. The African gang have been coming through nicely at nights on 7 MC. Now is the time for prospective WAC hams to snag that long-sought missing continent.

The Seventh International Relay Competition has certainly created a riot in the 7 and 14 MC bands. It would appear that every active ham has entered this contest and the result is that conditions on both these bands are making DX contacts very difficult. The 7 MC band is by far the worst. It is very evident that our amateur bands must be widened as soon as possible. Any person who listened to the unholy mess on 7 MC during the contest will agree that something must be done.

W6EXQ is now using an EIMAC 150T in his final amplifier with excellent results. A recent visit to W6CXW, by the writer, disclosed a nice rig using a Gammatron buffer stage exciting a pair of EIMAC 150Ts in parallel. A glance at the wallpaper shows an enviable DX record with European and African contacts a common event.

W6CVF is busy building a seven-stage rack and panel affair using a pair of 852s at one KW input. W9EQG of Chicago, recently spent several weeks visiting the W6 gang on his vacation. W6DLN has been QRL due to studies at U. S. C. A heavy wind blew his sky wire down so he was forced to put the ole pole up again.

We'd Like to Have You Meet

FRANK C. JONES, W6AJF, of "RADIO"



- A Licensed Radio Amateur since 1921.
- His University of California Thesis on 1½ and 3 Meter Directional Radio was prepared in 1924-25.
- Transmission Engineer for the Pacific Telephone and Telegraph Company from 1925 to 1928.
- Consulting Engineer from 1928 to 1934.
- In charge of engineering, Gilfillan Bros., Inc., Los Angeles, 1928 to 1931.
- In charge of engineering, Echophone Radio Mfg. Co. of Waukegan, Illinois, from 1931 to 1932.
- Loudspeaker design for Jensen Radio Mfg. Co. and for the Rola Co.
- Consulting Engineer for Remler Co. of San Francisco.
- Post-Graduate studies at University of California intermittently from 1928 to 1931.
- Short and ultra-short wave specialization and engineering from 1933 to 1934.
- Writer of technical magazine articles under his own name as well as his pen names, Churchill and Donaldson, from 1924 to 1934.
- Developed the first midjet BCL superheterodyne that was marketed.
- Popularized the present-day 5-meter super-regenerative circuit in 1928.
- Developed the cathode-antenna combination volume control used in nearly all radio receivers prior to the advent of AVC.
- His amateur radio station, W6AJF, was the western terminus of the first trans-continental 20-meter test with John L. Reinartz.
- Now in charge of ultra-short-wave and high-frequency receiver and transmitter design for the magazine "RADIO."

Autodyne Receiver-Monitor

● The old reliable regenerative autodyne receiver is still widely used in spite of the growing popularity of the superhet. In a quiet location where there is not much local QRM or QRN, the two tube autodyne, consisting perhaps of a 6C6 detector and another 6C6 (Triode) peaked audio amplifier allows one to hear any CW signal that is audible on any but the very best supers. However, if any local power line noise is present it is rather difficult to keep it out of the autodyne unless certain precautions are taken.

While a regenerative detector can be made tremendously sensitive, it is also subject to overload, particularly from noise. This overload manifests itself by cross modulating any signal that is being received.

Users of older types of autodyne receivers tried to minimize this tendency to both overload and "flatten-out" by providing a volume control to reduce the RF input from the antenna. In order to prevent the volume control from seriously detuning the detector, it was found necessary to provide a tuned RF stage which added no perceptible gain in itself, but fairly effectively isolated the detector from the volume control. The tuned RF stage required the use of long leads and rather clumsy shielding to minimize interlock between the RF and detector controls, and accurate tracking for single dial control is still a dream.

The best answer to all of these difficulties seems to lie in the elimination of both the RF stage and the resistance volume control. In place of these two "lossers" I recommend the use of efficient twisted pair feeders from a doublet, cut to length, plus a Faraday Screen between the antenna coil and the detector grid winding. The coupling between the antenna primary and the grid secondary should be variable, which represents a volume control that INCREASES the selectivity when the gain is reduced, rather than reducing it, as does the volume control in the conventional RF stages.

The last and most important point is to use LITERALLY WATERTIGHT SHIELDING around the entire receiver. One of the best ideas I have seen is to use two tight aluminum boxes, one inside of the other. The inner box is about a six-inch cube and contains the receiver proper. It is attached to the front panel of the outer box and touches the outer box at no other point. The detector coil is changed through a hole in both front panels. The outer box is about 12"x12"x8" high and contains 135 volts of B batteries as well as the variable antenna coil and its control shaft. The Faraday screen is mounted over a hole cut in the left side of the box so that there is double shielding around everything but the antenna coil.

Shielding the B batteries is very effective in eliminating power line and other local noise and allows the receiver to act as an exceptionally good monitor, with the antenna disconnected. The tube heaters are operated from an AC filament transformer mounted several feet away and well grounded.

A successful "two tuber" is largely a mechanical problem and the results that can be obtained more than justify the time and trouble necessary to obtain perfect shielding and isolation.

Wanted, a Yardstick of Crystal Performance

● As every operator knows, there is a tremendous difference in Piezo-electric crystals. Some oscillate readily, others only with the greatest of difficulty. Some have only one important resonant peak, others have several bad peaks close to the main resonant peak. There is also a great difference between the SHARPNESS, or selectivity of the main reso-



Ham Hints

— By JAYENAY —

nant peak, which might be expressed as the "Q" of the crystal. A method of rating quartz and other crystals should also take into consideration the RF resistance of the crystal, which affects the amount of feedback necessary to cause or sustain oscillation. There should also be some method of defining the power which the crystal can safely dissipate, or the power which it can control without fracturing.

The New 6B5 Triple Twin

● This new double triode (From Triad) represents an improvement over the Triple-Twin type of direct-coupled amplifier tube, such as the 2B6. The principle difference between the 6B5 and the 2B6 is the fact that the cathode of the first stage and control grid of the second stage, which are tied together, are not brought out to a base connection, but float at a potential determined by the grid current of the second stage. The control grid of the second stage is normally somewhat positive, with respect to its cathode, so that the output triode can be said to operate either class AB, class B or even class A, depending on your own pet definitions.

Anyway, the device works and deserves to be copied by the other tube manufacturers because it looks like a very good answer to the receiver output tube problem.

As the average plate current drawn by the second, or output triode varies from 10 to 15% with the audio signal, audio harmonics are generated, as in any single-ended audio amplifier that operates somewhere near the class B region. However, these audio harmonics are neutralized by similar, but opposite phase harmonics produced in the first stage. The heater is 6.3 volts at .8 amps and the tube can deliver a clean 4 watts into a 7000 ohm load. Thus most of the better pentode output transformers can be used with this tube. 15 volts (RMS) of audio signal is necessary to obtain full output. The input circuit draws no grid current and thus no driving power is required. The voltage gain through a single 6B5 is slightly above 11, which is approximately 21 DB. This is somewhat more gain than can be obtained from any of the usual types of audio power tubes. This is at a plate voltage of 300 volts. The output can be increased somewhat by raising the plate voltage to 400 volts and by placing 12 volts of bias on the input grid. The push-pull circuit is recommended for 400 volt operation and 20 watts of audio power is obtained across a 10,000 ohm plate-to-plate load.

Antenna Costs

● At a rough guess, I would say that the average Ham station represents about \$250 worth of equipment and labor, of which about \$5, or two per cent, can be charged against the antenna and feeders.

Because the effectiveness of the antenna can vary as much as 1000-to-1, it seems to me that improving the antenna represents the cheapest way to increase power. A half wave doublet, a half wave high, is hard to beat. Twisted pair feeders and poles are cheap.

Keying Systems

● A brief outline of the advantages and disadvantages of various keying systems has been requested, so here it is.

Primary Keying

Advantages: Allows the use of grid-leak bias on the keyed stages. Eliminates clicks and safeguards the filter condensers used on the keyed stages. Eliminates the necessity for a high voltage bleeder. Eliminates back-wave 100%, if more than one stage is keyed.

Disadvantages: Requires a heavy current relay that can break an inductive AC circuit. Tends to blink the lights when used on high power. Sometimes creates bad thumps in BCL sets on the same line, caused by 60 cycle AC surges. Makes perfect keying at high speeds difficult due to the tendency of the filter condensers to add tails to the dots.

Center-Tap Keying

Advantages: Allows the use of grid-leak bias on the keyed stage, but separate bias must be used on all succeeding stages. Will follow a "bug" perfectly. Easy to read. High voltage, low current DC relays are relatively cheap.

Disadvantages: Can cause bad key clicks unless a good click filter is used. Can also cause bad thumps unless a rather heavy bleeder is used across the high voltage. The bleeder is also necessary to protect the filter condensers from failure when the key is up.

Tube Keying

This is a special type of center-tap keying that eliminates clicks and thumps and yet will key at high speed. Wastes some plate voltage and requires a keying tube that can pass the full plate current of the keyed stage. This is one of the best keying methods known and is widely used by the commercials.

Blocked-Grid Keying

Advantages: Usually requires no keying relay and the keying circuit passes practically no current, which eliminates clicks.

Disadvantages: Requires a separate bias supply to provide the grid-blocking voltage. All succeeding stages must have fixed bias (no grid leaks). Usually requires a back contact key.

Keying the Oscillator

This is not a type of keying but a place to key. It justifies special mention because it seems to give the best results, at the present time.

Advantages: Allows complete break-in and completely eliminates back-wave. Practically eliminates clicks and thumps and will key at high speed.

Disadvantages: Requires fixed bias supplies for all the amplifier stages. Is apt to chirp, unless the screen voltage for the crystal oscillator tube is provided from a voltage divider, rather than from a series resistor. Requires an active, quick starting crystal and the crystal oscillator must be adjusted for quick starting, which slightly reduces the oscillator output. The best place to key a crystal oscillator is in its center-tap.

Inductive Coupling for Five Meters

● As the use of neutralized power amplifiers becomes more common on five meters, it is necessary to pay particular attention to methods of interstage coupling. Link coupling is being used with some success, but it is difficult to get the impedance of the link down low enough to avoid troublesome losses. The use of capacitive coupling requires high C tank coils due to the large shunt capacitances.

Thus pure inductive coupling is becoming justly popular because it allows a good impedance match to be obtained with low C tank coils. As with all the conventional inductive coupled circuits, there will be some interaction between the two tuning controls.

EIMAC Tubes—More Power, Less Grid Drive

March of Progress

Controlled-Carrier Modulation with Linear Class B Radio Frequency Amplification. . .

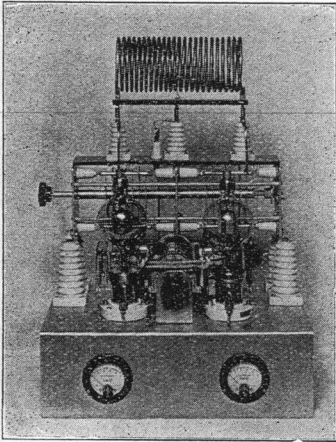

• Even though we prefer to report progress which enables better results to be obtained from more and bigger tubes, in fairness to progress we recognize Controlled-Carrier Modulation as having possibilities of marked transmitter economy. The most recent developments in the field of Controlled-Carrier Modulation utilize a low power plate modulated Class C Amplifier whose average carrier output is varied in accordance with the speech SYLLABLES applied to the microphone. This relatively small controlled-carrier output is then amplified to whatever power level is desired, by means of one or more Class B linear Amplifiers. These linear amplifiers differ from conventional Linear Amplifiers in that a given amount of tube capacity allows from 2 to 4 times the conventional Linear Amplifier output to be obtained.

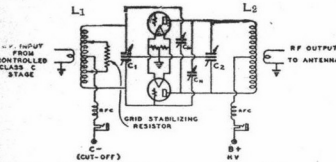

This is because the Linear Amplifier, operating with a variable carrier, always operates at high plate efficiency. It might be said that the Linear Amplifier modulates itself and thus requires no expensive high-level modulator tubes, transformers and power supply. A pair of EIMAC 50T tubes used in such a Linear Amplifier can give an equivalent carrier output of more than 150 watts! A pair of EIMAC 150T tubes will give an equivalent carrier of more than 500 watts! Savings effected by the elimination of the high-level modulation equipment can be utilized to increase the tube capacity of the final amplifier. The answer—"More Watts per Dollar."

No. 1
of a
Series
of 12

Your Problems—and Their Solution POWER GAIN—

POWER GAIN is the ratio between the driving power applied to the Grid and the useful output power supplied to the Antenna. Practically all transmitting tubes are used as Power Amplifiers, not voltage amplifiers, and thus it is desirable to choose a tube which is the best amplifier of radio-frequency power.

The grid excitation power is used solely for the purpose of controlling plate power. It controls the conversion of DC plate power into radio-frequency output power. None of the grid driving power ever reaches the antenna or gives any useful radiation. Therefore, if the same output can be obtained from an amplifier stage with less grid excitation, it is desirable to do so for reasons of economy. Small driver tubes certainly cost less than large tubes; the use of smaller power supplies is an added advantage. The present widespread use of ultra-high-efficiency in the final amplifier often defeats its original purpose. The economy of using a small tube in the final amplifier, operating at ultra-high plate efficiency, is offset by the necessity for a multitude of expensive, high-power driver stages between the crystal oscillator and the final amplifier. In some cases, it has been found that 150 watts of grid driving power is required to secure a nerve-wracking 450 watts of output in the final amplifier. The reason for this condition is the fact that most conventional tubes were not designed to operate at ultra-high plate efficiency. Obviously the recent development of a tube which permits the same 450 watts of output to be obtained, but which requires only approximately 1/10th the aforementioned amount of grid-driving power to obtain this 450 watts of output, will result in tremendous overall economy in both tubes and power supply equipment. In order to secure this power gain from a tube it is essential that the tube have two important characteristics: (1) A high transconductance, which means that the grid must have a very high degree of control over the plate current. (2) The grid current curve must be low and flat, which means that when driven positive the grid must accelerate the electrons without intercepting very many of them. These two characteristics are outstanding in the EIMAC series of ultra-modern low and high power transmitting tubes. An EIMAC 150T tube in a final amplifier designed for 450 watts OUTPUT can be successfully driven by a link-coupled 210 driver stage. Likewise, an EIMAC 50T tube can be driven to 150 watts OUTPUT by a link-coupled 45 driver stage. Only in EIMAC Tubes will you find the combination of ideal characteristics which make possible this permanently superior performance. At high or low plate voltages, at high or low frequencies, for economical operation, for ability to withstand overloads—in short, for better all-around satisfaction, the wise man now chooses EIMAC.

The following stations are representative of the hundreds of amateurs using EIMAC'S in the final amplifier: K6BAZ, W9GHY, WIHE, W7BCI, XIAM, W9BHT, W5CCB, W6CXW.

Conservative Ratings

50T

50 Watts of Available Plate Dissipation . . .
30 Watts of Filament Power!

CHARACTERISTICS
Fil. Voltage 5V; Fil. Current 6A; Rated Plate Dissipation 50W; Amp. Factor 13; Max. Plate Current 100MA. Plate Voltage 1000 - Power Output 75W. Plate Voltage 2000 - Power Output 150W. Plate Voltage 3000 - Power Output 250W.

150T

150 Watts of Available Plate Dissipation . . .
50 Watts of Filament Power!

CHARACTERISTICS
Fil. Voltage 5V; Fil. Current 10A; Rated Plate Dissipation 150W; Amp. Factor 13; Max. Plate Current 200MA. Plate Voltage 1000 - Power Output 75W. Plate Voltage 2000 - Power Output 300W. Plate Voltage 3000 - Power Output 450W.

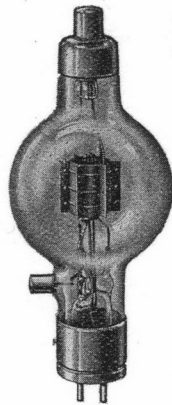

EIMAC 50T

Net - - - \$13.50

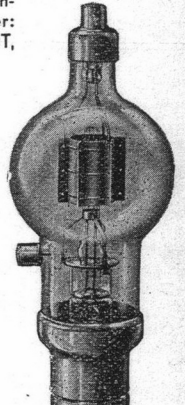

EIMAC 150T

Net - - - \$24.50

EITEL-McCULLOUGH, INC.

SAN BRUNO, CALIFORNIA, U. S. A.

Write us if you can't get EIMAC'S from your dealer

Ann Arbor, Mich. Dick & Purchase.
Atlanta, Georgia. Wholesale Radio.
Boston, Mass. The Radio Shack.
Butler, Missouri. Henry Radio Shop.
Chicago, Illinois. Allied Radio Corp.
Cleveland, Ohio. Midwest Radio Mart.
Dallas, Texas. Northern Ohio Labs.
Denver, Colorado. Porter T. Bennett.
Fall River, Mass. Interstate Radio.
Cushman Radio Svc.

Fayetteville, N. C. Hunter Brothers.
Fresno, California. Ports Mfg. Co.
Honolulu, T. H. Inter-Island Radio.
Jamaica, Long Island. L. I. Marine-Electric.
Kent, Ohio. Kladag Radio Lab.
LaCrosse, Wisconsin. SOS Radio Supply.
Little Rock, Ark. Vinson Radio Co.
Los Angeles, Cal. Radio Supply Co.
Memphis, Tennessee. Viser Radio Serv.

Newark, New Jersey. Wholesale Radio Svc.
New Orleans, La. Shuler Supply Co.
New York City. Gross Radio, Inc.
Oakland, California. Electric Supply Co.
Oklahoma City, Okla. Southern Sales Co.
Orlando, Fla. Radio Accessories Co.
Peoria, Illinois. Radio Mfg. Engrs.
Portland, Maine. Bartlett Radio Co.

Portland, Oregon. Wedel Company, Inc.
Rochester, N. Y. Beaucaire-Mitchell.
St. Louis, Missouri. Walter Ashe Radio.
St. Paul, Minnesota. Lew Bonn Company.
San Francisco, Cal. Offenbach Electric.
San Jose, California. Radio Specialties Co.
Seattle, Washington. Seattle Radio Supply.
Spokane, Washington. Spokane Radio Co.
Toronto, Ont. Canadian Tire Corp.
Tulsa, Oklahoma. Kay Radio, Inc.

REVIEW of Factory Receivers

The Patterson PR-12

• The growth of the high-frequency radio field and the interest associated with it has caused the development and sale of a large number of receivers which purported to be the last word for high-frequency reception. Most of these receivers were hurriedly thrown together and many receiver manufacturers labored under the impression that any super-heterodyne would "get by" if it tuned to the short waves. Many of the first high-frequency supers were subject to one or more of the following faults—High inherent background noise. Poor bandspread, without calibration. High-C tuning circuits. Poor fidelity. Limited range AVC. Oscillator instability. Poor Tracking, which, in turn, made for poor selectivity. Poor tracking was also responsible for bad image response. The use of high IF frequencies around 500 KC caused much unnecessary cross-talk from commercial and ship stations, in some locations. Poorly matched crystal circuits reduced the sensitivity and introduced humps on each side of the peak.

Several of the new receivers have demonstrated that engineers have appreciated these shortcomings and steps have been taken to correct them. The Patterson PR-12 is one example of the more modern and better engineered receivers for high frequency reception.

The first feature of the PR-12 is the use of five sets of coils to cover the range of from 540 to 35,000 KC. The coils are switched through a six-gang assembly which switches the primary, as well as the secondary of each coil.

No attempt is made to short-circuit the unused coils. Quite extensive shielding is

used between the coils for reducing the image response. The tuning arrangement is somewhat unusual in that a six-gang variable condenser is used. In the broadcast band between 540 and 1650 KC, each pair of stators is placed in parallel, giving the effect of a single, large 3-gang condenser. On the high frequency bands only three of the six sections are used, and the three condensers are of rather low-C, which aids the sensitivity of the receiver. Each oscillator has a separate tuning condenser and the two lowest frequency oscillator coils have their own series padding condensers as well. The radio-frequency amplifier is a 6D6, which is subject to AVC control as is the first detector and oscillator, which is a 6A7. A rather new crystal circuit is used between the first detector and the first IF amplifier stage. It permits series or parallel operation, or off position for the crystal. There is an impedance matching transformer to match the impedance of the crystal to the grid of the first IF amplifier. There are three IF stages, all using 6D6 tubes, and there are eight tuned circuits in the receiver, which should provide enough gain and selectivity for any purpose.

The beat-frequency oscillator is another 6D6 used in the Dow circuit, the output of which is coupled to the control grid of the third IF amplifier through a shielded lead.

The second detector is an '85 tube, one diode of which is used for audio demodulation and the other diode is used to provide AVC voltage. A 6F7 is used as a double vacuum tube voltmeter, one portion of which indicates signal audibility, or field strength, and thus acts as a tuning meter, and the other

portion of the 6F7 tube provides a means of estimating percentage modulation on any phone carrier. One meter is used to indicate both radio-frequency and audio-frequency levels and is switched from one circuit to the other by means of a double-pole-double-throw switch.

There is a silent tuning control on the first detector which controls the sensitivity of the receiver and which also minimizes interstation noise. The triode portion of the '85 second detector is the first audio stage. The audio volume control, as well as the monitor volume control, both control the output from the second detector tube. The second audio stage is a '76 resistance coupled amplifier which has the phone jack in its plate circuit. This stage is transformer coupled to the audio output stage, which consists of a pair of 42s operating as triodes in push-pull as class AB amplifiers. The speaker field acts as the second filter choke and the speaker is designed for high fidelity reproduction.

The intermediate frequency is 432 KC in order to minimize ship interference on the long waves.

Either a doublet or a grounded antenna can be used with this receiver and a power supply switch is provided to cut off the B supply when transmitting. A monitor switch permits transmissions to be monitored. This switch cuts off the plate voltage in the radio-frequency portion of the receiver and allows the balance of the receiver to operate as a diode monitor and audio amplifier.

The designers of the PR-12 are to be congratulated on the excellent circuit isolation and shielding.

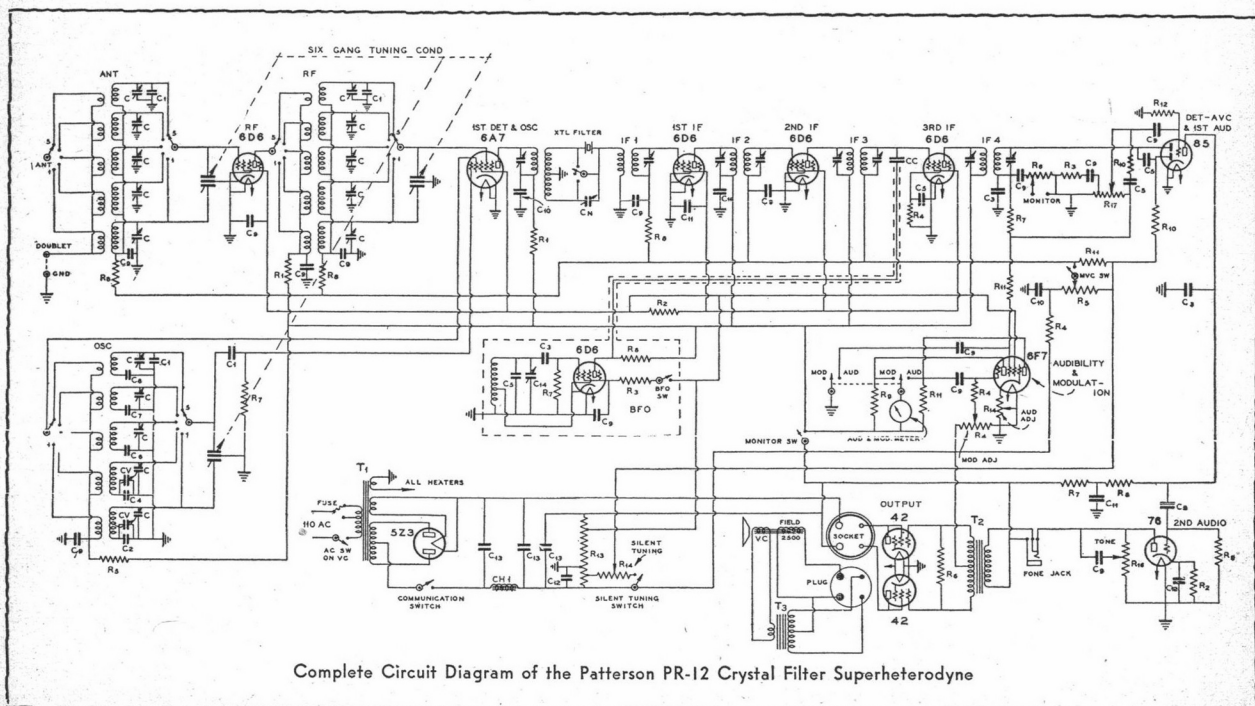

Complete Circuit Diagram of the Patterson PR-12 Crystal Filter Superheterodyne

Aural Monitoring

(Continued from page 15)

humless. The filter consists of 150 henry choke and a dual 8 mfd. condenser, the output being 275 volts DC under load. The power transformer has an electrostatic shield between primary and secondary windings to avoid undesired pick-up from the AC power lines. Both transformer and choke are completely shielded. A pilot light bezel is illuminated to indicate the monitor is in operation. A potentiometer is used as a gain control, with the AC switch mounted on it. This control is in the diode return circuit. The grid of the triode receives its audio input from the drop across this resistance. The "pot" and the series grid resistor are bypassed to ground. This by-passing is important because it precludes any RF being introduced to the grid of the audio.

Any RF at the grid would seriously impair the quality of reproduction. The output circuit receives its audio through the plate resistor capacity method. This method removes the possibility of the output being "hot", and also easily lends itself to external resistance coupling.

A tapped coil secondary, shorting type switch and variable condenser are used in the tuned diode circuit. A primary coil is placed in inductive relation to the secondary. One side of the coil is grounded, the other is connected to the A post on the binding post strip. A medium length piece of wire is used on the "A" post for pick-up from the actual transmission over the air from the nearby transmitting antenna. A ground lead to the "G" post is optional. The variable tuning condenser is insulated above ground. The shorting type band selector switch has five positions.

A heater-cathode 84 type tube is used as a full wave rectifier for plate supply to the triode of the 85.

Those positions not being used are automatically shorted, eliminating "dead ends". The positions are:

- 1— 5-meter band.
- 2— 10-meter band.
- 3— 20-meter band.
- 4— 75-meter band.
- 5— 160-meter band.

Any intermediary frequencies can be monitored because the range is continuous from below 5 meters to about 200 meters.

The monitor components are completely contained in a steel cabinet 8½-in. high by 6-in. wide by 10-in. deep, offering thorough shielding of the unit. The panel and chassis are copper-plated. The cabinet, panel and top of chassis are finished in black ripple.

With proper precautions taken in the construction of a radio-telephony monitor, the output should be free from inherent distortion, possess linear demodulating properties, be absolutely humless and capable of sufficient volume for monitoring purposes.

New Plate Coupling To Audio

(Continued from page 26)

4. Fixed bias is obtained by the usual self-bias method.
5. Higher gain per tube in addition to the transformer step-up is made possible.
6. More power output is obtained.
7. The circuit is very simple and is easily understood and applied.
8. Circuit constants are not critical.
9. Tubes may be worked at their normal recommended operating conditions.
10. The field of audio transformers is greatly enlarged.

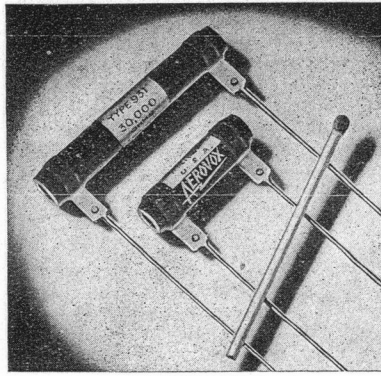

SMALLER yet BETTER!

Genuine wire-wound vitreous-enamel 10-watt and 5-watt Pyrohm Jr. Resistors . . . smaller than a match! Aerovox engineered . . . for tight places . . . without sacrificing performance or life.



Quality resistance wire. Refractory tube support. Wire ends brazed to lugs. Pigtails soldered to terminal bands. Thoroughly sealed against moisture. 5, 10, 15, 20 watts. Inexpensive.



If adjustable resistance is needed, Aerovox offers complete line of adjustable resistors . . . 10 to 200 watts . . . all resistance values . . . built to stand the gaff.

Compare prices—and quality. Aerovox list prices are usually lower than competitive makes. Aerovox quality is unchallenged.

You get more for less money when you insist on condensers and resistors in the yellow and black cartons.

FREE DATA: New 1935 catalog on request. Sample copy of monthly Research Worker, too. Ask your local dealer to show you the Aerovox line.

AEROVOX

CORPORATION

84 Washington St.

Brooklyn, N. Y.



1935 SPRING & SUMMER ALLIED CATALOG

You will find complete answers to all of your Short Wave Transmitting and Receiving needs in this new Catalog, devoted 100% to Radio. Prices are LOWER than ever before—it will pay you to consult this book before you do your radio buying. Every leading standard Short Wave line is listed—outstanding new gear is fully described. Use the ALLIED Catalog and take advantage of our personal service. Let us help you with quotations for building any type of circuit—let our competent engineers and Amateurs in on your problems. We can always serve you better at ALLIED.



ALLIED RADIO

ALLIED RADIO CORP.

833 W. Jackson Blvd., Chicago, Dept. J.
Send me your FREE 1935 Spring and Summer Catalog.

Name _____
Address _____

QUALITY

at a Price You Can Afford to Pay!

FRANKLIN Transformers

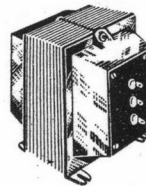

Very conservative ratings on Transformers and Chokes for every Amateur Station.

"MOST SOCK PER DOLLAR"

Write for Catalogs

FRANKLIN TRANSFORMER MFG. CO.
607-609 22 Ave. N.E., Minneapolis, Minn.

TWO OUTSTANDING PEAK DEVELOPMENTS

PEAK

LINEAR DETECTION RADIO TELEPHONY MONITOR
This newest PEAK product brings to your ears the audio component of the carrier being monitored. Audio distortion in any form, carrier and audio hum, can be immediately heard. It's a necessity for proper operation of any radiotelephone station on all bands from 5-200 M. Not for C.W. Now on sale at Jobbers everywhere. List price \$33.00 with usual discounts to Hams. Ask your dealer or send to us for literature.

110-125 V.
50-60 Cycles

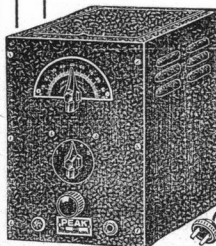

Ask Your Dealer About Peak M-2 and P-11 Today!

REGENERATIVE PRESELECTOR — PREAMPLIFIER

Predates and Modernizes Your Present Receiver
Hams everywhere are talking about this great development. Gives you brilliant reception with your present receiver. Here's what P-11 gives you: 1. Tremendous Increase in Signal Strength. 2. Increase in Sensitivity. 3. Rejection of Image. 4. Increased Selectivity. 5. Reduction of Noise to Signal Ratio. List Price, less tubes, \$33.00. 40% discount to Hams. Your cost \$19.80

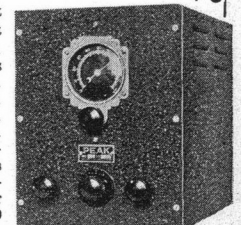

PEAK

Eastern Radio Specialty Co. Manufacturers of PEAK Products
1845 Broadway, Dept. R. New York, N.Y.

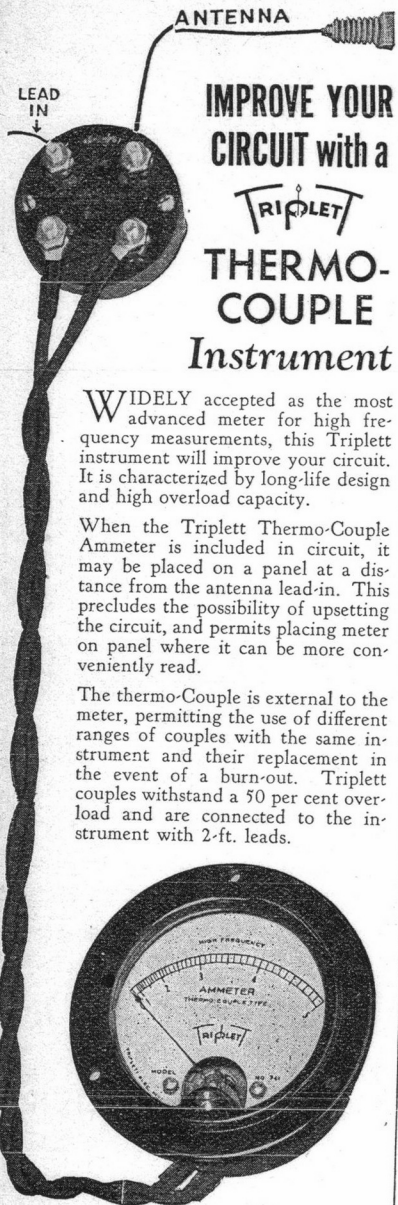

ANTENNA

LEAD IN

**IMPROVE YOUR
CIRCUIT with a
TRIPLET
THERMO-
COUPLE
Instrument**

WIDELY accepted as the most advanced meter for high frequency measurements, this Triplet instrument will improve your circuit. It is characterized by long-life design and high overload capacity.

When the Triplet Thermo-Couple Ammeter is included in circuit, it may be placed on a panel at a distance from the antenna lead-in. This precludes the possibility of upsetting the circuit, and permits placing meter on panel where it can be more conveniently read.

The thermo-Couple is external to the meter, permitting the use of different ranges of couples with the same instrument and their replacement in the event of a burn-out. Triplet couples withstand a 50 per cent overload and are connected to the instrument with 2-ft. leads.

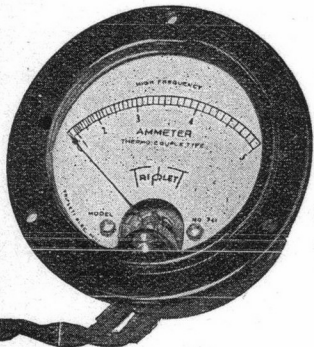

No. 341—3-in. Model

This is one of the many Triplet instruments furnished in 2-in., 3-in., 4-in., 5-in., 6-in. and 8-in. sizes . . . and all popular ranges and types.

See the Triplet Thermo-Couple Ammeter
AT YOUR JOBBER'S!

LIST PRICE
\$10.00

Triplet Electrical Instrument Co.
144 Main Street Bluffton, Ohio

Mail Coupon Today

Triplet Electrical Instrument Co.
144 Main Street, Bluffton, Ohio.
Please send me your literature on Triplet Instruments.

Name _____
Street Address _____
City _____ State _____

AT LAST



Any Battery Radio Set, whether 2 volt, 6 volt or 32 volt can now be made All Electric, with a Carter Genemotor — the modern "B" Eliminator.

Greater Power—No Current Fluctuation—Minimum Operating Cost—Electrically and Mechanically Guaranteed.

There is a Carter Genemotor for Sound Systems, Two-Way Police Radios, Transmitters, etc.

Write for our latest catalog—it's free.
CARTER MOTOR CO.
365 W. Superior St. Chicago

HEADPHONES for the EXPERT

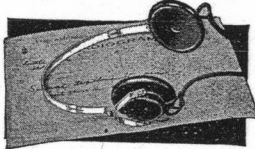

The
Famous
**SPECIAL
TRIMM**

FEATHERWEIGHT

Precision built, like a fine instrument, sturdy, ultra-sensitive, yet the entire weight on your head is but **FOUR OUNCES!**

TRIMM
RADIO MFG. CO.
1528 ARMITAGE AVE. CHICAGO, U. S. A.

**BUD LO-LOSS
TRANSMITTING
SOCKET**

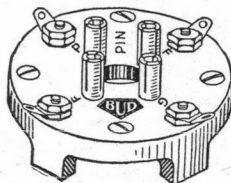

Flush Mounting for
50-Watt Tubes.

Most efficient transmitting socket on the market. Positive contacts. Base of socket is made of Isotex. All metal parts are heavy brass and nickel plated. For Low Loss Transmitting socket this is what you want.

No. 226.....Price \$1.50



Your Favorite Jobber Stocks
BUD RADIO Parts
Write for New 1935 Catalog

List prices shown in this advertisement are subject to 40% discount when purchase is made from an authorized BUD jobber. If your jobber cannot supply BUD parts, send your order direct to us together with your jobber's name and we will make shipment direct.

BUD RADIO, INC.
1937 E. 55th St. Cleveland, Ohio

\$1 brings you the next four issues
of "RADIO"—Subscribe NOW.

WARD LEONARD



**MIDGET
REMOTE CONTROL
RELAYS**

Send for your free copy of circular 507B

WARD LEONARD ELECTRIC CO.
41 South Street, Mount Vernon, N. Y.
Please send me a free copy of your latest bulletin on Midget Remote Control Relays.

Name _____
Street _____
City and State _____
Call Signal _____

**CATHODE-RAY
Testing and Analysis**

A new booklet now on the press, written by Kendall Clough. Has over 50 illustrations. Tells how to test and service amplifiers, transmitters, and filter systems with Cathode-Ray Equipment. You must have a copy to be up to date. Ask your jobber, or write today.

Send 25c for your copy

The CLOUGH-BRENGLE CO.
1136 W. Austin Ave. Chicago, U. S. A.



*Specializes in
Quality*

- BINDING POSTS
- TIP JACKS •
- MALE PLUGS •
- FEMALE PLUGS
- LOW-LOSS SOCKETS
- A-C SWITCHES
- TAP SWITCHES •
- TERMINAL STRIPS
- SHORT WAVE SWITCHES

Write for Latest Bulletin

HUGH H. EBY Inc.
2066 Hunting Park Ave.
PHILADELPHIA, PENNA.



Big News

From T. R. McElroy
World's Fastest Telegrapher

An Open Letter To the Radiomen of the U. S. . . .

Instead of a regular advertising layout, I am using this space to send a little note to radiomen, amateur and professional, something along the lines of a "report of progress" on this new Mac-Key business of mine. The enthusiastic support I've had from you fellows convinces me that the business is a matter of interest to you all as well as to me. Regardless of the merits of my key, the venture would be a flop without the support of you all, so you are entitled to know what is going on. Here's the dope:

I announced my Mac-Key early in December and up to late in March, as I write this "report," I find I have sold close to 400 Mac-Keys. On the basis of this showing, I'm taking a plunge and investing in volume production patterns, dies, jigs, etc., which will enable me to turn out my keys at a lowered cost—provided I continue to receive the support of the fellows in the game. The kind of letters I've had from the fellows who've bought my keys, and the conversations I've had with amateurs and professionals during a trip I've just completed in the northeast, convince me I'm safe in figuring on this cooperation.

So then, here goes: The Mac-Key will now list at \$13.25 f.o.b. Boston and I will continue the customary introductory discount of 40%, making my key net to you fellows at \$7.95. My guarantee remains as always, that the Mac-Key is the only semi-automatic key made with which it is possible to send perfect Continental code with its multiple dash figures and letters. That you can send better with a Mac-Key than with any other key made, or your money refunded after 5 days' trial.

Come on, now! Dig up the dough somewhere and grab off one of these keys and listen to code that you've probably dreamed of but never expected to be able to send. Buy the thing from your favorite distributor. On the level, fellows, those guys have helped me tremendously and they deserve support from both you and myself. Their profit isn't great and, as a matter of fact, their support, along with yours, has brought this price as low as I'm taking the chance on putting it.

To name just a few of them: Spokane Radio, Spokane, Wash.; Offenbach Electric, San Francisco; Henry Radio Shop, Butler, Mo.; Uncle Dave, Albany; M. & H. Sporting Goods, Philadelphia; Gross Radio, New York; Ed Wilcox, Chicago; Bill Shuler, New Orleans; Radio Shack, Boston, and last but not the least my old pal Bill Halligan, the demon "Hallierafter" in Chicago, who makes the Skyrider superhets. I dunno much about the receiving set part of radio, but I know that I can flip those dials on this Hallierafter and grab off code from all over the world. And a lotta fellows who know me, know that a great deal of the time I can hardly see the dials—it's that easy to tune.

Even if you can't dig up the dough for the key, won't you steal a minute to drop me a note and let me know what the prospects are for the time you will be able to get one? Kindest regards and again thanks for the support you've given me.

MAC.

T. R. McElroy

23 Bayside Street

Upham's Corner P. O. Boston, Mass.

The New RADIO RECEPTOR Moving Coil Microphone

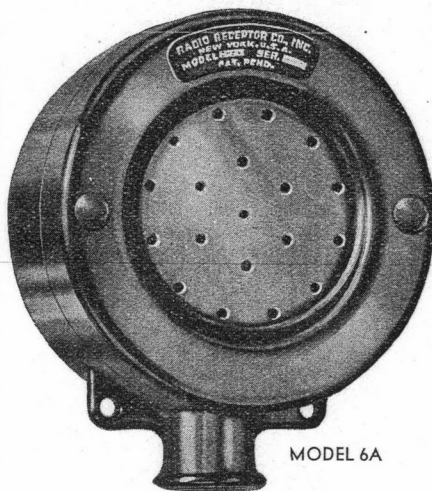

MODEL 6A

Sets New Standards
in High Fidelity
Transmission

Three Types Are Now
Available

MODEL 6 C—Special type for amateur and PA applications. Sensitivity—(—59DB) normal speech at 3 ft. Output impedance 30 ohms. Net weight 2 1/4 lbs. Diameter 3 3/8". Depth 2 1/4". Furnished in a chrome finish. Net price to hams \$23.10. Response uniform 40 to 7500 cycles.

MODEL 6 B—Specially adapted for public address and remote broadcast pickup. Has an extremely high output and may be substituted for a carbon microphone without the use of a preamplifier in most cases. Sensitivity—(—49DB) normal speech at 3 feet. Output impedance 30 ohms. Net weight 2 3/4 lbs. Diameter 3 3/8". Depth 2 1/4". Furnished in a chrome finish. Net price to PA engineers \$35.00. Response uniform 40 to 7500.

MODEL 6 A—Specifically designed for wide range high fidelity transmission in broadcasting and recording work. Sensitivity—(—55DB) normal speech at 3 feet. Output impedance 30 ohms. Net weight 2 lbs. Diameter 3 3/8". Depth 2 1/4". Furnished in a chrome or old bronze finish. Net price to broadcast stations, recording studios and universities \$70.00. Response uniform 30 to 12,000 cycles.

Critical users of the Radio Receptor Dynamic Microphone consider it the ideal transmitter because:

- Free of hiss or internally generated noise
- The pickup area is uniform over an angle of 135°
- Extremely rugged, weatherproof and shock-proof (used by the Martin Johnson African expedition in the filming of Baboona)
- Because of its high sensitivity only a main amplifier of plus 80 or 90 DB is necessary to operate at the normal plus 30 level.
- Unaffected by extreme changes in temperature, moisture, wind or dust.
- Has no cavity resonance.
- Low impedance output permits use of long line (even 1000 feet) to amplifier without danger of external pickup or loss of high frequencies.
- High permeability cobalt magnet does away with exciting current from external sources.
- Wide range natural response for voice and music.

DISTRIBUTED BY

PACIFIC RADIO EXCHANGE, INC., Los Angeles, Calif.

RADIO SUPPLY CO., Los Angeles, Calif.

RADIO TELEVISION SUPPLY CO., Los Angeles, Calif.

SAN FRANCISCO RADIO EXCHANGE, San Francisco, Calif.

SEATTLE RADIO SUPPLY, Seattle, Wash.

CHICAGO RADIO APPARATUS, Chicago, Ill.

WALTER ASHE, St. Louis, Mo.

WHOLESALE RADIO SERVICE, New York, N. Y.

Prompt Overnight Deliveries on All Models F.O.B. New York

RADIO RECEPTOR CO.

110 SEVENTH AVENUE

Established 1922

NEW YORK, N. Y.



new! KELLOGG TRANSCIVER HANDSET

A better all-around Transceiver Handset! Highly efficient single-button Kellogg microphone, super-sensitive Kellogg receiver. Easy to hold. Fits the face. ● Microphone has greater sensitivity and "fatter" response curve than the usual "mike" of this type. Precision built, as are all Kellogg products. Gold plated diaphragm. Especially processed carbon.

● Receiver is the product of 35 years experience building telephone apparatus. Bi-polar magnet of cobalt steel. Cadmium plated diaphragm. Small, compact, easy on the ear. ● Simply and ruggedly constructed and light weight. Cast aluminum triangular handle. Baked black enamel finish. Has 6-foot, 4-conductor, 18-strand tinsel cord of telephone quality. ● You will be proud to own this unit. Better yet, it's not expensive. Code No. 38-A, 70 ohm receiver, list price \$10.00. Code No. 38-B, 2000 ohm receiver, list price \$11.

KELLOGG SWITCHBOARD & SUPPLY CO.
1070 W. Adams St. CHICAGO, ILLINOIS

ASTATIC

CRYSTAL MICROPHONES AND PICKUPS

Guaranteed instruments, known for their quality, dependability and ruggedness. Extensively used in both Professional and Amateur fields. Send for your literature today!

ASTATIC MICROPHONE LABORATORY INC., YOUNGSTOWN, OHIO

Quicker than a...
Short circuit!

LITTELFUSES

Instrument Littlefuses, for meters, 1/200 amp. up.
Hi-Volt Littlefuses for transmitters, etc. 1000, 5000 and 10,000 volt ranges, 1/16 amp. up.
Neon Voltage Fuses & Indicators (Tattletails) 100, 250, 500, 1,000 & 2,000 volt ratings.
Aircraft Fuses Auto Fuses, Fuse Mountings, etc.
Get new Catalog No. 6
LITTLEFUSE LABS., 4503 Ravenswood Ave., Chicago, Ill.

New

**ELECTRAD
VOLUME CONTROL**

It Banishes Noise

NEVER before was such uncanny quietness made possible in a volume control. It required a radically new engineering principle and individual testing at the factory to assure its amazingly smooth, quiet operation, which actually improves with use.

Current is evenly distributed over the flat outer rim of a rigid Bakelite ring, upon which gently glides a special alloy floating contact shoe.

Molded Bakelite case, when mounted, extends only 1/2 inch back-panel. New-type power switch (approved by underwriters) may be instantly attached or removed by a single screw. Long, easy-to-cut aluminum shaft. All standard replacement values.



Resistance element baked on flat outer rim of Bakelite ring.

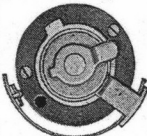

Floating contact shoe glides over resistance element in straight path.

Mail Coupon for FREE Descriptive Folder, and 1935 General Catalog of Resistors for Every Purpose.

175 Varick St., New York, N.Y.

ELECTRAD

MAIL COUPON FOR 1935 CATALOG

Name.....
Address.....
.....PR-4

CANNON-BALL HEADSETS

Made by America's oldest manufacturer of headsets

Heavy bar magnets, double pole, aluminum cases, D. C. resistances of 2000, 3000 and 5000 ohms.

Sturdy construction, sensitive and faithful in reproduction.

Sold everywhere in America

C. F. CANNON CO.
SPRINGWATER, N. Y.

"Politics"

(Continued from page 9)

certain that there is something wrong with them.

At any rate the foregoing incident so affected one man in the audience that he declared, "Well, we'll have an amateur organization in which there shall be nothing BUT politics—a club for the sole purpose of discussing policies that have to do with the rights and frequency bands of the amateurs—a club the sole aim of which shall be to invoke political support for the restoration of amateur rights and channels."

This declaration of intention came, as may have been conjectured, from a member of the San Jose club, that old organization with a long and consistent record of militant action in the defense of amateur rights. The reader may have surmised that the member in question was myself. I hasten to remove such stigma from the new Cairo Club of San Jose. The formation of the club was well under way before I had even heard of it. It was only later that I was called to a meeting at which the purposes and program were outlined and set down on paper. Elsewhere in this issue we print the purpose of the new organization. We believe it will inspire other groups of amateurs to take similar action. There should be a Cairo Club in every town and hamlet where there are enlightened amateurs.

At the next international convention there will be a direct drive by commercial interests for all of the amateurs' most useful bands. The notion that the present treaty safeguards the amateurs' present bands is utterly fallacious; there is not a thing in it that gives the amateurs any hold on the bands called "amateur." No nation has agreed that amateurs shall have the occupancy of these bands; the treaty merely half-heartedly says that when a nation does permit amateur stations such stations shall be located in the bands now called "amateur." Nor does the treaty prevent commercial stations from locating in these bands. The international bureau at Berne has registered scores of commercial stations now operating in these bands that do not even appear on the Berne records. I have before me, compiled recently by an

amateur in Switzerland, a list of 189 commercial stations either logged by himself in the amateur bands or that are registered in those bands with the Berne Bureau. And this observer is only ONE man and a man living where he can hear only a part of the invaders of the amateur bands. There are 20 commercials registered in our 40 meter band alone and many more heard that are not registered. Of the 20 registered 8 of them are broadcast stations—some of them in countries that are signatories of the present treaty. There will be a determined effort to exclude the amateurs from this our most valuable band as well as all other amateur bands useful to the commercial corporations.

The Congress of the United States is the ONLY body on earth that can preserve the right of the United States amateurs to their share of the air. The Congress is the ONLY body that can secure for the United States amateurs more frequencies. And the appeal of United States amateurs—by groups and individually—direct to members of the Congress is the ONLY means by which the necessities of the United States amateurs may be made known to the Congress.

CLAIR FOSTER, W6HM.



No use doing a nose-dive under the service bench—or digging into a bunch of old cigarette tins for that umphump ohm resistor . . .

Get this new CENTRALAB HANDY RESISTOR RACK that's FREE with an assortment of 40 CENTRALAB RESISTORS.

You'll like the way you can instantly "spot" just the resistor you're looking for . . . or tell just what resistance values are missing.

FREE!

CENTRALAB HANDY FIXED RESISTOR RACK

15x9 1/2 inches . . . sturdy steel and includes an R.M.A. Color Chart in FULL COLORS.

NEW! Centralab Volume Control Guide

The new CENTRALAB VOLUME CONTROL GUIDE is now out . . . better than ever before . . . much new dope . . . Ask your jobber for a copy.

Centralab

(Division of)
GLOBE UNION MFG. CO.
MILWAUKEE

MAIL COUPON NOW!

CENTRALAB
900 E. Keefe Ave. Milwaukee, Wis.

Please send me information about your special deal which includes a FREE HANDY FIXED RESISTOR RACK.

NAME.....
ADDRESS.....
CITY..... STATE.....
MY JOBBER IS..... (Radio)



MILLIONS IN USE

- Two Year Guarantee
- Low Power Factor
- Long Life
- Self Healing
- Efficient & Compact
- Patented & Patents Pending

The superior quality and performance of millions of Duco Condensers are recognized all over the world.

NOW GUARANTEED FOR 2 YEARS

Manufactured by

DUMONT ELECTRIC COMPANY, Inc.

453-5 Broome St., New York, N. Y.
Write for free Catalogs, Sales and Jobber Territory

Variable Carrier Linear

(Continued from page 8)

fer in that the plate current rises with modulation until the plate input is slightly over 1 KW during a period of 100 per cent modulation, or, in other words, during a period of maximum audio signal applied to the microphone.

The plate efficiency varies somewhat with modulation, but only between 50 per cent and 70 per cent as limits, instead of between about 30 per cent to 60 per cent, which is more typical of the conventional linear amplifier when amplifying a CONSTANT CARRIER modulated wave.

In conventional class B linear amplifiers amplifying a CONSTANT CARRIER modulated wave, a pair of 150Ts or HK354s are capable of a carrier output of about 150 watts, with an additional output of about 75 watts of side-band power during periods of 100 per cent modulation.

When amplifying a VARIABLE CARRIER modulated wave, these same two 150Ts or HK354s give an equivalent carrier output of 500 watts, plus 250 watts of additional side-band power during heavy modulation, AND THE 150Ts OR HK354s RUN MUCH COOLER.

In other words, the use of VARIABLE CARRIER MODULATION allows an ordinary linear amplifier to give from two to four times the normal expected power output from an ordinary linear RF amplifier.

The only thing to remember is that the high voltage power supply must have fair voltage regulation, because the plate input drawn by the linear varies from about 150 watts with no audio signal, to about 1000 watts during heavy modulation, a ratio of about 6.5 to one. This is not as wide a variation as in a class B audio stage but it is still too much when condenser input is used.

It begins to look as if few amateur stations of the future will ever have use for any modulator larger than a pair of class B 46s, because linear amplifiers are now much more economical than the use of high level modulation. As a matter of fact, with VOICE OPERATED CARRIER CONTROL it is desirable to modulate with as low power as possible, and then use one or possibly two class B linear stages to bring the power output up to any point desired. May "RADIO" will bring you the whole story.

A Linear Rectifier

(Continued from page 19)

audio bear note with the crystal oscillator. The audio note from the receiver loudspeaker or headset can be put into the microphone. Next month a description will be given of a simple 400 cycle, pure sine wave oscillator. The audio oscillator used with this equipment, or with a cathode-ray tube oscillograph, should be of pure sine wave output so the distortion measured is only in the transmitter, not in the test equipment.

BIRNBACH Superior INSULATORS

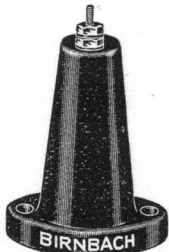

4 1/2" HIGH
All other Stand-off models and sizes down to 3/8" high.

BIRNBACH RADIO CO., Inc.
145 HUDSON STREET NEW YORK CITY



McMURDO-SILVER

Do You Know That

There must be a reason for this condition—and there is—performance plus. Ask anybody you work why he reports you R9 and we'll bet that once out of every three times a 5C in his shack will be the answer.

You know the 5C's predecessor, the 5B, was chosen and used exclusively by W9USA all through last year's Fair and that alone tells the story of performance plus. The roster of it and the newer 5C's users includes governments, commercial companies, engineering universities and amateurs. But read what W6DYQ says of it, for a typical example.

And get this one—the 5C is the only amateur receiver whose maker thinks it good enough to dare offer it to you on a ten day trial basis—hook 'er up, operate it for ten days, and if you're not absolutely satisfied, just return it undamaged and you'll get your money back. It's just so good we get less than half of one per cent back for refund!

Why the 5C is better

is told by its features—send a stamp and you'll get the story promptly. But outstanding are: no loss of signal strength on single signal. Automatic volume con-

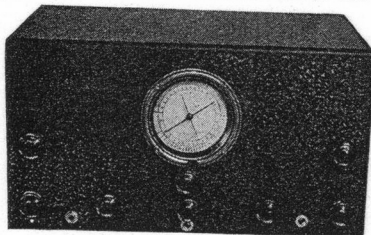

THE 5-C

Built in a single unit with self-contained power supply, with separate speaker and hot and cold running water—in a word, with everything the ideal receiver should have. Yet it's priced, ready to go, with speaker and eight Raytheon tubes, at \$74.70 net to you, or \$83.70 net with specially selected and aligned single signal crystal filter.

Order one today on 10-day trial and find out what a real receiver can do for your schedules

McMURDO SILVER INC. 3362-D N. Paulina St. CHICAGO, ILL.

We still believe that more 5C professional superheterodynes have gone into amateur stations in the last six months than have any other commercial superhets—at least, so our sales tell us.

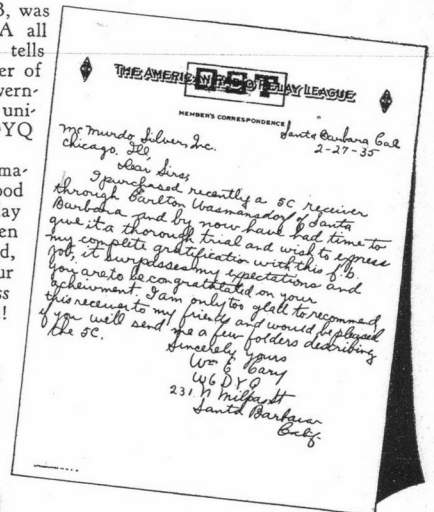

trol that really is automatic volume control—or cut it out by a switch. Band spread and full coverage (1500 to 23,000 kc. on one dial by pulling out the single tuning knob. One high gain real t.r.f. stage that cuts out images and boosts weak signals. Very low inherent noise. Absolute day in and day out dependability and performance such as the commercials demand.

HIGH GRADE, LOW PRICED RELAY RACKS CARTER SPECIALTIES RACKS

All-Steel, Baked Enamel Finish—Interchangeable Black Crinkle Panels

Send 25% Deposit if COD Shipment Desired. Racks and panels shipped Knock-Down.

RADIO ZACK

SUPPLY COMPANY

EQUAL PANEL ASSORTMENTS AT NO EXTRA COST	
4 3/4"x19, each. . \$0.45	17 1/2"x19, each. . \$1.80
8 3/4"x19, each. . . 90	7 x16, each. . . 75
13 1/4"x19, each. . 1.35	14 x16, each. . 1.50
RUSTLESS STEEL CHASSIS TO FIT:	
10x17x1 3/4, each	75c
8x14x1 1/4, each	60c

Everything for the Amateur and Service Man

1470 Market St.

SAN FRANCISCO

HARRISON RADIO CO. OFFERS YOU GENUINE *Western Electric*

211-D \$4.90

Fifty Watt Transmitting Tubes
BRAND NEW! * FULLY GUARANTEED!

Standard Fifty Watter base. Standard characteristics (Interchangeable with type 211 and 211-A). Has new long life filament! Rated RF output as an amplifier—100 WATTS!

Every tube is in its original sealed Western Electric carton! The WESTERN ELECTRIC name is your guarantee of highest quality! We guarantee REAL VALUE and COMPLETE SATISFACTION!

Regular selling price—\$17.50. Harrison's SPECIAL PRICE—only \$4.90! Your money cheerfully refunded if you do not agree with us that this is the GREATEST VALUE ever offered to the Amateur! Every tube is UNCONDITIONALLY GUARANTEED FOR THIRTY DAYS! (Broken glass or burnt-out filament the ONLY exception!)

*** PLEASE NOTE!**
These brand new, fully guaranteed, genuine Western Electric 211-D tubes are not to be confused with the type 211-E which is designed for AF work!
These TUBES are FB for RF!

W.E. 211-D CHARACTERISTICS

FILAMENT VOLTS	10
FILAMENT CURRENT	3 AMPERES
NORMAL PLATE VOLTAGE	750 to 1000
AVERAGE PLATE CURRENT	65 MA
PLATE IMPEDANCE	3500 OHMS
NORMAL RF POWER OUTPUT:	
AS AN OSCILLATOR	50 WATTS
AS AN AMPLIFIER	100 WATTS

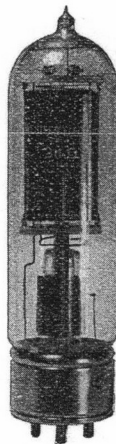

HARRISON RADIO CO. 142 Liberty St., Dept. P65
NEW YORK CITY



Osockme, Japan.
February 23, 1935.

Statistical Editor of
"RADIO", Hon. Ed.:

Inquiring amateur has writ me for inamation on what Japanese amateurs do for living, how they make use of their time and what are customs in my country and why. Scratchi think that Hon. Editor will find great interest in one-year log of my life, which tell with extreme details everything Scratchi do for entire 365 days in year. Scratchi do not work for a living. He do not have to. He are too smart. With aid of sliding rule and large assortment of books and measuring instruments, Scratchi and millions of other countrymen here in Japan have solved intricate problem of living most happy without ever finding time for doing any work. For other amateurs who also prefer to live on fat of land like Scratchi do, I give you here my secret formula for everlasting happy living.

Scratchi find from calendar that there are 365 days in each year, are there not? Answer is yes. Scratchi sleep 8 hours each day. That take away 122 days from year. That leave 243 days left in year. Scratchi also work ham station 8 hours each day. That take away another 121 days from each year. That leave only 121 days left in year. Now come Sunday once every 7 days and that take away another 52 days from year, which leave only 69 days left. Right? Civilized people work only half day Saturday, which knock off another 26 days from year, leaving only 43 days left. Scratchi take off hour and half each day for lunch and dinner combined and put together. That take away 28 days more. nd take away 28 days from 43 days and there are only 15 days left.

It are an old Japanese costume to take off 2 weeks for vacation each year, and Scratchi follow suit, which take away 14 more days and leave only one day left in each year. What do you think Scratchi do on that one day which are left? That, Hon. Ed., are my birthday, on which I go out and celebrate by making whoopee and throwing rocks at the mayor. I have therefore make account of every day of all 365 days which are in year, and I make defiance to any amateur to prove Scratchi are wrong. If you should receive rebuttal letters to this statement from Scratchi, you are at liberty, Hon. Ed., to make post notice of prize which Scratchi will donate. Such prize are to be three large boxes of assorted high frequency oscillations. I must go back to work now, and make same good use of my time as I make every day in year, as henceforth and fifth set forth above.

Yours etetera,
Hashafisti Scratchi.

The Newest Wrinkle In Modulation Tubes

(Continued from page 23)

In Fig. 5 is shown the same choke with the connections arranged so that the DC is bucking in a manner similar to the circuit of Fig. 2.

Always remember that THE IMPEDANCE RATIO OF ANY TWO WINDINGS ON THE SAME CORE IS EQUAL TO THE SQUARE OF THE TURNS RATIO. Conversely, it is seen that THE TURNS RATIO OF ANY TWO WINDINGS ON THE SAME CORE IS EQUAL TO THE SQUARE ROOT OF THE IMPEDANCE RATIOS.

**RUN YOUR A. C. RADIO
by DIRECT CURRENT**

DC LIGHT SOCKET

Operates AC Radios, Amplifiers, transmitters, etc., from 6, 32 or 110 DC. See your Distributor or write KATO ENGINEERING CO. Mankato, Minn., U. S. A. Light plants \$99.00

AC Generators \$16.00

ADDS THOUSANDS of Miles to Your Receiving Range



Sargent Regenerative
Pre-Selector

More than doubles the number of foreign stations you can hear! Greatly increases selectivity! REGENERATION is the answer. The most sensitive type of input for a radio set that engineers have been able to devise in 35 years of continuous radio development.

No guesswork about it, you can HEAR IT yourself. There is a cut-over switch on the Pre-Selector so you can instantly compare signal, noise level and interference with and without the Pre-Selector. Once you make the comparison, you are sold. Once you try it you will never operate a set without it.

Band switch changes coils. Individual coils with separate antenna couplings for each band. Special tap switch shorts out unused coils. Works with any super, matches appearance of Sargent 8-34. Net Price, including tube, \$14.75.

8-34 COIL KIT, STANDARD MODEL

Same parts as used in 8-34 Receiver. Individual oscillator and detector coils for each band, short-circuiting type tap switch, padders, full circuit blueprint, instructions and coil shield included.

A TRIED AND PROVEN coil unit that YOU KNOW will give satisfaction. IF Transformers not included. Tunes 15-550 meters. Net Price, \$7.50.

8-34 COIL KIT, MARINE MODEL

As above, with Marine waveband coils, padders and extra coil shield. Tunes 15-1500 meters. Net Price, \$12.00.

REGENERATIVE PRE-SELECTOR COIL KIT

Same parts as used in our own Pre-Selector. Tunes 15-550 meters, individual coils each band, special short-circuiting type tap switch, blueprint, instructions, cut-over switch included. Net Price, \$3.90.

It's a Treat to Listen in on This One!



\$54.50
Complete

SARGENT 8-34 RECEIVER

Everything you want in a real Short Wave Receiver. Hundreds sold to enthusiastic amateurs and fans is our best testimonial. Tunes 15-550 meters, band spread, beat oscillator, self-contained power supply. Price includes tubes and dynamic speaker unit. Nothing else to buy. 5-Day Money Back Trial. Order Yours Today.

MARINE MODEL 8-34

As above, with another waveband added. Continuous tuning, 15 to 1500 meters. An ideal shipboard receiver. D.C. prices on request.

AMATEUR SPECIAL KIT

Our most popular kit! One stage tuned RF, regenerative detector, 2A5 audio. Illuminated dials, band spread, plug-in coils included covering 15-200 meters. Excellent short wave broadcast and C.W. receiver. Complete kit includes chassis, crackle finished panel, all parts to build the set. Write for full data.

ROUND-THE-WORLD-3

Not sold in kit form. Completely built-up ready to operate. Has power rack, tubes and coils to cover 15 to 200 meters. Uses regenerative 57 detector, 56 audio, 80 reftier. Price complete, less headphones. Ideal beginner's short wave set.

E. M. SARGENT CO. 212-R 9th St. Oakland, Calif.

A. T. CRYSTALS

With New Low Loss

Power Type Mounting

Priced as low as \$4.95

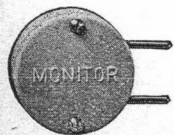

See Your Dealer
Bulletin on request

Monitor Crystals
2802 West Avenue 32
Los Angeles, Calif.

LAMPKIN LABORATORIES

announces the new location of their main office and shop at Bradenton, Fla., where the manufacture of specialized, precision equipment of original design will be continued. All technical inquiries, orders, etc., should be addressed to the main office. Please note the following new features: a sales office at the old address, 146 West McMillan Street, Cincinnati, Ohio; prepaid shipment on all orders accompanied by the full purchase price, in lieu of cash discount.

BRADENTON, FLA., U.S.A. ASK FOR DATA ON THE MFM. OR THE MIXER MONITOR

\$1 brings you the next four issues of "RADIO"—Subscribe NOW.

NEW JOHNSON "Hi-Q" TRANSMITTING INDUCTORS

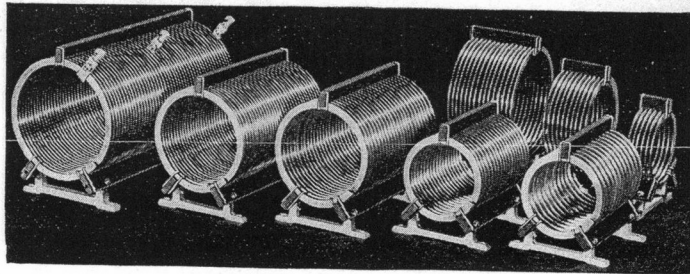

Here's the answer to the inductor problem in your 1935 transmitter . . . Scientifically designed, accurately-constructed transmitting inductors, ready to connect in your circuit! They enable you to attain peak efficiency and provide new convenience in adjustment of tuning and loading. And they're ideal for the new **Band-Switching circuits!** Bulletin 350 gives circuit data and complete details—write for it today. (Transmitting Condensers to match are described in Bulletin 200).

- **PEAK EFFICIENCY.** Carefully-chosen shape-factors, generous conductor size and minimum dielectric in coil field insure peak efficiency. Models for high-C or low-C, single-ended or push-pull operation in all amateur bands.

- **EXTREME FLEXIBILITY.** Easily, quickly adjusted to the **exact** value required by means of special low-resistance clips. Ideal for the new Band-Switching circuits!

- **EXCEPTIONALLY RUGGED and COMPACT.** Edgewise copper construction combines high mechanical strength with minimum inductor size.

Available from Authorized Johnson Distributors

E. F. JOHNSON COMPANY
Manufacturers of Radio Transmitting Equipment
WASECA, MINNESOTA, U. S. A.

FORMS CLOSE ON THE 10th OF MONTH

RATES 10¢ PER WORD PAYABLE IN ADVANCE

**CLASSIFIED
RADIOADS**

QSLs, 75¢ per 100. 2 colors. W9DGH, 1816 5th Ave. North, Minneapolis, Minnesota.

The "222" Crystal Filter Superheterodyne with R.F. Stage, described in this issue is for sale by the designer and builder, Frank C. Jones. No further need is had for it. Will sell, complete with 465 Bliley Crystal, all tubes and coils for 20, 40 and 80 meter bands for \$49.00. Also have for sale similar "222" receiver but without crystal filter, as described in March "RADIO." Has r.f. stage and coils for 20, 40 and 80 meter bands. Complete with new tubes. Sell for \$39.00. Also for sale one 5-meter, 7 tube superheterodyne, described in this issue. Complete with new tubes and speaker, ready to operate, \$59. Frank C. Jones, 2037 Durant Ave., Berkeley, Calif.

CRYSTALLINE CRACKLE PAINT—A new single-coat aldry finish. Jobber's name and folder free. **CAMPBELL RADIO SPECIALTIES**, Ann Arbor, Michigan.

Crystals 80-160M—x cut \$1.50 postpaid—Approx. freq. Bliley Holders \$1.00. W6TT, 1020 Oak Street, Oakland, California.

RADIO ENGINEERING

RCA Institutes offers an intensive course of high standard embracing all phases of Radio. Practical training with modern equipment at New York and Chicago schools. Also specialized courses and Home Study Courses under "No obligation" plan. Illustrated catalog on request.



RCA INSTITUTES, INC., Dept. RA-34
75 Varick St., N. Y. 1154 Merchandise Mart, Chicago
Recognized Standard in Radio Instruction Since 1909

CROWE "MICROMASTER"

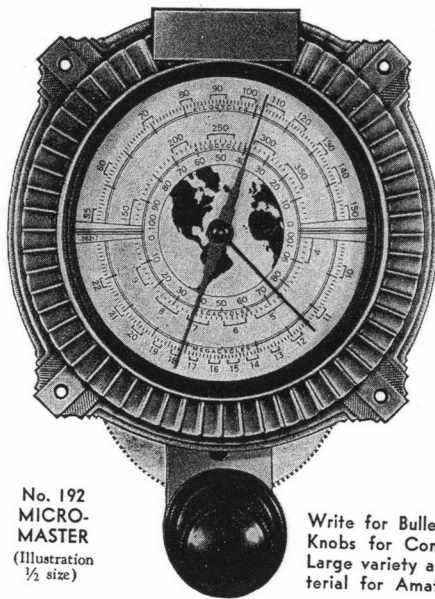

No. 192
MICRO-
MASTER
(Illustration
1/2 size)

**Precision Recording Control
For All Short Wave Sets**

Has auxiliary pointer affording exact repeat indication of wave length. Stations however closely crowded may be accurately logged.

Slow speed ratio 45 to 1; fast speed 9 to 1 in 360 degrees. Secondary pointer travels faster than double pointer.

Can be supplied with other scales or with special calibrations made to order. Specify scale wanted. Made in several sizes: 3 1/2", 4" and 2 3/4" diameter of scale.

New escutcheons are featured for the various sizes and have a synthetic transparent non-inflammable Croglas convex crystal eliminating breakage. The crystal inserted in escutcheon seals air leakage or coupling behind baffle.

Write for Bulletin No. 60, covering Dials, Plates and Knobs for Constant Impedance and Gain Controls. Large variety and latest forms. Complete line of material for Amateurs, Experimenters and Set Builders.

Export orders receive special attention, Cable Address—CROWNAME CHICAGO.

CROWE NAME PLATE & MFG. CO.

1755 GRACE STREET

Established 35 Years

CHICAGO, ILL., U. S. A.

Pacific Coast Representative—W. BERT KNIGHT, INC.

Radio Dealers and Jobbers who desire to advertise in these columns are invited to write for rates.

RADIO BUYERS' GUIDE

A Monthly Listing of Reliable Radio Dealers and Jobbers who solicit the patronage of our readers. Buy from your nearest Dealer or Distributor. He is dependable and reliable.

CHICAGO, ILLINOIS

Chicago Radio Apparatus Company, Inc.

415 South Dearborn Street
Harrison 2276

Dependable Radio Equipment
Established 1921

Bulletins on request.
Everything for the amateur.
Get our very low prices.

CHICAGO, ILLINOIS

MID-WEST RADIO MART

520 South State Street
CHICAGO

Write for Special Catalog—Free

SCHENECTADY, NEW YORK

ATLANTIC RADIO SUPPLY CO.

712 Broadway

Complete Equipment Stocked for
Service men—Amateurs—Experimenters

Let us quote you

OAKLAND, CALIFORNIA

RADIO SUPPLY CO.

2085 BROADWAY.

Hammarlund, Yaxley, Carter, National, Johnson, IRC, Cardwell, Miller, Morrill, Flechteim, Triplett, Haigis Transceivers
W6GFY

ST. PAUL, MINNESOTA

LEW BONN COMPANY

2484 University Avenue

Rex L. Munger, W9LIP, Sales Engineer

Radio Wholesaler

Complete Stock

BUFFALO, N. Y.

DYMAC RADIO

216 E. Genesee St.

CL 2080

Complete Stock Amateur Parts
STANDARD DISCOUNTS

—W8AWK—

LOS ANGELES, CALIFORNIA

RADIO SUPPLY CO.

912 SO. BROADWAY

The Amateurs' HEADQUARTERS of the WEST

All Nationally Advertised Parts for Receiving and Transmitting carried in stock at all times.

9 Licensed Amateurs on Our Staff

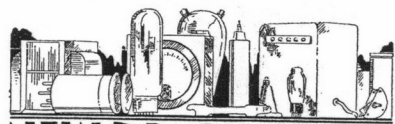

NEW PRODUCTS

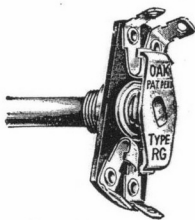

Oak R and S Type Switches

OAK Manufacturing Company, 711 West Lake Street, Chicago, Illinois, is introducing additions to its line of rotor switches in the form of compact, single and double pole, two-position units. The new switches fill requirements for tone control applications, phonograph switches, and wave band switches for midget radios.

Retaining the desirable characteristics of the Oak Junior types, the new RG type, available with grounded common poles, measures only 1/2-in. deep from bushing shoulder by 1 1/2-in. long by 1 1/8-in. wide. The R type, of the same dimensions, has the common poles insulated from ground.

The single grounded pole S type is of the same construction and size as the RG type, except for its length which is only 1 1/8-in.

Three-position units are now being developed. Standard bushings for both types are 3/8-in. by 1/4-in. thread length. Standard shafts are 1/2-in. diameter by length specified.

The superiority of these new switches will be readily recognized. As a result of undergoing the same rigid tests as the larger units in the Oak line, they provide the same dependability that has won wide acceptance for Oak Switches.

The makers invite your requests for samples and quotations, without obligation, of course.

New Bliley Crystal Catalog



THE Bliley Electric Company, Erie, Pa., has recently published an eight-page bulletin describing its complete line of Quartz Crystals and holders for transmitters, single signal filters and standard frequency bars. The catalog is divided into two sections:

general communication frequency crystals and amateur frequency crystals. Copies of this bulletin, G-6, may be secured by writing to the Bliley Electric Company, 202 Union Station Bldg., Erie, Pa.



Low-Loss Acorn Socket By Alden Mfg. Co.

A SPECIALLY designed socket for use with the new line of Acorn tubes. In keeping with the necessity of holding losses to an extreme minimum, use has been made of that new material, Na-Ald Vietron, which has so low a loss factor as to be below that of fused quartz which has up to now been considered the ultimate in a low loss material.

Experimenters and amateurs will be glad to know that the Alden Products Company of Brockton, Mass., have available this new No. 4955V Acorn Tube socket at a list price of \$1.50.

The base is made flat for ease in holding down the heater by-pass condenser plates as suggested by the manufacturer. A post is provided which makes it impossible to incorrectly place the tube in the socket.

The socket comes completely assembled with special phosphor bronze clips ready to use.

CHICAGO, ILLINOIS

Chicago Radio Apparatus Company, Inc.

415 South Dearborn Street
Harrison 2276

Dependable Radio Equipment

Established 1921

Bulletins on request.
Everything for the amateur.
Get our very low prices.

SAN FRANCISCO, CALIFORNIA



1452 Market Street.

"The House of a Million Radio Parts"

Hammarlund and National sets and parts.

Sylvania Amateur Transmitting Tubes

Collins Transmitters.

Arcturus Receiving Tubes.

Trim Phones, all types.

Johnson Antenna Feeders, Insulators,
Transposition Blocks.

FRESNO, CALIFORNIA

PORTS MANUFACTURING CO.

3265 E. Belmont Ave. Radio W6AWV
National FB7-SW3 and Parts; Hammarlund,
Cardwell, Bliley Crystals; Johnson Insulators.
Distributors RCA-DeForest Transmitting Tubes
Established 1914 Send for Wholesale Catalog

BUTLER, MISSOURI

HENRY RADIO SHOP

Complete stock of Collins, Patterson, National, Hammarlund, Silver, RME9D, Super-Skyrider, Peake, Mac-Keys, Eimac, Sylvania, Taylor, Thordarson, Cornell-Dubilier, Cardwell, Dwyer, Triplett, Weston, Turner, Astatic, Trimm, Johnson, Bliley, and others at lowest wholesale prices. Your used apparatus accepted in trade, too. Write for any information.

Robt. Henry, W9ARA, Owner, 211-15 N. Main St.

OAKLAND, CALIFORNIA

ELECTRIC SUPPLY CO.

12th and Fallon Sts.—"Down by the Lake"

Our New Catalog contains valuable information for Dealers, Servicemen and Amateurs. FREE.

Amperex Transmitting and
Special Purpose Tubes

Raytheon 4-Pillar Tubes Factory Sealed Cartons

DISCOUNT 40% on most all lines

W6AZG	{ Located in }	W6IDB
W6DTM	{ our store }	W6KGE

CHICAGO, ILLINOIS

Newark Electric Company

226 W. Madison St.
Chicago

All Kinds of Equipment for
Service Men - Amateurs - Experimenters
Write for free catalog

**ONLY CROSLEY DEALERS
CAN PROFIT by**

This much more in a
SHELVADOR

**EXCLUSIVELY IN
CROSLEY
ELECTRIC REFRIGERATORS**



**3
TYPES
9
MODELS**



As poetry, not so hot. But as a selling *idea* there's a world of meaning and of profit in the simple rhyme—"This much more in a Shelvador." To this let us add—"and twice as easy to find."

There is no argument so convincing as a *record*. And the record shows that the Shelvador feature has been most productive single sales factor in recent electric refrigeration history. During 1934 the Crosley Shelvador Electric Refrigerator showed the greatest sales growth in the entire field. And 1935 will far exceed 1934. That's not guess-work. It's a certainty, already partially established. During January Shelvador sales were 360% ahead of the same month in 1934. Gains of 200% and more are common. Some dealers report a 1000% increase.

The Shelvador—with its greatly increased usable space—has lifted the Crosley Electric Refrigerator out of competition. Crosley quality—established and proved by hundreds of thousands of satisfied users—has received national recognition. Crosley value is even more aptly illustrated in these models than ever before.

As for you—if you are not now selling the Crosley Line—let the success of others be your guide. The more you look into this matter, the more you'll find that you cannot afford NOT to handle Crosley.

* * *

All 1935 models have the Shelvador feature, flat bar shelves, no-stop defrosting control, new-designed chromium-plated hardware, porcelain interior. Shelvador and Tri-Shelvador models have in addition: Automatic interior light, ventilated front. All Tri-Shelvador models add to these features: Shelvatray, Shelvabasket, Storabin and self-closing ice-tray chamber door.

Prices in Florida, Texas, Rocky Mountain states and west, slightly higher.

THE CROSLEY RADIO CORPORATION
CINCINNATI

POWEL CROSLEY, Jr., President.

(Pioneer Manufacturers of Radio Receiving Sets)

Home of WLW—the world's most powerful broadcasting station.

2 TABLE SHELVADORS

TABLE SHELVADOR

FR-20—2 cu. ft. NET Capacity. Semi-hermetic Rotary Compressor. Dimensions: 38" high, 23 3/4" wide, 25" deep. (Shown at left) **\$79.50**

TABLE SHELVADOR

FR-30—3.1 cu. ft. NET Capacity. Rotary Compressor. Same dimensions as FR-20 **\$94.50**

4 SHELVADOR MODELS

SHELVADOR MODEL FA-40

4.09 cu. ft. NET Capacity. 8.6 sq. ft. shelf area. 2 ice trays—42 cubes. Dimensions: 52 3/4" high, 23 3/4" wide, 26 3/4" deep. **\$112.50**

SHELVADOR MODEL FA-60

6 cu. ft. NET Capacity. 13.5 sq. ft. shelf area. 3 ice trays—63 cubes—one double-depth tray. Dimensions: 56 3/4" high, 30 3/4" wide, 26 3/4" deep. **\$149.50**

SHELVADOR MODEL FA-50

5 cu. ft. NET Capacity. 11.3 sq. ft. shelf area. 2 ice trays—42 cubes—one double-depth tray. Dimensions: 56 3/4" high, 25 3/4" wide, 24 3/4" deep. (Shown at left) **\$129.50**

SHELVADOR MODEL FA-70

7.08 cu. ft. NET Capacity. 14.9 sq. ft. shelf area. 4 ice trays—84 cubes—one double-depth tray. Dimensions: 57 3/4" high, 32 3/4" wide, 25 3/4" deep. **\$169.50**

3 TRI-SHELVADOR MODELS

Models FA-50, FA-60, FA-70, and all Tri-Shelvador Models also available with porcelain exterior at slight extra cost.

TRI-SHELVADOR MODEL F-55

5.51 cu. ft. NET Capacity. 11.6 sq. ft. shelf area. 3 ice trays—63 cubes—one double-depth tray. Dimensions: 57 3/4" high, 29" wide, 24 3/4" deep. **\$164.50**

TRI-SHELVADOR MODEL F-43

4.3 cu. ft. NET Capacity. 9.15 sq. ft. shelf area. 2 ice trays—42 cubes—one double-depth tray. Dimensions: 56-9/16" high, 23 3/4" wide, 23 3/2" deep. **\$139.50**

TRI-SHELVADOR MODEL F-70

7.08 cu. ft. NET Capacity. 14.9 sq. ft. shelf area. 4 ice trays—84 cubes—one double-depth tray. Dimensions: 58 3/4" high, 32 3/4" wide, 25 3/4" deep. (Shown at left) **\$189.50**

ALL PRICES INCLUDE DELIVERY..INSTALLATION..ONE YEAR FREE SERVICE



Controlled Carrier Modulation Now a Practical Reality With the UTC VARIATOR

Using the Variator Phone Men Are Switching Over to Controlled Carrier Modulation Because This System Makes Possible:

- ★ GREATER DX—INCREASED BLANKET COVERAGE
- ★ GREATER RF POWER WITH SMALLER TUBES—INCREASED TUBE LIFE
- ★ LESS INTERFERENCE
- ★ MUCH LOWER POWER CONSUMPTION FROM AC LINE
- ★ HIGHER FIDELITY
- ★ INCREASED EFFICIENCY FROM CLASS B LINEAR STAGES

The Essential Variator Unit Required for Controlled Carrier Modulation Is Now Available in Six Types to Take Care of Transmitters From 25 to 800 Watts Output.

CV VARIATORS FOR CONTROLLED CARRIER CLASS C

	List Price	Net to Hams
CV-1 25 to 50 watts maximum input controlled class C	\$ 7.50	\$ 4.50
CV-2 50 to 100 watts maximum input controlled class C	10.00	6.00
CV-3 100 to 170 watts maximum input controlled class C	15.00	9.00
CV-4 170 to 300 watts maximum input controlled class C	20.00	12.00
CV-5 300 to 500 watts maximum input controlled class C	25.00	15.00
CV-6 500 to 800 watts maximum input controlled class C	33.00	19.80

AV AUTOTRANSFORMERS FOR CV VARIATORS—115/170 VOLTS AC

	List	Net
AV-1 for use with CV-1	\$5.00	\$3.00
AV-2 for use with CV-2	6.00	4.20
AV-3 for use with CV-3	7.00	5.40
AV-4 for use with CV-4	9.00	7.20
AV-5 for use with CV-5	12.00	9.00
AV-6 for use with CV-6	15.00	9.00

CV VARIATORS are suitable for obtaining controlled carrier on any transmitter using high level plate modulation. For existing equipment the corresponding AV autotransformer must be used with the CV VARIATOR.

BV VARIATORS are designed to maintain constant or over-compensated plate voltage to class B tubes permitting low distortion with increased power output.
BV VARIATORS for class B audio (autotransformer self contained).

	List	Net
BV-1 for 46's, 59's, or four 6A6's, 53's, 79's	\$ 7.50	\$4.50
BV-2 for four 46's, or 210's, 801's, 800's	11.00	6.60
BV-3 for 211's, 242A's 830B's, 203A's	16.00	9.60

A Universal Choke for Every Purpose

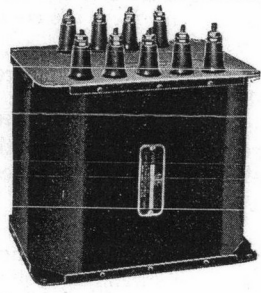

What This Universal Modulation Choke Will Do:

Broadcast and phone men who want an output audio unit that will match all possible tube impedance combinations to the RF Stage cannot afford to be without the new UTC Universal Modulation Output Chokes.

TYPE		LIST PRICE	NET TO HAMS
HUC-20	Will handle 20 watts audio power. Can be used with class B 46's, 59's, 53, 6A6, 79, etc., or class A 2A3's, class A prime 42's, 45's, etc.	\$7.00	\$4.20
HUC-50	Will handle 50 watts audio power. Suitable for use with class B 210's, 801's, 830's, 841's, push pull parallel 46's or 59's, push pull parallel 45's A prime, push pull parallel 2A3's.	\$12.50	\$7.50
HUC-100	Will handle 100 watts audio power. Suitable for use with class B 800's, 211E's, A prime 284's, 845's, etc.	\$20.00	\$12.00
HUC-200	Will handle 200 watts audio power. Suitable for use with class B 203's, 830B's, HK-354's, single EIMAC 150T, push pull parallel 845's, prime, etc.	\$32.50	\$19.50
HUC-500	Will handle 500 watts audio power. Suitable for use with class B 204's, HK354's, EIMAC 150T's, A prime 212D's, A prime 849's, etc.	\$80.00	\$48.00

It is tapped so that it can be used as an autotransformer coupler from Class B to Class C stages; various impedance taps are available so that each choke will readily accommodate push pull Class A-Prime or Class B Modulators, single ended Class A Modulator with the DC adding, or single ended Class A Modulator with the DC bucking.

The chokes are huskily constructed and air gaps are arranged to take care of the maximum DC currents.

Complete circuit matching data furnished with each unit.

UNITED TRANSFORMER CORP.

264-266 CANAL STREET

Export Division, 15 Laight St., New York, N. Y.

NEW YORK, N. Y.

Exclusive UTC distributors carrying a complete stock of UTC products.

- | | | |
|---|---|--|
| Goldhamer's, Inc. 610 Huron Road, Cleveland, Ohio | Hall's 35 So. Cameron, Harrisburgh, Penna. | |
| Wholesale Radio Service Co., Inc. 100 Sixth Ave., New York, N. Y. | Cameradio Company 603 Grant Street, Pittsburgh, Pa. | |
| Wholesale Radio Service Co., Inc. 219 Central Ave., Newark, N. J. | W. H. Edwards & Co. 32 Bway, Providence, R. I. | |
| Wholesale Radio Service, Inc. 430 W. Peachtree St. N. W., Atlanta, Ga. | SEATTLE, WASH.—Seattle Radio Supply, Inc. 2319 Second Ave. | |
| Sun Radio 227 Fulton Street, New York, N. Y. | Portland Radio Supply Co. 1300 W. Burnside, Portland, Ore. | |
| Gross Radio, Inc. 51 Vesey Street, New York City | Spokane Radio Co., Inc. 611 First Ave., Spokane, Wash. | |
| Leeds 45 Vesey Street, New York City | San Francisco Radio Exchange 1284 Market St., San Francisco, Calif. | |
| William Gram 1444 Sheridan St., Lansing, Mich. | SOUTHERN CALIFORNIA | |
| Mohawk Electric Co. 1335 State St., Schenectady, N. Y. | Pacific Radio Exchange Inc. 729 S. Main St., Los Angeles | |
| Walter Ashe 1100 Pine St., St. Louis, Mo. | Radio Supply Co. 912-14 S. Broadway, Los Angeles | |
| Radio Shack 46 Brattle St., Boston, Mass. | Coast Electric Co. 744 G. St., San Diego | |
| Nutter & Cross 900 Milk St., Boston, Mass. | Prest & Dean Radio Co. 400 American Avenue, Long Beach | |
| Radio Service Lab. of N. H. 1008 Elm St., Manchester, New Hampshire | Radio Television Supply Co. 1701 S. Grand Ave., Los Angeles, Calif. | |
| Hatry & Young 203 Ann St., Hartford, Conn. | Radio Specialties Co. 1816 West 8th St., Los Angeles, Calif. | |