

**OHM'S LAW**

$$E = I \times R$$

$$R = \frac{E}{I}$$

$$I = \frac{E}{R}$$

**CONDENSERS IN SERIES**

$$C_{TOTAL} = \frac{C_1 \times C_2}{C_1 + C_2}$$

**RESISTANCES IN PARALLEL**

$$R_{TOTAL} = \frac{R_1 \times R_2}{R_1 + R_2}$$

25c [ 30c in Canada ]

JUNE, 1935

\$3.00 PER YEAR BY SUBSCRIPTION

# RADIO

ESTABLISHED 1917

## SHORT-WAVE AND EXPERIMENTAL

- IN THIS ISSUE -

A "Very Low Wave" Receiver

All-Band Regenerative Exciter-Amplifier

How to Build High-Voltage Condensers

Antenna Field-Strength Measuring Set

An Improved 5-Meter Superheterodyne

Part II—Class B Audio Considerations

**BOTTOM VIEWS OF SOCKETS**

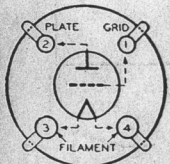

4-PRONG SOCKET  
0-201-A, 45, 210, 30, 31, ETC.

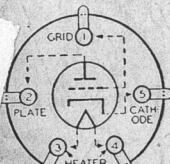

5-PRONG SOCKET  
56-46-47-76-27-37

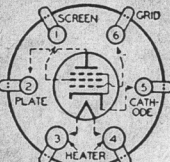

6-PRONG SOCKET  
2A5-41-42-43

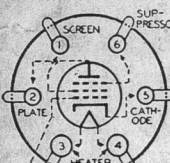

6-PRONG SOCKET  
57-58-606-606-77-78

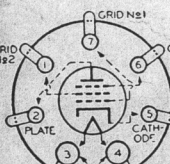

7-PRONG SOCKET 59

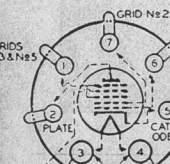

7-PRONG SOCKET  
2A7-6A7



120 Watt C.W. Transmitter using three Type '10 Tubes in the final amplifier. All-band operation is secured by means of the Jones Regenerative Exciter. The low cost of the tubes and power supply for this transmitter will be welcomed by the amateur who wants more power output from a small transmitter.

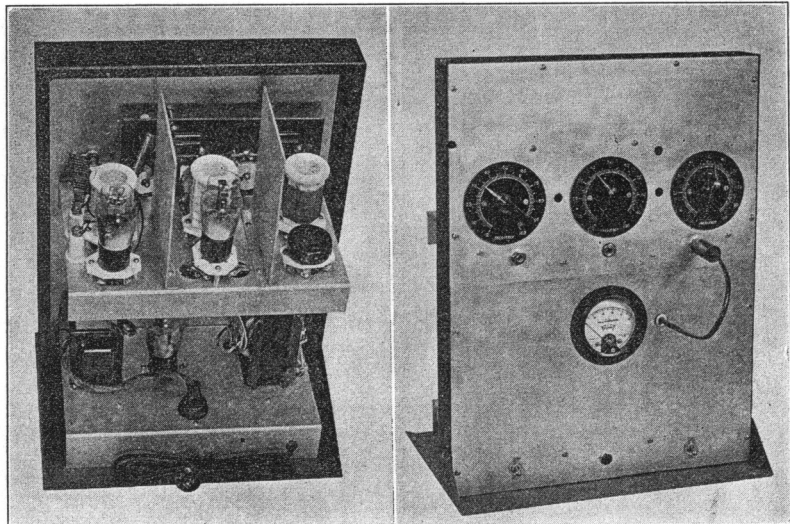

**FEATURE ARTICLES BY ...**

FRANK C. JONES  
J. N. A. HAWKINS

- FRANK LESTER  
- RALPH O. GORDON

- COL. C. FOSTER  
- I. A. MITCHELL

Type TMV-135-A. Amateurs' net prices, f.o.b. factory, V-cut Crystal and Holder, \$12.00; Holder alone, \$2.50



*Announcing the*

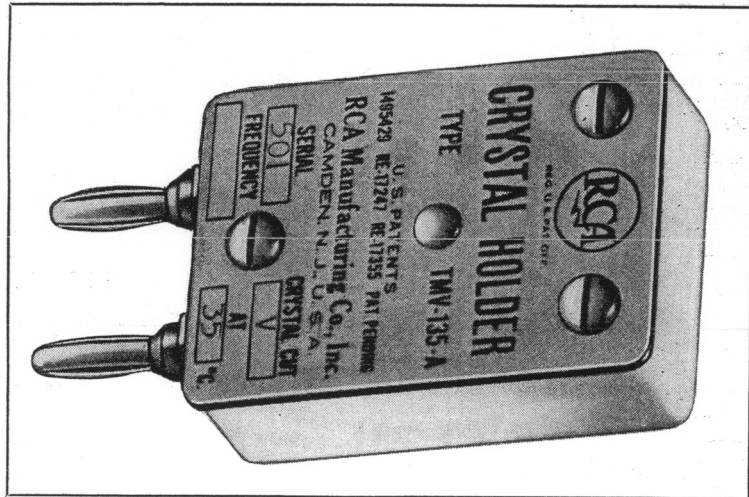

## NEW V-CUT CRYSTAL

to give a new degree of frequency stability  
to amateur stations

RCA is proud to introduce the new V-cut Crystal for amateur use. This entirely new cut, developed by RCA, has a temperature coefficient of only 2 cycles or less per million per degree centigrade at normal temperatures. V-cut Crystals therefore bring a new high degree of frequency stability to amateur stations. In addition to the remarkably low temperature coefficient, the new crystals possess the other outstanding advantages of high activity, ruggedness, freedom from spurious oscillations and frequency jumps, and a calibrated accuracy of 0.005%.

In order to make the fullest use of the V-cut Crystal's advantages, a special air-gap pressure-type ceramic crystal holder has been developed. This holder may be had separately, if desired, as it may be used to great advantage with other crystals.

RCA V-cut Crystals for the 3.5-to-4.0-megacycle band are now available, within plus or minus 5 kilocycles of the desired frequency, or choice from stock. See your authorized sales outlet for your requirements. A descriptive folder is available on request to:



**AMATEUR RADIO SECTION**

RCA VICTOR DIVISION

RCA Manufacturing Company, Inc.

Camden

New Jersey

# HAMMARLUND

## CONDENSERS

Are Made in  
**18 TYPES**  
 for Every  
 Radio Purpose

WHATEVER your condenser need may be—for transmitting, receiving, trimming, balancing, padding, antenna tuning, etc.—Hammarlund makes it in the required capacity rating.

*Eighteen different types for every radio purpose—priced at 30 cents to \$18.00 list.*

And as to QUALITY—practically every amateur and professional operator, and every radio manufacturer throughout the world, since 1910, has respected Hammarlund prestige.

But *talk* is not *proof*. Put Hammarlund Condensers to the severest tests and let *experience* demonstrate how greatly they improve the performance of any circuit.

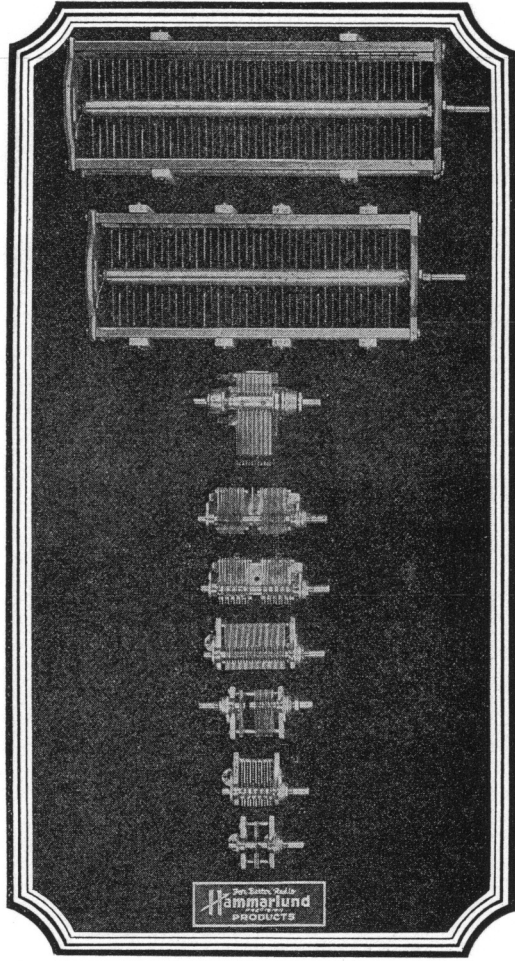

### Mail Coupon for Details

Canadian Office:  
 41 West Ave. North,  
 Hamilton, Ontario

Mail Coupon for  
 Catalog



HAMMARLUND MANUFACTURING CO.  
 424-438 W. 33rd St., New York.

Check here for Condenser information.  
 Check here for FREE General Catalog.  
 Check here *and attach* 10c for new 32-page Hammarlund Short-Wave Manual, illustrating and describing most popular S-W circuits of past year, with schematic and picture diagrams and parts lists.

Name.....  
 Address.....  
 .....PR-6

# Professional Equipment at Amateur Prices!

Below are but 5 of the hundreds of Ham items that may be found in our NEW, FREE 100% Amateur Catalog! 48 pages chock full of diagrams, general operating hints, questions and answers on X'mitting and receiving troubles, plus all the latest s.w. and all wave sets and kits, antenna equipment, tubes and accessories. The coupon (preferably attached to your call card) will bring your FREE copy at once.



## Lafayette PB-46 30 WATT XMTR With Speech Amplifier Modulator

For the Ham who cannot afford the expensive, high powered job, Lafayette offers the PB-46—a completely self-contained job, including power supply which will operate wherever 110 V. 50-60 cycle current is available.

Circuit employed is the popular "Les-tet" Oscillator Buffer and Doubler with a pair of 46's in parallel operated as a Class "C" Amplifier.

The speech amplifier modulator will modulate

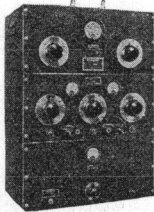

the Xmtr 100% with 60 watts in-put. Its output is 30 watts absolutely undistorted with an overall gain of 112 Db. Frequency response is flat within 1.5 Db between 60-17,000 cycles.

An antenna coupler unit permits accurate tuning of the antenna feeders. The neutral position of the series-parallel switch permits the tuning of the final amplifier for minimum plate current with the antenna load disconnected.

|   |         |
|---|---------|
| P-46—XMTR—only, less tubes                  | \$49.50 |
| P-46—XMTR—in kit form—less tubes            | 44.50   |
| B-46—Speech Amplifier Modulator less tubes  | 39.50   |
| B-46—Speech Amplifier Modulator in kit form | 34.50   |
| A-46—Antenna Coupler                        | 19.95   |

## Lafayette 100 WATT XMTR

This modern 100 watt C.W. and 30-40 watt Phone Transmitter will amaze you . . . Not only is its initial cost low, but for its rated output it is the most economical transmitter ever offered the amateur.

It incorporates all the latest features such as the following: 1. Suppressor-grid modulation that provides 100% modulation with a minimum of modulating equipment. 2. Crystal frequency control—the new "Les-tet" harmonic oscillator, which with a single 2B6 tube provides a stable crystal oscillator and is a very efficient doubler or a Neutralizer buffer stage, having more than sufficient output to excite the 100 watt Class B Pentode Amplifier. 3. An Universal antenna matching unit that permits successful operation on practically any type antenna.

Everything is self-contained. Just connect a key, a crystal microphone and antenna. Plug into any 110 V. 60 cycle outlet and operate! Complete control through use of meters permanently connected in circuit.

Comes complete with 1 set of coils (choice of 80, 40, or 20 M. bands) **\$195**  
Kit of tubes: 2-RK20's, 2-2B6's, 1-57, 5-83's 35.59

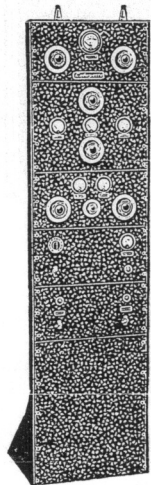

## "Les-tet" BEGINNERS XMITTER KIT

A NEW low power x'mtr that is simple yet efficient. Uses only one 56 and one 59 tube both of which are easily obtained and low in price. A 160 M. x'tal may be used to operate on 40 M. with an output of 2-3 watts or on 80 M. with an output of 5-7 watts.



Kit includes all parts including 1 set of coils (specify whether 160, 80, 40 or 20 meters) less tubes, crystal and cabinet. No. PXY22073. **\$9.95**  
Kit of tubes, 1-56, 1-59 1.75

## Lafayette "PRO-9" AMATEUR SUPERHET

Here is the last word in modern amateur kits! It incorporates a factory assembled coil switching unit so that only a few simple connections are needed to wire this unit into the completed receiver. Features 1 R.F. stage

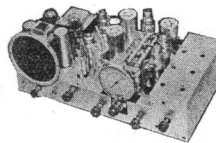

Beat Frequency oscillator for C.W.; AVC or manual control; Demountable Power-Speaker unit, etc. No. PXY22069 complete kit of parts including speaker but less tubes and cabinet, **\$36.75**. If wanted completely wired, \$7.50 Extra.

## WHOLESALE SPONSORS

### VARIATOR CONTROLLED CARRIER MODULATION

We are the largest distributors of UTC Transformers in the East. Variators for controlled carrier modulation in stock for immediate 12 hour shipment!

## Lafayette 5 METER TRANSCEIVERS

Get acquainted with the Lafayette "19" and "30"! You can consistently get loud speaker reception up to 20-25 miles with the "19." Uses a type 19 tube in the p.p. oscillator and has a power output of approx. 2 watts (about 10 times the power of units in this class). The Lafayette "30" is similar but uses a type 30 as the oscillator for X'mitting and a type 33 pentode as modulator, providing clearly understood signals. Entirely self-contained. Wgt. 26 lbs., complete with batteries.

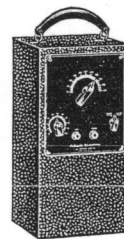

Lafayette "19"—Transceiver, less tubes and batteries ..... **\$17.95**  
Lafayette "19"—Transceiver in kit form less tubes and batteries ..... **\$14.95**  
Lafayette "30"—Transceiver, less tubes and batteries ..... **\$ 9.95**

# WHOLESALE RADIO SERVICE CO.

Main Office and Warehouse  
100 SIXTH AVENUE • NEW YORK, N.Y.

BRONX, N.Y. 542 E. Fordham Rd.

ATLANTA, GA. 430 W. Peachtree St. N.W.

NEWARK, N.J. 319 Central Ave.

WHOLESALE RADIO SERVICE CO.  
100 Sixth Ave., Dept. P-65  
New York, New York.

Send me your new FREE exclusive HAM catalog of 48 pages.

Send me the order described in attached letter.

Name \_\_\_\_\_

Address \_\_\_\_\_

City \_\_\_\_\_ State \_\_\_\_\_

BRANCH OFFICES:  
 New York City,  
 253 W. 128th St.  
 Tel. MOument 2-2812  
 Boston,  
 J. H. Condon,  
 6 Marlboro St.  
 Chicago,  
 C. W. Nelson,  
 3618 North Bernard St.  
 Los Angeles, Calif.,  
 1455 Glenville Drive.  
 Tel. CRestview 4017

# RADIO

ESTABLISHED 1917 Reg. U. S. Pat. Off.

A NATIONAL MAGAZINE - PUBLISHED MONTHLY

Publication Offices—Pacific Building, San Francisco, California

H. W. Dickow, Publisher.

D. B. McGown, Technical Editor.  
 Clair Foster, Amateur Activity Editor.

Frank C. Jones, Engineering Editor  
 C. C. Anderson, Engineering Draftsman.

25c per copy, \$3.00 per year by subscription in the U.S. \$4.00 elsewhere. Send subscriptions to the San Francisco office. Entered as second class matter at the Post Office at San Francisco, California, under the Act of March 3rd, 1879.

Vol. 17

JUNE, 1935

No. 6

## Radiotorial Comment

# A. R. R. L. Board Recommends Educational Campaign With the Congress

● It comes to us that the board of the American Radio Relay League at its meeting in May adopted a resolution predicated on the statement, "It is the view of the board that an educational campaign with the Congress and with the executive arm of the Federal Government concerning amateur radio is now highly desirable."

Well, it has been just as highly desirable for the many years during which the ARRL officers have done all they could to discourage any such action. But we'll let that pass.

The board appointed a committee of three directors to "commence a study of the objectives outlined in paragraph 1" (the paragraph above quoted), "and of all related questions concerning plans of the ARRL for the Cairo conference, including specifically co-operation with amateurs in other countries, the need for specific legislation, and all ways and means of securing extension of amateur privileges by international agreement."

This magazine agrees thoroughly in principle with the directors if their action presages active work with Congress in behalf of all United States amateurs. "RADIO" has been urging such action for two years; individual amateurs have been urging it and practicing it for more years; the Cairo Club of San Jose has had such plans in actual operation since March 15; other Cairo Clubs are actively at work in different parts of the country. The Cairo Clubs will welcome the opportunity to be of assistance to this new committee of the ARRL.

It will be seen, however, that the wording of the resolution, obviously written by Mr. Segal, limits the functions of the committee to "studying" certain specified "objectives" and then reporting and recommending to the board. Under the wording the committee has no power to take any action whatsoever but merely to recommend. In practice a committee of directors thus limited has limited

usefulness. This committee composed of directors has no such powers as the executive committee, a majority of which are the paid employees who control it. The executive committee takes whatever action it sees fit and tells the directors about it afterwards.

Of course we do not know yet whether the committee of directors will approach their subjects from a fresh point of view and arrive at their conclusions independently or whether they will accept the premise prevailing at League headquarters that none of the surrendered frequencies of the United States amateurs can be recovered except by the consent of foreign nations. And we do not know yet whether the committee will retain the Warner-Segal-Maxim premise that United States amateurs have no rights as United States citizens but merely such "privileges" as the commercial interests and the representatives of foreign governments choose to accord. It is worthy of notice, however, that the wording of the resolution tends to impose this premise upon the thought of the committee. Note again the wording, "To study . . . all ways and means of securing extension of amateur privileges by international agreement."

This magazine subscribes to no such premise. We are certain that the Congress of the United States can determine with finality just what space in the air the citizens of the United States may use. Thus far the United States is the only government that concedes the amateurs have a real right to the use even of the bands called in the treaties "Amateur." The commercial interests of foreign nations usurp these bands as they see fit.

And this magazine does not subscribe to the premise long maintained at the ARRL headquarters that the rights of United States citizens may be classed as mere privileges accorded by the commercial interests or foreign nations.

In our opinion the committee of directors will get into deep sand on barren soil if it

tries to study "co-operation with amateurs in other countries." In the first place, any conclusions they come to here will be only through the guidance of Warner and Segal, and Warner and Segal have already lost a year in getting nowhere. In the second place, the American amateurs only hurt their own cause in their efforts to support the amateurs of foreign countries. The foreign amateurs with few exceptions are in no position to aid us, while it is certain that our efforts to help them in their fights with the representatives of their own governments arouses the antagonism of those representatives against us, and can and has limited our own effectiveness with our own government.

In theory we sympathize with foreign amateurs in certain countries but in practice we believe in keeping out of all foreign entanglements. No international association of individuals ever provided anything but bitter disappointment. An international amateur radio association—aside from its social features—is no exception.

The committee of directors will study and recommend "an educational campaign." But by the time the committee gets through studying and recommending, and the whole board gets through its discussions and, (possibly, possibly not), orders action most of Congress will already be over-educated, at the rate the Cairo Clubs are going. They are already not only "educating" but they are making specific appeals to individual members of Congress in the manner prescribed by common sense as well as by the Constitution of the United States. The Cairo Clubs are, too, already in contact with the "executive arm of the Federal Government."

So, all in all, the Cairo Clubs, having done much preliminary work and having the advice of experienced and trustworthy men in Washington, are in position to co-operate with the committee of directors of the ARRL if these gentlemen care for co-operation.

# Colonel Foster's Comment

## The A. R. R. L. Board Meeting

● The most significant circumstance of the annual meeting of the directors of the American Radio Relay League was the plain evidence that the Warner-Segal-Maxim combine is losing its long-continued domination of the board. This holds out more hope for the much exploited amateurs than anything that has ever before transpired at a meeting of the directors.

Director Bailey, who last year proposed the resolution expressing the complete confidence of the board in the integrity and competence of General Manager Warner and the hearty commendation of Warner's conduct of League affairs, evidenced this year a change of heart and scored Warner's conduct vigorously.

Director Roberts, who by all his previous utterances had shown that he was a solid Warner man, attacked without mercy both for his fixed belief that nothing could be done to regain the amateurs' lost frequencies and for the huge amounts of money he had got out of the League for a mediocre service.

Director Reid, the Canadian, vehemently lashed Warner for having made an agreement with the commercials and their adherents that the United States amateurs would ask for no more frequencies at Madrid. Reid asserted that the Canadian amateurs had got their Government to instruct the Canadian delegation to demand 200 KC more in the 40 meter band, and that Warner's action had blocked this demand of the Canadian Government.

When three formerly solid supporters of the present administration of the League come out at a board meeting and severely criticize the officers the circumstance holds profound significance. It is writ upon the wall that the long reign of dictatorship is about ended. When the more experienced members of the board show their disaffection the timid members take courage and follow suit.

Director Culver told President Maxim that Maxim's unpardonable article in QST of August, 1929, had served notice on the commercial radio people of the world that the amateurs got all that was coming to them in 1927 when they were stripped of two-thirds of their space on the air. It has always been regarded as less majeste even to criticize mildly any word or act of President Maxim. For a director, even so forthright a man as Culver, to flout Maxim before a roomful of his henchmen is something never seen before in ARRL history.

The grip of the combine never was unbreakable. It was strong only in the eyes of those hypnotized by the constant stream of propaganda issued from the League headquarters. Now that the grip is relaxing the palsied condition of the hands that exerted it is apparent.

Maxim is through. Directors themselves are canvassing the field for a strong man who will make a real president. Several outstanding amateurs of distinction who are men of achievement in the world of business are under consideration.

Warner and Segal confessed to the board their impotence in the matter of getting anything for the amateurs. Warner told the board their conviction that the amateur's chances of getting more frequencies were one in a trillion. Warner and Segal had been instructed by the board a year ago to plan for Cairo and report to the directors. All

that has been done by way of reporting in the whole year has been Warner's letters to the directors indicating his belief that it is utterly impossible for the amateurs to secure more frequencies.

Warner convinced the board of his similar belief with respect to Madrid. Segal, who makes his living serving commercial radio corporations, agreed with him. Thus is revealed the absurdity of the League's spending several thousand dollars on the expenses of this pair to go to Madrid and the \$3,000 fee paid to Segal who didn't even remain until the fighting was over. He was being paid to serve for the duration of the convention but when his \$45 a day reached the stipulated maximum he beat it.

The weakness and ineptitude of the Warner-Segal-Maxim triumvirate is made plain out of their own mouths so there is no longer any excuse even for the most gullible of amateurs to bow to their presumption of omniscience. This is what makes the recent meeting surpass all others in the significance it holds for the amateurs of America—the disintegration of a combine that has been throttling a whole board and preventing it from performing its true function, the actual direction of a corporation it was elected to direct.

The board took out of the hands of Warner and Segal the work of planning for the next convention by appointing to that end a committee of three directors instead of the two employees. The board named it the Cairo Committee. The Cairo Club of San Jose had been in intensive operation for two months before this and had perfected definite detailed plans for going after more frequencies in the only way they can be secured—by appeal to Congress. Cairo Clubs have organized and are functioning in other parts of the United States. We are glad to see the ARRL directors following in the lead of the Cairo Clubs, even to the adoption of their name for the directors' committee.

Even though forced to it by the action of hated "radicals" we are glad to see Hartford renouncing its long determination not to appeal to Congress on behalf of the huge body of citizens engaged in the operation of non-commercial radio stations. Segal now tells the board that undoubtedly a joint resolution of both branches of Congress could be secured instructing the United States delegation to Cairo to secure more frequencies for the United States amateurs or no ratifications would be forthcoming. The Pacific Division amateurs, in their convention away back in 1929, passed a resolution calling upon the ARRL directors to pursue this method. It was presented to the directors at their following meeting. The only response of the board was the retort, in a smug assumption of virtue, "The ARRL does not lobby"—as if there were something horrible in the mere thought of a citizen's exercising his right to convey his desires to his representatives in Congress. And it was Segal himself, then a director, who made this response:

We want as our legislative representatives men who are militantly alive to the rights and the needs of American amateurs—not men who the moment a suggestion is made to argue that it cannot possibly be carried out. We want men who start towards an objective without first building up in their line of march a wall of insurmountable ob-

structions. We want men who know that each obstacle in life is cleared as we come to it—not men who have the fatal habit of envisioning all future impediments, of piling them up en masse and then saying resignedly, "We cannot possibly do it." We want men without commercial leanings and without commercial connections. We want men who can attack a problem without invariably considering first how the result may affect their private fortunes. We want men who have the determination expressed in the negro's prayer, "Lord, I wants a plenty and I don't mean maybe and I'll accept no less."

Members had demanded of the directors an investigation of headquarters practices in the past and of the League's present set-up and administration. Facts and figures suggesting one line of investigation had been submitted to each director in writing before the meeting.

When asked what they purposed to do with this presentation some of the directors exclaimed, "Ignore it." That or an evasive answer has long been the stereotyped response to any request for concise information that the headquarters has been disinclined to divulge. In this case Director Culver told the board, "We can't do that. This amounts virtually to a charge of diversion of funds. The directors have personal liability for the proper outlay of monies and we should be very unwise to treat this communication casually."

Thereupon the board appointed a committee of investigation composed of three directors under the chairmanship of Mr. Bailey. Its scope of activities will be stated in Secretary Warner's minutes as, "To make at the earliest possible moment a complete investigation of the executive organization of the League, its system of accounting, The League Constitution and by-laws, and report its conclusions and recommendations by mail to the members of the board."

This wording, it will be noticed, would confine the committee to present practices. The charge which brought about the creation of the committee relates largely to former actions that resulted in Warner's obtaining large sums of money not contemplated in his then existing contract. Whether the committee will attempt to avoid the intent of the board to investigate all charges having to do with the conduct of the present General Manager remains to be seen. Warner has on former occasions faked the minutes to make resolutions of the board read the way he wanted them to read. I hope the committee will call upon me to prove this assertion.

The committee will of necessity have to call before it the men who have been most outspoken and specific in their criticisms, notably Sumner B. Young, W9HCC, and myself, Clair Foster, W6HM. To evade doing so would place the committee in a very bad light and would cast doubt upon any report that they might make to the board. We have a list of specific questions the true answers to which members of the ARRL have the right to demand. Mr. Young and I have no wish to heckle the committee with questions on inconsequential subjects. The questions are confined to matters of vital importance to the welfare of the League and to the amateurs of America for whom the League claims the right to act.

(Continued on page 35)

# A Field-Strength Measuring Set

Tells You When Your Transmitter Is Properly Adjusted--A Valuable Aid In Tuning-Up Antennas and Feeders

By FRANK C. JONES

● A good field strength meter is not difficult to build and the total cost of parts is no higher than the cost of an ordinary thermometer. It can be built as shown, or even made up breadboard fashion.

This device is exceedingly useful around an amateur station because it provides a simple method of antenna adjustment. It can also be used as a phone monitor or keyclick monitor. Basically, the main object of all adjustments for output in a transmitter is to obtain maximum power input to the antenna. If proper adjustments can be made, a low power transmitter is often capable of outperforming some high power transmitters. Sometimes the antenna coupling is not properly adjusted, or the RF feeders may be wrong, or the antenna is cut to the wrong length. A simple field strength meter can be used to determine the correct adjustments. It tunes rather sharply and for this reason it also is useful in measuring the actual ratio of fundamental to harmonics which are radiated from the antenna. Some low-C, high efficiency circuits radiate very strong harmonics; these should not be tolerated. Proper circuit adjustments and antenna couplers will practically eliminate radiation of harmonics.

In using this field strength meter, an antenna should be connected to the antenna post of the field strength meter. The length of the antenna will depend upon the power radiated and how far it is from the transmitting antenna. This field strength meter should not be used to determine angles of radiation, but it can be used to determine the best adjustments for maximum antenna radiation. For a fixed location, a transmitting antenna will produce a field in all directions, which will be proportional to the antenna power input.

Usually a wire 50 feet long, stretched parallel to the transmitting antenna, and a few feet above ground about 50 or 100 feet away, will give sufficient meter deflection from an 80 meter antenna excited by a type 10 tube. The f.s. meter must be tuned to resonance. The antenna coupling should be adjusted for maximum meter reading for any certain power input to the final stage of the transmitter. Impedance matching for non-resonant RF lines can be accomplished because the antenna will radiate maximum power when the RF line adjustments are correct.

The location of the "Y" fanned-out portions of a 2-wire matched impedance feeder can be determined. Similarly, the point of connection to a quarter wave stub for a non-resonant two-wire line can be determined. Measurements for a single-wire feeder are a little more difficult. Care should be taken to see that the field strength meter antenna is coupled only (as far as practical) to the

transmitter antenna, not to the single wire feeder. Usually a single-wire feeder runs somewhat at right angles to the antenna; thus the pick-up or meter antenna is at right angles to the RF feeder and need only be 20 or 30 feet away from it to minimize the pick-up effect.

Useful checks on Zepp antennas can be made to determine various effects of parallel or series tuning of the feeders. Series tuning can always be used by adding loading coils in the feeders when field strength measure-

antenna and feeder to use on 5 meter automobile sets. A vertical wire,  $3\frac{1}{2}$  to 4 feet long, connected to the field strength meter which is then tuned to resonance, will provide a method of measurement for five or ten meter antennas. The distance between the transmitting antenna and the pick-up antenna would depend upon the power being used.

A telephone jack in the circuit provides a means of monitoring the radiated signals, or for checking the hum level of any individual stage of a transmitter. It works fine for checking key clicks. Phone signals are about R-7 to R-8 in an ordinary headset before the diode tube overloads. By using a short fixed antenna, such as a rod 6 inches long, the coils and dial can be calibrated and the device can be used as a wavemeter.

The field strength meter consists of a tuned circuit with conductive coupling to an external pick-up antenna, and a diode rectifier. The diode has a relatively low input impedance which would dampen the tuned circuit if connected across the entire coil. For this reason, better sensitivity and better selectivity for harmonic measurement are obtained by connecting the diode across about one-third of the coil in the tuned circuit. The voltage stepdown is more than compensated for by the increase of the coil "Q" with less diode loading effect. A good coil form of either low loss ribbed bakelite or isolantite should be used if high sensitivity is desired.

The closed circuit telephone jack and the 0-1 or 0-1 $\frac{1}{2}$  milliammeter should be bypassed with a .001 or .002 mfd. condenser, as shown. Only one 1 $\frac{1}{2}$  volt dry cell is needed for power supply if a new type 30 tube is used as the diode. The use of the new rectangular Burgess 1 $\frac{1}{2}$  volt dry cell allows the entire unit to be housed in a metal can, 5-in. x 5-in. x 8-in.

Three coils will cover the 5-10, 20-40 and 80-160 meter bands with either a 100 or 140 mmfd. tuning condenser. The coil for the 5 and 10 meter bands consists of two turns, No. 22 DSC,  $\frac{1}{2}$ -in. spacing between turns, on a  $1\frac{1}{2}$ -in. diameter coil form, tapped near the middle. The 20 and 40 meter coil consists of 12 turns of No. 22, about  $\frac{3}{4}$ -in. long, tapped at the 4th turn from the ground end. The 80 and 160 meter coil consists of 63 turns of No. 22 DSC, close wound, with a tap at about the 20th turn from the ground end. All coils are wound on plug-in forms  $1\frac{1}{2}$ -in. in diameter. The same tap which connects to the diode should also connect to the pick-up antenna. The + side of the milliammeter should connect to the negative side of the filament battery circuit.

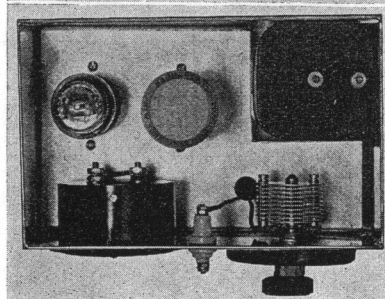
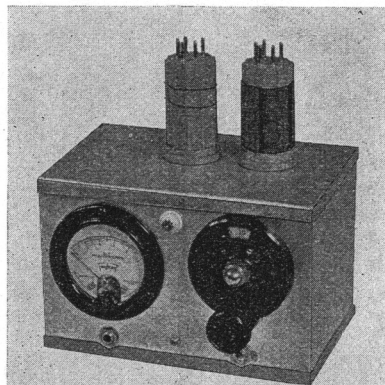

Interior and exterior views of the simple Field Strength Measuring Set.

ments indicate more actual antenna radiation.

By leaving the meter and its antenna at fixed location, various forms of antenna feeders can be tried with either a vertical or horizontal half-wave antenna, if its location is the same for each type of RF feeder. Sometimes certain types of feeders will give a great deal more antenna input than others, due to the peculiarities of the location and surrounding objects.

One recent test with this meter was to determine the best number of coupling turns feeding a twisted pair feeder transmitting antenna on 20 meters. The amount of the "Y" fan at the center of the antenna was determined as being best at about 10 inches, because the hand-twisted pair of No. 14 rubber-covered wires had an impedance greater than that of the center of the half-wave antenna.

Another use for this field strength meter would be for determining the best form of

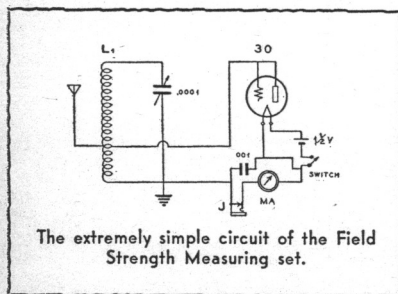

## Reason For Delay In Publication Date Of Handbook

● As was previously stated, the 288-page Handbook by "RADIO" has been delayed in order to include the data on new high-power amateur pentode tubes. The data has been received and the Handbook will be ready for delivery late in June. This time it's definite - - - no foolin'!

# \$41,499.06 Paid in Commissions to A. R. R. L. Secretary—Over and Above His Salary

● K. B. Warner entered the employ of the American Radio Relay League, Incorporated, about April, 1919, under a contract that specified he receive a salary of \$30 a week, plus 25 cents out of each yearly paid dues of members of the ARRL, plus 25 per cent of the net profits of the magazine, QST. When this contract was made the requirement for membership in the ARRL was that an applicant must own a transmitting station and be able to receive a message. The magazine, QST, was not the property of the ARRL at that time; it was a private venture of Maxim and Tuska that was afterwards bought from them by the ARRL with money borrowed from members of the ARRL.

The purpose of the employment contract was to assure Warner a definite salary and then to provide an incentive for especial effort on his part towards inducing more amateurs to join the ARRL. To this end the contract assured Warner 25 cents out of the yearly dues paid by each member of the ARRL. And as an incentive for his getting more people to subscribe to QST he was assured 25 per cent of the net profits of the magazine if, as and when it made any.

The situation was clear to all parties to the contract. There was plain demarkation between members of the ARRL and subscribers to QST. There were many subscribers who were not members because they were not amateurs. There was no intention of throwing the ARRL open to non-amateurs, and there was no intention of calling "members" those QST subscribers who had not joined the League. There most certainly was no intention of throwing wide the doors of the American Radio Relay League to all commercial radio people and other non-amateurs who were not qualified for membership. If there had been any such purpose on the part of the League officers who brought about the employment of Warner the contract would have so stipulated, for exactness of understanding is the very reason for making a contract with an employee whose remuneration is to be other than in the form of salary alone. When the remuneration is to be partly in the form of commissions a legal instrument is used for naming specifically the nature and extent of such commissions. Officers and directors of a corporation are accountable for monies paid out and they are liable for monies paid out not in accordance with the terms of an existing contract; so they are careful to see that every such contract is specific. This contract with Warner was most specific.

Now let us look at the monies secured by Warner during the life of this contract which was terminated on June 30, 1924, as well as at the monies paid to him under subsequent contracts. The following figures were obtained from ARRL records by a member after surmounting the obstacles placed in his way by President Maxim. Bear in mind that all figures in the tabulation down to June 30, 1924, are amounts secured by Warner outside of his salary.

|                   |                  |
|-------------------|------------------|
| Aug. 1, 1919..... | \$ 312.43        |
| Nov. 1, 1919..... | 585.78           |
|                   | <u>\$ 898.21</u> |

## By COLONEL C. FOSTER

|  |                   |
|--|-------------------|
| Feb. 1, 1920.....                                | 822.71            |
| May 1, 1920.....                                 | 966.33            |
| Aug. 1, 1920.....                                | 690.89            |
| Nov. 1, 1920.....                                | 1,235.41          |
|  | <u>3,715.34</u>   |
| Feb. 1, 1921.....                                | 1,755.70          |
| May 1, 1921.....                                 | 1,409.48          |
| Aug. 1, 1921.....                                | 1,343.61          |
| Nov. 1, 1921.....                                | 1,463.67          |
|  | <u>5,972.46</u>   |
| Feb. 1, 1922.....                                | 2,741.07          |
| May 1, 1922.....                                 | 2,651.20          |
| July 31, 1922.....                               | 1,987.69          |
| Oct. 31, 1922.....                               | 2,875.52          |
|  | <u>10,255.48</u>  |
| Jan. 31, 1923.....                               | 2,848.47          |
| Apr. 30, 1923.....                               | 2,151.25          |
| July 31, 1923.....                               | 1,232.77          |
| Oct. 31, 1923.....                               | 2,027.68          |
| Dec. 31, 1923.....                               | 2,062.07          |
|  | <u>10,322.24</u>  |
| Mar. 31, 1924.....                               | 4,215.33          |
| June 30, 1924.....                               | 1,484.50          |
|  | <u>5,699.83</u>   |
| -----  |                   |
| Second half of 1924 under new contract:          |                   |
| Salary, 6 months.....                            | \$3,600.00        |
| Commission .....                                 | 1,035.50          |
|  | <u>\$4,635.50</u> |
| -----  |                   |
| Total remuneration thereafter by calendar years: |                   |
| 1925.....  | \$ 7,200.00       |
| 1926.....  | 7,200.00          |
| 1927.....  | 9,364.37          |
| 1928.....  | 9,978.63          |
| 1929.....  | 9,999.96          |
| 1930.....  | 11,327.94         |
| 1931.....  | 11,800.00         |
| 1932.....  | 11,310.00         |
| 1933.....  | 9,768.09          |

It is probable that in the early years of Warner's employment there were little if any "net profits of QST", for even in the later prosperous days the profits of the ARRL came mostly from the publication of the Handbook and other booklets, not from QST. So the \$898.21 secured by Warner as commissions during his first year is probably accounted for mostly if not wholly by his 25 cents out of each yearly paid dues of members.

The ARRL was an organization strictly of amateurs and whatever property it owned by these amateurs. At first the ARRL and QST were two separate entities and their financial affairs had to be kept separate. But their activities were so interwoven that segregation of their receipts and expenditures necessarily had to be a matter of arbitrary allocation.

After the purchase of QST there was but one business entity, the ARRL, but it seems the practice of regarding QST as a separate enterprise was continued and the practice of arbitrarily allocating the receipts and expenses of the ARRL and QST likewise was continued. This situation provided opportunity for infinite variety of figure-juggling. Many expenses and receipts had to be distributed partly to the accounts of the ARRL, partly to those of QST. And the distribution was made as the man in control might decide.

When QST became the property of the ARRL the accounts of both should have been merged and the opportunity for arbitrary distribution of expenses and receipts done away with. But there sat Warner with a contract—absurdly unbusinesslike in a fraternal, non-profit organization—that provided for his getting certain commissions based on the receipts of the ARRL from membership dues, and certain other commissions based on the net profits of QST alone. If it appeared at the time of the ARRL's acquisition of QST impossible to keep distinct the two businesses then the directors should have made a new contract with Warner to remove the possibility of the arbitrary distribution of accounts favoring him.

Many errors of judgment are bound to creep in when the receipts and expenditures of two different businesses must be distributed between them. When both businesses are under the same ownership such errors are of no especial moment, but when some man has a personal interest in the earnings of only one of the businesses it is absolutely necessary that this man have nothing whatever to do with the distribution of accounts. When the distribution is made by a man who has no monied interest in the final results the errors of judgment are likely to be compensating, when he has a personal interest in the earnings of one of the businesses the errors are certain to be cumulative and to favor the business in which his interest lies. A man so situated—even a man with the best intentions in the world—is sure to favor the business in which his interest lies. A man so situated—even a man with the best intentions in the world—is sure to favor unconsciously his own interest to some extent; a man of the ultra acquisition type is bound to favor himself on every possible occasion. Nevertheless when Warner became the man to determine the distribution of accounts his contract was not altered.

Besides the possibility of favoring the net earnings of QST there started in April, 1920, the practice of calling all QST subscribers members of the ARRL. In Warner's announcement of the plan in QST for March of that year he gives as the chief reason for it, "Now that the League wholly owns QST." That was not a reason for forcing the amateurs to give up part of their ownership of the ARRL's property to QST subscribers who were not eligible for membership. But the plan did give Warner 25 cents out of the yearly subscriptions besides his 25 cents out of the dues of members. And it gave promise of still greater returns to Warner in the form of his "25 per cent of the net profits of QST", for it was highly probable that offering free membership in the ARRL to any and all persons who might be induced to

(Continued on page 32)



# Major Armstrong's Newest Discovery

## Static, Tube Noises and Fading Are Wiped-Out On the Ultra-High Frequencies

Columbia University  
in the City of New York

MARCELLUS HARTLEY RESEARCH LABORATORY  
PHILOSOPHY HALL

May 3, 1935.

Colonel Clair Foster,  
Carmel,  
California.

My dear Colonel Foster:

Of course as an old time radio man I do not expect you to believe the enclosed material any more than the leading communication engineers of the country did when it was first disclosed to them. However, I assure you that it is true.

I am sorry to say that at the moment I cannot give you any more technical details as it is a more ethical procedure to present them before the Institute of Radio Engineers, which I am preparing to do.

As far as its effect on the future of the art is concerned, I think it is going to be very similar to the effect regeneration had twenty years ago.

With best regards,

Sincerely,

(Signed) Edwin H. Armstrong.

EHA-S  
Enclosure.

● A new and revolutionary system of radio transmission and reception which wipes out the effects of static, tube noises, and fading has been invented by Major Edwin H. Armstrong, professor of electrical engineering at Columbia University.

The invention is based on principles directly opposed to accepted scientific theories of action of electrical disturbances on radio circuits. It makes ultra-short wave broadcasting practical, and assures the transmission of musical programs of a quality beyond the range of present-day broadcasting possibilities, according to Major Armstrong.

A new era in the field of point-to-point communications on ultra-high frequencies has been inaugurated as a result of tests of the new apparatus. The problem of chain television will be solved, making possible the linking up of different parts of the country, predicted Major Armstrong, who holds the medal of the Institute of Radio Engineers for his invention of regeneration, and who also invented the superheterodyne and super-regenerative circuits.

The achievement climaxes twenty years of research on the elimination of static, begun by Major Armstrong as a pupil of the late Prof. Michael I. Pupin of Columbia University.

For the past year the new apparatus has been undergoing continuous tests, which have been conducted with great secrecy, between the Empire State building in New York City and private homes in Westhampton, Long Island, and Haddonfield, N. J. Major Armstrong declares that multiplex transmission has been effectively carried out by new methods during these tests, four separate channels having been operated simultaneously between New York and Haddonfield.

A fundamental principle consists in introducing into the transmitted wave a characteristic which does not exist in the waves produced by nature. A receiving system is then used which is not responsive to waves of natural origin, but only to the waves having the special characteristic.

"The principle is carried out by the use of a discarded method of modulation known as frequency modulation," Major Armstrong states. "This method of modulation has been known for over twenty years, and the hitherto unsurmounted difficulties due to distortion and other troubles in both transmitter and receiver have caused its abandonment by all who worked with it.

"The original demonstrations of the system were made at Columbia University in

either at Westhampton or at Haddonfield were the programs interrupted by either static or fading. On the other hand in the summer time it was frequently impossible to listen to either of the 50-kilowatt stations WJZ and WEAJ on account of the static.

"In the winter time selective fading frequently interrupted the program almost as badly as static in the summer time. Neither occurred with the new system.

"The system is capable of multiplex opera-

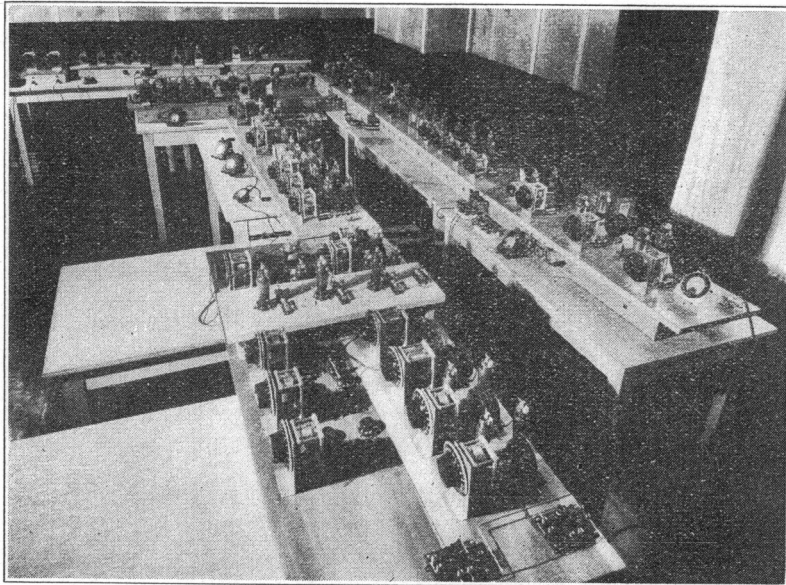

Second transmitter modulating equipment at Empire State Building, showing multiplexing apparatus (Armstrong System).

the beginning of 1934, where, it was explained to some of the leading engineers of the country. As a result of these demonstrations, the short wave transmitter on the Empire State building was placed at my disposal by the National Broadcasting Co. about a year ago.

tion, and as many as four channels have been simultaneously transmitted and received using a single transmitter and a single receiver. Some multiplexing work of great importance has been carried on with C. J. Young of the R.C.A.-Victor Co. but details of this work must come from Mr. Young.

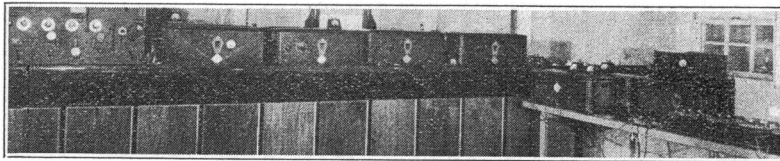

Armstrong receiving apparatus at home of Harry Sadenwater, Haddonfield, New Jersey.

"Tests have been continuous but so secret that our work passed unnoticed, except by amateurs who frequently advised the engineer in charge of the station to find out what was wrong with his transmitter. Last June demonstrations were made between the Empire State and Westhampton, Long Island, at the home of George Burghard, an old-time amateur and friend of Major Armstrong.

Subsequently the apparatus was removed to Haddonfield, N. J., near Camden, where it was located in the home of Harry Sadenwater, of the R.C.A.-Victor Co., also a friend of the amateur days of Major Armstrong. Although the power used at the Empire State transmitter was under two kilowatts, at no time during the last year

"The amount of noise reduction which can be obtained depends on the strength of the noise. One of the worst disturbances encountered on short wave length are the noises due to the motion of the electrons in the circuits and in the tubes of the radio receiving set itself. On the New York-Haddonfield circuit the energy of this disturbance is reduced to one-thousandth part without losing any of the signal strength. As the strength of the disturbances increases, the ratio of improvement becomes less.

"The action is something like that of the 'tin hat' worn overseas in the AEF, practically perfect against fragments up to a certain size, but not effective against a six-inch shell.

(Continued on page 36)

# A 100-Watt C. W. Transmitter

It Uses Three Type 210 Tubes in Parallel In the Final Amplifier, Jones Regenerative Exciter and '45 Buffer For All-Band Operation

By FRANK C. JONES

• This transmitter has some interesting features which can be used in nearly any phone or CW transmitter. The parts are inexpensive and the finished result is a CW transmitter having from 100 to 130 watts of output. A final 1 kw stage can be added if more power is desired.

The crystal oscillator uses the Jones exciter in a regenerative circuit. It consists of a 53 tube, one triode of this tube being used as the oscillator and the other section as a regenerative frequency multiplier. This 53 tube is used to drive a 45 tube neutralized buffer stage to give from 15 to 20 watts output when operated with a 400-volt power supply. The second unit consists of three type 10 tubes in parallel, giving 120 watts output in the 40-meter band when using a 600-volt power supply.

The crystal oscillator gives good output on harmonics as high as the 8th, although it is desirable to use the 2nd or 4th harmonics for exciting the 45 tube. The 53 tube tends to heat up more as the higher harmonics are used, if the plate supply is more than 375 volts. The output can be increased on the second harmonic by increasing the plate voltage to nearly 500 volts, but the tube may run hot when used as a quadrupler at such high plate voltages—unless the tube is fully loaded at all times.

For general operation, a 400-volt power supply is sufficient and miscellaneous makes of 53 tubes all seem to stand up without running wild. The oscillator gives the following output for driving the 45 tube from a 160-meter quartz crystal:

| Band | Watts Output    | Plate Supply |    |
|------|-----------------|--------------|----|
|      |                 | Volts        | MA |
| 160  | 10              | 360          | 65 |
| 80   | 7 $\frac{3}{4}$ | 380          | 67 |
| 40   | 5 $\frac{1}{2}$ | 370          | 75 |
| 20   | 2               | 380          | 68 |

These outputs were measured by means of a thermocouple in series with 500 ohms. This was in shunt to a tuned circuit which was in turn link coupled to the multiplier's tuned plate circuit. In order to match impedances, the coupler link has one turn at the driver coil and three turns at the load coil.

The high output on harmonics was due to the use of regeneration. Normally the regeneration should be set so that the 53 multiplier will not quite oscillate when the crystal is removed and the output loaded by the 45 tube.

This same oscillator gives 5 watts output on 20 meters from a 40-meter crystal with 360-volt plate supply. The oscillator is very stable and keys very nicely for CW with all of the different crystals which were tried. Some of these crystals gave very little output when used in a triode oscillator, and could not be keyed satisfactorily. Keying in the crystal stage tends to eliminate key clicks.

The multiplier coil should be center-tapped for harmonic operation, but when using it as a straight buffer stage it should be tapped about one-fourth of the turns from the grid end in order to neutralize it easily. The 53 or 6A6 tubes have a very low grid-to-plate capacity and only require a very small neutralizing condenser, unless the coil tap is off center. It was found that the minimum capacity setting of a 15 mmfd. midget condenser was too high to neutralize the 53 until the coil tap was moved toward the grid end. Normally this oscillator is used on

the fundamental by pulling out the multiplier plate coil and increasing the regeneration condenser setting so as to directly drive the 45 tube buffer stage. Either a 45 or a 2A3 buffer can be used, although the 2A3 should have a lower value of grid leak and an RF choke in series with it. The "cathode" resistor should also be about half of the value shown for the 45 tube.

The 45 buffer stage is standard in all respects, except for the use of a 1500-ohm cathode resistor which gives the tube a self-bias for keying purposes. An external C battery in series with the grid leak would accomplish the same results and no plate voltage would be wasted. As high as 24 watts output is obtained in this manner, but the

15 to 18 watts is sufficient to drive the three type 10 tubes at high efficiency. The power supply transformer gives 400 volts at 150 MA load with an 83V rectifier. About 375 volts is obtainable under load when an 80 rectifier is used. The mercury vapor type 82 and 83 give the same output as the 83V, but produce a weak hash interference which sounds like a power leak buzz in the receiver.

The type 10 tubes were chosen for use in the final stage because of their very low cost. Three were used in parallel in order to obtain over 100 watts output without running the plate current per tube excessively high. No trouble is experienced from parasitic oscillation or tube capacities. The grid circuit neutralization functions properly—neutralization being obtained with from 20 to 25 mmfd. for the three tubes in parallel. Grid

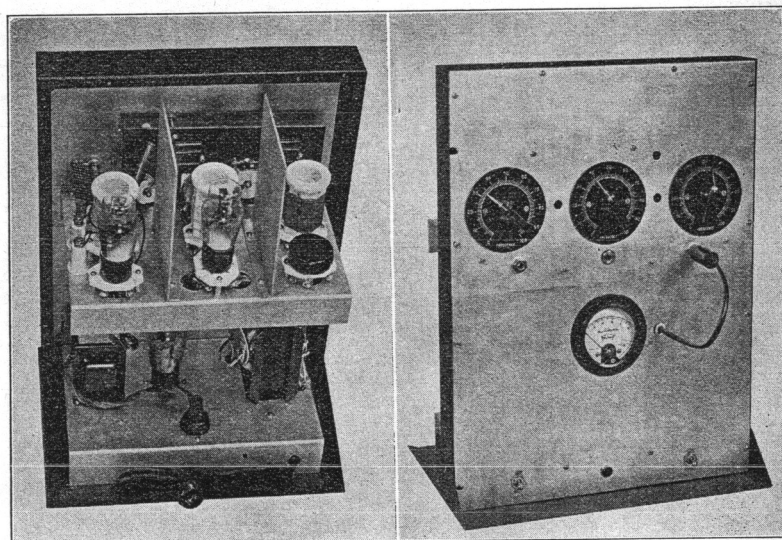

Front and rear views of the Exciter-Buffer Unit.

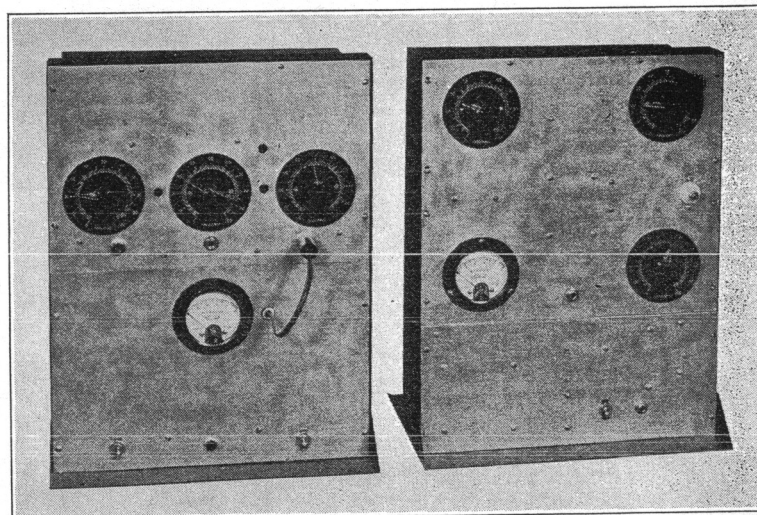

Left: Front view of the Jones Exciter and Buffer Stage. Right: Separate relay rack mounting for the final amplifier unit.

neutralization is desirable in order to use the special form of antenna coupling shown.

This antenna coupling method is very efficient and has less loss than other of the more popular types. The antenna can be matched exactly to the transmitter without and difficulty, and harmonics are suppressed. The 50 mmfd. double spaced plate tuning condenser provides a fairly low impedance path to ground or filament for the harmonics which are always generated in any class C RF stage. The plate tuning coil acts as an RF choke to second and higher order harmonics and therefore practically no harmonic power reaches the antenna tuning condenser. The latter also would by-pass harmonics, because its impedance to harmonics would be much less than that offered by the antenna or antenna feeders. This condenser, 350 mmfd. maximum capacity, acts as an impedance matching device on the fundamental frequency. For use on Zepp feeders this condenser sometimes has to be shunted by a .00025 mfd. fixed condenser, or another 350 mmfd variable condenser, because the impedance at the current loop of Zepp feeders is very low.

The circuit as shown will match a single or two-wire matched impedance feeder, an end-fed antenna, or a Marconi-to-ground type of antenna. The device will work with any length of antenna wire, within reasonable limits. This same unit is generally used at W6AJF with link coupling between the plate coil and the grid coil of a 204A stage which is used on 40 meters as a final amplifier, and on 20 meters as a doubler having an output of about a quarter kw.

The power supply, except for the 90-volt C battery, is built into the type 10 unit. It consists of a power transformer having a 200 ma. 700 volt each side of center winding, a 5-volt and a 7½-volt winding. Two type 80 tubes act as a full wave rectifier which is capable of supplying 300 to 400 ma. load. These tubes have a very high "inverse peak" rating, so by using two as shown there is no difficulty from flashover in the glass stems. Probably even more plate voltage could be impressed on them without any trouble. Using choke input and two electrolytic replacement condensers in series, 600 volts is available at an external load of about 225 to 250 ma. If a power transformer is used having a secondary which would stand a much higher rms current load, condenser filter input can be used and about 775 volts obtained at 250 ma.

In operation, the type 10 tubes show no trace of color at 120 watts output. By increasing the plate voltage to 800 or even 900, and by increasing the excitation from the 45 tube, from 150 to 175 watts of output can usually be obtained. The additional excitation could be obtained by using 90 volts fixed battery bias on the 45 tube, instead of using the cathode resistor.

In adjusting the various parts of this circuit certain suggestions should be followed. The crystal oscillator tube should be allowed to warm up for a minute before plate voltage is applied. The oscillator tuning condenser should be set at a point about half-way between the points over which oscillation takes place. This also gives about medium value of plate current and keys exceptionally well for CW. The multiplier should be tuned for maximum output on the harmonic desired by means of a 6-volt lamp and a one-turn loop of wire indicator—or a neon bulb can be used. After the proper oscillating point is determined, the regeneration condenser can be slowly increased in capacity, retuning the plate circuit with each adjustment. It will be found that the 53 tube plate current will decrease somewhat, and the output will increase. This regeneration

condenser of 15 mmfd. should not be set as far as the point of self-oscillation in the harmonic tuned plate circuit, as checked by removing the crystal. It will be found that quite a bit of feed-back can be used when the oscillator is loaded by means of the 45 tube buffer. The regeneration gives about 50 per cent more output on the second harmonic and many times more on the higher harmonics of the crystal frequency, with less plate input than without regeneration. The only precaution is to avoid excessive use of regeneration, which causes self-oscillation, with the possibility of operation on some undesired or illegal frequency. A CW moni-

tor is very useful and desirable to check the frequency.

The 45 tube buffer should be tuned for minimum plate current; without load this plate current will be nearly zero at resonance. A very small tuning condenser is used and thus it is necessary to wind the 45 plate coil with the correct number of turns. One turn of link coupling proved sufficient to drive the type 10 tubes' grid current up to 20 ma. on 40 meters. The plate current of this stage runs from 225 to 260 ma., depending on the antenna load and grid excitation. Neutralization of the type 10 tubes is ac-

(Continued on page 34)

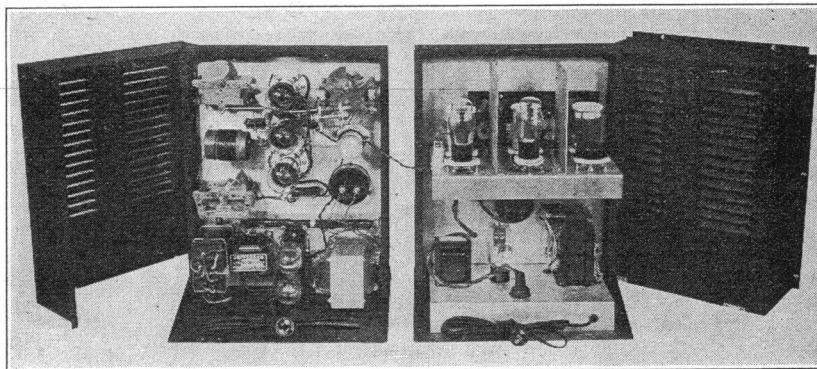

Rear views of both units. Note the dust covers for the relay racks.

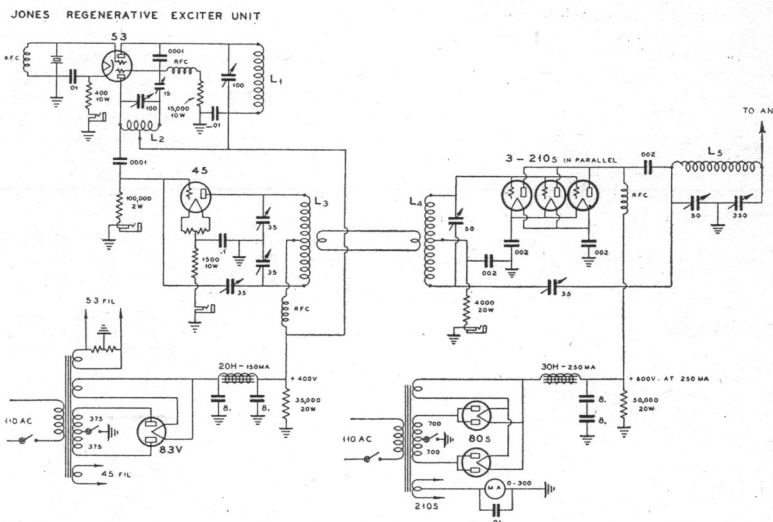

Complete circuit diagram of the 100-watt CW transmitter.

### Coil Winding Table for 100 Watt CW Transmitter

| BAND       | OSCILLATOR  | BUFFER  | 210 GRID   | 210 PLATE   |
|------------|---|---|--|---|
| 160 Meters | 53 turns, No. 22 DSC, on 1¾-in. form, close wound.                              | 60 turns, No. 22 DSC, on 1¾-in. form, close wound and center-tapped.            | 76 turns, No. 22 DSC, on 1½-in. form, close wound and center-tapped.           | 44 turns, No. 18 DCC, on 2½-in. form, winding space 2½-in. long.          |
| 80 Meters  | 29 turns, No. 22 DSC, on 1¾-in. form, winding space 1¾-in. long, center-tapped. | 62 turns, No. 22 DSC, on 1¾-in. form, winding space 2⅞-in. long, center-tapped. | 40 turns, No. 18 DCC, on 1½-in. form, close wound and center-tapped.           | 22 turns, No. 14 enameled, on 2½-in. dia. form, winding space 2-in. long. |
| 40 Meters  | 14 turns, No. 18 DCC, on 1¾-in. form, close wound and center-tapped.            | 26 turns, No. 18 DCC, on 1¾-in. form, close wound and center-tapped.            | 20 turns, No. 18 DCC, on 1½-in. form, winding space 2-in. long, center-tapped. | 12 turns, No. 14 enameled, on 2-in. dia. form, winding space 1½-in. long. |

# Getting the Most Out Of A Class B Amplifier

By RALPH O. GORDON

● The power output that can be obtained without serious distortion from a class "B" amplifier was considered in the writer's article in May "RADIO". It was stated that the safe plate loss of a tube is its limiting factor; also that proper grid excitation is assumed.

It was decided to use a pair of 801s with 750 volts on the plate and a load of 2500 ohms per tube. Fig. 1 shows the circuit used and the curves which were obtained. Two tubes with similar characteristics were selected. About 90 volts of bias is required to reduce the plate current to 4 MA, which is the no signal operating point. Battery bias was used in the tests but a "C" bias supply can be used if it has good regulation. An 83 rectifier should be used with a constant bleeder current of approximately 150 MA. Do not try to tap down on a high voltage supply for "C" bias. The total bias supply voltage should not be much greater than the required value. It is very important that the tubes require the same bias voltage. If two tubes are used that require a substantial difference in bias to obtain the 4 MA static current, serious distortion will result.

The peak plate loss of 54 watts occurs at about plus 20 volts on the grid. The average plate loss over one complete cycle is about 18 watts. The curve shows 1/2 cycle only, the other tube takes the load on the next 1/2 cycle. At plus 100 volts on the grid the grid current has increased to a value of 45 MA and the curve is approaching a vertical line so that it is not possible to go any farther without serious distortion due to grid losses.

It should be noted that the plate resistance is about 400 ohms at this point and the load resistance is six times as great, which means that the efficiency will be high.

The power that the driver stage must furnish without distortion is required only during the positive grid swing, and reaches a peak at peak grid current. While the grids are at a negative potential practically no power is required. The peak power necessary is equal to the peak grid loss of either tube, plus the loss in the bias supply and the coupling device or transformer. The peak grid loss can be determined by referring to the grid current curve of Fig. 1. At plus 100 volts the grid loss is 4.5 watts. There is also a loss in the "C" bias supply which is equal to the bias voltage times the grid current, or 4.05 watts. A total of 8.55 watts is lost in the grid circuit and must therefore be supplied by the driver stage.

The coupling transformer also wastes some power. Thus if an efficiency of 80% is as-

sumed for it, the power that must appear in the driver plate circuit is about 10.7 watts peak, or an effective power of 5.3 watts.

Because none of the receiving type tubes can deliver this amount singly, two tubes, either in parallel or in push-pull must be used. Not considering pentodes, due to their inherent distortion, a pair of 250s or 2A3s

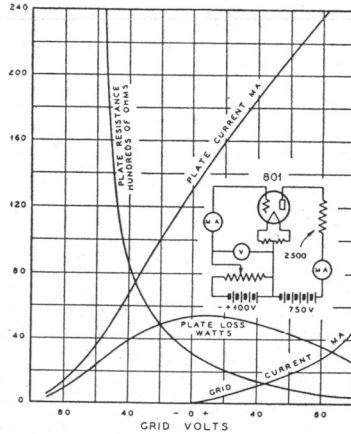

FIG. 1

can be used to deliver the power with a big reserve; but if a pair of 45s are worked a little harder than rated they will satisfy the requirements. The 45s in push-pull will deliver an effective power of 4 watts at rated input, and if the plate voltage is increased to 350 volts and the bias to 80 volts, they will operate class "A" prime and will deliver plenty of reserve power.

When a tube works into a load of varying impedance, such as is the case here, the output voltage regulation is improved if the

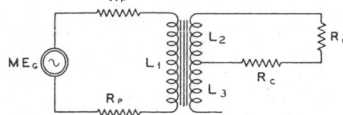

FIG. 2

minimum load impedance is several times the tube plate impedance. The plate resistance of a 45 is about 2000 ohms and for the two in push-pull 4000 ohms; consequently good regulation of the output voltage can be ex-

pected if the minimum plate load is made 15,000 ohms.

Fig. 2 is equivalent of the driver to class "B" grid current. MEg is the voltage available in the plate circuit of the driver stage. Rp and Rp are the plate resistances of the driver tubes. L1 is the primary of the coupling transformer and L2 and L3 are the two secondaries that feed the class "B" grids. Rg is the minimum resistance of one grid, the other grid offering infinite resistance at the same instant. Rc is the resistance that the "C" bias offers to the flow of grid current. Rg and Rc in series form the load on L2. One-half of the secondary must deliver a peak voltage equal to the sum of the plus grid and "C" bias voltages, in this case 190 volts. The highest voltage which it is possible to get from a class "A" tube is  $\frac{2}{3} \mu$

$\times$  Grid bias, and in this case is  $\frac{2}{3} \times 3.5 \times 80$ ,

or 187 volts for one tube and 375 volts for the two in push-pull. This is the peak voltage that will appear across the total primary.

The minimum total load impedance is  $\frac{190}{.045}$

or 4200 ohms so that the transformer must have an impedance ratio of 15,000 to 4200, or 3.6 to one, and a voltage ratio of the  $\sqrt{3.6}$ , or 1.9 to 1, total primary to 1/2 secondary.

Transformer formulae require the use of RMS or effective values of voltage and current, and the RMS value is .707 times the peak value. With 375 volts peak, 265 volts RMS can be secured for the total primary voltage. Using the familiar formula for transformers:

$$T = \frac{E \times 10^8}{f \times B \times A \times 4.4}$$

Where T = Number of turns.

E = RMS voltage

f = Lowest frequency to be reproduced

B = Flux density that the core-iron is to be worked at

A = Cross sectional area of the core in sq. inches.

The primary RMS voltage E having already been determined, f B A are the unknown variables. If the transformer is to be used for voice reproduction only, the value of "f" could be 100 cycles, but for better quality the low frequency limit will be set at 60 cycles.

The flux density B is a variable factor, depending upon the magnetic properties of the iron used and upon the magnitude of the

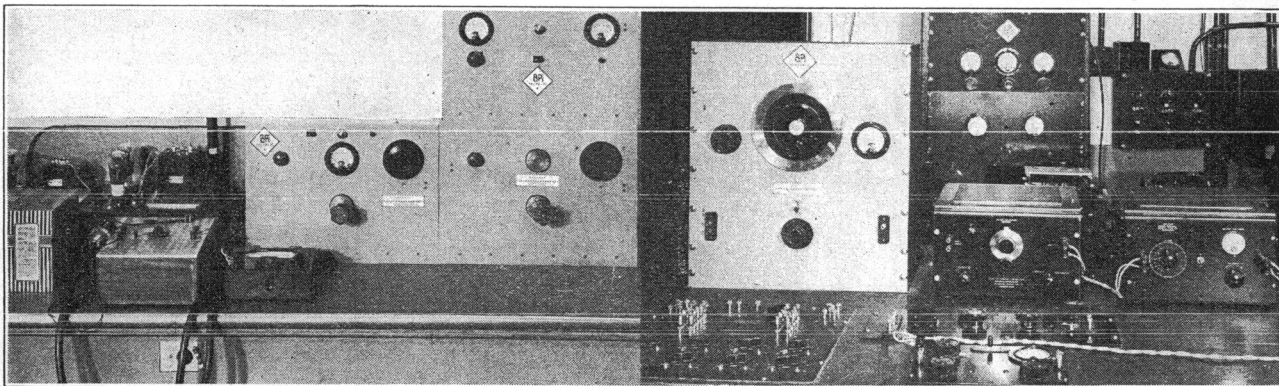

The elaborate test equipment used in securing the data for this manuscript.

signal current and any constant DC current flowing in the winding. Also the amount of air gap that is used in the magnetic circuit will influence the permeability of the iron and affect the flux density.

Unless the core is made up of "ring punchings", instead of the usual "E" or "L" shaped punchings, there will always be small air gaps in the magnetic circuit that will affect the apparent permeability of the iron. Of course, ring punchings are out of the question because the coil would have to be threaded through the ring, turn by turn, and this method of winding is not practical. Therefore the permeability, the flux density and also the inductance are all indefinite quantities. The audio fidelity that the transformer can reproduce depends to a great extent on these quantities so that a prediction of the frequency response is quite difficult unless iron of a known composition and shape is used for the core.

If commercial silicon steel is to be used for the core, a value of 30,000 is a very conservative allowable flux density. If any of the special core-material alloys are used, the manufacturers of the product supply permeability curves that can be used in determining the allowable flux density.

The cross sectional area of the core can be adjusted to suit the shape of the iron available. The greater the value of "A", the fewer the number of turns required.

The equivalent circuit of a class "A" audio output stage is shown in Fig. 3 A.

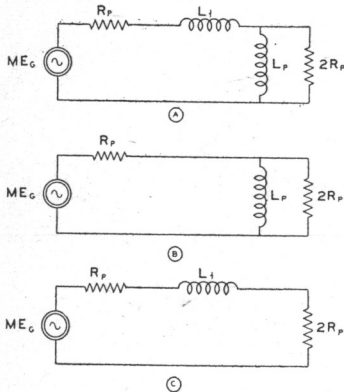

FIG. 3

Where MEg is voltage available in plate circuit  
 $R_p$  = Plate resistance  
 $L_1$  = Leakage inductance  
 $P_p$  = Primary inductance of transformer  
 $2R_p$  = Primary equivalent of load on secondary.

At low frequencies the leakage reactance is small compared to the plate resistance  $R_p$ , and thus it need not be given consideration. Fig. 3B shows the circuit at low frequencies. The impedance of  $L_p$  at low frequencies must be greater than  $2R_p$  in order not to by-pass much of the available power. The impedance of a coil is equal to  $2\pi fL$ , so that if the impedance of  $L_p$  is made equal to  $2R_p$  at 60 cycles the loss of power is only about 15%, a fair value for good frequency response.

Fig. 3C shows the circuit for high frequencies. The impedance of  $L_p$  is so high that it need not be considered as being a shunt on  $2R_p$ , but  $L_1$  must be considered because it is the leakage inductance of the transformer, which has considerable reactance to high frequencies. At a frequency where the impedance of the leakage inductance is equal to the plate impedance of the tube, a loss of power of about 10% is dissipated. Close coupling between primary and secondary must be used in order to reduce

the leakage to the lowest possible value. The insulation must be as thin as practicable, considering the voltage breakdown factor. In an auto transformer where the primary and the secondary constitute the same coil, the leakage inductance is zero. It is sometimes necessary to split up the coils and interleave the sections so as to reduce the leakage inductance. This is done in transformers where the impedances are quite high.

#### The Input Transformer

Assuming a core cross section of one-square-inch the equation is:

$$265 \times 10^9$$

$\frac{60 \times 30,000 \times 1 \times 4.4}{3340} = 3340$  for the total primary turns.

This coil must be divided into two equal sections of 1670 turns. Using the turn ratio of 1.9 to 1, it is found that there will be 1750 turns for one-half of the secondary, or 3500 for the total. Because the plate current of the 45s will be about 30 MA. each, number 33 enamel will be satisfactory for the primary; but larger wire should be used for the secondary to keep the DC resistance low. Number 30 enamel will cause a resistance of about 100 ohms for each half of the secondary. This value will change the bias voltage only 4.5 volts at full grid current. If the window in the available core material will not admit the number of turns of this size wire, it will be better to increase the core cross section, (which will reduce the number of turns), than to use small wire. If the core is made from any of the high permeability alloys, the number of turns necessary is considerably reduced, which reduces the leakage inductance and will give better frequency response.

#### The Output Transformer

If an effective power output of 87.5 watts is considered, the core cross section should be about three-square-inches if commercial silicon steel is used. Looking at the plate current grid voltage curve of Fig. 1, it is found that there is a plate current of 260 MA. at plus 100 volts on the grid. With this current flowing through the load of 2500 ohms the voltage drop is 650 volts, which is the peak audio voltage in one-half of the primary. The whole primary will deliver 1300 volts peak, or an RMS voltage of  $.707 \times 1300$ , which is 919 volts.

Each half of the primary must reflect a load of 2500 ohms on each tube so that the total primary will reflect a load of  $4 \times 2500$ , or 10,000 ohms.

The load on the secondary will be the

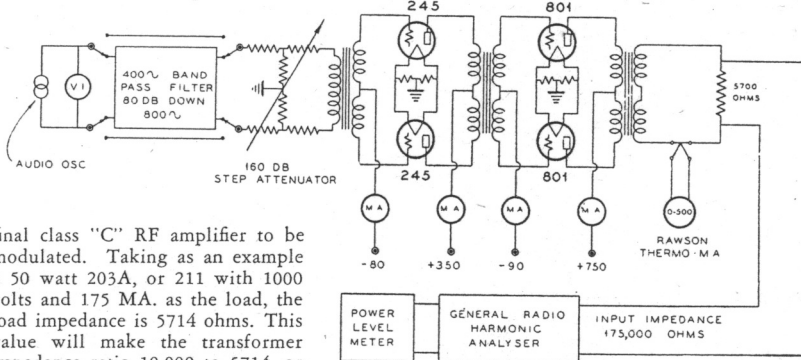

FIG. 6

final class "C" RF amplifier to be modulated. Taking as an example a 50 watt 203A, or 211 with 1000 volts and 175 MA. as the load, the load impedance is 5714 ohms. This value will make the transformer impedance ratio 10,000 to 5714, or 1.75 to 1 total primary to total secondary. The voltage or turn ratio then becomes the square root of 1.75, or 1.32 to 1. Using the formula:

$$919 \times 10^9$$

$\frac{60 \times 30,000 \times 3 \times 4.4}{3870} = 3870$  turns for the total primary and 1935 turns for each half. With the turn ratio of 1.32 to 1 the secondary

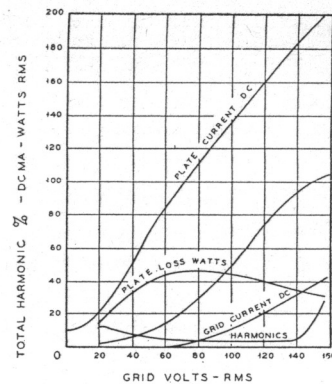

FIG. 4

will have 2930 turns. A peak current in the primary of 260 MA., or an effective current of 183 MA., will call for No. 26 enamel wire at 1500 circular mills to the amp. The RMS secondary audio current is equal to the square

The RMS Watts  
 root of  $\frac{87.5}{\text{Load impedance}}$  or  $\sqrt{\frac{87.5}{5700}}$ , which

is 122 MA. No. 27 will handle 134 MA. which is satisfactory, provided the current of the modulated amplifier does not pass through it. If an additional current of 175 MA. is considered (which is the current that the class "C" stage will draw), the transformer design would have to be recalculated. A larger core with a large air gap would have to be used in order to prevent core saturation. The secondary would have to pass a total current of 175, plus 122 MA.,

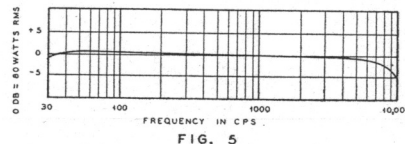

FIG. 5

or 297 MA. The larger core with an air gap would increase the length and the number of turns on both primary and secondary. The leakage inductance would increase, and the frequency response would fall off at both ends of the audio spectrum. Therefore the secondary should carry no DC if good frequency response is desired. The modulation choke that should be used in parallel with the secondary, to pass the final amplifier current, should have an impedance of at

least twice the load impedance, or in this case about 12,000 ohms at the low frequency limit. A 30H 175 MA. choke will be satisfactory. The blocking condenser should have a capacity of 2 Mf. or more if extreme low frequencies are desired in the output. A

(Continued on page 84)

# 5-Meter Superheterodyne of New Design

By FRANK C. JONES

• This is a new type 5-meter superheterodyne which has certain advantages over any other yet shown. The circuit is simplified and is easier to put into operation.

The receiver has a stage of semi-tuned RF, a second detector and a power audio stage. The entire set is built on a chassis 8-in. x 17-in. x 1½-in. deep, and fits a 7-in. x 19-in. x ⅛-in. standard relay rack panel. A small enclosed five-inch dynamic loudspeaker makes the set complete and gives very good speech quality of reproduction.

The RF stage is resonant at the top end of the 5-meter band and actually adds some gain in the form of signal-to-noise ratio. This RF stage is somewhat similar to that used in more elaborate super-regenerative receivers and accomplishes the same purpose. It eliminates receiver radiation, although in the case of this detector circuit, the radiation is small as compared with a super-regenerative detector. The advantage of an RF stage is that it eliminates antenna resonance from the detector circuit. The latter should oscillate mildly over the entire tuning range; antenna resonance usually causes dead spots. A variable regeneration or oscillation control permits maximum sensitivity to be used, when desired. Semi-variable RF coupling is used to the detector circuit in order not to load this circuit too much, and also to prevent RF oscillation. The detector oscillates; thus the impedance of this circuit is high and the RF stage actually gives some gain.

The detector uses a grid-leak for obtaining smooth oscillation and detection. The IF frequency is so low that a grid-leak detector is quite efficient. A cathode RF choke is used instead of a critical cathode tap on the grid coil. This RF choke forms a common grid and plate impedance so that the tube oscillates at the frequency determined by the tuned grid circuit. The value of screen and suppressor grid voltage, as well as the size of grid condenser and leak, are chosen so as to obtain oscillation but not super-regeneration. The detector heterodynes the five-meter signals into the IF amplifier.

The IF amplifier uses two stages of moderate gain. The values of resistors and capacities are chosen so as to amplify from about 10 or 15 KC up to 90 or 100 KC. This wide band is sufficient to allow reception of 5-meter signals emitted by modulated oscillators. The values of capacities and grid-leaks are such as to prevent amplification of audio frequencies. It peaks at about 50 KC, but the response curve is quite flat and broad. Eliminating tuned circuits results in the elimination of magnetic fields and reaction between stages. This greatly simplifies construction, because an IF transformer is simply two resistors and a small mica condenser.

The second detector is somewhat different than normally used in most receivers. It uses a type 41 tube with the screen grid tied to the regular input grid and the tube thus acts as a high mu triode. It really acts somewhat like a class B tube, in that grid current starts to flow as soon as a signal is impressed. The rectified grid current is used to obtain semi-AVC action in order to prevent overloading on strong signals. This voltage is fed back to the grids of the two IF amplifiers, through resistive filters, so as to prevent too great a signal being built-up across this detector circuit.

The audio amplifier uses a 41 or 42 tube as a regular pentode in order to give loudspeaker volume in the output. An audio volume control is used and the set functions

(Continued on page 34)

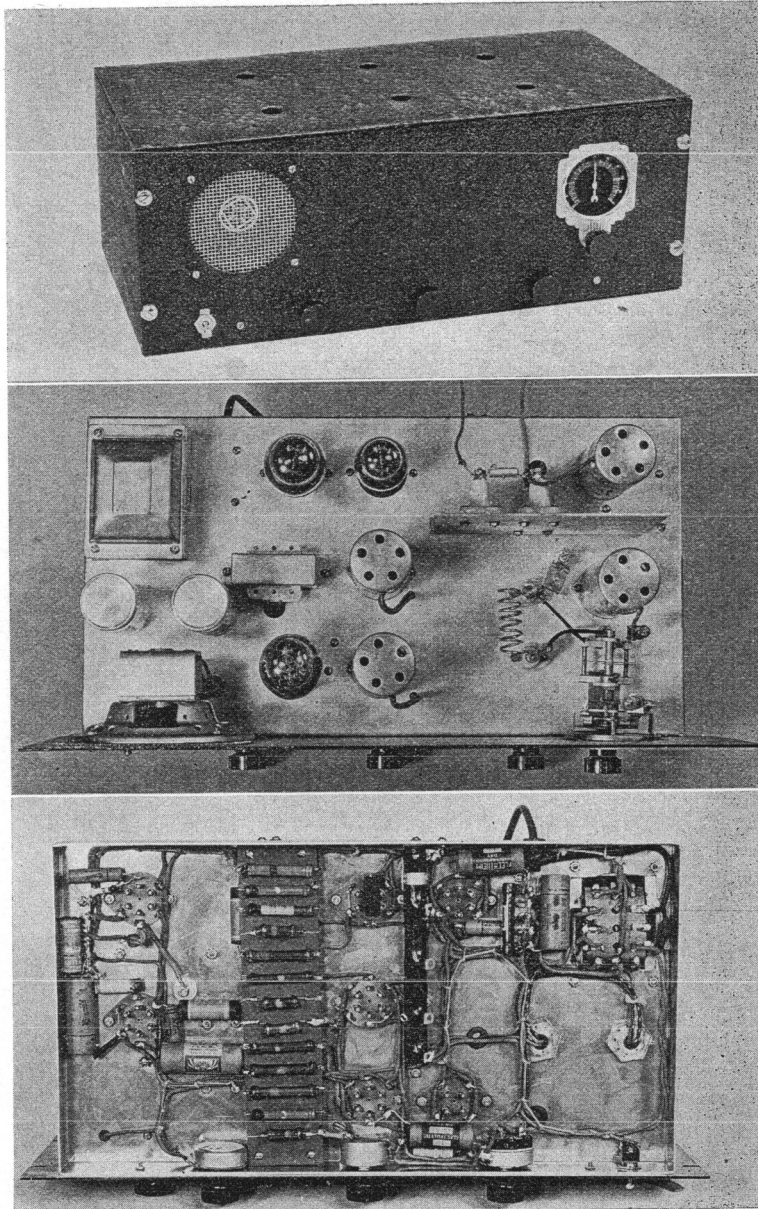

The 5-meter super should be laid-out as shown in the above illustrations.

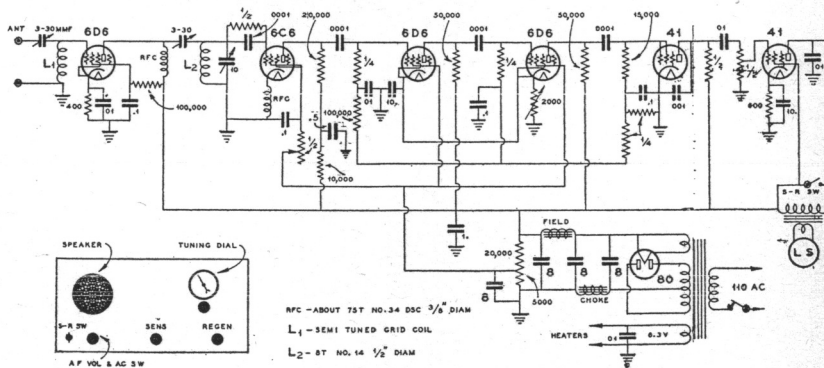

RFC - ABOUT 75T NO. 34 DDC 3/8" DIAM

L<sub>1</sub> - SEMI TUNED GRID COIL

L<sub>2</sub> - BT NO. 14 1/2" DIAM

FRANK JONES' 5 METER SUPERHETERODYNE CIRCUIT

# A "Very Low Wave" Receiver

By FRANK C. JONES

• Here is a superheterodyne receiver that covers the ultra-short wave range from 2.4 to 10 meters. Ordinary tubes are used throughout and it is only necessary to change one coil when tuning over the next range. Quite a few coils are needed because the tuning condenser has a small maximum capacity of about 15 mmfd in order to spread-out the tuning ranges. 2½ to 10 meters is a very great frequency range, being nearly 100,000 KC more than the present-day all-wave broadcast receiver coverage.

This receiver is built with a small magnetic speaker included, in order to provide loudspeaker reception in either a car or at home. For this reason it is built so that it can be operated from a power pack or from

Control of the intensity of oscillation is obtained by means of a 50,000 ohm potentiometer which controls the voltage on the screen-suppressor grids of the first detector. The plate circuit, like any electron-coupled detector, feeds into the IF amplifier. The antenna is loosely coupled to the control

to take care of oscillator drift and also to enable the reception of modulated oscillators, such as are universally used on these short wave bands. The advantage of a superheterodyne lies in its greater sensitivity to weak signals and lack of the terrific background noise which is present in super-

This receiver has been designed so that either the new Acorn pentode or standard 6.3 volt tubes can be used. The circuit diagram shows the 6.3 volt series tubes, which have proved entirely satisfactory for operation down as low as 2½ meters.

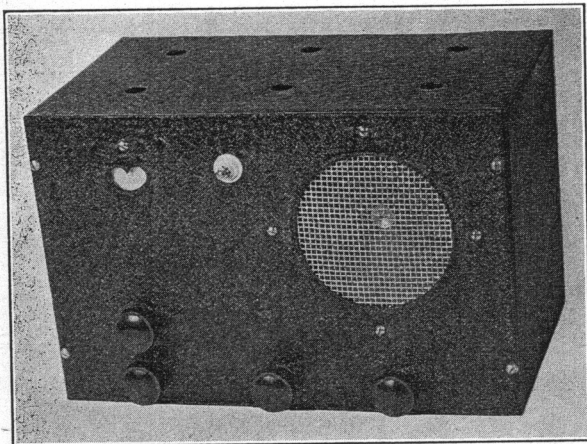

Front view of "Very Low Wave" receiver.

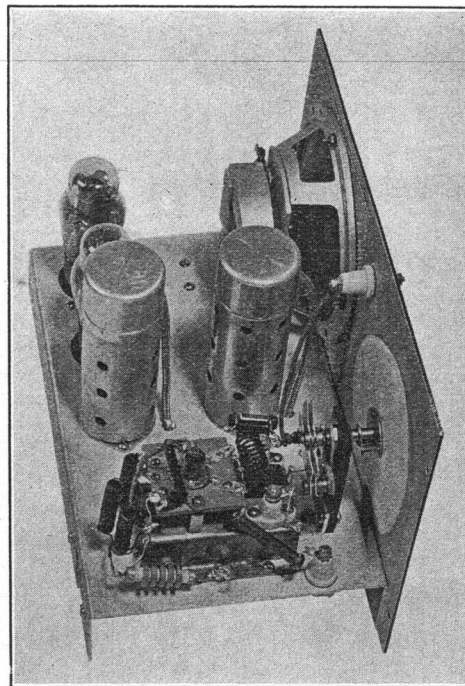

Showing tiny Acorn Pentode and mounting sub-panel.

B batteries and a 6 volt storage battery, connection to either being made by means of a plug and cable at the rear of the chassis. A magnetic speaker requires no field power supply, and some of the new small type speakers give very good quality on speech reproduction.

The circuit is an oscillating autodyne first detector, two stages of IF amplification, second detector, and audio power stage. There are several novel features in the circuit. The first detector uses a 6C6 screen-grid tube which will oscillate down to less than 2½ meters, although some tubes require 67½ volts on the detector screen instead of 45 when this highest frequency range is used. Not over 45 volts should be used for the other coil ranges. Oscillation is obtained at 2½ meters by using a circuit in which all parts are "floating" with respect to ground RF potential. The control grid, screen and suppressor grids, and cathode are all above RF ground. This circuit is quite similar to others previously shown for 5-meter superheterodynes, with the exception that the tuning condenser is not grounded, and the screen and suppressor grids are fed through an RF choke. Oscillation is obtained by the use of a small 60 turn RF choke in the cathode lead.

grid circuit by means of one or two turns of twisted insulated wire over the antenna binding post. This coupling must not be too great, otherwise antenna load and resonance will prevent detector oscillation.

The IF amplifier uses resistance coupling, which has proven so satisfactory for use in ultra-short wave superheterodynes. The values of coupling condensers and resistors are chosen so as to allow amplification from about 10 or 20 KC up to 100 KC with a very broad resonance curve. This is necessary in order

regenerative receivers. With the newer second detector circuits and other circuit adjustments, the superheterodynes are no more sensitive to auto ignition interference than the super-regenerative receivers. The first 5-meter superheterodyne receivers were extremely sensitive to passing auto ignition interference, but this effect has now been greatly minimized.

The first detector has its plate voltage fed through two resistors with a ½ mfd. by-pass (Continued on page 16)

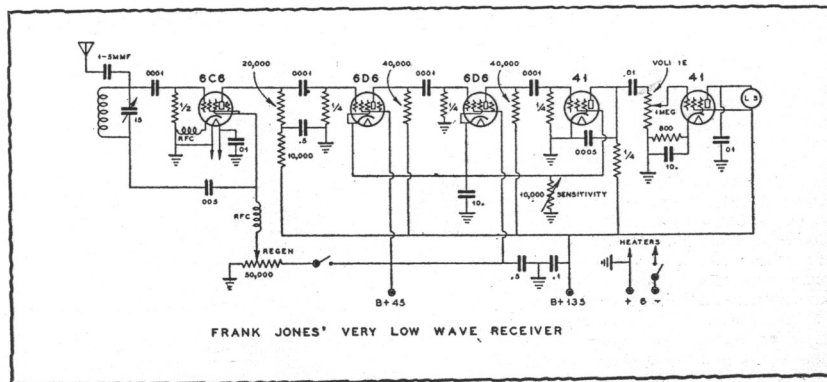

condenser to ground between them, in order to prevent oscillation at the IF frequency. The values of resistors and condensers are not critical and 10 per cent to 15 per cent variation in values will cause no difficulty. Sensitivity is controlled by means of cathode bias voltage variation on the two IF stages.

Several second detector circuits and tubes were used; the one here shown has proven most satisfactory. It uses a 41 tube as a pentode with very low screen voltage and with resistance coupling to the power audio stage. The small positive voltage on the screen grid is obtained by connection to the IF cathodes. These cathodes are by-passed by a low voltage 10 or 25 mfd electrolytic condenser and no common coupling trouble is experienced. This detector will supply enough output to overload the 41 audio stage and loudspeaker. The audio quality is very good. The detector sensitivity to sharp impulses, such as auto ignition noise, is remarkably low.

The audio stage uses a 41 tube with the cathode bias of 800 ohms in order to somewhat reduce the plate current. If more than 180 volts of B supply is used, or if the magnetic speaker resistance is more than 1000 ohms, an output transformer or choke and condenser should be used. It is usually a good plan to keep DC current out of any magnetic speaker and even at low plate voltage it is necessary to sometimes reverse the speaker leads. The DC plate current, if allowed to find its way into the speaker coil, should flow in such a direction as to aid the permanent magnet field.

The dial consists of a celluloid disc fastened to the condenser shaft and driven by a small vernier friction drive on its outer edge. Some dials which have loose metal gears, or metal-to-metal drives, are noisy on the ultra-short wave bands. The old-style bakelite dial is one of the best for use in these sets because the tuning is not extremely critical. Another source of noise which can be avoided is to use a midget tuning condenser with only one bearing and which has a good spring wiping contact to the rotor. If a condenser with two metal bearings is used, the noise will become unbearable after a little use.

The IF tubes are shielded. The grid leads are also shielded, in order to prevent IF oscillation and to provide a certain value of grid-to-ground capacity for correct IF band-pass characteristic. The resistors and mica coupling condensers can be conveniently mounted under the chassis on a resistor mounting strip, as shown in the picture.

The chassis and front panel are made of No. 12 gauge aluminum. The panel is 7-in. x 11-in. The chassis is in the form of an inverted "U", 1 3/4-in. deep, 6-in. wide and 10-in. long. A sheet-iron metal cabinet can be used to shield the set electrically and mechanically. This cabinet can be fastened by means of four self-tapping screws through the front panel. The loudspeaker should have a wire screen grill in front of it. Several large holes in the top of the cabinet furnish an acoustic outlet for sound coming from the rear side of the loudspeaker and also serve as ventilation holes.

It is desirable to calibrate each coil by means of Lecher wires and ultra-high-frequency wavemeters, as was done with this set. The values of coil ranges will vary with different types of tuning condensers and length of leads. It is important to keep the leads very short, if the range below 5-meters is desired. One method of obtaining extremely short coil to condenser leads is by splitting the stator plates down the middle, so that connections are made to each side of the stators. The condenser then becomes a split-stator tuning condenser and most of the tuning is done through 90° of rotation instead of 180°. If a split-stator

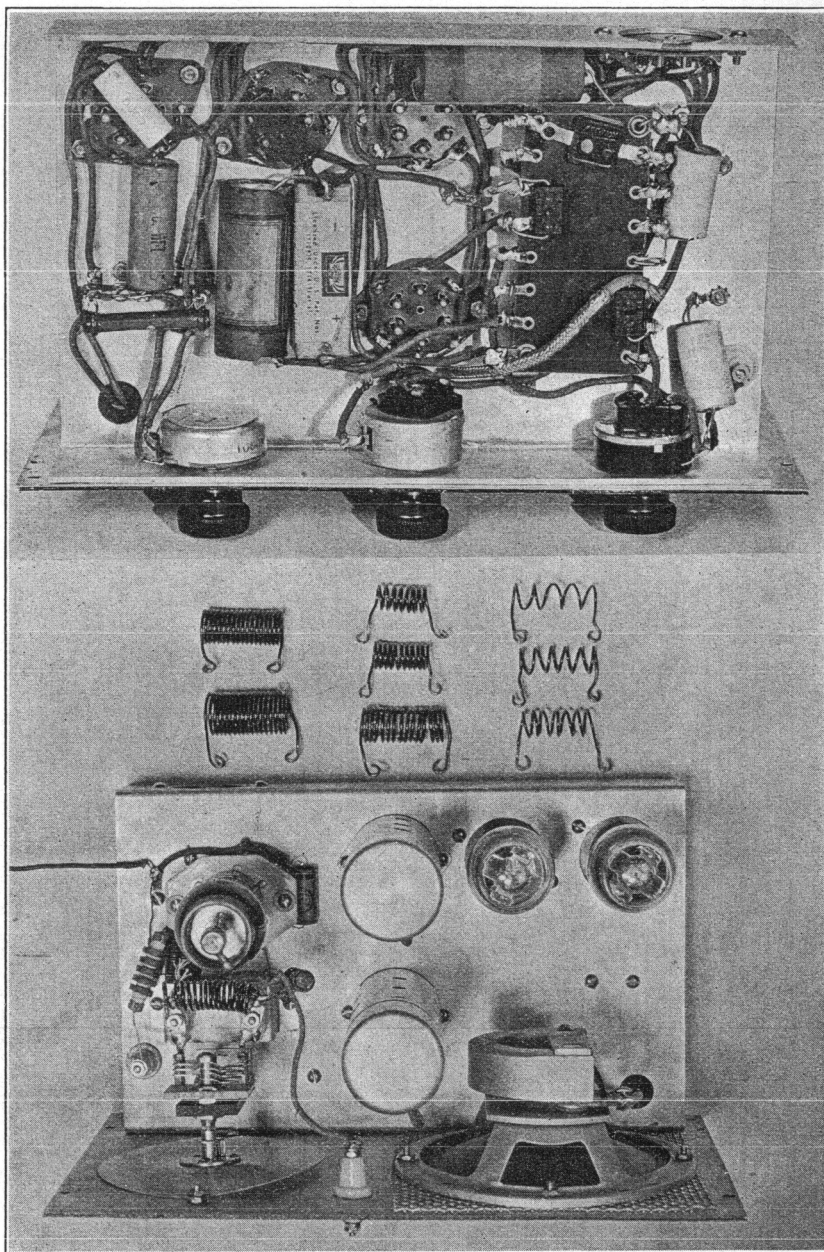

Under-chassis view of the receiver and (lower view), looking down into the receiver. Note that the 6.3 volt tube is here used in place of the Acorn Pentode. The six coils are clearly shown in the illustration.

### COIL DATA (Wound With No. 14 Wire)

| Rreq. Range<br>in MC | Length  | Inside<br>Diameter | No. of Turns |
|----------------------|---------|--------------------|--------------|
| 120-110              | 1 1/2"  | 3/8"               | 5            |
| 110-100              | 1 1/8"  | 3/8"               | 6            |
| 98-88                | 1 3/8"  | 3/8"               | 7            |
| 88-78                | 1"      | 3/8"               | 8            |
| 78-66                | 1 1/8"  | 3/8"               | 11           |
| 66-55                | 1 3/8"  | 3/8"               | 15           |
| 55-42                | 1 9/16" | 1/2"               | 15           |
| 45-37                | 1 3/8"  | 1/2"               | 18           |
| 38-30                | 1 1/2"  | 5/8"               | 18           |

The Cathode RF Choke has 60 turns of No. 22 DSC wire, 1/4" diameter.

condenser is used, it is necessary to use about 7 plates instead of 3, as in the usual tuning condenser. The insulation through-

out the RF circuits is isolantite. All coils are self-supporting. Loss-producing coil forms should not be used.



# Home-Made Transmitting Condensers

By FRANK C. JONES

• The condensers here shown were home-constructed for high power use. A plate spacing of about a half inch is used and these condensers will stand RF voltages much greater than those encountered in amateur stations using the full legal input of one KW into the final stage of the transmitter.

The formula used in calculating the size of plates necessary is  $C = \frac{.225 A}{d}$ , where C

is in mmfd., A is in square inches of "active dielectric" and d is the thickness of dielectric. In the case of the single section condenser here shown, the active area is three times the overlapping area of one plate, or 75 square inches. The value of d is nearly a half inch . . . .45 inches to be exact, and consequently C figures out as  $37\frac{1}{2}$  mmfd. These condensers should stand considerably over 10,000 volts with this plate spacing.

One cause of condenser failure in higher power amateur stations is in poor or insufficient amount of insulator supports. The insulation gets warm and breaks down under operation. The use of 3-inch porcelain stand-off insulators should eliminate this trouble.

The parts for these condensers can be readily procured at moderate cost, and with the aid of a few wooden blocks, a hammer and a vise, all of the iron and aluminum can be bent into shape. The aluminum plates are made of No. 12 gauge pieces, 5-in. x 6-in. All end plate pieces are made of pieces 2-in. x 5-in., bent into a channel shape with  $\frac{1}{8}$ -in. lips, or turned-up edges. All corners and all edges should be rounded with a file and then polished in order to prevent voltage break-down due to sharp edges. Iron supports and braces are made of  $\frac{1}{8}$ -in. x  $\frac{3}{4}$ -in. stock.

The base and end supports are made of quarter-inch bakelite, 8-in. x 14-in. for the single section condenser, and 9-in. x 16-in. for the split-stator condenser. This increases the cost and a cheaper, yet satisfactory substitute is tempered Masonite or Celotex. Even dry wood ( $\frac{3}{4}$  or 1 in. kiln dried finished boards) should be satisfactory. The RF insulation is taken care of by the porcelain standoff insulators.

The two stand-off insulators for the single section condenser are mounted on a vertical subpanel, 5-in. x 3-in., with their centers  $2\frac{1}{2}$ -in. above the main base mounting. This vertical panel is fastened rigidly to the horizontal base by means of a strip of  $\frac{1}{2}$  x  $\frac{1}{2}$  right-angle dural and braced at 45° angle by means of an iron strip,  $3\frac{1}{2}$ -in. x  $\frac{3}{4}$ -in. x  $\frac{1}{8}$ -in. The stator plates are fastened to the ends of the two insulators by reversing the mounting screws so that only the round head portion protrudes through the aluminum.

The rotor of this condenser is mounted on a quarter-inch brass shaft which is about 10 inches away from the rear stator supporting strip. This shaft has two bearings. The lower bearing fits into an old telephone jack and the upper bearing fits into quarter-inch holes drilled in the two iron rotor supports.

A General Radio vernier dial makes a nice drive for these condensers and also locates the rotor spacing with respect to the stator plates. The center of the dial knob should be drilled out so that the rotor shaft will slide clear through the dial knob. The dial then rests against the top of the telephone jack, with a washer or two as shims, because the dial normally mounts about  $\frac{1}{8}$ -in. away from the panel.

In the single section condenser it is necessary to add a rotor brace to the shaft to

hold the rotor plates out at right angles to the shaft. The shaft itself is flattened slightly with a file so as to provide a flat surface for attaching the rotor plates. The shaft and rotor should be located so that with the plates fully meshed, the ends of the rotor plates clear the round-head stator mounting screws by a half inch.

The two iron rotor braces are  $7\frac{1}{2}$ -in. long in the case of the single condenser, and  $8\frac{1}{2}$ -in. long for the split-stator job. These can best be formed and fitted into position after the stator is mounted, and when the rotor is in its relative position.

The split-stator condenser has two separate stator sections and the back vertical support is made 5-in. wide and  $6\frac{1}{2}$ -in. high. This panel is fastened along the base and also supported with a slanting iron strap brace so as to make it rigid. The rotor is made of four plates, as shown, with the middle two plates fastened together at the free end to give a little additional rigidity. It is not entirely necessary to use this extra

end support because its added weight probably offsets the bracing effect. The back edge of the rotor section fastens together with a  $\frac{1}{2}$ -in. strap along one edge, and to the flattened portion of the  $\frac{1}{4}$ -in. shaft with four machine screws. The shaft has a lower bearing in the form of part of an old telephone jack, while the two iron braces act as the upper bearing. The vernier dial holds the rotor in position with respect to plate spacing between the stator plates. Vernier dials are necessary because of the ease of rotation; the vernier action tends to lock the condensers in any given position. Maximum to minimum capacity occurs over approximately a 90° swing of the rotor plates.

For those having access to a sheet metal brake, the pairs of plates can be made out of single pieces of aluminum, 5-in. x 13-in., with a 1-in. end section, leaving the two finished plates 5-in. x 6-in. in size. The aluminum can be bent at right angles in the brake for one plate, the other right angle bend started, then finished with a block and vise and hammer. This construction will provide a more rigid structure than in the assemblies shown below.

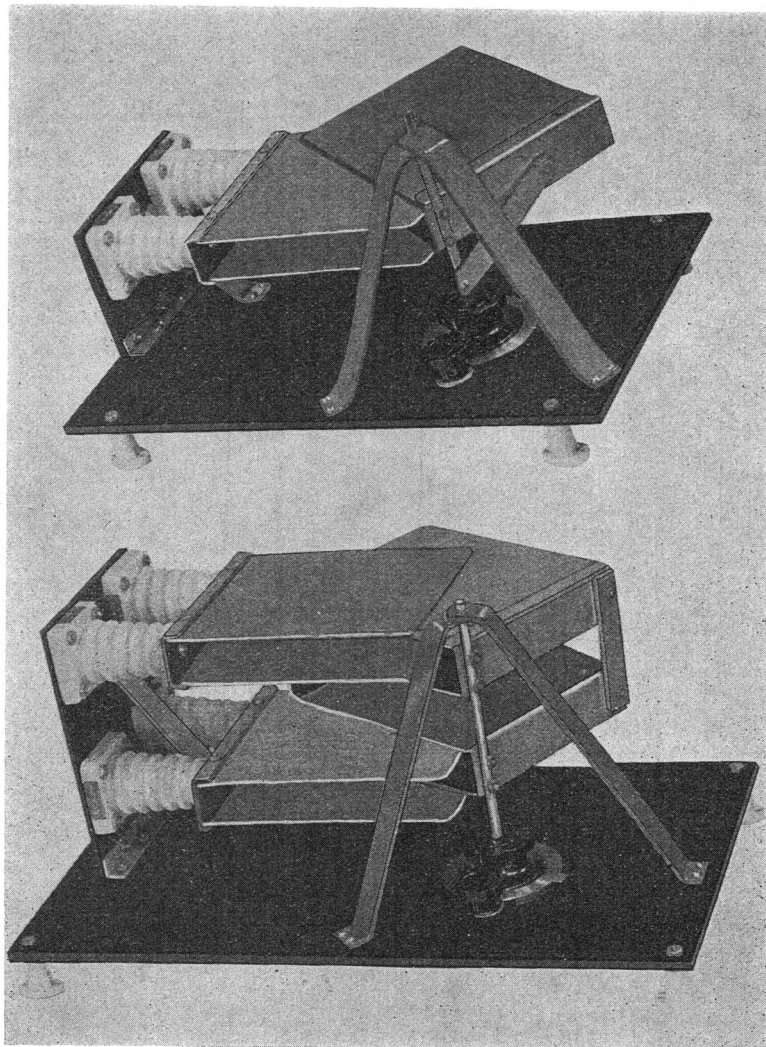

Two types of home-made high-voltage amateur transmitting condensers.

# A High-Power Output Stage for Small Receivers

By I. A. MITCHELL\*

● The great majority of small receivers manufactured for amateur and BCL use incorporate a pentode output stage. While this is excellent practice from the economical and manufacturing angle, it is common knowledge that the pentode tube is not an ideal audio amplifier. The use of a pentode output tube necessarily means comparatively high harmonic content and limited power output. Glenn H. Browning, who designed the well known "Browning 35" super tuner, recently suggested to the writer that a simple inexpensive high power output stage is actually a necessity for such receivers. The amplifier described below was the result of Browning's suggestion, and while it was originally intended for operation with the "Browning R-35", it is suitable for high power conversion of any pentode output radio receiver.

In the past, when one desired to increase the power output from a radio receiver, it was customary to purchase or construct a complete audio amplifier which took the detector tube output and amplified it to the final audio level desired. With modern high fidelity A prime circuits, this procedure is not warranted. The entire audio output originally available from the receiver can be used to drive a single stage output amplifier, thus simplifying the changes made necessary. When this method of high power conversion is used, a number of advantages are effected, namely:

1. Practically no changes are necessary in the original receiver.
2. No reduction in plate current is effected on the original receiver, and consequently full excitation can still be obtained for the loud speaker in its original circuit.
3. There is no waste power consumption—all tubes and components are in full use.
4. The construction of a single-stage amplifier is considerably simpler than that of a complete audio unit.
5. Coupling from the receiver to the power stage is at high level, minimizing the possibility of hum pickup or audio feedback.

After careful consideration of all the tubes available for an output stage suitable for radio set application, the 42 tube was found to be most advantageous. This tube when used as a triode in push-pull A prime, provides high audio power and low distortion. Fig. 1 illustrates typical operating characteristics for a pair of 42s when used with fixed bias. Examining the plate current curve, it is seen that the static plate current is only 40 milliamperes, but when it is driven it increases to almost 100. This is quite a factor in the economical side of A prime tube operation. It means that the average plate power taken by the output stage is half that which would be taken by an equivalent straight class A amplifier. This economy, however, is not obtained at the expense of fidelity. Examining the distortion curve, it is seen that up to 5 watts the harmonic distortion is less than 1%. Better fidelity than this cannot be hoped for from any amplifier. At higher output, the harmonic content increases, but even at 18 watts, only 5% distortion is encountered. The present standard for high fidelity is 5% distortion, but this percentage is normally used for the value of maximum undistorted output.

It is well to note here that A prime amplification is in a sense a form of class B amplification, and the precautions normally taken with class B circuits should also be applied to A prime. When driven to 18 watts out-

put, the 42 tubes take over 20 mills in grid current. This represents an appreciable amount of grid power which must be supplied by the driver tube. Fortunately, the 42, 2A5, or similar pentode, when operated as a triode, delivers over 600 milliwatts power at low distortion. This is more than enough driving power if the input transformer has high transfer efficiency. As in class B, the grid current is drawn by only one grid at a time; that is, the grid which is positive at that portion of the cycle. This

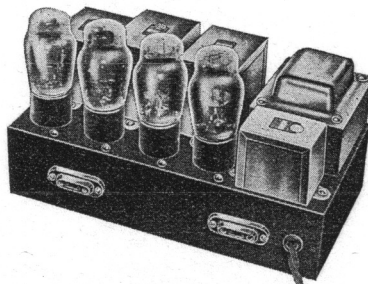

FIG. 2. General appearance of the amplifier unit.

means that the input transformer must be designed to have high efficiency not to the entire secondary, but individually to each

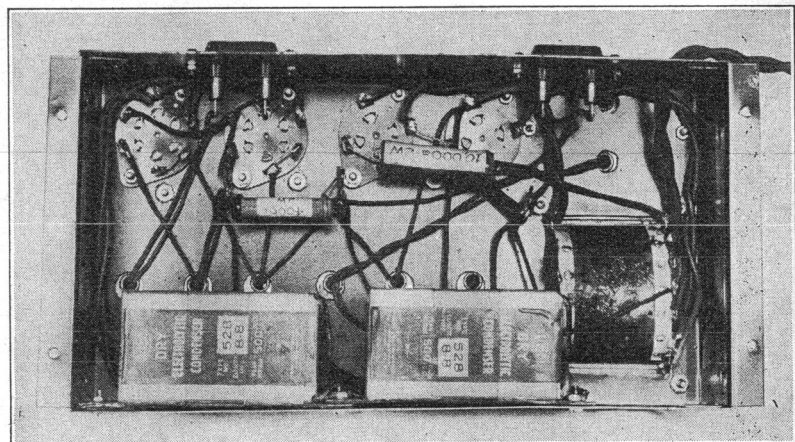

FIG. 4. Under-chassis view of the amplifier.

half of the secondary. Interleaved coils are essential for this reason.

As the plate current swings through an appreciable range, in A prime, it is essen-

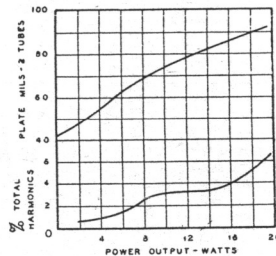

FIG. 1. Characteristics of 42s in fixed bias A-prime.

tial that the plate supply have fairly good regulation. While choke input tends to improve regulation, it necessitates the use of two filter chokes. This would be unnecessarily expensive in a single stage amplifier. After some experimentation, it was found that using an 8 mfd. input condenser and a good smoothing choke, 8% regula-

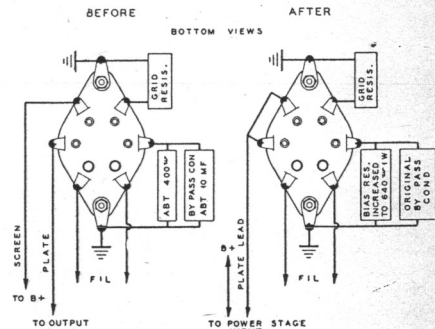

FIG. 5. Change of pentode to triode. Bias resistor is increased; screen and plate are joined.

tion could be obtained from the power supply from zero signal to maximum undistorted output, and the hum level was not measurable. Similar to the conditions encountered in the driver transformer, the audio output transformer must be designed with high efficiency to each half of the

primary, rather than the whole primary. This is due to the fact that each tube supplies more than half of the audio output for that portion of the cycle in which its grid is driven positive. Furthermore, during the portion of the cycle when one tube is drawing grid current, its plate current rises

(Continued on page 30)

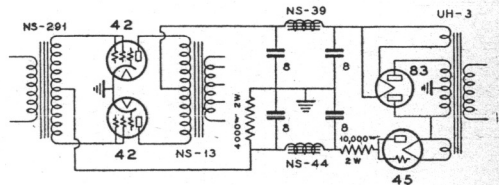

FIG. 3. Complete circuit of the fixed-bias power stage.

\* Chief Engineer, United Transformer Corp.

# The "Les-Tet" Junior Transmitter

By FRANK LESTER, W2AMJ\*

● Correspondence with amateurs all over the country, resulting from the writer's various articles in "RADIO", indicate strongly that there is a demand for small, simple transmitters that the ham can assemble himself, but that use some sort of a metal chassis instead of the traditional and outmoded breadboard. Wooden baseboards are all right for experimental layouts, but a neatly finished, black enamel box makes the station look a lot more business-like.

To meet this demand, the writer has modified the "Les-Tet" circuit (described in detail in the November and December, 1935, issues) and embodied it into a compact steel chassis that measures only 10 by 7 1/4 by 5 inches overall. Receiving type components are used throughout and are altogether adequate. The electrical circuit and the mechanical construction of this "Les-Tet Junior", as the transmitter has been named, are far simpler than those of most amateur receivers. The outfit really can be assembled and wired in one evening—and the writer doesn't mean one of those evenings that begin at 4:00 in the afternoon and end at 2:00 the next morning!

Two inexpensive receiving tubes are used. V1 is either a 56 or a 76, V2 a 59 or a 42, depending on the available power pack. As the tendency nowadays is definitely toward standardized use of the 6.3-volt tubes, the 76-42 combination is recommended for the amateur who will build a power pack with the transmitter.

The 56 or 76 acts as the crystal oscillator, with the crystal connected between grid and cathode. The "plate" tank circuit, consisting of L1 and C1, is actually between the cathode and ground, the plate being fed directly through a small RF choke. A single closed circuit jack, J1, permits the temporary connection of a milliammeter for tuning purposes.

The oscillator tube 76 is direct-coupled to the amplifier-doubler. If the connection between the cathode of V1 and the control grid of V2 looks a bit peculiar, study the circuit a moment and you will see that the grid-cathode input circuit of V2 is simply across the oscillatory circuit L1-C1, the com-

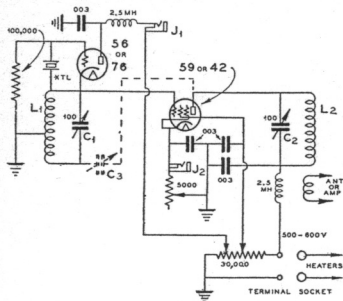

Circuit diagram of the "Les-Tet" Junior. V1 in the text refers to the oscillator tube. V2 refers to the 59 or 42.

mon return path being the "ground", or the chassis. V2 is thus driven by the oscillatory power developed in L1-C1, and works as either a straight amplifier on the crystal fundamental or as a multiplier-amplifier on its harmonics.

For straight crystal-frequency operation, the amplifier is readily neutralized with the aid of condenser C3. Out of phase neutralizing voltage is developed between the bottom of L1 and the grounded tap on this coil.

The 5000-ohm variable resistor in the

\* Engineer, Wholesale Radio Service Co., Inc.

cathode leg of V2 is a bias adjustment, and is particularly useful in obtaining maximum output when the tube is acting as a harmonic amplifier. The jack J2, in the cathode circuit, serves for a plate milliammeter, during the tuning process, and also for the key.

The plate and screen circuits are conventional. The DC for the plate is fed through the plate coil L2, the RF circuit to the tube being completed through a .003 mf. condenser. As this condenser is right across the high voltage plate supply, it must be a good mica unit.

To simplify the wiring between the transmitter and the power pack, a 20,000-ohm wire wound divider resistor is included in the outfit. This is equipped with two movable sliders, so that the plate voltage for V1 and the screen voltage for V2 may be adjusted to exactly the right values. If an available power pack already has a bleeder in it, it should be removed and the plus and minus leads brought up directly to the transmitter. A socket on the back of the chassis is the power connection. The filament and plate leads from the power pack are cabled together and connected to a plug that fits into

this socket.

The arrangement of the parts on the panel and chassis is very simple. The tuning condenser C1 and C2, the cathode resistor, the two jacks and a wafer type socket for the crystal are mounted on the front panel, while the tubes, the coils L1 and L2 and the various other small parts are on the sub-panel or rear deck. As both C1 and C2 are "hot" in relation to the grounded chassis, they are carefully insulated from the panel by means of large bakelite washers.

The small coupling coil on L2 leads to a pair of small porcelain stand-off insulators on the back edge of the chassis.

The plug-in coils are wound on receiving type forms, in accordance with the data given in the accompanying table.

All the parts for the Les-Tet Junior are available in complete kit form. An optional accessory is a neat cabinet.

All by itself, the Les-Tet Junior is a fine low-powered transmitter that will hold its own on the crowded ham channels. While maximum output is obtained on the crystal frequency, fine results are also had with the amplifier tube doubling and even quadrupling. With a 40-meter crystal, the writer has worked into the 10-meter band with a power output of 2 to 4 watts.

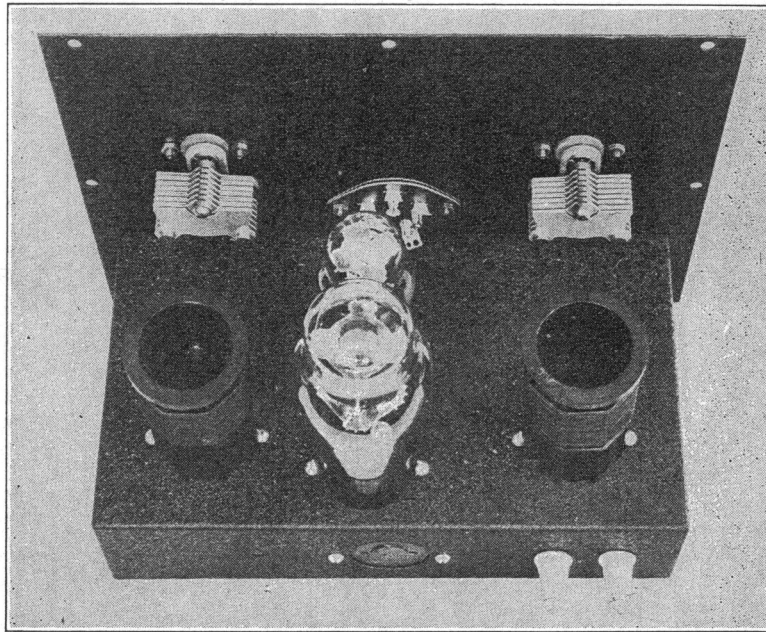

Back view of the Les-Tet Junior transmitter. The crystal plugs into the socket on the panel. C1 is on the right, C2 on the left.

|    | 20 METERS   | 40 METERS   | 80 METERS  |
|----|---|---|--|
| L1 | Same as 40 m. coil, no tap.   | 15 turns No. 18 DCC, 1/16-inch space. Tap, 5 turns up.                  | 24 turns No. 18 DCC close wound. Tap, 8 turns up.                  |
| L2 | 7 turns, No. 18 DCC, 1/8-inch space. Link coil, 4 turns, No. 22 DCC, close wound, 1/4 inch from cold end. | 15 turns No. 18 DCC, 1/16-inch space. Link coil, same as for 20 meters. | 24 turns No. 18 DCC close wound. Link coil, same as for 20 meters. |

## LES-TET JUNIOR COIL DATA

Four-prong forms, 1 5/8-inch outside diameter

Explanation: For 80-meter output use 80-meter crystal and 80-meter coils for L1 and L2, and neutralize tube V2. For 40-meter output with 80-meter crystal, use 80-meter L1 coil and 40-meter L2 coil. For 40-meter output with 40-meter crystal, use 40-meter coils for L1 and L2, and neutralize tube V2. For 20-meter output with 40-meter crystal, use 40-meter L1 coil and 20-meter L2 coil.

# Variable Condenser Breakdown Voltages

By RAYMOND L. MOREHOUSE\*

● There is an increasing tendency on the part of variable condenser purchasers, both professional and amateur, to demand condensers with certain voltage breakdown ratings. This has led to many mis-ratings, with the result that even experienced experimenters and amateurs are confused by the contradictory figures. The trouble is that most of these ratings are calculated on the basis of air separation between the plates, and many of them do not take into consideration such important factors as plate thickness and shape, operating frequency, and also the ratio of inductance to capacitance in the actual transmitter circuit.

In this connection, prospective users of high voltage transmitting condensers should be interested in the curves shown in Fig. 1. These represent the average of hundreds of individual tests made on stock condensers of various types and sizes by members of the writer's organization and also by independent testing laboratories. They reveal some pertinent facts that apply to all variable air condensers regardless of make.

All the tested condensers had polished plates with rounded edges. The use of square-edge plates in condensers intended for high-voltage applications is altogether unthinkable, as square-edge plates reduce the flashover voltage as much as 20 per cent. This figure is not a mere guess, but is based on actual measurements.

The curves are correct for plate thicknesses from about .025 to .062 inch. Thinner plates reduce the rating by 8 per cent or more, a fact that is not generally appreciated. Fig. 2 explains why this is so. The thinner the plate, the more nearly does it approach a sharp point, and, of course, corona and jumpover effects take place much more readily from points than from rounded surfaces. The comparative bluntness of plate B, as measured against plate A, reduces the sparking tendency considerably. The plate thicknesses have been exaggerated a little to show the general idea.

Design engineers will note that there is a 15 percent difference between the breakdown voltages of the same air gap when the condenser is used first on 515 KC and then on 4000 KC. The first frequency is regarded as average for the broadcast and neighboring channels, and the second for the amateur and high-frequency communication bands. No ordinary air dielectric condenser is ever used on 60 cycles, but the uppermost curve is included as a matter of interest, as it is often convenient to test the flashover voltage at that frequency.

Practical use of these curves is made in the following manner: Begin with the DC plate voltage of the tube, multiply by three, and from the chart pick a condenser with that flashover voltage, bearing in mind the approximate frequency the transmitter is to use. This procedure applies to circuits that are keyed for CW telegraphy. If the tube is plate modulated, use the multiplying factor four.

Split-stator condensers, which are commonly used in transmitting circuits, have a higher flashover voltage than the air gap alone indicates, as the sections usually are in series in relation to the applied DC voltages. In a series of measurements made on Cardwell condensers with air gaps from .07 to .218 inch, the flashover voltage for two sections was from 1.6 to 2.1 times that of one section alone.

The L-C ratio of the plate tuning circuit naturally must also be considered. The

higher the inductance, the greater the EMF developed across the circuit, and the greater the possibility of condenser flashover. This undoubtedly accounts of apparently adequate rating.

"Why worry about occasional flashovers in an air condenser, with its self-healing dielectric?" This question is frequently asked by amateurs and engineers without much practical operating experience with tube transmitters. The answer is found in the

behavior of a vacuum tube operated as an amplifier.

When the L-C circuit in the plate is tuned to the same frequency as that of the exciting source on the grid, the plate current assumes a comparatively low value, only 10 or 20 per cent of its full rated value. Off resonance, however, the plate current shoots up wildly. If the full rated plate voltage has been applied, the tube may readily lose all its emission, or the elements may collapse because of the terrific heat generated by the bombardment of the plate. Cases of tube failure due to careless tuning are quite common.

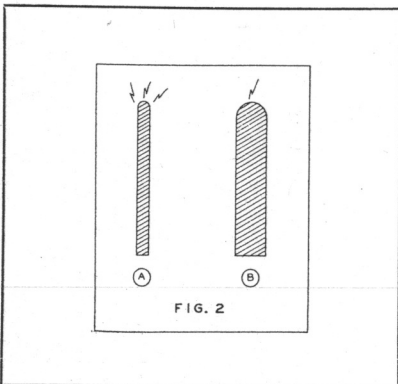
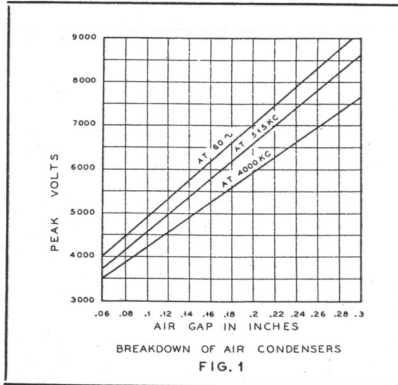

## CALLS HEARD

### Calls Heard at W3AAL

ON 14 MC  
X1AA, X1AI, X1AM, X1AX, X1AY, X1BB, X1W, X2C, EA1AM, EA1AV, EA3AA, EA3EG, EA4AO, EA4AP, EA4AV, EA4BM, EA8AH, EI2W, EI8E, EI8D, EI9F, CT1AA, CT2BD, CT2BK, CT3AB, PA0JAZ, PA0JRP, PA0JUU, PA0XG, OK1BC, HAF2D, HAF3D, ON4AU, ON4DS, ON4FE, ON4HC, ON4MAD, ON4SB, ON4SD, ON4UU, ON4ZA, G2DZ, G2BM, G2MI, G2MR, G2NH, G2OA, G2SX, G5BY, G5LA, G5GY, G6BS, G6JD, G6NJ, G6RB, G6RV, G6TK, G6XN, F8EX, F8KJ, F8LW, F8HF, F8PK, F8PZ, F8RQ, F8VT, F8WK, D4BAR, D4BU, D4BN, D4BIU, D4BMJ, D4BMR, D4BPJ, D4BSR, D4BWM, HC1FG, HC2MB, LU2PC, PY1IF, CX1CG, OA4AA, K5AC, K5AG, NY2AB, K4KD, VO2Z, LA1H, OZ2M, FM8BZ, FM8BG, VQ4CRL, CN8MP, VP4TF, VP2AT, VP2CD, FF8Q.

### Calls Heard by W9TB

G6XN, G6LK, 6VP, G6ZU, G6RV\*, G6UF\*, G6NF\*, D4CAF, D4BAR, D4BIU, D4BUK, D4BUF, D4BBN, D4BKK, D4BVR, D4BFN, D4BPJ\*, D4BDR\*, D4BKH\*, ON4UU, ON4ZA, ON4AU, ON4RX, ON4MX, ON4UF, ON4SD, ON4FE, ON4HM\*, ON4DS\*, F8EX, F8RQ, F8PZ, F8FC, F8WB, F8VP, F8VJ, F8TQ, F8AL, F8AR\*, F8SQ\*, F8DT\*, F8BT\*, F8AD\*, LU1EP, LU1CH\*, LU4DQ\*, LU5AP\*, LU6JB, LU6DJK\*, LU8DJ\*, LU9BV\*, PY1AW, PY1IK\*, PY1DW\*, PY1IF\*, PY2CD, PY2BX, PY2BU, PY2BB\*, PY2KK\*, PY5AG\*, PY1IW\*, EA1AM, EA1AV\*, EA3EG\*, EA3EG\*, EA4AV, EA4BM, EA4AO, EA4AP\*, EA8AH\*, FM8BG, CM2JM, CM2FA, CM2WD\*, CM8AF, K5AC, OA4J, OA4AA\*, OH3NF, E16F, E18E, OK2AK, OK2RM, OK1AW\*, VQ4CRO, VQ4CRP, GI6TK, GI5QX, GI6YW, LAIG, LA4B, SM5YS, OZ2M, LY1J, OE1ER, OE3FL, OE7EJ, OE7JH\*, HJ3ABK\*, VO1N, VO4Y\*, ZD2C, ZT1R, VP5AB, VP5JB\*, SP2A\*, VP7NB\*, K4AAN.

## A CORRECTION

LAW OFFICES  
PRENDERGAST, FLANNERY & YOUNG  
Minneapolis, Minnesota

CORRECTION

May 20, 1935.

Mr. H. W. Dickow,  
Editor of "RADIO",  
Pacific Building,  
San Francisco, California.

Dear Mr. Dickow:

I am sorry that my telegram pointing out an unintentional misquotation in my Des Moines speech reached you too late to allow its correction before the May "RADIO" was printed. The error was mine, not yours, and I wish to straighten it out.

Warner's estimate was that there were 35,000 individuals in this country holding amateur radio operators' licenses, as distinguished from station licenses. He did not say that all of these 35,000 were active. He put the figure at 28,000, not 35,000, when he estimated the number of active licensed amateurs in the United States.

However, the figures given by the League to support the finding that 67.76% of the League's U. S. A. members are licensed "Hams", draw no distinctions between active and non-active licensed amateurs.

It is just as true as ever, that the data quoted in my Des Moines speech shows one licensed U. S. A. "Ham" in the League, and two licensed U. S. A. "Hams" out of it, on the date of that "census", if Warner's estimate was correct.

If the League actually discovered, on checking the F. C. C. records, exactly how many individuals then held "Ham" operators' licenses in the United States, it hasn't disclosed this figure. If it were published, it would show whether or not Warner's estimate of 35,000 licensed operators was correct.

My own guess is, that there were many more than 35,000 on the date selected, and that the actual figure is known in West Hartford, and has been intentionally suppressed.

Very truly,

SBY-S

(Signed) SUMNER B. YOUNG.

\* Engineer, the Allen Cardwell Mfg. Corporation.

# The Bias-Shift Class A Amplifier

## -and Its Applications To Controlled Carrier Modulation

By J. N. A. HAWKINS\*

● The operating bias point for the conventional class A amplifier is largely dictated by the available plate dissipation of the tube used; the bias must be chosen so that the normal plate input will not cause excessive plate heating when no signal is applied to the grid. This fact also limits the plate voltage that may be used with a class A amplifier. This disadvantage is avoided in class AB and class B audio amplifiers because they operate with somewhat more than normal class A bias, so that the no-signal DC plate input drops to quite low values. However, this necessitates the use of the push-pull circuit in order to minimize the effect of the serious even harmonic distortion generated in tubes operating class AB or class B. This distortion is caused by the fact that the instantaneous grid excursions swing out beyond cut-off on the most negative half of the cycle.

The bias shift class A amplifier is normally biased close to cut-off in the resting, or no-signal condition. This keeps the resting plate current down to a low value and prevents excessive plate loss in the resting condition. As soon as an audio signal comes along it is rectified and applied to the bias supply of the amplifier with the polarity of the rectified AC chosen so that it reduces the normal high resting bias. This shifts the bias axis of the amplifier to the right and prevents the negative grid excursions from, or even approaching the cut-off point. The louder the audio signal, the more the bias axis shifts to the right and the lower the average tube impedance becomes, which increases the linearity and plate efficiency of the amplifier. This reduction in average plate impedance is also quite useful in effecting syllabic carrier control in a series-modulated phone transmitter.

The bias shift circuit is filtered so that only the syllabic components below 20 cycles per second are used to reduce the DC negative grid bias. Thus no extraneous modulation frequencies are generated, and the output wave shapes are good replicas of the input wave shapes. This amplifier is truly class A in operation because plate current flows for 360 electrical degrees; in other words, throughout the cycle.

The circuit of the amplifier and its associated bias control tube is shown in Fig. 1.

The normal resting bias is determined by the relative resistance and voltage drops across R1 and R3 which are in series across the bias supply. R2 acts as a cathode bias resistor for the control tube T2 and is chosen large enough so that T2 is practically at cut-off when no audio signal is present; in other words, T2 operates like a biased detector. When an audio signal appears across the secondary of the input transformer and is applied to the grid of the amplifier tube, it is also applied to the grid of the bias control tube. This signal lowers the resistance of the plate to cathode path of the control tube T2 which is in parallel with the high resistance R1. The flow of current through the control tube causes the voltage drop measured across R1 to decrease and the drop across R3 to increase, which lowers the bias on the amplifier tube T1. This shifts the bias axis of the amplifier from the region near cut-off to a point farther up on the straight portion of the characteristic. (See Figs. 2 and 3). The amount of bias shift depends on the AVERAGE amplitude of the audio signal, which corresponds

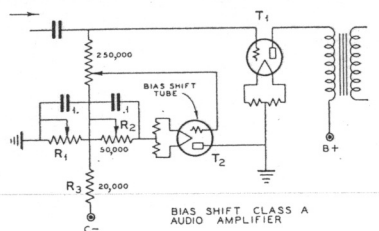

FIG. 1

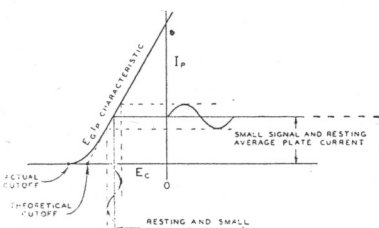

FIG. 2. Operation with zero, or small signal.

closely to the syllabic amplitude. Thus a syllabic shift in the amplifier bias allows it to operate at a considerably higher value of effective plate efficiency. In general, any given audio tube is capable of approximately twice its normal class A output when used as a bias shift amplifier. Of course, a somewhat higher plate voltage is necessary to realize the full advantages of bias shift amplification.

### Applying the Bias Shift Class A Modulator To a Controlled Carrier Phone Transmitter

The bias shift class A audio amplifier is ideally suited for use as a plate modulator in a controlled carrier transmitter because when connected in the conventional series modulation circuit it combines the functions of the audio and syllabic modulators.

Fig. 4 shows the circuit diagram of a plate modulated class C RF amplifier whose carrier output is subjected to syllabic control. Series modulation is used for both the audio modulation and the syllabic control modulation. One of the advantages of series modulation

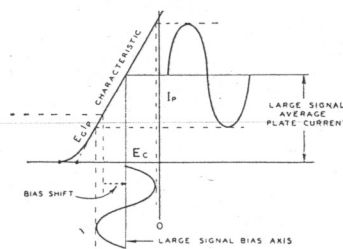

FIG. 3. Operation with large signal.

is that no modulation choke or output transformer is necessary. In order to obtain 100% modulation capability it is necessary to provide a DC dropping resistor R4 somewhere in the plate circuit, with an AC audio by-pass condenser connected across it. The values for the dropping resistor and its associated by-pass condenser are chosen by the same rules that determine the values of dropping resistor and by-pass in the conventional choke coupled Heising modulation circuit. The dropping resistor is chosen so that the peak AC voltage output from the modulator, (at maximum audio signal), exactly equals the DC voltage drop between plate and filament of the class C stage. Only when this is done can 100% modulation capability be achieved. If the dropping resistor were not by-passed by C4 (one to four mikes) the audio voltage would be dropped, as well as the DC, and nothing is accomplished. The larger the value of R4, the smaller can be C4, for a given amount of audio fidelity (low frequency response).

The class C amplifier is entirely normal except that it should be remembered that it is all above ground to DC and audio volt-

(Continued on page 28)

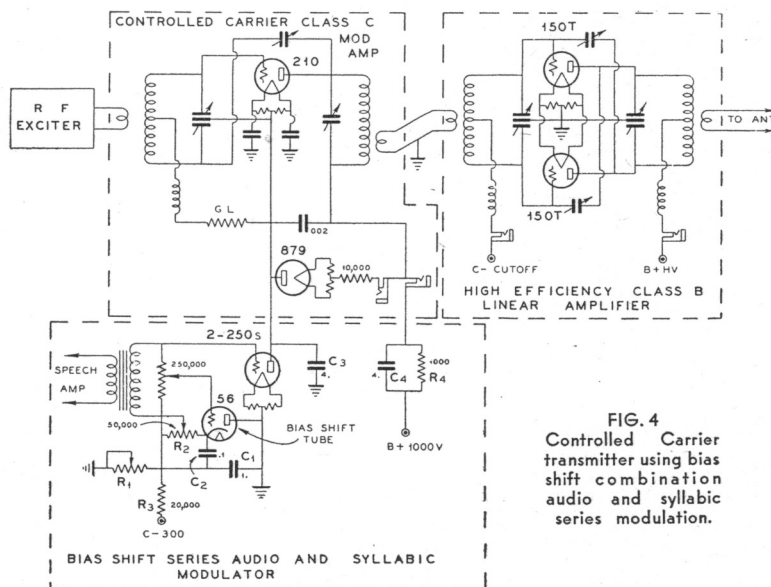

FIG. 4  
Controlled Carrier transmitter using bias shift combination audio and syllabic series modulation.

\* W6AAR.

# An Outstanding Amateur Station

**A**MATEUR Radio Station W6ITH, owned and operated by D. Reginald Tibbetts, 750 Spruce street, Berkeley, California, is considered by many to be one of the finest amateur stations on the Pacific Coast, if not in the entire country.

Since Tibbetts is a 'phone man exclusively, all the equipment illustrated is operated on five amateur 'phone bands. Separate transmitters, each complete in themselves and all capable of going on the air simultaneously, are provided.

All the equipment shown except the Collins 7C Speech Amplifier and the three Collins Rectifier Housings were constructed by Tibbetts in his own laboratory. The panels are all  $\frac{3}{8}$ -in. aluminum, being standard multiples of  $1\frac{3}{4}$ -in. The panels are all 19-in. wide and are mounted in standard 36-unit telephone relay racks. The racks were fabricated, drilled, tapped, welded and painted in the laboratory. All panels are painted with crackle.

The first rack on the right contains three transmitters, for the two and one-half, five and ten meter bands. The two and one-half meter transmitter, operating on a frequency of 112,000 KC, uses a single 6A6 in TNT push-pull as modulated oscillator, being modulated by a single 6A6 in class B. The class B stage is driven by a third 6A6 used as triode driver. The driver grids are swung by a single-button Western Electric Type 395B microphone. The antenna used with this transmitter is a half-wave vertical rod on top of the house, the antenna and transmitter being connected by a vertical rod 500 ohm matched impedance transmission line. The  $2\frac{1}{2}$  meter equipment is found on the top panel, together with the receiver used on the same band. The receiver speaker is clearly shown in the center of this panel. The  $2\frac{1}{2}$  meter receiver consists of a 58 radio-frequency stage, 56 grid leak super-regenerative detector, which is in turn transformer coupled into a single 2A5 pentode driving the 5-in. dynamic loudspeaker. One side of the transmitting antenna is used for receiving. The input power to the transmitter is 25 watts.

Just below the blank strip, the 10 meter transmitter is found, together with its receiver. A 6A6 TNT push-pull oscillator is used to drive a pair of 2A3s in a class C push-pull modulated amplifier. The modulator consists of a pair of 46s in class B, a 46 triode driver and 57 speech. The microphone is a Western Electric Type 600A, double button. The receiver consists of a 6D6 radio-frequency stage, 6D6 detector, transformer coupled to a single 2A5 pentode driving another 5-in. dynamic speaker shown on the left side of the panel. The receiver can be used as either autodyne or super-regenerative. Tuning on this transmitter is fixed at 14,170 KC and only the receiver dial is required. The antenna system consists of a half-wave vertical brass rod, also on top of the house, fed with a 500 ohm transmission line of matched impedance type. The ungrounded side of the transmission line is connected to the grid of the radio-frequency stage and serves as the receiving connection. The output to the transmitter is 35 watts.

Below the 10 meter equipment the repeater and bridging panel is found. This panel contains equipment for connecting any receiver and any transmitter to a single remote control line and prevents a received signal on a duplex transmission from feeding back into the transmitter; at the same time it allows signals from the line to modulate the transmitter.

At the top of the second rack from the left

one sees the 5 meter transmitter. This transmitter consists of a pair of Western Electric 304As in TNT push-pull, modulated by four 10s in push-pull parallel class B. The power input is 250 watts and the operating frequency is 56,100 KC. Just below this transmitter are three 5-in. dynamic loud speakers, used in connection with the four receivers found just below. The four receivers have, between them, continuous handspread from two to eleven meters. Combined volume and regeneration controls are located below each receiver dial. The generous use of these various receivers allows several duplex and triplex transmissions and remote control operations in the ultra-high frequencies.

Next following down on this rack is the patching and bridging panel. All speech cir-

The antenna used with this 160 meter 'phone is a full wave, pointing north and south, being fed at one end through a "pi" section network, the controls for which can be seen on the top panel. All stages, plate and grid, are metered as can be noted from inspection of the photograph. The generous use of meters assures proper and rated operation at all times.

The fourth rack from the left contains all speech equipment for both the 75 and 160 meter transmitters. The main speech amplifier is a Collins 7C, high fidelity, being flat within one DB between 35 and 12,000 cycles. This amplifier is fed directly from a crystal microphone and the output swings the grids of the modulators of either or both the 75 and 160 meter transmitters. The tube com-

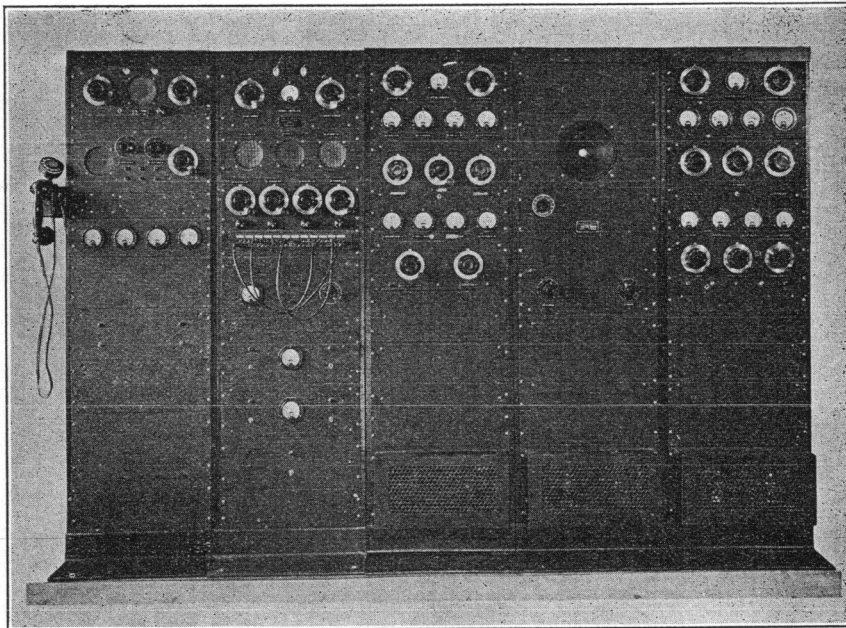

Here is D. Reginald Tibbetts' super-amateur station, unquestionably one of the finest in the world. Tibbetts' occupation is Chief Engineer of the San Francisco-Oakland Bay Bridge Construction Radiotelephone System, which he and Frank C. Jones of "RADIO" engineered.

uits in all the equipment terminate and feed through this point. Through patching jacks are provided, and under normal operation no plugs need be inserted. The plugged cords are used to secure access to any speech circuit and in this manner the utmost in flexibility is afforded.

Below the patching and bridging panel is the 5 meter speech and modulator. The modulator has been mentioned and the speech consists of a 53 triode, driving another 53 in push-pull which, in turn, swings the grids of a pair of 2A3s in push-pull class A.

The power supplies for all the equipment on this rack are found below, there being three supplies using 866s and 83s as mercury vapor rectifiers.

The third rack contains the complete 160 meter 'phone transmitter operating on either 1951.5 or 1996 KC. The tube line-up is a 47 crystal oscillator using AT cut crystals in an oven. The next stage is an 865 screen-grid buffer which excites a pair of 10s in push-pull class C plate modulated amplifier. The modulator is a pair of 10s in class B. The modulators are driven by the Collins 7C high fidelity speech amplifier, which is described under the 75 meter 'phone transmitter.

pliment of the amplifier is a 57 voltage amplifier, resistance coupled into a 56 which, in turn, is transformer coupled into another 56. The second 56 is transformer coupled into a pair of 2A3s in class A push-pull. The overall gain is 134 DB and the undistorted output is seven watts.

A 10-in. dynamic speaker is shown directly above the Collins amplifier. This speaker is used for general purposes, being connected into the patching jack panel. A bridging and general purpose amplifier is inserted just below the main speech amplifier. This amplifier is used for remote control operations and for other bridging purposes. The response of this amplifier is also of high fidelity and is provided with optional equalization to compensate for line irregularities.

Next on this rack comes the modulator for the 75 meter transmitter. This modulator consists of a pair of carbon plate 203As in class B push-pull, giving a power output of 300 watts. The output system is novel, inasmuch as the output transformer and shunt feeding choke are wound on the same core, giving a high value of inductance and self-protection to the output transformer in case

(Continued on page 80)

# FIESTA!

● **Fiesta!** A word symbolic of joy at peak voltage in Sunny California on the border of old Mexico. Ham doin's mixed with charming señoritas, technical radio, nudists, the world's believe-it-or-nots, people of all nations, cities of magic, a man-made flaming aurora borealis, old world atmosphere, architectural splendor, magnificent palaces, modern marvels 'neath tropic skies. That's a kaleidoscopic picture of the gigantic Radio Fiesta scheduled for July 20 and 21 in the heart of the world's greatest Exposition, Balboa Park, San Diego, California.

Never has hamdom been so blessed as in this forthcoming event. Along with admirals, cabinet members, ambassadors, and high government officials, Exposition officials have joined with the San Diego Radio Amateurs Association in extending cordial welcome to the brass-pounders of the nation to stage their ham fiesta at the California Pacific International Exposition. Situated in magnificent Balboa Park, which encompasses 1400 acres of nature's best efforts, the visitor may see to the west the unlimited expanse of the blue Pacific, where ride at anchor Uncle Sam's battle-wagons, and to the south, the mountains of old Mexico, a foreign land. A spot thrice-blessed—the scene of the year's biggest amateur convention.

One thousand dollars worth of prizes! At least, one grand of iron dollars is being spent by the San Diego ham population for an array of radio prizes such as never been seen at a similar occasion. Setting a minimum of carbon plate 210 bottle or its equivalent as the lowest prize, the local gang have made positive that the prize you carry home to your shack will be worth-while. Unique in ham history is the fact that this fiesta will not stage a raffle. Everyone attending has an equal chance at the fine equipment offered. All prizes except those awarded for the many contests will be door-prizes. Your ticket entitles you to your share of the booty. The local hams anticipate no fiesta profits and are putting every dime into rewards for those that attend. At least one thousand amateurs are expected. Hams from all over the western United States have signified their intention of being on deck for the big celebration. The more attendance—the more prizes—there is no upper limit. Big prizes such as the Breting Super and the PR12, new outstanding receivers will go home with some lucky ether-disturber.

Contests galore are on the schedule, many new and different. Instead of the usual code speed contest this feature will consist of a QRM readability test. Several different stations will be fed into the PA system along with a little broadcast QRM for good measure. The contestant must copy a certain station through this interference.

Ambitious YLs and XYLs with melodious voices will be given a chance for competition in the Mike Audition. Again the contest varies from the usual in that it will be for ladies only and judged by a real expert, i.e., Gary Breckner, well known CBS radio announcer and KGB station executive, who, by the way, is also Master of Ceremonies for the ham festivities. Attending females will get their opportunity for competition in this contest and will be chosen, we imagine, for the "sweetest voice". A special women's prize to the winner of this classic.

Contributing to ham progress in emergency communication is the big portable contest. Every ham who can possibly do so is requested to bring some kind of portable on the bands he chooses incorporating his own ideas. These will be judged for design,

workmanship, appearance and originality. It is expected that this contest will evolve some real progress in emergency and mobile communication. This is in line with the thought that every ham should be properly equipped for communication in times of local or national emergency. Both DC and "pansy" (AC) types of portables are welcomed.

Other contests include a Tug of War, Phone vs. CW hams, a hidden 56 transmitter hunt, a prize to the ham coming from the greatest distance, and many other contests that the fertile minds of the Fiesta committee will evolve in the interim.

Trips include a visit to the giant Navy radio station NPL, both the transmitters in

The women folk of visiting hams who see "no sense" in radio shop talk will find a tending circus in the wonders of the Expo. Mrs. W6FQU will serve as hostess. Hams, when not lying about their DX, may visit the City of Midgets, the Hollywood Hall of Fame, where movies are actually being made and projected. The Bell Tel. & Tel. Exhibit (of great technical worth), the two-million-dollar Ford building, the various palaces of Science, Art, Transportation, Photography, etc., Gold Gulch, with the Days of '49 completely reproduced with gold panning, sluicing, the open saloon and the stage coach. The Midway offers both the usual and unusual carnival attractions. Among the unusual is the



This gang worked three days making a transmitting and reception survey in connection with the Radio Amateur Fiesta, July 20, 21.

Chollas Heights and the receiving station at Point Loma ("where at the same time you may take in the world's second best scenic view), harbor trips to ships and navy vessels, radio inspection of military radio at North Island where is situated the Navy's largest flying field and the famed Rockwell Field of the Army; trip to a local brewery (with samples), journey to old Mexico to Agua Caliente and Tijuana, fishing trips, local broadcasting stations and other attractions.

This year's W6USA official ham station of the Exposition affords tremendous interest; a powerful one kilowatt rig of no mean proportions offering amateurs an opportunity to pound the key or use the mike attached thereto. Other transmitters will also be on exhibition. Portable operation will take place before the thousands of visitors to the Expo and offers hamdom a real chance for the publicity it needs.

Railroads, shiplines, and bus companies are joining with San Diego hotels in making rates the lowest possible for those who attend the Fiesta. This offers the amateur a chance to see this colossal Exposition, attend the big Radio Fiesta, enjoy your whole vacation, for that matter, all in one. A triple treat. Northern California hams might well combine a sea voyage via a palatial coastwise ship at low rates to San Diego. Those who wish to spend a whole vacation in this climatic capital of the world may do so and be assured that hams will keep things moving for them during their entire stay.

Nudist Colony labeled Elysian Gardens\*. The sensations comprise a glorified girl show with twenty of the world's beauties, combined with stage effects accomplished by refraction of light.

The exact schedule for the two-day events are:

## SATURDAY, JULY 20

9:00 a.m.—Beginning registration.  
12:00 to 2:00 p.m.—Inspection trip to ABC Brewery. Retire to Exposition.  
3:00 to 5:00—Ultra-high frequency equipment contest in Exposition grounds.  
5:00 to 10 p.m.—Visit Exposition exhibits. Technical talks in House of Hospitality. Visit W6USA.

## SUNDAY, JULY 21

9:00 a.m. to 1:00 p.m.—Agua Caliente, Rockwell Field, Naval Air Station, NPL receiving and transmitting stations, Naval vessels.  
2:00 p.m. to 5:00 p.m.—Novelty code contest. Tug of War—Phone vs. CW. Ladies' Audition contest.  
6:30 p.m.—Meet at pier—Foot of Broadway.  
7:00 p.m. to 11:00 p.m.—Banquet, speakers, drawing of door prizes, delivery of contest prizes.

Tickets for the two-day celebration are \$3, and include everything, such as two tickets (one each day) to the Exposition, the banquet, other eats, etc. There will be a \$2 ticket, and will include one ticket to the Exposition, a chance in contest and banquet only (this ticket will not give you a chance at the door prizes).

Request for reservation tickets and other information should be addressed to the San Diego Radio Amateurs Association, 2340 University Ave., San Diego, California.

\* The Nudist Colony has been fenced-in (no knock-holes) but a view can still be had from the roof of a near-by building.—Ed.

## BUFFER STAGES FOR THE JONES EXCITER

The Jones all-band exciter uses a type 53 (or 6A6) tube as the oscillator-frequency multiplier to drive a 2A3 or a 45 tube in the buffer stage. Other tubes can be used in the buffer stage, if desired. The following tubes and the method of coupling to the exciter stage will give entirely satisfactory results:

Any of the above combinations will provide sufficient excitation for one or two type 211 tubes, or for two 50Ts, or a single 150T or HK354, for grid modulation. If CW is to be used, with very high power input to the final stage, it is desirable to use an additional buffer stage. If two 211s are used in the final amplifier, they should be driven by a pair of 210s or 801s, operating with a plate voltage of at least 700 volts. If, however, a

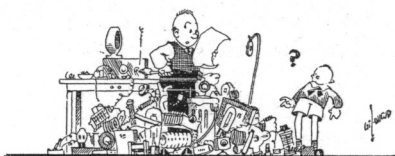

## Ham Hints

— By JAYENAY —

10% of the normal maximum plate current allowable with the type of tube used. Copper tubing tank coils are often responsible for an unnecessarily high minimum plate current. A great deal of metal in the inductive field of the plate tank coil also causes

|                                       |                                    |
|---------------------------------------|------------------------------------|
| Single 45 or 2A3.....                 | Capacitive coupling                |
| Single 46 .....                       | Link coupling                      |
| Single 841 .....                      | Link coupling                      |
| Single 210 .....                      | Link coupling                      |
| Single 801 .....                      | Link coupling                      |
| Single 865 .....                      | Either capacitive or link coupling |
| Single 53 Push-Push Doubler.....      | Link coupling                      |
| Single 59 Regenerative Doubler.....   | Capacitive coupling                |
| Two 45s in Parallel or Push-Pull..... | Either capacitive or link coupling |
| Single 802 .....                      | Capacitive coupling                |

50T, 150T or HK354 is used in the final, a single 210 or 801, at 700 volts will give sufficient drive for CW.

### Adjusting the Exciter

The 53 exciter stage should not be tuned too close to the point at which it stops oscillating, if more than 350 volts is used on the plate, otherwise the tube will run wild. The oscillator section should be tuned to the approximate mid-point of its oscillating range. The doubler section should be tuned to peak output. When the oscillator is not oscillating, the cathode current will read only about 20 mills; when oscillating, the cathode current will range from 60 to 110 mills. Determine the oscillator adjustments with the aid of a neon glow lamp, or with a flashlight bulb and a single-turn loop.

### Grid-Leak Values for the Loop-Modulated 5-Meter Phone

The single-tube 5 meter phone described in March "RADIO" can sometimes be made to operate better as a receiver when a higher value of grid-leak is used, such as 50,000 ohms, instead of 15,000 ohms, as originally specified. The value of this grid-leak depends on the amount of antenna coupling and microphone loop coupling, also on the arrangement of the parts in the set.

### Minimum Plate Current

The best way to measure the losses in a tank circuit is to remove the load, which may consist of an antenna or another radio-frequency amplifier. When the load is removed the plate current should dip to a value that is not more than about 10% of the normal operating plate current. This minimum value of plate current indicates the amount required to overcome the resistance losses in the plate tank circuit. A high minimum plate current may indicate insufficient excitation or bias. However, it usually indicates excessive losses in the plate tank circuit. These losses may be due to high radio-frequency resistance in the tank coil and sometimes they are due to a high resistance rotor contact in the plate tank condenser. It is absolutely impossible to obtain high plate efficiency from an amplifier stage whose minimum plate current exceeds

losses. Sometimes the use of poor insulation in the plate tank condenser causes a high minimum plate current. If any part of the tank condenser or tank coil becomes hot to the touch (with the load disconnected) it is an indication of excessive losses. The ideal tank circuit consists of a low C tank coil made from No. 10 wire and supported by celluloid strips, and mounted as far away from metal chassis or breadboards as possible. The leads should be short and direct, and all leads should be soldered. The diameter of the coil should be approximately equal to its length. If a push-pull stage is used, care should be taken to make all leads as symmetrical as possible with respect to ground.

### Power Gain or High Efficiency—Which?

Power gain indicates the ratio of output as against input grid driving power. This indicates the power amplification of any stage. High plate efficiency is important because it enables high power output to be obtained from relatively small tubes. These two characteristics rarely go hand in hand. High plate efficiency requires high bias and high excitation. In the case of an 852 it is often necessary to bias the tube to 4 times cut-off, and to excite it to 60 mills of grid current. Under these conditions it may take 150 watts of grid driving power to obtain 450 watts of output. This represents a power gain of 3.

For maximum power gain (considering plate efficiency as a secondary characteristic) it is desirable to bias the tube to approximately class B, or cut-off. Under these conditions the plate efficiency is usually around 66%, in the case of the 852, which means that 200 watts of output is about all that one can expect. However, in order to get this 200 watts of output, only about 20 watts of excitation is required, which represents a power gain of 10. The ideal tube would enable high power gain to be obtained simultaneously with high plate efficiency. The best yardstick of efficient power gain is transconductance. In other words, the tube with the highest transconductance gives the greatest power gain for a given plate efficiency. Expressing this in another way, the tube with the highest transconductance gives

the greatest plate efficiency at a given power gain.

Incidentally, the pentode is a wonderful example of this compromise. It gives very high power gain at plate efficiencies below about 66%, but above 66% plate efficiency it usually requires somewhat more grid drive than a modern, well-designed triode.

### The RK-100

The Raytheon RK-100 represents the latest amateur contribution to the field of radio communication, being a development of W1GBE, who is well known among the high power phone amateurs. This tube consists of a very special type of thyratron which is unusual in that the grid can stop as well as start the flow of plate current. As a matter of fact, the grid controls the plate current just as it does in any high vacuum triode. Because the space charge is partially neutralized by the presence of positive mercury vapor ions, the plate resistance is exceptionally low. This allows relatively high power output to be obtained at low plate voltages. Although the tube is a triode it has four elements, not counting the heater. The heater voltage is 6.3 volts at .6 amperes. There is a regular cathode in the tube, plus a cathanode which is maintained at a potential between 14 and 18 volts positive with respect to the cathode. The mercury vapor discharge occurs in the space between the cathode and the cathanode. The cathanode becomes the virtual cathode and very little ionization occurs in the space between the cathanode and the plate, due to exceptionally close mechanical spacing. This fact, combined with the very fine mesh of the control grid, enables the control grid to maintain control over the plate current, even though there is ionization present. The principal difference between this tube and a mercury vapor rectifier is that the space charge is entirely neutralized in the rectifier, while it is only partially neutralized in the RK-100. The main use for this tube will probably be in the audio output power stage in broadcast receivers. It makes a good oscillator or doubler for amateur use, due to its high transconductance.

### Plug On Tube Base Plugs Patent Leak

It is reported that the new 8-pin base (for the metal tubes) with its centering plug is patented, which probably means that the independents cannot manufacture glass tubes with bases to fit the new RCA octal socket, unless a royalty is paid.

Amateurs need have no fear that the present glass transmitting tubes will be replaced with all-metal tubes.

### New High-Frequency Receiver

● Frank C. Jones has developed a new amateur receiver, to be called "The 40-20", because it covers only the 20 and 40 meter bands. However, coil data will be published showing how to adapt the receiver to other amateur bands. This new receiver has many novel features. It uses a crystal filter, separate tuning dial for both bands, and a novel arrangement to change from 40 to 20, and vice-versa. The coils are permanently fixed in place . . . neither plug-in nor coil-switching methods are used. Special coils have been designed for each band. For the amateur who wants the utmost in performance on 20 or 40 meters this receiver will be ideal. Also in July "RADIO" will be found a high-power grid-bias-modulated phone by Jones. The "Hall of Fame" amateur receiver which was scheduled for this (June) issue has been held up until next month.



# EIMAC Tubes—More Power, Less Cost

"EIMACS Are Doing a Great Job" . . . Says W5CCB

•••

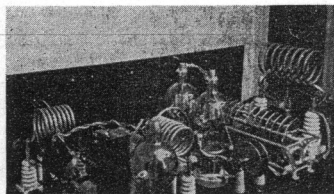

## W5CCB World-Famous 14MC Phone Station

W5CCB, Fred Mason of Tulsa, Oklahoma, is for high power—first, last and always. However, he believes in simplicity and economy in obtaining high power. The c.w. portion of his 1 KW phone uses only three stages—an RK20 working out of a 20 meter crystal, an EIMAC 50T buffer and push-pull EIMAC 150Ts in the final amplifier. Link coupling is used throughout. This is just about the simplest 1 KW transmitter that we have encountered. The last two stages use the same power supply, thus making for greater economy. This station is one of the few phone WAC stations in North America. W5CCB refuses to divulge the number of countries he has worked because he is engaged in a friendly contest with W9BHT, Bill Ingersoll of Canton, Illinois (another WAC on phone, as well as an EIMAC user), to see who can work the greatest number of countries on phone. It might be pointed out that W5CCB obtained his phone WAC without using cw to raise the foreign stations. Everybody he has worked was called on phone. In all fairness it must be emphasized that W5CCB installed his EIMAC Tubes since he obtained his WAC on phone, and thus we can take no part of the credit for having helped him in this achievement. However, we are proud of the fact that when he rebuilt his transmitter just recently, he chose EIMAC Tubes in preference to any others on the market.

★ ★ ★ ★ ★

## DIATHERMY

The most gruelling test for any transmitting tube is its use in the new Diathermy fever machines which utilize high-frequency r.f. current to generate internal heat in the body of a patient due to dielectric loss. The higher the frequency the harder it is on the tubes, and the fact that EIMAC Tubes are being widely used in the newer 6-meter Diathermy oscillators is indicative of the superiority of EIMAC design and construction. Amateurs the world over are beginning to appreciate the desirability of the exceptional performance and ruggedness characteristic of all EIMAC products. The use of Tantalum as a plate and grid material was pioneered by the engineers who head the EIMAC organization. The use of Tantalum and the elimination of the gassy materials formerly used has made possible an entirely new kind of tube performance.

No. 3  
of a  
Series  
of 12

## Your Problems—and Their Solution High Efficiency—

BY high efficiency is meant high plate efficiency. High plate efficiency is desirable because it enables high power output to be obtained from small, low-cost tubes. The cost of a vacuum tube does not depend on the power which can be obtained from it, but mainly on the amount of heat it can dissipate from its plate. If only 25% of the total DC input must be dissipated in the form of heat (75% plate efficiency), a much smaller tube can be used to obtain high power output than if one-half of the total input is dissipated in the form of heat (50% plate efficiency). It is well to remember that the total power input to any final amplifier stage is divided between the load (usually the antenna) and the plate loss in the tube itself. Thus it is essential that the highest possible percentage of the total input be transferred to the load, leaving only a small amount of power to be dissipated from the plate of the tube in the form of heat.

### HOW TO OBTAIN HIGH PLATE EFFICIENCY

HIGH plate efficiency is obtained by making the ratio of load impedance to tube impedance as high as possible. Thus in order to raise the plate efficiency either the load impedance can be increased, or the tube impedance can be decreased. The load impedance is raised by using loose coupling to the load. In order to realize the benefits of loose coupling, the inherent losses in the plate tank circuit must be kept at a minimum by using high "L", low "C", good insulation and low-loss tank coils. The use of a high load impedance also requires an increase in the plate voltage above the amount needed when a low impedance load (tight coupling) is used.

The internal tube impedance is reduced by increasing the grid excitation voltage. When the excitation is increased it is also usually necessary and desirable to increase the negative grid bias.

It should be emphasized that the required grid driving power goes up faster than the increase in power output, so that raising the plate efficiency of an amplifier stage always reduces the power gain through that stage.

### ECONOMICAL . . . HIGH EFFICIENCY DEPENDS ON THE TUBE USED

MOST transmitting tubes are designed for commercial use in circuits where 50% plate efficiency is normal. This means that the plate voltage and plate current limitations are chosen so that the maximum allowable DC plate input amounts to between two and three times the available plate dissipation of that tube. Thus only a few of the benefits of high plate efficiency can be realized with conventional tubes because the maximum allowable plate input is limited. On the other hand, EIMAC Tubes were designed with high efficiency in mind and all EIMAC Tubes can be operated with plate inputs in excess of four times the rated plate dissipation without exceeding plate voltage or plate current ratings. In order to utilize this advantage it is, of course, necessary to design the amplifier so that it will operate at high plate efficiency. High plate efficiency can be obtained at lower plate voltages when using EIMAC Tubes than when conventional tubes are used. This is because the low internal plate impedance of the EIMAC 50T and the EIMAC 150T enables a large ratio of tube impedance to load impedance to be obtained without using excessively high load impedances and plate voltages. The high transconductance of all EIMAC Tubes enables this low dynamic tube impedance to be obtained with an exceptionally small amount of grid driving power. This means that, for a given plate efficiency, materially more power gain can be obtained by using EIMAC Tubes. Another point—it is rarely necessary to use more than twice cut-off bias with EIMAC Tubes, which reduces the r.f. exciting power wasted in the bias supply. The ideal tube for high plate efficiency and power output must have low plate resistance, high transconductance, high-voltage plate and grid insulation, low gas content (high vacuum) and very high filament emission . . . . .

. . . . . IN OTHER WORDS, EIMAC!

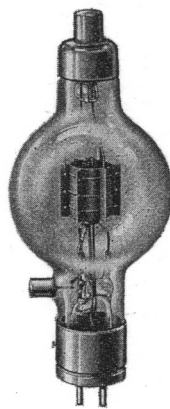

EIMAC 50T  
Net - - - \$13.50

## Compare and Reflect CONSERVATIVE RATINGS

50T

50 Watts of Available  
Plate Dissipation . . .  
30 Watts of Filament  
Heating Power!

CHARACTERISTICS  
Fil. Voltage 5V; Fil. Current  
6A; Rated Plate Dissipation  
50W; Amp. Factor 13; Max.  
Plate Current 100MA. Plate  
Voltage 1000 - Power Output  
75W. Plate Voltage 2000 -  
Power Output 150W. Plate  
Voltage 3000 - Power Output  
250W.

150T

150 Watts of Available  
Plate Dissipation . . .  
50 Watts of Filament  
Heating Power!

CHARACTERISTICS  
Fil. Voltage 5V; Fil. Current  
10A; Rated Plate Dissipation  
150W; Amp. Factor 13; Max.  
Plate Current 200MA. Plate  
Voltage 1000 - Power Output  
150W. Plate Voltage 2000 -  
Power Output 300W; Plate  
Voltage 3000 - Power Output  
450W.

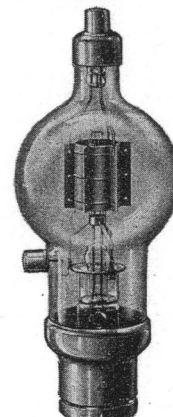

EIMAC 150T  
Net - - - \$24.50

## EITEL-McGULLOUGH, INC.

SAN BRUNO, CALIFORNIA, U. S. A.

Albany, N. Y.  
Uncle Dave  
Atlanta, Georgia.  
Wholesale Radio.  
Baltimore, Maryland.  
Radio Electric Svc.  
Boston, Mass.  
The Radio Shack.  
Buffalo, N. Y.  
Dymac Radio  
Butler, Missouri.  
Henry Radio Shop.  
Chicago, Illinois.  
Allied Radio Corp.  
Midwest Radio Mart.  
Newark Electric Co.  
Cleveland, Ohio.  
Northern Ohio Labs.  
Dallas, Texas.  
Porter T. Bennett.

Write us if you can't get EIMAC'S from your dealer  
Dayton, Ohio  
Standard Radio Parts  
Detroit, Mich.  
Radio Specialties Co.  
Denver, Colorado.  
Interstate Radio  
Fayetteville, N. C.  
Hunter Brothers.  
Fresno, California.  
Ports Mfg. Co.  
LaCrosse, Wisconsin.  
SOS Radio Supply.  
Little Rock, Ark.  
Vinson Radio Co.  
Los Angeles, Cal.  
Radio Supply Co.  
Radio Television.

Newark, New Jersey.  
Wholesale Radio Svc.  
New Orleans, La.  
Shuler Supply Co.  
New York City.  
Gross Radio, Inc.  
Wholesale Radio Svc.  
Oakland, California.  
Electric Supply Co.  
E. C. Wenger Co.  
Oklahoma City, Okla.  
Southern Sales Co.  
Peoria, Illinois.  
Radio Mfg. Engrs.  
Philadelphia, Pa.  
Radio Electric Svc.  
Herbach & Rademan

Pittsburgh, Penna.  
Cameradio Co.  
Portland, Oregon.  
Wedel Company, Inc.  
St. Paul, Minnesota.  
Lew Bonn Company.  
San Francisco, Cal.  
Offenbach Electric.  
Seattle, Washington  
Seattle Radio Supply.  
Spokane, Washington.  
Spokane Radio Co.  
Toronto, Ont.  
Canadian Tire Corp.  
Tulsa, Oklahoma.  
Radio, Inc.  
Wheeling, W. Va.  
Cameradio Co.

# Amateur News

The Amateur's Legion of Honor

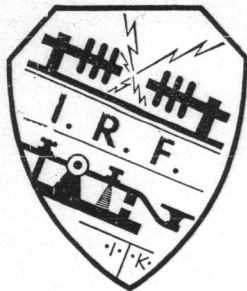

This department is edited by the Secretary of the International Radio Fraternity, Kenneth Isbell, radio W6BOQ, KFI, KECA. All communications concerning the International Radio Fraternity as well as inquiries from any amateur as to the requirements for membership, should be addressed to IRF Headquarters, International Radio Fraternity, 2705 1/2 St. Andrews Place, Los Angeles, California.

## IRF NEWS

● The International Radio Fraternity is pleased to announce the acceptance of the following for membership: W1BD, Roy L. Gale; W6LCN, L. M. Van Eaton; W1DBG, Vincent J. Murphy, president of the Bristol Radio Club of Bristol, Conn.; W6GK, George G. Glade; W9NTW, B. K. Willoughby, president of the Northeast Iowa Ham Club of Decorah, Iowa; and W6EGH, Wallie A. Gee, who for the past three years has been very active in

traffic, actually handling thousands of messages out of the United States.

## 28 MC Contest

● The 28 MC QSO contest which has taken place during this year was won by Byron Goodman, W6CAL, of San Francisco, Calif. An award of a year's subscription to "RADIO" was to have been given to the first person to hold a QSO of over 2000 miles during this year. W6CAL worked W4AJY on 28 MC, and confirmation has been received from both parties to this effect.

## W6KMD

● The two photos show an elaborate display of transmitter and receivers set up by Kenneth Richardson, W6KMD, of 1226 41st Ave., San Francisco, Calif., at the recent San Francisco Hobby Show at the Sutro Museum. In constant operation were four receivers and mixing panel. Transmitter: 150 watt, 47 Xtal, pair 46s, and two 210s. This is an example of what IRF men are doing to put amateur radio before the public. This exhibit was operated for one week, and numerous messages were handled. Mr. Richardson is an old-timer in radio, having had his first ham rig in 1908, also commercial Certificate of Skill in 1911, several other first class commercial tickets and amateur tickets since then, member and associate of Institute Radio Engineers of New York in 1914. He is on the air now on 7030 KC. Men of this high standard make up the ranks of the IRF.

● These IRF news columns are written for the interest of members and non-members. In giving these personal bits of news, the writer has tried to show the reader, whether member or not, that IRF men are none but the very best of radio amateurs with long experience in the field. The fraternity was originated with the idea of banding

together all of the best radio amateurs, so that ample pressure can be exerted when required to protect our privileges. IRF members will not back down and run away from the facts.

● Insignia pins which may be purchased by members for \$1.75 are 1/2-in. high and look just like the insignia cut in the upper left corner of this page.

● Members of IRF will receive presidential ballots with the next issue of "Lightning Jerker". Be sure to mail your vote to IRF headquarters. This is your duty as an IRF man.

**CAPITOL DIVISION NEWS:** Levin D. Powell, W3VJ, Division Chief for the Central division, is very anxious to get his division men into action, and is contacting each man requesting a monthly report so that he can acquaint himself with each man and know what his activities are. Bill Ellsworth, ex-W1BZD, is now residing in Philadelphia, and his new call is W3FED. Bill is also a very active member in the Capitol Division, just as he was when he was up in the East Coast Division. Although he has only been in the Capitol Division for a short time, he is meeting and contacting new men every day, and is finding lots of good men of IRF calibre during his daily work.

**CENTRAL DIVISION NEWS:** W9DEA, Leonard Collett, is another specimen of an enthusiastic IRF worker, and at the recent May convention in Minneapolis he represented the International Radio Fraternity in a very lengthy talk for the interests of those present at the convention.

W9NTW, a new member of this division, has given the IRF quite a bit of publicity in the Northeast Iowa Ham Club of which he is president. Tnx OM.

**WEST COAST NEWS:** VKTRS, chief engineer at Australian broadcast station 7HO, paid a visit to the Southern California gang during a brief stop-over here. He is on his way to England.

K5AT visited W6WO. K5AT has been transferred to the Naval Base at San Pedro and will sign his own call, W7ERY. W6HDV recently worked Columbia on 7 MC, a new country for his DX list.

W6HZZT is the winner of the Los Angeles section of the 1934 Sweepstakes Contest. W6HDV and W6WO have recently received 7 MC heard cards from Turkestan, USSR.

W6DOB received notice in a Russian magazine that he was heard in Russia when using only 50 watts input. His new transmitter is almost ready to go on the air.

W6EGH worked Greenland on 7 MC, which added a new country to his nice DX list.

W6AET is off the air for a few weeks awaiting completion of new rig, with 400 watts input, 7 and 14 MC. CW.

VE5EO has been coming in very nicely on 14 MC. More of the IRF members should QSO him for a real good chat.

W6CAL is doing fine work on 28 MC. He is using a crystal controlled transmitter with an Eimac 50T, 100 watts input.

W6CXV, working Europeans on 14 MC, per his usual habit.

During the second week in May the 14 MC band proved to be very good for European contacts during the evening hours. Many local W6 stations took advantage of this condition and worked several Europeans apiece.

SM7YN, in Sweden, added a new country to many of the Los Angeles gang on 14 MC.

PA0XF, F8EO, F8EX, G5BD, ON4UU, SM7YN, and VU1AG were the most consistent DX heard by W6WO on 14 MC recently.

## Have You Written Your Congressman?

● More and more members of Congress are learning, for the first time, that the radio amateur of America is an important cog in the wheel of communications. An army of well-trained radio amateur operators can be of unquestionable service to our Government in time of emergency. Discoverers of the short-wave spectrum, the radio amateurs are rightfully entitled to their share of the air. There is hardly a Congressman who knows the true conditions under which the American radio amateur is forced to operate. Neither do these Congressmen know that the broad channels which the amateurs once occupied were literally handed to the commercial communications interests by a group of self-styled amateur radio leaders. When you write to your Congressman, tell him that you are a member of IRF . . . tell him that IRF is a body of qualified licensed radio amateurs, that none but licensed radio amateurs are permitted to join IRF . . . that IRF asks the support of every member of Congress to help in securing wider frequencies for the amateurs at the Cairo Conference. Tell your Congressman that there are almost 40,000 licensed radio amateurs in the U. S. . . . that these men have no ulterior motives, that they number among their ranks many thousands of highly-trained technicians and operators, that their stations can be tied together to make up many a chain of important communications channels across the nation.

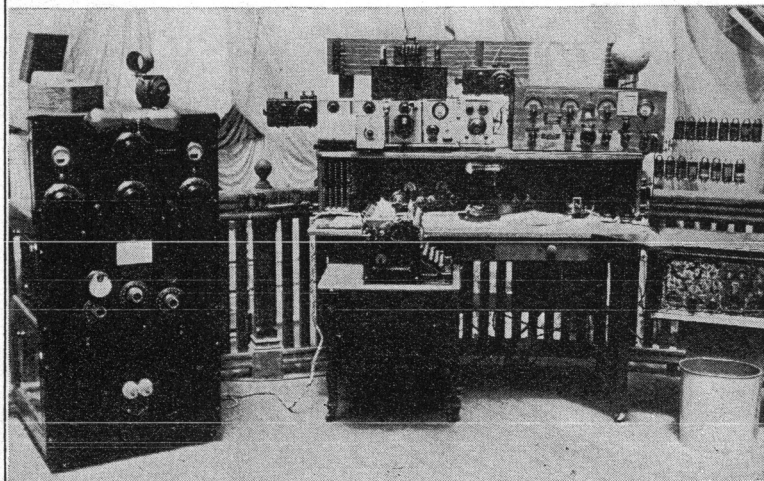
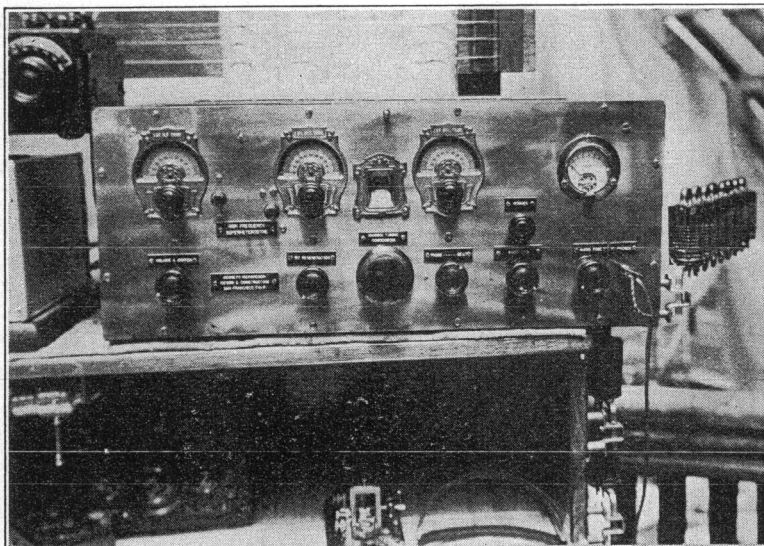

W6KMD—Kenneth Richardson's amateur station which was on display and in operation at the Hobby Show recently held in San Francisco. The transmitter is a 150-watt, with 47 crystal oscillator, two 46s in the buffer stage and a pair of 210s in the final. W6KMD is an IRF brother.

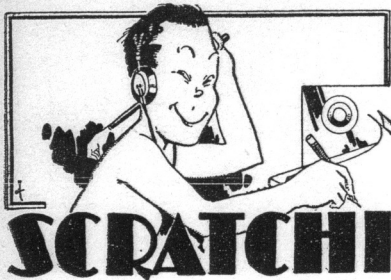

Osockme, Japan.  
April 23, 1935.

Hon. Editor of "RADIO" with respects. Dear Sir Ed:— I am in receipt of ham sheet from Marin County amateur radio club near your city which make reference to new radio effect which are discovered by amateur with name Donnelly. Ham sheet say much effect are known as "Donnelly Effect", and such effect are recognized by peculiar action of transmitter to wits: Donnelly effect are the condition which are present when the amplifier oscillates but the oscillator don't. Scratchi has often experience similar effects and he have just discovered another new effect which are known as noted "Scratchi Effect." It are similar to well known "skin effect", only Scratchi effect are more pronounced. It are an effect which are produced on the skin. Skin burn off of fingers when Scratchi put finger between neutralizing condenser plates in high power final amplifier stage. I ask you, Hon. Editor, to prove such effect for yourself. Scratchi find that it work every time without fail, and on any finger which you choose to put in between condenser plates, except thumb, which will not fit between ordinary spacing. It are always best to keep thumb in reserve so that key can still be pressed with thumb, which now bring to mind to Scratchi why so many punk ham sendings are on air.

Another effect which Scratchi have discover are known as the "seventeen dollar effect." It are caused by dropping high-power transmitting tube on floor and best part about such effect are that it are not usually necessary to pick up tube again. It are simply necessary to send seventeen dollars to tube profiteers for new bottle. Scratchi have been leading hectic life since last he have writ you, Hon. Ed. He have radio-fone on air, employing grid saturated modulation system. Scratchi have make QSO with sweet YL friend on air and she make invite for me to come make visit at her house where she live and have ham and egg breakfast with her. She say come at nine o'clock in morning and make visit, but Scratchi are too anxious to meet such YL and he make haste for YL residence two hour ahead of time. Scratchi make knocks on YL shack door and tough looking OM husband come to door and say who in hell are YOU? And I say I are Scratchi. And he say you so and so, you are the yokel who my wife cook for after I go to work each morning. And he reach out for my upper structure and hit me hard along side of place which the good Lord have provided to call my head, but which YL husband say are no head at all, but only place to hang head phones on, and ever since that morning Scratchi have been hearing strange high frequency rumbles in upper structure of my head which sound like leaky antenna insulator.

Scratchi have learn good lesson, Hon. Ed. and he will never again make visit to YL for ham and egg breakfast. I now cook at home, and if I have some ham, I make my own ham and eggs, if I have some eggs. Hoping you enjoy the same kind of a similar experience, even though you will not be courageous enough man to print such in your sheets, I are remaining yours and forevermore,

Hashafisti Scratchi.

**NEXT MONTH!**  
Reports of Controlled Carrier Tests  
by "RADIO"  
Don't Miss This Feature!

Beat Frequency Audio Oscillators  
20 to 12,000 Cycles  
Direct Dial Calibration  
**THE AUDIO-TONE MODEL 12-A**  
\$45.00 Net, Less Tubes  
\$66 Net, with A.C. power supply and output trans.  
Licensed under A. T. & T. Co. Patents  
**THE AUDIO-TONE OSCILLATOR CO.**  
901 LONGBROOK AV., STRATFORD, CONN.



## McMURDO - SILVER

# Do You Know That

We still believe that more 5C professional superheterodynes have gone into amateur stations in the last six months than have any other commercial superhets—at least, so our sales tell us.

There must be a reason for this condition—and there is—performance plus. Ask anybody you work why he reports you R9 and we'll bet that once out of every three times a 5C in his shack will be the answer.

You know the 5C's predecessor, the 5B, was chosen and used exclusively by W9USA all through last year's Fair and that alone tells the story of performance plus. The roster of it and the newer 5C's users includes governments, commercial companies, engineering universities and amateurs. But read what W6DYQ says of it, for a typical example.

And get this one—the 5C is the only amateur receiver whose maker thinks it good enough to dare offer it to you on a ten day trial basis—hook 'er up, operate it for ten days, and if you're not absolutely satisfied, just return it undamaged and you'll get your money back. It's just so good we get less than half of one per cent back for refund!

### Why the 5C is better

is told by its features—send a stamp and you'll get the story promptly. But outstanding are: no loss of signal strength on single signal. Automatic volume con-

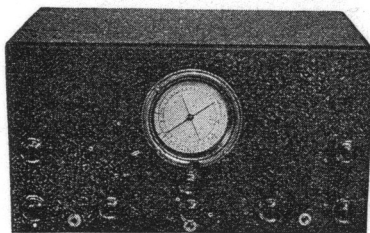

THE 5-C

automatic volume control—or cut it out by a switch. Band spread and full coverage (1500 to 23,000 kc. on one dial by pulling out the single tuning knob. One high gain real t.r.f. stage that cuts out images and boosts weak signals. Very low inherent noise. Absolute day in and day out dependability and performance such as the commercials demand.

Order one today on 10-day trial and find out what a real receiver can do for your schedules

**McMURDO SILVER INC.** 3362-F N. Paulina St. CHICAGO, ILL.

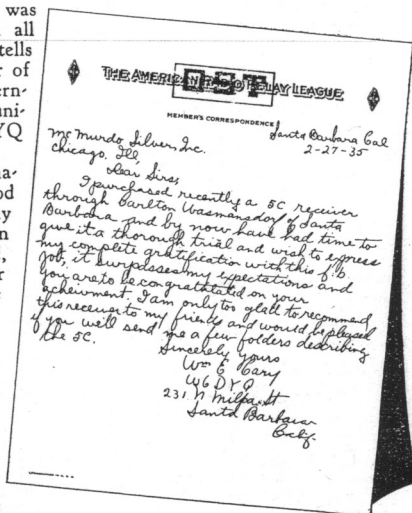

automatic volume control—or cut it out by a switch. Band spread and full coverage (1500 to 23,000 kc. on one dial by pulling out the single tuning knob. One high gain real t.r.f. stage that cuts out images and boosts weak signals. Very low inherent noise. Absolute day in and day out dependability and performance such as the commercials demand.

**\$1 Brings You the Next Four Issues of "RADIO" —Subscribe NOW**

### RADIO ENGINEERING

RCA Institutes offers an intensive course of high standard embracing all phases of Radio. Practical training with modern equipment at New York and Chicago schools. Also specialized courses and Home Study Courses under "No obligation" plan. Illustrated catalog on request.

**RCA INSTITUTES, INC., Dept. RA-34**  
75 Varick St., N. Y. 1154 Merchandise Mart, Chicago  
Recognized Standard in Radio Instruction Since 1909

### NEON TATTLETE TESTER

"Tells the Tale"

Tests for blown fuses, condensers, or resistors, r.f. peaks and wave length, polarity, open circuits, live lines, defective spark plugs, etc. 100 uses—pocket size. With instructions—post-paid, a \$1.00 bill.

Send for catalog of other Tattleites, Instrument, Aircraft and High voltage Littelfuses, Radio Fuses, Mtgs., etc.

**LITTELFUSE LABS.**  
4503 Ravenswood, Chicago, Ill.

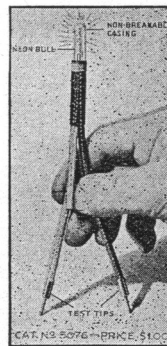

**LITTELFUSES**

We carry a complete line of

## United Transformers

in stock.

For prices and data on controlled carrier modulation see April and May Radio.

**EIMAC** 50-T \$13.50  
150-T—\$24.50

Cased Filament transformer for above  
5 volts CT 12 amps—\$2.95  
5 volts CT 20 amps—\$4.95

NEW BARR DB3 TRANSCEIVER  
IN STOCK  
\$16.20 NET

**Gross Radio, Inc.**

51 Vesey St., Dept. R New York City

## TURNER TYPE

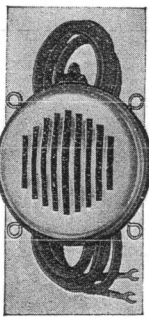

### "G" Crystal Mike

A new diaphragm construction gives tone quality and response never before attained with a diaphragm type microphone. The Type "G" employs the

Brush Torque crystal unit. Torque crystals are more efficient, offering greater output. Stocked by all leading jobbers. For further details see your jobber or write to

THE TURNER COMPANY  
CEDAR RAPIDS, IOWA



Brings You the Next 4 Issues  
of "RADIO"—Subscribe Now

## The Bias Shift Class A Amplifier

(Continued from page 21)

ages. The filament transformer for the class C tube should be insulated for the maximum DC plate voltage.

The average plate impedance of the modulator is quite high when no audio signal is present so that most of the available plate voltage is dropped across the modulator. The smaller part of the plate voltage is dropped across the constant resistance represented by the plate filament circuit of the class C RF amplifier. Thus, with no audio signal present, the plate voltage across the class C amplifier is low, as is its power output. As a larger audio signal is impressed across the grid circuit of the modulator, the bias shift tube operates to reduce the modulator bias which reduces the voltage drop across the modulator, resulting in an increase in the DC input and RF power output of the class C amplifier. This refers only to the syllabic variations, or modulation. The audio modulation, of course, varies the power input and output of the class C stage in the conventional manner. The syllabic modulation can be followed on a DC milliammeter in series with the plate voltage supply to both tubes, although a DC milliammeter has too much lag to follow the high speed audio frequency modulation.

The overmodulation indicator, shown connected across the plate RF by-pass condenser, indicates overmodulation. Negative overmodulation of any class C amplifier is characterized by the fact that the plate becomes somewhat NEGATIVE with respect to the filament for part of the audio cycle. The 879 high vacuum rectifier is connected so that it passes current through the 10,000 ohm load resistor and the DC milliammeter (an ordinary 50c receiver tuning meter is OK) whenever the plate of the amplifier goes negative, with respect to the filament. The filament winding which supplies the 879 must be able to stand the maximum plate voltage. Overmodulation in a controlled carrier transmitter cannot usually be detected by ordinary means, and it can be very bothersome if not detected.

Getting back to the modulator and its adjustment. R1 and R3 will depend on the transconductance of T2, the bias shift tube.

The higher the resistance of R3, the farther will the bias be shifted, for a given audio signal. This is also somewhat true of R1, although to a smaller extent. The main purpose of R1 is to stabilize the bias so that line voltage changes, etc., will have a somewhat smaller effect on the operating conditions. As far as actual operation goes, however, R1 could be eliminated. This would leave the plate resistance of the bias shift tube as the stabilizer. The audio filter condenser C1 cannot be eliminated. The value of this condenser is between one and four mikes and will depend on the minimum resistance of R1 in parallel with the tube resistance. R2 is simply the cathode bias resistor for the bias shift tube and is 100,000 ohms for a 56 tube.

The voltage output of the modulator bias supply must be somewhat more than cut-off bias for the modulator tube. The effective modulator plate voltage from which cut-off bias can be calculated, is from 66% to about 85% of the maximum DC power supply voltage. This depends on the ratio of minimum to maximum carrier power obtained.

It should be emphasized that the construction and adjustment of a controlled carrier transmitter is still rather experimental and all of the important adjustments should be conveniently variable. No two transmitters seem to work exactly alike and though extremely good audio quality, combined with lots of power, is being obtained in some

(Continued on page 29)

**EBY**  
QUALITY

Specializes in  
Quality

- BINDING POSTS
- TIP JACKS
- MALE PLUGS
- FEMALE PLUGS
- LOW-LOSS SOCKETS
- A-C SWITCHES
- TAP SWITCHES
- TERMINAL STRIPS
- SHORT WAVE SWITCHES
- MOULDED SOCKETS

Write for Latest Bulletin

**HUGH H. EBY Inc.**  
2066 Hunting Park Ave.  
PHILADELPHIA, PENNA.

W. BERT KNIGHT, Western Representative  
115 W. Venice Blvd., LOS ANGELES, CALIF.

## new! KELLOGG TRANSCEIVER HANDSET

A better all-around Transceiver Handset! Highly efficient single-button Kellogg microphone, super-sensitive Kellogg receiver. Easy to hold. Fits the face. Microphone has greater sensitivity and "flatter" response curve than the usual "mike" of this type. Precision built, as are all Kellogg products. Gold plated diaphragm. Especially processed carbon. Receiver is the product of 35 years experience building telephone apparatus. Bi-polar magnet of cobalt steel. Cadmium plated diaphragm. Small, compact, easy on the ear. Simply and ruggedly constructed and light weight. Cast aluminum triangular handle. Baked black enamel finish. Has 6-foot, 4-conductor, 18-strand tinsel cord of telephone quality. You will be proud to own this unit. Better yet, it's not expensive. Code No. 38-A, 70 ohm receiver, list price \$10.00. Code No. 38-B, 2000 ohm receiver, list price \$11.

KELLOGG SWITCHBOARD & SUPPLY CO.  
1070 W. Adams St. CHICAGO, ILLINOIS

## CANNON-BALL HEADSETS

Made by America's oldest  
manufacturer of headsets

Heavy bar magnets, double pole, aluminum cases, D. C. resistances of 2000, 3000 and 5000 ohms. Sturdy construction, sensitive and faithful in reproduction.

Sold everywhere in America  
**C. F. CANNON CO.**  
SPRINGWATER, N. Y.

**ASTATIC**

## CRYSTAL MICROPHONES AND PICKUPS

Guaranteed instruments, known for their quality, dependability and ruggedness. Extensively used in both Professional and Amateur fields. Send for your literature today!

ASTATIC MICROPHONE LABORATORY INC., YOUNGSTOWN, OHIO

The  
Radio Receptor  
Moving Coil  
(DYNAMIC)  
Microphone

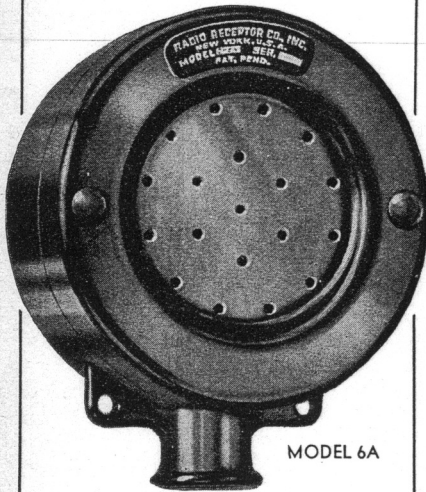

MODEL 6A

Models 6B and 6C

Is the Most Sensitive, Self-Generating Microphone devised for general use.

Requires less preamplification. Hence less noise and more signal.

It has passed two years of grilling service in all types of work before being offered to the trade. List Prices **\$33.00** and up.

*Pacific Coast Representatives*

NORTHERN CALIFORNIA  
KJAER EQUIPMENT CO., 557 Market St., San Francisco

SOUTHERN CALIFORNIA  
FRANK A. EMMET CO., 1341 So. Hope St., Los Angeles  
JAS. J. BACKER CO.

**Radio Receptor Co., Inc.**  
110 SEVENTH AVE. NEW YORK, N. Y.  
*Established 1922*

# Marine 140-B

WITH BUILT-IN  
**CATHODE RAY OSCILLOSCOPE**

"An Exclusive 'MARINE' Feature"

Here is a transmitter designed for the Amateur, that is of such excellent design, workmanship, quality and appearance that it has been chosen by discriminating Short Wave Broadcast stations, governmental, airways and commercial communication agencies.

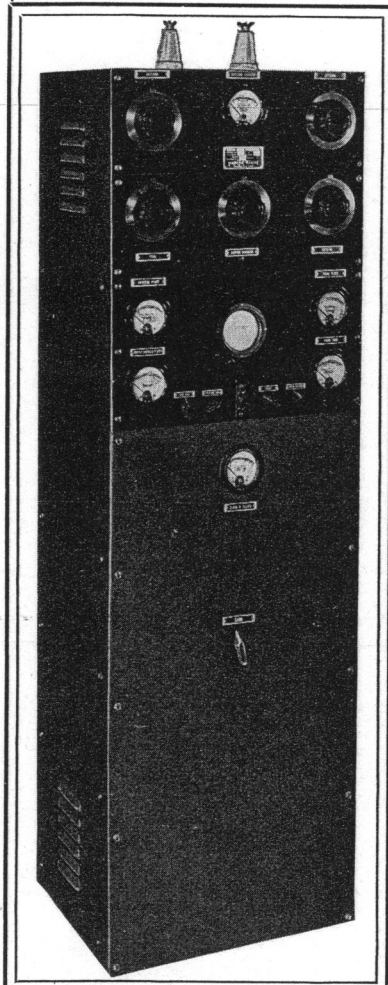

*Technical Data*

- POWER OUTPUT—Conservative rating, 100 watts.
- FREQUENCY RANGE—Standard—15,000 Kc. to 1500 Kc.
- CATHODE RAY OSCILLOSCOPE—At a glance, over or under modulation or distortion can be detected. Used as a percentage of modulation indicator, it is possible to maintain 100% modulation. Either trapezoidal or envelope figures can be had.
- PERMANENT NEUTRALIZATION — Neutralization which remains permanent regardless of the antenna or frequency used.
- HIGH FIDELITY AUDIO CHANNEL—The speech amplifier has a frequency response of 30 to 10,000 cycles, + or - 1 1/2 D.B., with a gain of 125 D.B. which makes it ideally suited for use with a Crystal microphone.
- BIAS SUPPLIES—Absolutely no batteries of any kind required.
- ANTENNA IMPEDANCE MATCHING NETWORK—Capable of efficiently matching and transferring energy from the final stage to the antenna.
- AUTO TRANSFORMER—Tapped in 5 volt steps from 90 to 130 volts so that the transmitter can be used with full efficiency on any line voltage.
- CABINET—The MARINE 140-B transmitter is housed in a steel broadcast station type cabinet rack with detachable hinged rear door and is finished in a baked wrinkled enamel. The Bakelite panel finish is optional. Gloss (illustrated), satin or wrinkled may be had. Dimensions 60" high, 19 1/2" wide, 15" deep.

**GUARANTEE**

ONE YEAR UNCONDITIONAL GUARANTEE

DESCRIPTIVE LITERATURE — Send stamp for descriptive folder with detailed information and photographs. You will be astounded at what we are offering at such an extremely moderate price.

## MARINE RADIO COMPANY

(Formerly L. I. MARINE & ELECTRIC CO.)

124-13 - 101st Ave. Richmond Hill, New York  
Telephone: CLeveland 3-2400 Cable Address: "Elecmarine"

### The Bias Shift CC Amplifier

(Continued from page 28)

cases, there are other stations on the air using CC modulation that leave a great deal to be desired.

**AUTHOR'S NOTE:** The Bias Shift class A amplifier operating as a series modulator acts differently from the same bias shift amplifier operating as a choke or transformer coupled audio amplifier. This is due to the fact that carrier controlled series modulation is somewhat like resistance coupled amplification. It is well known that resistance coupled power amplification usually cuts the maximum undistorted output of a power amplifier in half. While the series modulation circuit does not cut the modulator power output in half, it does cut it down somewhat, due to the drop in modulator plate voltage through the class C resistance, which varies with the syllabic modulation.

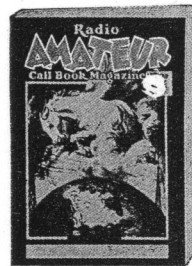

### NEW EDITION Now Ready

The only Radio Call Book published that lists all of the radio amateurs throughout the entire world.

Also a complete list of high frequency commercial stations, International abbreviations and amateur prefixes, "Q, R, & T," systems for reporting signals, New US radio inspection districts, high frequency press, time and weather schedules, and high frequency commercial stations listed by frequencies.

Every ham should have one. Always up-to-date. Single copies \$1.25. Annual subscription \$4.00.

**RADIO AMATEUR CALL BOOK, INC.,**  
600 SOUTH DEARBORN ST. CHICAGO, ILL

**RADIO CLUBS!**

Write for Special Group Subscription Rates for "RADIO"

## AT LAST



Any Battery Radio Set, whether 2 volt, 6 volt or 32 volt can now be made All Electric, with a Carter Genemotor — the modern "B" Eliminator.

Greater Power—No Current Fluctuation—Minimum Operating Cost—Electrically and Mechanically Guaranteed.

There is a Carter Genemotor for Sound Systems, Two-Way Police Radios, Transmitters, etc.

Write for our latest catalog—it's free.  
**CARTER MOTOR CO.**

365 W. Superior St. Chicago

## MILLIONS IN USE

- Two Year Guarantee
- Low Power Factor
- Long Life
- Self Healing
- Efficient and Compact
- Patented and Patents Pending



The superior quality and performance of millions of Duco Condensers are recognized all over the world.

NOW GUARANTEED FOR 2 YEARS

Manufactured by

**DUMONT ELECTRIC COMPANY, Inc.**

514 Broadway New York, N. Y.

Write for free Catalogs, Sales and Jobber Territory

**\$1.00 brings you the next four issues of "RADIO"**  
—Subscribe NOW!

## BUD LO-LOSS TRANSMITTING SOCKET

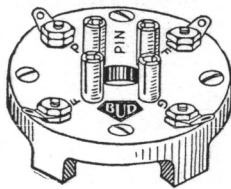

Flush Mounting for 50-Watt Tubes.

Most efficient transmitting socket on the market. Positive contacts. Base of socket is made of Isotex. All metal parts are heavy brass and nickel plated. For Low Loss Transmitting socket this is what you want.

No. 226.....Price \$1.50



Your Favorite Jobber Stocks  
BUD RADIO Parts

Write for New 1935 Catalog

List prices shown in this advertisement are subject to 40% discount when purchase is made from an authorized BUD jobber. If your jobber cannot supply BUD parts, send your order direct to us together with your jobber's name and we will make shipment direct.

**BUD RADIO, INC.**

1937 E. 55th St. Cleveland, Ohio

## W6ITH

(Continued from page 22)

of accidental removal of load from the modulated amplifier. The power supply for this modulator is directly below, being rated at 1250 volts at one-half ampere. The rectifier housings built by Collins Radio Company are very convenient inasmuch as the rectifiers are in plain sight of the operator, are fully shielded and amply protected from accidental contact. The covers pull off for easy access.

The last rack to the right contains the radio-frequency portion of the 75 meter phone transmitter operating on 3904 KC. In addition, all the power supplies for the radio-frequency section are mounted in the lower part of this rack. The tube complement consists of a 47 crystal oscillator driving an 865 screen grid buffer which drives a Western Electric 304A amplifier. These three stages are shown on the lower of the three dialed panels. These stages are metered in every desirable point on the meter panel directly above. Above this meter panel is the final class C modulated amplifier. This stage consists of a pair of carbon plate 203As in push-pull, plate modulated. The meters for this stage, as well as for the plate current to the modulators, are directly above. On top is the "pi" section network coupling the final stage into a 500 ohm transmission line. The far end of this transmission line terminates in a horizontal half-wave matched impedance antenna. The antenna is a half-wave about ground and gives excellent sky-wave concentration. The signals in downtown Oakland, California, six miles away, are very weak, but at the same time are R9 in both Los Angeles and Seattle.

The bottom power supply uses a pair of 866s and is rated at 1250 volts at one-half ampere, supplying the final 203As and the 304A amplifier stage. Another power supply below the exciter stages uses a single 83v to supply the crystal and buffer stages. The normal input to the final is 500 watts.

Although "ITH" is well along in the Sixth District calls, Tibbetts operated 6PD as far back as 1926 and built the first police radio system in the West at Berkeley, California, in 1927.

## High-Power Output Stage

(Continued from page 18)

to a value greater than that of its neighbor. This effects an unbalanced plate current which may be as much as 30 mills. The transformer must be properly designed to take care of this in the primary of the output transformer, or both a loss of low frequencies and a high harmonic content will be produced.

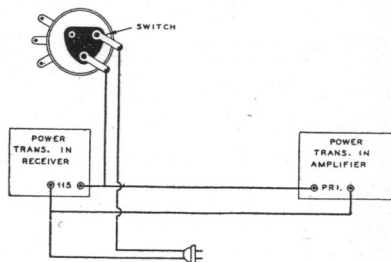

FIG. 6

Connection of amplifier and receiver for operation from one switch.

The method of obtaining fixed bias in this amplifier is one which the writer has sponsored for some time and found both very simple and economically practical. A 45 tube is used as a half-wave rectifier, fed from one side of the power transformer high volt-

(Continued on page 31)

## WHY HAVE MANY OF THE OUTSTANDING AMATEUR STATIONS SELECTED "WIRELESS SHOP" CONDENSERS? BECAUSE THEY STAND UP UNDER THE PEAK SURGES OF MODERN HIGH POWER. THEY WILL DO THE SAME FOR YOU.

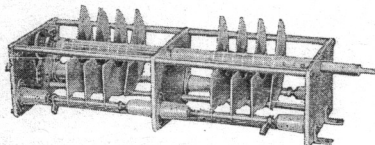

Built of the finest materials and finished like a watch by high power specialists. Any capacity or voltage rating. The WS-1502035 is just the job for the new 354 Gammatron—or 150-T in a kilowatt push-pull rig. We'll gladly give you constructional data on building up this layout. It sure does its stuff. WS-1502035—Split Stator—35 micro-mikes and 15000 V. rating per section and—

IT ONLY COSTS YOU \$15.00 NET. Shipping Weight 8 lbs.

And to neutralize the 354's, etc., we have built a companion. We can now supply the WSN-852 in either single or twin—rotor positions can be independently adjusted to compensate for any tube variations. A real neutralizing condenser for a real high power job, 10 micro-mikes max. capacity. Single sells for \$3.33 net. Wt. 2 lbs. Twin is only \$6.66 net, shp. wt. 3 lbs.

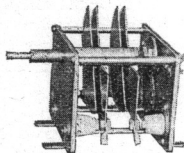

This little split-stator job was designed for the fellow who doesn't use over 2000 volts on the plate. It is rated at 40 micro-mikes and 4000 v. per section. Just the thing for 800 series tubes—203A and 60T on medium power. It sells for only \$8.00 net. Shipping wt. 4 pounds. We have many other condensers to select from. Order from this add direct. Send M. O. or check in full, including postage or 50% with order, bal. C. O. D.

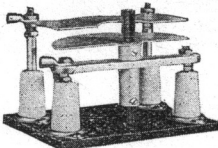

## AUDIO PRODUCTS CO.

4185-7-9 W. SECOND ST.

A. J. EDGCOMB  
Since 1907

LOS ANGELES, CALIF.

## Announcement!

Beginning in the July issue of "RADIO" a series of ultra-modern amateur receivers will be described. Chas. Perrine Jr., W6CUH, will describe his de luxe amateur special high-frequency receiver—Frank C. Jones will show his own h.f. receiver and it is hoped that a new circuit and improved design for the popular Banehawk will also be ready in time for the next issue. Rebuild your receiver during the summer months... "RADIO" will bring you the newest innovations. Don't miss the important summer issues.

# Suppressor Grid Modulation and the RK-20

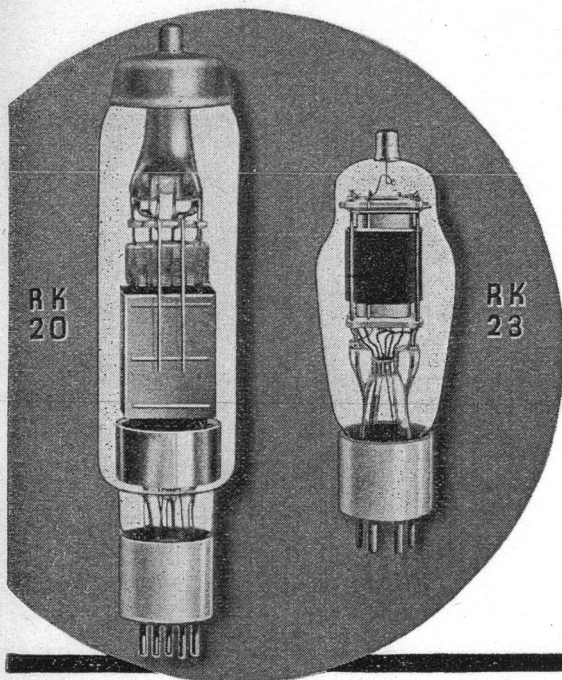

are linked inseparably in amateur radio. The performance of the RK-20 in this application is appreciated by thousands of amateurs.

Yet the original advantage of low excitation requirement still holds true with other familiar methods such as control grid bias, screen grid or simultaneous plate and screen grid modulation of the RK-20.

The RK-23 and RK-25 provide the same flexibility with a minimum of excitation. For the low power station they offer the best in internal shielding, and low losses through the use of an Isolantite base.

## RAYTHEON PRODUCTION CORPORATION

30 East 42nd Street New York    55 Chapel Street Newton, Mass.    445 Lake Shore Drive Chicago    555 Howard Street San Francisco

# RAYTHEON

4 - PILLAR RADIO TUBES

RAYTHEON PRODUCTION CORP. Dept. H-5  
 Dept. 00, 30 E. 42nd St., New York, N.Y.  
 Please send 1935 Tube Chart

Name \_\_\_\_\_  
 Address \_\_\_\_\_  
 City \_\_\_\_\_

*Browning Has Hit it Again!*

WITH This Newest ALL-WAVE RECEIVER

Heart of the BROWNING 35

**NOISE WON'T BOTHER YOU in your S.W.**  
 Listening Post if you own a Browning 35!  
 A new All-Wave Receiver with the remarkable TOBE TUNER that assures you round-the-world reception with the clarity and strength of locals! Especially designed for S.W. Listening Post Observer who appreciates the importance of actually getting high signal to noise ratio. Featured editorially by practically every radio publication—praised by engineers and jobbers the country over—

**SERVICEMEN!**  
 Servicemen—get our remarkable money making plan telling how to build, sell and install the Browning All-Wave Receiver, utilizing customers' present cabinets! They SAVE MONEY . . . and you make a big Profit, too! List Price—\$66.50. (TOBE TUNER as separate unit . . . \$31.00) Get full circuit diagrams, list of parts, and special discounts all sent ABSOLUTELY FREE. Write your favorite jobber. If he can't supply you, write direct to ToBe Deuschmann Corp., Dept. F-12, Canton, Mass. (Export Dept.: 105 Hudson St., New York)

**BROWNING 35**  
 With the TOBE Tuner

## High-Power Output Stage For Small Receivers

(Continued from page 30)

age winding. Approximately 10 mills is thrown away in this circuit to provide a low resistance bias supply. Filtering is accomplished through a resistance-capacitance and choke-capacitance filter.

Fig. 2 illustrates the general appearance of this amplifier. Incidentally the chrome plated cans against the black chassis make this unit a beautiful job. The twin jack at the left takes the plate and B plus leads from the output of the receiver. The twin jack at the right connects to the loudspeaker voice coil. The output transformer used in this amplifier incorporates a universal voice coil winding with impedances of 2, 4, 8 or 15 ohms, so an additional speaker can be used, if desired. The primary of the power transformer is brought out through the cord at the extreme right.

Fig. 3 illustrates the circuit diagram of the complete unit and Fig. 4 shows an underneath view of the chassis, illustrating the extreme simplicity of wiring. The complete wiring of one of these amplifiers takes less than an hour and a half. The general procedure in converting a standard pentode output receiver to this high power stage is as follows:

- The pentode output tube in the receiver is changed from pentode connection to triode connection and the plate and B plus leads are brought out from the receiver to the left twin pack on the amplifier. (See Fig. 5.)
- The cord from the primary of the power transformer in the output stage is connected to the primary of the plate transformer in the original receiver, so that the main line switch on the receiver will

(Continued on page 35)



## 1935 SPRING & SUMMER ALLIED CATALOG

You will find complete answers to all of your Short Wave Transmitting and Receiving needs in this new Catalog, devoted 100% to Radio. Prices are LOWER than ever before—it will pay you to consult this book before you do your radio buying. Every leading standard Short Wave line is listed—outstanding new gear is fully described. Use the ALLIED Catalog and take advantage of our personal service. Let us help you with quotations for building any type of circuit—let our competent engineers and Amateurs in on your problems. We can always serve you better at ALLIED.



## ALLIED RADIO

ALLIED RADIO CORP.  
 833 W. Jackson Blvd.,  
 Chicago, Dept. J.  
 Send me your FREE 1935 Spring and Summer Catalog.

Name \_\_\_\_\_  
 Address \_\_\_\_\_

# CROWE "MICROMASTER"



No. 192  
MICRO-  
MASTER  
(Illustration  
1/2 size)

## Precision Recording Control For All Short Wave Sets

Has auxiliary pointer affording exact repeat indication of wave length. Stations however closely crowded may be accurately logged.

Slow speed ratio 45 to 1; fast speed 9 to 1 in 360 degrees. Secondary pointer travels faster than double pointer.

Can be supplied with other scales or with special calibrations made to order. Specify scale wanted. Made in several sizes: 3 1/2", 4" and 2 3/4" diameter of scale.

New escutcheons are featured for the various sizes and have a synthetic transparent non-inflammable Croglas convex crystal eliminating breakage. The crystal inserted in escutcheon seals air leakage or coupling behind baffle.

Write for Bulletin No. 60, covering Dials, Plates and Knobs for Constant Impedance and Gain Controls. Large variety and latest forms. Complete line of material for Amateurs, Experimenters and Set Builders.

Export orders receive special attention, Cable Address—CROWNAME CHICAGO.

## CROWE NAME PLATE & MFG. CO.

1755 GRACE STREET

Established 35 Years

CHICAGO, ILL., U. S. A.

Pacific Coast Representative—W. BERT KNIGHT, INC.

## Warner Commissions

(Continued from page 8)

subscribe would increase the number of subscribers and thus the net profits of QST.

Now note what the plan did for Warner. His total commissions suddenly jumped from \$898.21 in 1919, (when QST was the property of Maxim and Tuska), to \$3,715.34 in 1920, (when QST was the property of the ARRL). Then to \$5,972.46 during the year 1921. Then to \$10,255.48 during 1922. Then to \$10,322.24 during 1923. And note that the last two months of 1923 Warner was paid commissions of \$2,062.07—over \$1,000 a month; and for the first three months of 1923 \$4,215.33—over \$1,400 a month. And this, mind you, is commissions, not total remuneration!

There exists here a mystery that should be cleared up by the present directors for their own enlightenment if for no other reason. Even after calling all QST subscribers "members" a 25 cents commission on each yearly paid dues accounts for only a small part of the total yearly commissions paid to Warner. Take for example the year 1923. On December 8 of that year Treasurer Hebert told the board of directors the membership was then 14,000. Presuming that every one of these members had paid his dues Warner's commission of 25 cents from the dues would have been \$3,500. His total commissions during 1923 were \$10,322.24. That leaves \$6,822.24 to be accounted for as his "25 per cent of the net profits of QST". That means that the net profits of QST for the period in question must have been claimed to be \$27,288.96!

Similar reasoning can be applied to the other yearly periods, resulting in similar startling disclosures. The mystery is, how could ay such net profits have been claimed for QST in its early youth when in its later robust maturity it showed little profit it any?

Now look at the continuation of the schedule of payments. Effective July 1, 1924, the directors made a new contract with Warner. It provided that he receive a salary of \$600 a month, plus 10 per cent of the net profits of the whole organization. Note that the 1924 amounted to \$1,035.50. Note that if commissions paid for the last six months of \$1,035.50 was 10 per cent of the net profit of the whole business of the League, including QST, then the net profit must have been claimed to be \$10,355 for the six months, or at the rate of \$20,710 for the full year! If the ARRL as a whole had been making any such net profits it would seem that there should have been accumulated by that time, (away back in 1924, ten years ago), a surplus far exceeding the announced surplus of the present day. It doesn't take a Hindu to make figures perform weird tricks.

Now another look at the schedule of payments. Note that immediately thereafter—during 1925—Warner received no commissions, indicating that the League, including QST, made no net profits. That was a big drop—from \$20,710 one year to nothing at all the next.

In 1927 Warner is shown to have got commissions of \$2,164.37. This was probably when sales of the Handbook started. This book is said to have "Saved the League". It didn't "save" the League. The League wasn't broke nor anywhere nearly broke. It merely saved the League's capacity for paying Warner the biggest returns any similar organization ever paid its manager. The American Federation of Labor, the biggest, most powerful and best administered fraternal organization in the world has for years paid its very able president \$6,000 a year.

(Continued on page 33)

**FB!! SEZ THE GANG!!**  
And So—They're Going Fast (and Strong!)  
These Genuine-New-Guaranteed

**Western Electric**  
**211-D FIFTY WATT \$ 4.90**  
**TRANSMITTING TUBES**

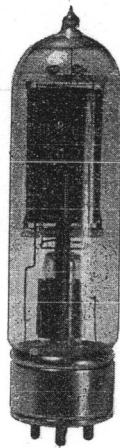

Standard Fifty Watter base. Standard characteristics (Interchangeable with type 211 and 211-A). Has new long life filament! Rated RF output as an amplifier—100 WATTS!

Every tube is in its original Western Electric carton! The WESTERN ELECTRIC name is your guarantee of highest quality! We guarantee REAL VALUE and COMPLETE SATISFACTION!

Regular selling price—\$17.50. Harrison's SPECIAL PRICE—only \$4.90! Your money cheerfully refunded if you do not agree with us that this is the GREATEST VALUE ever offered to the Amateur! Every tube is UNCONDITIONALLY GUARANTEED FOR THIRTY DAYS! (Broken glass or burnt-out filament the ONLY exception!)

### \* PLEASE NOTE!

These brand new, fully guaranteed, genuine Western Electric 211-D tubes are not to be confused with the type 211-E which is designed for AF work!  
These TUBES are FB for RF!

SEND  
FOR  
FREE  
HAM  
SHEET

### W.E. 211-D CHARACTERISTICS

|                         |             |
|-------------------------|-------------|
| FILAMENT VOLTS          | 10          |
| FILAMENT CURRENT        | 3 AMPERES   |
| NORMAL PLATE VOLTAGE    | 750 to 1000 |
| AVERAGE PLATE CURRENT   | 65 MA       |
| PLATE IMPEDANCE         | 3500 OHMS   |
| NORMAL RF POWER OUTPUT: |             |
| AS AN OSCILLATOR        | 50 WATTS    |
| AS AN AMPLIFIER         | 100 WATTS   |

Mail orders filled promptly. Careful Packing. Safe Delivery. Deposit Required.

**HARRISON RADIO CO.**

142 Liberty St., Dept. PR7  
NEW YORK CITY

**\$1 Brings You the Next 4 Issues of "RADIO"**



# Slide RESISTORS



When exact resistance required is unknown but must be arrived at by experimental adjustment . . . and even changed occasionally . . . use AEROVOX Slide Resistors, because:

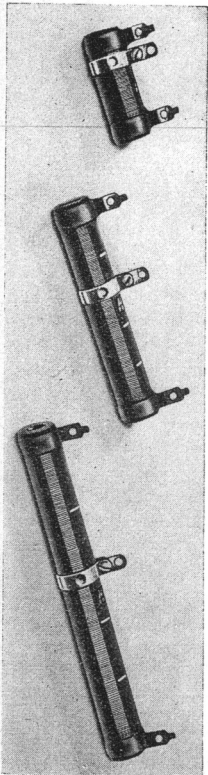

• Readily adjusted to exact resistance value yet absolutely permanent when once set.

• Quality wire . . . crack-proof refractory tubing . . . precisely wound.

• Wire ends brazed to lugs . . . handy soldering tab terminals.

• Heavily coated with vitreous porcelain enamel . . . permanent sealing . . . moisture and damage proof.

• Conservatively rated . . . adequate heat dissipation . . . longest service life . . . Just install them . . . adjust them . . . forget them!

• In 10, 30, 50, 75, 100 and 200 watt ratings . . . 1 to 100,000 ohms. All units provided with horizontal mounting brackets. Extra sliders available.

**FREE CATALOG:** New 1935 Edition . . . covers the complete condenser and resistor line. Also sample copy monthly Research Worker. Just write!

## AEROVOX

CORPORATION

84 Washington St.

Brooklyn, N. Y.

### HEADPHONES for the EXPERT

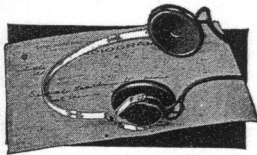

The Famous SPECIAL TRIMM

#### FEATHERWEIGHT

Precision built, like a fine instrument, sturdy, ultra-sensitive, yet the entire weight on your head is but FOUR OUNCES!

Available Throughout the World

**TRIMM**  
RADIO MFG. CO.

1528 ARMITAGE AVE. CHICAGO, U. S. A.

Succeeding years show Warner receiving increasing commissions. By the time of the annual meeting of May, 1929, it was apparent, at least to Director Babcock, that Warner's total remuneration was again getting out of bounds, and Babcock induced the less forceful directors to limit it to \$10,000 a year and with no more commissions. At this meeting Warner's staunch ally, Segal, tried to raise the ante to \$12,000 but the other directors refused to support him. At the following meeting—May, 1930—the United States was well into the present depression and executives all over the country were cutting their own salaries. Nevertheless, with Mr. Babcock prevented by illness from being present, Segal did succeed in getting Warner's salary boosted to \$12,000.

It will be seen from the schedule that in the four succeeding years Warner cut this salary a little. But he cut at the same time the other employees of the League who were enjoying no salary boosts. He couldn't very well cut the whole force without taking a cut of some kind himself. But it will be seen from the schedule that even so he pulled out during the tough four years of the depression—1930 to 1933—\$44,206.03.

To sum up: This particular story does not concern itself with President Maxim's annual encomiums on the "high ethical standards always maintained in our organization", nor with Hebert's constant exhortation for "loyalty to our League", nor with Warner's mastery of the practice of half-truthing, nor with that Pollyanna "Code of the Amateur" of which Segal was the author. All those peculiarities of Headquarters' demeanor are stories unto themselves. This one has to do simply with a grave doubt of the method of the book-keeping that could have resulted in the huge sums Warner obtained. It is here submitted that, quite aside from the legality or the justice of arbitrarily re-naming all QST subscribers "members", the accounting that could cause such astounding results in favor of the one man who could direct it is decidedly open to question. It is further asserted that the only way in which the present directors can free the League from the suspicion of grave irregularities is to institute a complete and independent investigation of the whole administration of the ARRL, of the true earnings of both the ARRL and QST, together with the authorization and propriety of all payments made to Warner.

In response to this the ARRL officers will exclaim, "Why, our books are audited by certified public accountants"! Well, whether that is true or not of the years in question it makes no difference, for certified public accountants take their directions from those who employ them. Their ordinary routine is the checking of entries in the books. They do not go into the purposes back of the entries nor the motives back of the purposes. And this is what the present directors of the ARRL need to find out in order intelligently to inform themselves and the members whose interests they are bound to represent.

Clair Foster, W6HM.

## A. T. CRYSTALS

With New Low Loss Power Type Mounting

Priced as low as \$4.95

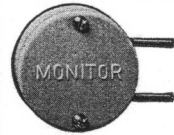

See Your Dealer  
Bulletin on request

Monitor Crystals  
2802 West Avenue 32  
Los Angeles, Calif.



## Here's a "Troupe" that Wows 'Em!

Four husky boys, these, that have been on most of the world's best circuits.

Fathered by old man Radiohm himself, he and his three sons, Kid Suppressor, Kid Resistor and the new member of the team, Big Boy Sound Projection Control, are in the spotlight of popularity with servicemen and experimenters everywhere.

How these boys can work! It's a pleasure to watch 'em . . . smooth, efficient, noiseless and each performance as reliable as the next.

Note: Mr. Trouble Shooter . . . stock up with Centralab Replacement parts . . . the cheapest in the long run.

## Centralab

DIVISION OF GLOBE UNION MFG. CO.  
MILWAUKEE, WIS.

RADIOHMS - SUPPRESSORS  
RESISTORS



**CHICAGO MORRISON HOTEL**  
In the Heart of the Loop  
SINGLE ROOM \$2.50 UP  
\$4.00 Double  
Each, with Bath, Servidor and Circulating Ice-Water  
LEONARD HICKS  
Managing Director

# Jones 5-Meter Super

(Continued from page 14)

like any AVC broadcast receiver. Occasionally when listening to extremely strong signals, the IF sensitivity control is of use, although this control is normally left at full gain setting. A switch is provided for shorting the loudspeaker when using this receiver in conjunction with a powerful 5-meter transmitter.

The power supply is well filtered by means of a two-section filter, using the loudspeaker field as the second section. This part of the circuit is purely conventional.

The semi-tuned RF stage greatly simplifies the receiver because no tuning control is necessary for the RF grid circuit. This grid circuit is resonant broadly over the whole amateur five-meter band, and since the ratio of L to C is large, the gain of this stage is fairly high. The resonance curve of a non-regenerative tuned circuit at five-meters is extremely broad, especially if the tuning and stray capacities are small. If this receiver is to be used on any other ultra-short wave band it would be necessary to change the RF coil as well as the detector coil. This circuit

eliminates the need of a two-gang tuning condenser and minimizes common coupling between the RF and the oscillating detector circuit.

The detector should oscillate weakly for maximum sensitivity and because this degree of oscillation varies slightly over the range of the tuning condenser, a variable screen voltage control is brought out to the front panel. When very strong signals are received, the detector should oscillate a little harder, in order to prevent an overloading effect which would result in noticeable audio distortion.

## 100 Watt CW Transmitter

(Continued from page 11)

is accomplished in the usual manner—disconnect the plate voltage and make sure there is no RF current in the final tank circuit with the antenna disconnected.

A very convenient method of adjustment of this type of tank circuit is to use Mazda lamps as a dummy antenna, tuning the two

tank condensers for maximum lamp brilliancy. These tuning adjustments will show the maximum output obtainable for different values of plate current. Beyond a certain value of output, the plate current increases (at resonance setting of the two condensers) without an appreciable increase of antenna power. The plate current reading for maximum output power into the dummy antenna can be used as a pre-determined value when the regular antenna is connected to the final amplifier. This antenna coupling method has been used at W6AJF from 160 meters down to 10 meters, and sometimes even on 5 meters with satisfactory results, especially with long antennas or 500-ohm RF feeders.

## Class B Amplifiers

(Continued from page 13)

condenser with a working voltage of 1000 will be satisfactory if one side of the secondary is connected to plus "B" instead of to ground. This practice allows no DC strain to be placed on the blocking condenser.

Transformers were built in exact accordance with this data and tests were conducted in the laboratory. The photos show the setup and the equipment used to determine the power output, frequency response and harmonic content. The curves of Fig. 4 give the results, and Fig. 6 is the circuit of the setup.

The plate and grid current curves are actual readings on DC meters in the circuit of both tubes. The watts output measurement was read on a Rawson thermo-ammeter in series with the load resistance. The harmonic percent was read on a General Radio Harmonic Analyzer at a frequency of 400 cycles. The plate loss curve was calculated as the difference between the DC input and the audio output. It should be noted that the harmonics increase rapidly after 95 watts output, but this was partly due to distortion in the driver stage. The driver tubes started to pull grid current at about this point. The maximum plate loss occurs at about 30 watts output and decreases to about 35 watts for the two tubes at 95 watts output.

The tubes were operated for 10 minutes with 100 watts output at 1000 cycle input. The harmonic per cent was quite high and it is not recommended that the tubes be operated at such a high output. The test was made to prove that there was some reserve power available.

After the tests were made and the curves plotted, which required many hours of tube operation, the tubes were again tested for static plate and grid current and were found to be slightly better than when they were taken from the carton.

The power supplies must have good regulation; mercury-vapor rectifiers and choke input are absolutely essential.

The frequency response curve of Fig. 5 shows that the low frequency response was better than calculated, so that a smaller core with a fewer number of turns could have been used. This would have improved the high-frequency response at a sacrifice of the bass.

It can be said that when working under ordinary conditions of voice or music input, 175 watts of input to a class "C" RF amplifier can be modulated 100% on peaks with excellent audio quality by a pair of 801s and the tubes should give good service life.

THERE ARE



For Every Class B Requirement.  
Send us your problem. Write for our  
Free 25 page Transformer Manual

MANUFACTURED BY

**BALSLEY & PHILLIPS INDUSTRIES**  
1455 North Gordon Street, Hollywood, California

REPRESENTED BY

**WESTERN SOUND ENGINEERS**

1341 N. Kenmore Ave.

Los Angeles, Calif.



**CRYSTAL BLANKS.** Best quality. Brazilian Quartz. Special Quantity Prices. W6KLR-W6HQT, Box 144, Palm Springs, California.

In answer to many requests, "RADIO" can now supply back copies of the January, February, March and April, 1935, issues. These 4 issues sent postpaid for \$1.00. "RADIO", Pacific Bldg., San Francisco, California.

3 Bound Volumes of 1934 copies of "RADIO", January to December, 1934. Bound in loose leaf ring binder. \$3.00 postpaid. "RADIO", Pacific Bldg., San Francisco, California.

"RADIO'S" March 5-Meter Jones Superheterodyne, Metal Cabinet completely built \$13.50; Concentric line transmitters \$10.00; P.P. \$12.50. We build to order. Write for information. PRECISION RADIO LABORATORIES, 109 East 94th Street, Brooklyn, New York.

845 Graphite plate tubes (2). Unused. Also two unused 211s. Make cash offer. C. B. Robbins, 2356 Cecelia Avenue, San Francisco, California.

QSLs, 75c per 100. 2 colors. Order direct from this ad. Post paid. W9DGH, 1816 5th Ave. North, Minneapolis, Minnesota.

ADDRESS ENVELOPES AT HOME, spare time. \$5.00-\$15.00 weekly. Experience unnecessary. Send stamp for particulars. Hawkins, Box 75-EG, Hammond, Indiana.

80 and 160 Meter Crystals, \$1.35 each, Post paid. W9DGH.

# The A. R. R. L. Board Meeting

(Continued from page 6)

The board voted to split up the Pacific Division and create of the lower half a new Southwestern Division. In the official minutes it will look odd that the resolution should have been presented by the director of the Pacific Division. Mr. Culver had no choice; he was so instructed by the last Pacific Division Convention. The convention was dominated vocally by the small southern group of administration supporters who engineered the secession. Their first movement was to go over the head of their own director and put their plan secretly up to the League headquarters. They did in fact caution a headquarters officer not to let Director Culver hear of their action.

The convention voted almost solidly for secession. I myself was the only man who voted no. And when the Culver resolution was voted by the board there was only one "No", the vote of Dr. Woodruff, director of the Atlantic Division. Thanks, Doctor; I guess you and I are the only hams in captivity who know that to split any unit of an amateur organization is invariably to weaken the whole.

Well, this small group that we out here know as the "Little ARRL" have, for reasons that no doubt seem sufficient to them, cut themselves off from the Pacific Division, Hawaii, Guam and the Philippines. And cut themselves off from contact with one of the ablest directors who ever sat on the ARRL board. Incidentally they have cut off from the Pacific Division all those older and more experienced men who dwell in the south. We of the Pacific Division shall no longer be personally interested in what goes on in Southern California—no more than are we now interested in the affairs of the Northwestern Division. We shall continue to work for governmental recognition of the interests and rights of all United States amateurs, but the organization affairs of the Southerners no longer concern us.

The directors discussed the present requirement that all amateurs who have earned the honor of WAC must be members of the amateur societies of their own countries. After several years of freedom from exploitation these honor men were denied WAC certificates until they joined the dominant society. Then these dominant societies, including the ARRL, saw the opportunity for getting more membership dues and arbitrarily imposed a restriction that was precisely like informing an amateur who had run 100 yards in 9½ seconds that his record would not be recognized unless he joined the Amateur Athletic Union!

The board voted yes in a motion to copy-right the annual reports of ARRL officers that are mailed to directors shortly before meetings. The men who proposed and seconded the motion were not the creators of it. It was for the purpose of discouraging directors from giving their copies to rivals of QST. A waste of time, money and brain-matter on the part of someone at headquarters; for if any publisher were so green as to believe one of these reports would entertain his readers he could publish it whether copyrighted or not. Reports of a corporation are public property and may be published even if copyrighted. This point was settled by the courts long ago. The League's General Counsel could have told the directors that.

Directors Culver and Jabs tried to get a resolution that all prospective members present applications that would indicate whether or not the applicants were licensed amateurs. The purpose being to avoid recurrence of the recent spectacle of an "ama-

teur" society having to keep a corps of men in Washington for weeks to find out how many amateurs there are in it. Warner's minutes will say, "But after discussion the motion was rejected." The "discussion" consisted chiefly of Warner's objections to it. Insurmountable obstacles were cited—in spite of the fact that that was the practice throughout the years before Warner came to the ARRL.

Director Culver got beamed when he proposed that each QSL manager be provided with successive new copies of the call book. This would not have been a reward for arduous and unpaid service but merely by way of the League's providing part of the tools these QSL managers require in their work. The ARRL advertises as one of the inducements for joining the League, "Our QSL service", then it gets a lot of kind-hearted amateurs to do the work without pay. Warner said in his annual report a year ago that by this device the ARRL was "saving" some \$2,500 a year. Supplying necessary call books to these kindly hams would cost the League some 25 or 30 dollars a year, so Director Culver's proposal was turned down. Great stuff, eh!

It was the sense of the board that there shall be another meeting of the directors this year—probably in the autumn and probably somewhere in the middle west. This is an encouraging prospect, for no board can hope to direct the affairs of a corporation by meeting only once a year and permitting the important business of the institution to be conducted and vital policies established meanwhile by a small group of paid employees.

On the whole the amateurs of the United States may enjoy greater satisfaction from this last meeting of the directors than from any previous meeting within my knowledge. Signs are not lacking that at last the courageous and independent thinkers who have at heart only the rights and interests of all amateurs are taking the lead away from the self-seeking and the subsidized.

Clair Foster, W6HM.

## Output Stage For Small Receivers

(Continued from page 31)

cut off both units at the same time. (See Fig. 6.)

- c. The voice coil winding of the loudspeaker is disconnected from the secondary of the original output transformer and brought to the right twin jack on the amplifier.

Final tests on this amplifier indicate that a peak output of 28 watts is available but a conservative clean rating is 18 watts into the speaker voice coil. The frequency characteristic was made extremely good by the use of matched input and output transformers. The overall frequency discrimination is less than 2 DB from 60 to 8000 cycles.

To take full advantage of the fine frequency characteristic made available by this amplifier, a combination woofer-tweeter speaker arrangement can be used. Any of the standard dynamic tweeters can be used, or a standard 11-in. dynamic can be used for the low end and one of the new inexpensive crystal tweeters can be connected across the primary of the output transformer for the high end. The field supply of the original speaker can be used to supply the larger speaker without any change.

The original design of this unit is for specific application to the Browning R 35.



**New**

**ELECTRAD**  
**VOLUME CONTROL**

## Guaranteed QUIET

Built on a radically new engineering principle, and individually tested for noise.

Current is evenly distributed over the flat outer rim of a rigid Bakelite ring, upon which gently glides a special alloy floating contact shoe.

Molded Bakelite case, when mounted, extends only ½ inch back-panel. New-type power switch (approved by underwriters) may be instantly attached or removed by a single screw. Long, easy-to-cut aluminum shaft. All standard replacement values.

Mail Coupon for FREE Descriptive Folder, and General Catalog of Resistors for Every Purpose.

Floating contact shoe glides over resistance element in straight path.



Resistance element baked on flat outer rim of Bakelite ring.

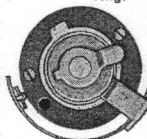

175 Varick St., New York, N. Y.

**ELECTRAD**  
INC.

1935 CATALOG

MAIL COUPON FOR

Please send new Resistor Catalog . . . Check here for folder on new QUIET Volume Control.

Name . . . . .

Address . . . . .

.....PR-6

**\$1 brings you the next four issues of "RADIO"—Subscribe NOW.**

A standard high fidelity 11-in. Wright De Coster speaker (1800 ohm field) is recommended by Browning for use with this power amplifier. The field supply is taken from the tuner. However, the amplifier is applicable to any tuner or receiver having a single pentode for output. If a 245 tube is used in the output, no change in the tube connections need be made, except to bring out the plate and B plus lead to the input of the power stage.

Everything considered, this simple and inexpensive amplifier will convert any small receiver to a unit equal in fidelity and power output to the best of the \$250 class.

# Now--High-powered radio books

to help you in the solution of engineering, experimental, and practical problems

1. **RADIO ENGINEERING**, by F. E. Terman, Stanford University. Comprehensive engineering treatment of important vacuum-tube and radio phenomena. Analyzes circuits and tubes and reduces them to quantitative relations predicting performance of tubes and radio apparatus with accuracy and certainty. Includes material on radio aids to navigation. 750 pages, illustrated, \$5.00.

2. **RADIO OPERATING QUESTIONS AND ANSWERS**, by A. R. Nilson and J. L. Hornung. Helps you to pass examinations for radio operator's licenses by giving hundreds of questions typical of those used on tests, together with full, clear, correct answers. Covers all phases of tests,—apparatus, laws and regulations, etc.—and applies to broadcasting, marine, police, aeronautical, and amateur radio. 350 pages, illustrated, \$2.50.

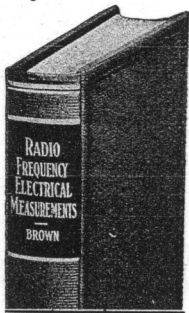

3. **RADIO FREQUENCY ELECTRICAL MEASUREMENTS**, by H. A. Brown, University of Illinois. A combined textbook, manual and guide for laboratory manipulation of electrical measurements at radio frequencies. Explains theory and principles, describes the necessary laboratory steps, and discusses the precision attainable, precautions, and general merits of the method. 386 pages, illustrated, \$4.00.

4. **COMMUNICATION ENGINEERING**, by W. L. Everitt, Ohio State University. Expository treatment of fundamentals of communication. Stresses principles. Covers classification of impedance elements, networks using linear bilateral impedances, networks using unilateral impedances, networks using non-linear impedances, negative resistance effects, coupling between electrical and mechanical circuits, coupling between electrical circuits and free space. 567 page., illustrated, \$5.00.

5. **THEORY OF THERMIONIC VACUUM TUBES**, by E. L. Chaffee, Harvard University. Comprehensive treatment of fundamentals of thermionic emission and the vacuum tube. Covers use of tube as amplifier and detector as well as its general properties. New, original material on large-signal regeneration, regeneration in couples circuits, detection, all types of amplifiers, non-linear elements, etc. 652 pages, illustrated, \$6.00.

6. **HIGH-FREQUENCY MEASUREMENTS**, by August Hund. Complete, thorough reference work on measurements of high frequency. Presents theory and practice of measuring all manner of electrical quantities as well as present-day radio apparatus. Methods presented in manner practical enough to meet needs of anyone interested in increasingly important high frequency art. 491 pages, illustrated, \$5.00.

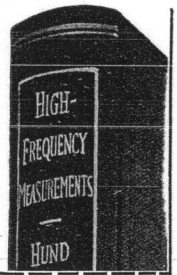
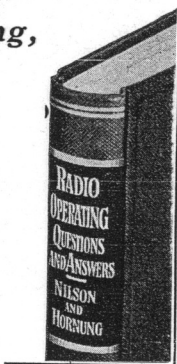

## Major Armstrong's Newest Discovery

(Continued from page 9)

"The practical utility of the system will be principally on the ultra-short and microwave signalling systems, as the bands of frequency or width of the channel required is greater than on normal broadcast wave lengths.

"For example, the band width at present used on the Empire State-Haddonfield circuit is about 150,000 cycles. This would not be a practical band width to use on present-day broadcast channels but it is quite feasible on the 40,000,000-cycle wave used at the Empire State. The range of modulation frequencies which can be transmitted from the best transmission systems today does not extend beyond 8,000 cycles, and only frequencies up to about 5,000 cycles can be effectively used without encountering interference from adjacent channels.

"On account of the extremely short wave lengths it has been possible to transmit all modulation frequencies from thirty to 16,000 cycles, and to receive them with what engineers call a flat characteristic.

"The theory on which the problem was solved flies directly in the face of all previous mathematical deductions. The old theory of the way to shut out static assumed that that best that could be done was to narrow the band of the selective systems at the receiver as much as possible without shutting out the signal. By narrowing the band down to a width just sufficient to admit the signal, it was believed that under these conditions the signal to static ratio would be the best.

"Where the signals and disturbances are of the same order of magnitude, I find the exact opposite to be true. With proper methods of transmission and reception, the wider the band, the better will be the signal to noise ratio.

"Of all the inventions which I have made, regeneration, the superheterodyne, and super-regeneration, the present was by far the most difficult to do and is the hardest to understand. An illustration of the difference between research in 1912 and present-day research is the comparison between the work on regeneration and this invention.

"Regeneration was finished in 1912 after six months work. One vacuum tube was used, and one measuring instrument only was employed in making a few dozen measurements. In this invention during the experimental work, over a hundred tubes were in operation simultaneously, tens of thousands of measurements were made, and countless pieces of apparatus built.

"In regard to the measuring apparatus, almost every measuring instrument made by the General Radio Co., the principal manufacturer of radio measuring equipment, was used. The total number of pieces of apparatus constructed in this work has long been lost sight of, but some idea of the amount of work involved can be gathered from the fact that the records since last October show fifty-five panels constructed and put into operation. The technical progress has been so rapid that apparatus become obsolete almost as soon as it was constructed. For example, three complete transmitting equipments, which were used in converting the Empire State transmitter to the present system, have been installed with the year."

Major Armstrong stated that the invention could be placed in operation immediately in point-to-point communications. Regarding the length of time required to put it into use in broadcasting available to the general public, he would not venture a prediction, beyond saying that many non-technical problems were involved here.

### SEE THESE BOOKS 10 DAYS ON APPROVAL—SEND THIS MCGRAW-HILL COUPON

McGraw-Hill Book Co., Inc., 330 W. 42nd St., N. Y. C.

Send me books checked below, for 10 days' examination subject to approval or return. In 10 days I will pay for the books, plus few cents for postage, or return them postpaid. (We pay postage on orders accompanied by remittance.)

- 1. Terman—Radio Engineering, \$5.00
- 2. Nilson and Hornung—Radio Operation Questions and Answers, \$2.50
- 3. Brown—Radio Frequency Electrical Measurements, \$4.00
- 4. Everitt—Communication Engineering, \$5.00
- 5. Chaffee—Theory of Thermionic Vacuum Tubes, \$6.00
- 6. Hund—High-Frequency Measurements, \$5.00

Name.....

Address..... Position.....

City and State..... Company..... R-35

(Books sent on approval in U. S. and Canada only.)

## New BIRNBACH 5-METER ANTENNA

\$2.50 and \$3.00

IDEAL for portable 5-meter transceivers and beam arrays. Three aluminum tube sections, adjustable to desired frequency from 3-ft. (closed) to 9-ft. (open), and tightly locked by brass bushings. Highly efficient (4½" high) standoff insulator base.

Two types: (1) Complete with standoff, \$3.00 list. (2) Extensible antenna only, with ¼-20 threaded end for attaching to insulator, directly to transceiver or other portables, \$2.50 list. Write Dept. PR-6 for Details.

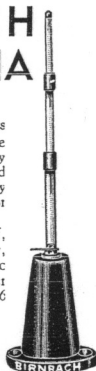

BIRNBACH RADIO CO., Inc.  
145 HUDSON STREET NEW YORK CITY

## STEEL RACKS

Two 8x14" panels with 8x12½x1½" decks removable as units. Strong angle steel frame. Black crackle finish. Net price \$4.25, 13 lbs.

## STEEL CABINETS

7x10x6¼". Panel and deck removable. Hinged lid. Crackle finish. Net price \$1.95, 5 lbs. Bottom dust cover \$.25 extra, 1 lb.

R. H. LYNCH

970 Camulos St. Los Angeles, Calif.  
Order direct or see your dealer.

# Here is the Largest, Most Modern and Most Authoritative Handbook for the Radio Amateur and Experimenter

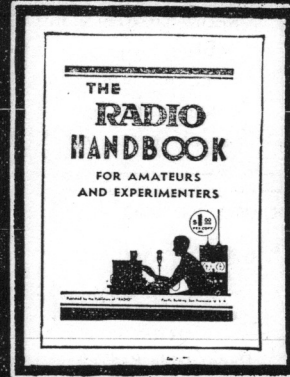

## Tells How to Build Better Sets—

- How to Get More Out of Your Present Sets
- How to Design, Construct and Operate Them

# The Handbook by "RADIO"

*Deliveries This Month Definitely Assured*

• There are Handbooks and Handbooks, but there is ONE Handbook that stands head and shoulders above the others—the Handbook by the magazine "RADIO". The reason why so many people are buying the Handbook by "RADIO" is because this book is NEW, tells you what you want to know . . . solves those intricate problems, shows how to build BETTER transmitters, receivers, radio telephones, antennas, test equipment, etc. And everything is told in such a manner that even the novice can understand and apply it. In the Handbook by "RADIO" there are 64 pages of NEW facts on receivers, from a one-tube to the de luxe multi-tube crystal filter superheterodyne. The Frank C. Jones amateur and short-wave superheterodynes have been proclaimed the most valuable and PRACTICAL of any yet designed. The Hawkins system of class BC grid bias modulation for radio-

telephony is the only system which gives complete, linear and symmetrical modulation. The medium power radiotelephones described in the Handbook by "RADIO" are far ahead of any other systems, yet lower in cost. The elaborate chapter on Radiotelephony will be of tremendous help to any amateur, novice or engineer in solving the many intricate problems of radiotelephony. Many systems of controlled carrier modulation are shown. Truly, there is nothing else like it available, anywhere.

The measuring instrument chapter is a worthy one. It tells how to build the most inexpensive kinds of test sets for all practical amateur radio purposes. You do not find this information elsewhere.

The chapter on c.w. transmitters is as new as tomorrow, because it tells you how to design, construct and operate transmitters using the

NEW tubes, NEW circuit, NEW exciter units. The chapter on analyzing the transmitter is alone worth the price of the book.

That's not all. The chapter on antenna design, tuning, calculating and locating is far ahead of the times. Amateurs will welcome the many fine, exclusive antenna features found in this chapter. Frank C. Jones wrote this chapter for you; that's all you need to know.

To cap the climax, Frank C. Jones has a 64 page chapter on 5-meter sets in this book . . . and what a chapter it is!

In this Handbook by "RADIO" you get the PRACTICAL side of amateur radio, PLUS more than the usual amount of theory, formulae, charts, etc. In this book you will find a transmitter, receiver or antenna of your choice . . . one that will give you BETTER results, cost less to build. Send your dollar now for a copy of this great book. Literally, it's selling like hot-cakes.

## ONE DOLLAR PER COPY

Send Your Orders to  
"RADIO", Pacific Building,  
San Francisco, California

Radio Dealers and Jobbers who desire to advertise in these columns are invited to write for rates.

# RADIO BUYERS' GUIDE

A Monthly Listing of Reliable Radio Dealers and Jobbers who solicit the patronage of our readers. Buy from your nearest Dealer or Distributor. He is dependable and reliable.

## CHICAGO, ILLINOIS

### Chicago Radio Apparatus Company, Inc.

415 South Dearborn Street  
Harrison 2276  
Dependable Radio Equipment  
Established 1921

Bulletins on request.  
Everything for the amateur.  
Get our very low prices.

## CHICAGO, ILLINOIS

### MID-WEST RADIO MART

520 South State Street  
CHICAGO

Write for Special Catalog—Free

## SCHENECTADY, NEW YORK

### ATLANTIC RADIO SUPPLY CO.

712 Broadway

Complete Equipment Stocked for  
Service men—Amateurs—Experimenters  
Let us quote you

## OAKLAND, CALIFORNIA RADIO SUPPLY CO.

2085 BROADWAY.

Hammarlund, Yaxley, Carter, National, Johnson, IRC, Cardwell, Miller, Morrill, Flechteim, Triplett, Haigis Transceivers  
W6GFY

## ST. PAUL, MINNESOTA

### LEW BONN COMPANY

2484 University Avenue

Rex L. Munger, W9LIP, Sales Engineer

Radio Wholesaler

Complete Stock

## BUFFALO, N. Y.

### DYMAC RADIO

216 E. Genesee St.

CL 2080

Complete Stock Amateur Parts  
STANDARD DISCOUNTS

—W8AWK—

## LOS ANGELES, CALIFORNIA

### RADIO SUPPLY CO.

912 SO. BROADWAY

The Amateurs'  
HEADQUARTERS of the WEST

All Nationally Advertised Parts for  
Receiving and Transmitting carried  
in stock at all times.

9 Licensed Amateurs on Our Staff



### New Cornell-Dubilier Porcelain-Encased Condensers



A NEW line of porcelain encased mica transmitting condensers, designed for amateur, police and small broadcast transmitters, has been brought out by the Cornell-Dubilier Corporation, 4377 Bronx Boulevard, New York. Designated as the Type 86, the line includes thirteen sizes ranging from .00005 mf. to .1 mf., in voltage ratings from 2,000 to 12,500 volts.

These new condensers are especially recommended for plate blocking, grid and tank applications. Their power factor is extremely low and they will carry their full rated load over long periods without heating up.

The mica condenser elements are hermetically sealed in heavy glazed porcelain containers, which are provided with mounting feet and screw terminals. These ceramic cases are not subject to absorption effects when placed near the powerful fields of tank inductors, and they therefore eliminate the appreciable loss that occurs when metal cased capacitors are used in a crowded transmitter.

The net prices of the Type 86 condensers vary from \$2.25 for a 10,000 volt, .0001 mf. unit to \$6.90 for a 3,500 volt, .05 mf. unit. These new products are now available through all Cornell-Dubilier jobbers and dealers.



### Amperite Pre-Amplifiers For Ribbon Microphones

Its quiet naturalness, ruggedness, disregard for weather conditions and low feedback are several of the reasons why the velocity microphone has gained so rapidly in popularity. The battery operated pre-amplifier for the velocity microphone is quite simple to build. Changing over to AC operation, however, brought in the problem of hum elimination. Without considerable experience, it is quite difficult to build a humless AC pre-amplifier. For this reason it was decided to give velocity microphone users the benefit of the work done during the past two years on AC pre-amplifiers in the Amperite laboratories. The new Amperite pre-amplifier Model APP has a hum level of -100 db. which is far below audibility. Its gain of 63 db. brings the velocity up to a level of -10 db. An actual measured frequency response test showed it to cover 40 to 10,000 CPS ( $\pm 1$  db.). Two No. 6C6 and one No. 80 rectifier tubes are used.

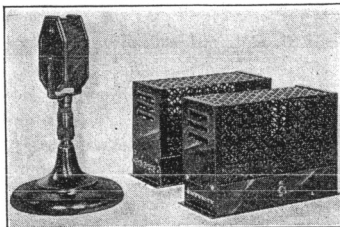

When writing to Advertisers, kindly tell them you saw their announcement in "RADIO".

## CHICAGO, ILLINOIS

### Chicago Radio Apparatus Company, Inc.

415 South Dearborn Street  
Harrison 2276  
Dependable Radio Equipment  
Established 1921

Bulletins on request.  
Everything for the amateur.  
Get our very low prices.

## SAN FRANCISCO, CALIFORNIA



1452 Market Street.

"The House of a Million Radio Parts"

Hammarlund and National sets and parts.  
Sylvania Amateur Transmitting Tubes  
Collins Transmitters.  
Arcturus Receiving Tubes.  
Trimm Phones, all types.  
Johnson Antenna Feeders, Insulators,  
Transposition Blocks.

## FRESNO, CALIFORNIA

### PORTS MANUFACTURING CO.

3265 E. Belmont Ave. Radio W6AVV  
National FB7-SW3 and Parts; Hammarlund,  
Cardwell, Biley Crystals; Johnson Insulators.  
Distributors RCA-DeForest Transmitting Tubes  
Established 1914 Send for Wholesale Catalog

## BUTLER, MISSOURI

### HENRY RADIO SHOP

Complete stock of Collins, Patterson, National, Hammarlund, Silver, RME9D, Super-Skyrider, Peake, Mac-Keys, Eimac, Sylvania, Taylor, Thordarson, Cornell-Dubilier, Cardwell, Dwyer, Triplett, Weston, Turner, Astatic, Trimm, Johnson, Biley, and others at lowest wholesale prices. Your used apparatus accepted in trade, too. Write for any information.

Robt. Henry, W9ARA, Owner. 211-15 N. Main St.

## OAKLAND, CALIFORNIA

### ELECTRIC SUPPLY CO.

12th and Fallon Sts.—"Down by the Lake"

Our New Catalog contains valuable information for Dealers, Servicemen and Amateurs. FREE.

Amperex Transmitting and  
Special Purpose Tubes

Raytheon 4-Pillar Tubes Factory Sealed Cartons

DISCOUNT 40% on most all lines

|       |                |             |
|-------|----------------|-------------|
| W6AZG | } Located in } | W6IDB       |
| W6DTM |                | our store } |

## CHICAGO, ILLINOIS

### Newark Electric Company

226 W. Madison St.  
Chicago

All Kinds of Equipment for  
Service Men - Amateurs - Experimenters  
Write for free catalog

# You can't argue with SALES RECORDS!

## The New CROSLEY KOLDRINK ELECTRIC BOTTLE COOLER

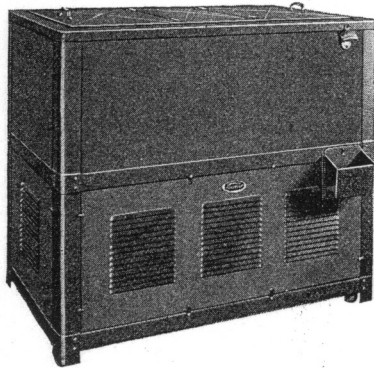

Only ...  
**\$99.50**

DELIVERED...INSTALLED...  
ONE YEAR FREE SERVICE

## The New CROSLEY ICYBALL FOR UNWIRED HOMES

Only ...  
**\$59.95**

F. O. B. FACTORY  
Price includes cabinet,  
stove, Icyball Unit,  
stabilizer and tub.

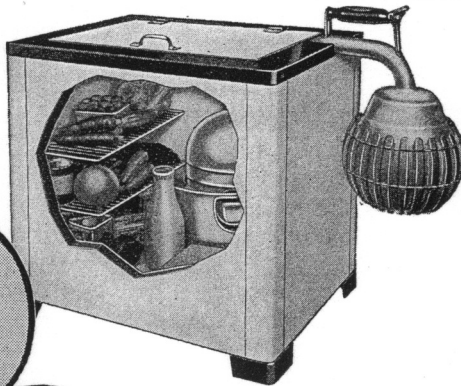

**3 AMAZING  
CROSLEY  
MONEY MAKERS**

in refrigeration that have  
piled sales record upon sales  
record..Meet every condition..give  
you a 3-fold market (A) THE  
WIRED HOME, (B) THE UNWIRED HOME,  
(C) ROADSIDE STANDS, ETC.

A necessity for restaurants, drug-gists, hotels, roadside stands, summer camps, groceries—any retailer of bottled beverages. Cuts cost of refrigeration as much as one-half; increases sales by winning popular approval of the drinks. Of particular value to the small dairyman. What a market! No wonder sales are going up and up! No wonder dealers are profiting.

Wherever refrigeration is needed and electricity is not available. For rural homes, dairies, summer camps, roadside stands, boats. Turns heat to ice. Uses only about 2c worth of kerosene a day. Not one moving part. Makes ice cubes. A dependable refrigerator—low in price, economical to use Gives the Crosley dealer a wide, non-competitive market.

For the wired home, the Crosley Tri-Shelvador, the Shelvador, the Table Shelvador . . . 3 types of electric refrigerators for every purse and purpose, featuring the sensational Shelvador that means—more room; things twice as easy to find; offering a value unheard-of in electric refrigeration.

For unwired homes, summer camps, etc., the new Crosley Icyball . . . turns heat into ice . . . gives all the food protection that any refrigerator can give for 2c worth of kerosene daily. Also a bottle cooler . . .

For roadside stands, confectioneries, restaurants, hotels, etc., the Koldrink Electric Bottle Cooler.

Thus does Crosley cover all 3 markets. Thus Crosley gives to dealers a 3-fold sales lead. The rest is written in sales records that seem almost unbelievable. From 100% to 1000% greater sales during 1935 than during corresponding months last year. Can you afford *not* to get in on this?

**The Crosley Radio Corporation**  
(Pioneer Manufacturers of Radio Receiving Sets)

Home of WLW—the world's most powerful broadcasting station  
**POWEL CROSLEY, Jr., President**  
CINCINNATI

Prices in Florida, Texas, Rocky Mountain states and west, slightly higher.

## ALL SALES RECORDS SMASHED BY CROSLEY SHELVADOR MODELS . . . DUE TO NATION-WIDE PUBLIC PREFERENCE!

**\$79.50 UP**

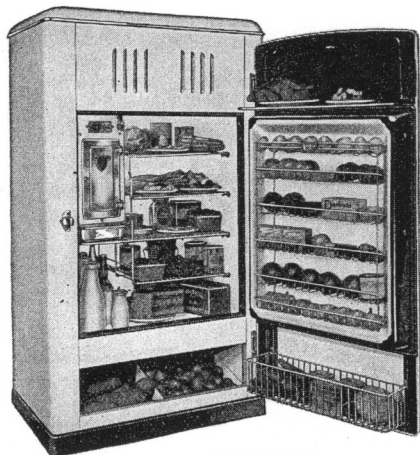

TRI-SHELVADOR

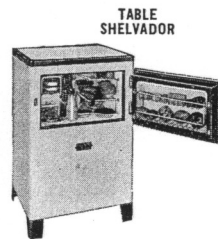
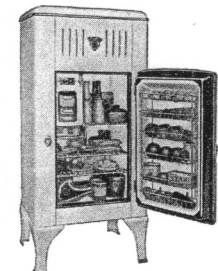

TABLE SHELVADOR



SHELVADOR

**TABLE SHELVADOR**  
. . . 2 models priced from \$79.50 to \$94.50. Uses semi-hermetic rotary compressor. Ideal for small homes, summer camps and cottages.

**SHELVADOR . . . 5 models** from \$99.50 for 3.5 cu. ft. size to \$169.50 for 7.08 cu. ft. size.

**TRI-SHELVADOR . . . 3 models** from \$139.50 for 4.3 cu. ft. size to \$189.50 for 7.08 cu. ft. size.

Both Shelvador and Tri-Shelvador models have—interior light, flat bar shelves, ventilated front, porcelain interior, lacquer exterior. (Most models available with porcelain exterior at slight extra cost.)

Tri-Shelvador models have, in addition, the Shelvador, Shelvatray, Storabin, and self-closing ice-tray chamber door.

CROSLEY SHELVADOR MODELS HAVE SHOWN THE GREATEST SALES INCREASE IN THE HISTORY OF ELECTRIC REFRIGERATION

PRICES INCLUDE DELIVERY . . . INSTALLATION . . . ONE YEAR FREE SERVICE.



## Variactor Controlled Carrier Modulation Acclaimed the Greatest Forward Step in Radiotelephony

Phone men who have switched over to Variactor Controlled Carrier Modulation agree it is the most economical and practical, least critical and simplest of any system of Controlled Carrier Modulation in use.

• • •

THE UTC SYSTEM OF VARIACTOR CONTROLLED CARRIER MODULATION:

- ★ Increases DX coverage many times over.
- ★ Allows power consumption savings of 50% or over.
- ★ Almost doubles Class C tube ratings and will double to quadruple Class B Linear Tube ratings.
- ★ Reduces interference between stations tremendously.
- ★ Increases tube life and power efficiency.

Using the UTC Variactor CCM System the changeover from standard carrier to controlled carrier can be accomplished in less than an hour.

• The 140 watt input controlled carrier transmitter illustrated was described by Mr. I. A. Mitchell in the March, April, May issues of "RADIO". It has all the newest wrinkles in transmitter design—variactor controlled regulation for the output audio stage resulting in 25% more output, lower distortion, increased stability and low hum level. The input will match crystal, dynamic, velocity or carbon mikes. The output will match the 801 variactor controlled carrier RF end. All components used in this transmitter were chosen to meet the most discriminating tastes. For further circuit details consult your local UTC distributor, who will be pleased to let you have the new UTC bulletin No. 11CC.

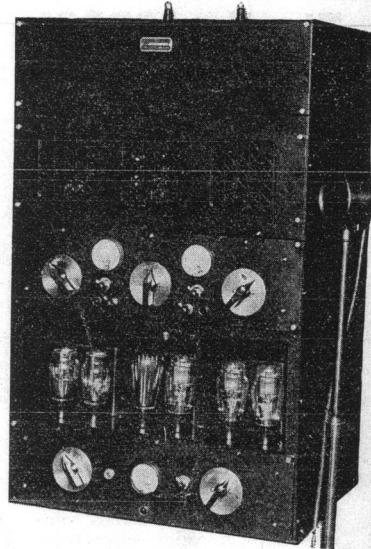

The Essential Variactor Unit Required for Controlled Carrier Modulation Is Now Available in Six Types to Take Care of Transmitters From 25 to 800 Watts Output.

### CV VARIACTORS FOR CONTROLLED CARRIER CLASS C

|   | List Price | Net to Hams  |
|---|------------|--------------|
| CV-1 25 to 50 watts maximum input controlled class C.....   | \$ 7.50    | <b>4.50</b>  |
| CV-2 50 to 100 watts maximum input controlled class C.....  | 10.00      | <b>6.00</b>  |
| CV-3 100 to 170 watts maximum input controlled class C..... | 15.00      | <b>9.00</b>  |
| CV-4 170 to 300 watts maximum input controlled class C..... | 20.00      | <b>12.00</b> |
| CV-5 300 to 500 watts maximum input controlled class C..... | 25.00      | <b>15.00</b> |
| CV-6 500 to 800 watts maximum input controlled class C..... | 33.00      | <b>19.80</b> |

### AV AUTOTRANSFORMERS FOR CV VARIACTORS—115/170 VOLTS AC

|                             | List    | Net           |
|-----------------------------|---------|---------------|
| AV-1 for use with CV-1..... | \$ 5.00 | <b>\$3.00</b> |
| AV-2 for use with CV-2..... | 6.00    | <b>3.60</b>   |
| AV-3 for use with CV-3..... | 7.00    | <b>4.20</b>   |
| AV-4 for use with CV-4..... | 9.00    | <b>5.40</b>   |
| AV-5 for use with CV-5..... | 12.00   | <b>7.20</b>   |
| AV-6 for use with CV-6..... | 15.00   | <b>9.00</b>   |

CV VARIACTORS are suitable for obtaining controlled carrier on any transmitter using high level plate modulation. For existing equipment the corresponding AV autotransformer must be used with the CV VARIACTOR.

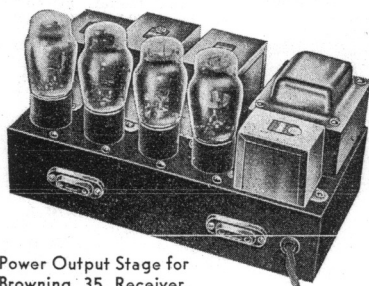

Power Output Stage for Browning 35 Receiver.

## HIGH POWER NIKLSHIELD OUTPUT STAGE FOR SMALL RECEIVERS

Designed Especially for the Browning 35 Receiver

18 Watts of Audio With 42's in a Prime Fixed Bias. Tubes Used 2-42's, 1-83V, 1-45 Bias Rectifier.

Complete Power Deck With All Transformers, Condensers, Resistors, Sockets, and Twin Jacks Fully Mounted and Ready to Wire. List Price \$26.00, Net to Hams \$15.60.

# UNITED TRANSFORMER CORP.

264-266 CANAL STREET

Export Division, 15 Laight St., New York, N. Y.

NEW YORK, N. Y.

Exclusive UTC distributors carrying a complete stock of UTC products.

|   |   |
|---|---|
| Goldhamer's, Inc. .... 610 Huron Road, Cleveland, Ohio                      | Marine Radio Co. .... 124-13 101st Avenue, Richmond Hill, N. Y.           |
| Wholesale Radio Service Co., Inc. .... 100 Sixth Ave., New York, N. Y.      | Hall's ..... 35 So. Cameron, Harrisburgh, Penna.                          |
| Wholesale Radio Service Co., Inc. .... 219 Central Ave., Newark, N. J.      | Cameradio Company ..... 603 Grant Street, Pittsburgh, Pa.                 |
| Wholesale Radio Service, Inc. .... 430 W. Peachtree St. N. W., Atlanta, Ga. | W. H. Edwards & Co. .... 32 Bway, Providence, R. I.                       |
| Sun Radio ..... 227 Fulton Street, New York, N. Y.                          | Seattle Radio Supply, Inc. .... 2319 Second Ave., Seattle, Wash.          |
| Gross Radio, Inc. .... 51 Vesey Street, New York City                       | Portland Radio Supply Co. .... 1300 W. Burnside, Portland, Ore.           |
| Leeds ..... 45 Vesey Street, New York City                                  | Spokane Radio Co., Inc. .... 611 First Ave., Spokane, Wash.               |
| William Gram ..... 1444 Sheridan St., Lansing, Mich.                        | San Francisco Radio Exchange ..... 1284 Market St., San Francisco, Calif. |
| Mohawk Electric Co. .... 1335 State St., Schenectady, N. Y.                 |   |
| Walter Ashe ..... 1100 Pine St., St. Louis, Mo.                             |   |
| Radio Shack ..... 46 Brattle St., Boston, Mass.                             |   |
| Harvey's Radio ..... 105 W. 43rd St., New York, N. Y.                       |   |
| United Radio Service ..... 616 Main St., New Bedford, Conn.                 |   |
| Nutter & Cross ..... 900 Milk St., Boston, Mass.                            |   |
| Hatry & Young ..... 203 Ann St., Hartford, Conn.                            |   |
|   | Pacific Radio Exchange Inc. .... 729 S. Main St., Los Angeles             |
|   | Radio Supply Co. .... 912-14 S. Broadway, Los Angeles                     |
|   | Coast Electric Co. .... 744 G. St., San Diego                             |
|   | Prest & Dean Radio Co. .... 400 American Avenue, Long Beach               |
|   | Radio Television Supply Co. .... 1701 S. Grand Ave., Los Angeles, Calif.  |
|   | Radio Specialties Co. .... 1516 West 8th St., Los Angeles, Calif.         |