

OHM'S LAW

$$E = I \times R$$

$$R = \frac{E}{I}$$

$$I = \frac{E}{R}$$

CONDENSERS IN SERIES

$$C_{TOTAL} = \frac{C_1 \times C_2}{C_1 + C_2}$$

RESISTANCES IN PARALLEL

$$R_{TOTAL} = \frac{R_1 \times R_2}{R_1 + R_2}$$

BOTTOM VIEWS OF SOCKETS

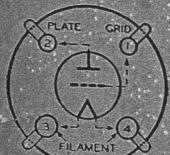

4-PRONG SOCKET
0-201-A, 45-210, 30, 31, ETC.

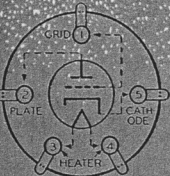

5-PRONG SOCKET
56-46-47-76-27-37
(Cathode is Screen Connection for '47)

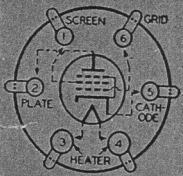

6-PRONG SOCKET
2A5-41-42-43

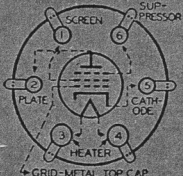

6-PRONG SOCKET
57-58-60G-60G-77-78

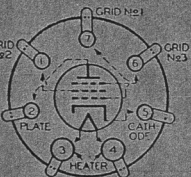

7-PRONG SOCKET 59

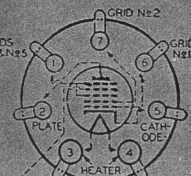

7-PRONG SOCKET
2A7-6A7

25c [30c in Canada]

DECEMBER, 1935

\$3.00 PER YEAR BY SUBSCRIPTION

RADIO

ESTABLISHED 1917

THE TECHNICAL AUTHORITY OF AMATEUR RADIO

- IN THIS ISSUE -

- ★ A Stable UHF Oscillator
- 30 Watt, 10 Meter Phone
- New Ultra-Short Wave Jones Receiver
- The New Armstrong Development
- 50 Watt Suppressor Modulated Phone



Model Phone-CW Station
Built by C. T. Stevens for
Dr. J. D. Coate, W6MYR-
ex-W9FIL. Completely
described in this issue.

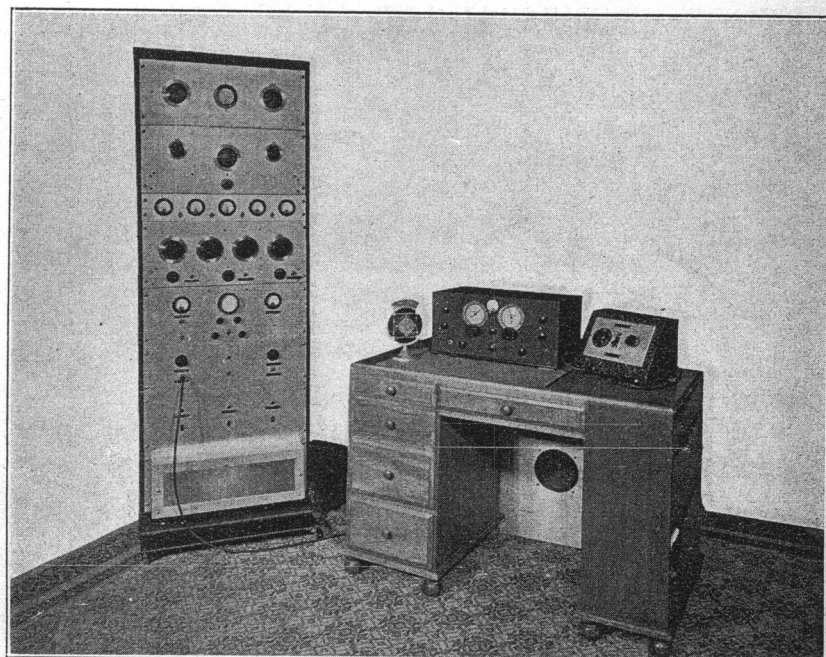

FEATURE ARTICLES BY ...

FRANK C. JONES
HERB. BECKER

- D. B. McGOWN
- FRANCIS CHURCHILL

- D. E. REPLOGLE
- ALICE R. BOURKE

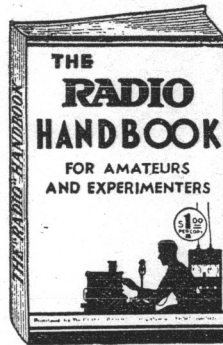

100,000 COPIES

Announcing Amateur Radio's Greatest Book — The 1936 Edition of "THE 'RADIO' HANDBOOK"

★ ★ The Technical Authority of Amateur Radio ★ ★

Absolutely Unbiased and Unprejudiced in Its Editorial Content.
Contains Many New Facts Not Found in Any Other Book!

Completely Re-written From Cover to Cover

MANY NEW CHAPTERS... 100 NEW CIRCUIT DIAGRAMS

TWO ENTIRELY NEW HOME-BUILT RECEIVERS ARE SHOWN

— SPECIAL OFFER —

● Send \$1.00 now and we will mail a copy of the 1936 edition of "The 'RADIO' Handbook" to you as soon as the ink is dry. Or—send \$2.00, get a copy of this new Handbook and a subscription to "RADIO" for *ONE ENTIRE YEAR!* If you are already a subscriber to "RADIO", your subscription will be *extended for one year.* Thus every reader of "RADIO" can save money by taking advantage of this great offer NOW! This offer will be withdrawn when the new Handbook comes off the press. 20,000 new subscribers to "RADIO" are wanted . . . be one of them, and save money in so doing.

A NEW edition of "The 'RADIO' Handbook" is on the press. It is a huge volume of information . . . containing *MORE* new facts, *more* new circuits than you will find in any other radio handbook. It has been rewritten from cover to cover; 100 new circuit diagrams are shown. New theories are propounded . . . theories which others will eventually use. For the Handbook by "RADIO" is the leader in the field. . . the accepted *Authority* of amateur radio. The first edition sold out within 90 days . . . and we thought we printed enough copies to last an entire year. Cablegrams from far-away places, ordering as many as 300 books at a time . . . orders from schools, colleges, radio clubs, ordering as many as 200 books at a time . . . orders from engineers, broadcast stations, government agencies, newspaper and magazine publishers, etc., helped swell the mighty total of copies sold. 18,000 unfilled orders on hand today . . . all received within 60 days previous to the writing of this advertisement, and each day the order log increases!

Stand by—for the greatest textbook the amateur has ever seen—the 1936 edition of "The 'RADIO' Handbook." The book for the teacher, for the student, for the library, for anybody who wants to learn many of the things about amateur radio *NOT FOUND IN ANY OTHER BOOK.* When you buy "The 'RADIO' Handbook" you get exactly what you pay for—*TECHNICAL FACTS.*

Publishers of "RADIO"
Pacific Bldg., San Francisco, California, U. S. A.

Here is \$1.00. Send me one copy of the 1936 edition of "The 'RADIO' Handbook" as soon as it is off the press.

Or—here is \$2.00. Send me one copy of the 1936 edition of "The 'RADIO' Handbook" and a subscription to "RADIO" for 1 year. I am am not (please indicate which) already a subscriber to "RADIO."

Name.....

Street and Number.....

City and State.....

Radio's Christmas Message

By EARLE ENNIS

Know then, O Tara, that this Thing called RADIO, that lights the trodden Paths of Men, is the Child of Silence and Slow Time! RADIO is a Song, sent winging by the Sun-God as he strums his gleaming copper Harp with unseen Fingers. RADIO is the Lightning-Bolt trapped within a Cage of Glass, held Prisoner by the gossamer Thread of Man's directed Will. RADIO is a Seed out of the interstellar Void from which, as from a Dragon's Tooth, springs Miracles full-fledged in the Panoply of Divine Array. RADIO is a Presence . . .

Look Thou, O Tara, RADIO is a Clown, wearing the Mask of Science. A Buffoon. A Mimic, pantomiming Gods we know not. A Maker of Quip and deadly Jest, whirling, spinning, gyrating upon Time's boundless Stage. We laugh. We cry. And it gibbers at Us and with Us. We applaud, and it falls to praying in mad Measure. In Its hollow Eyes sit the Dream and the Fear of Ages. And that which We witness is but the Shadow of That which lies behind the Curtain. Ho! RADIO, the Harlequin . . . God help Us!

O, Tara, hearest Thou not? RADIO is a Whisper through the Night. A Sigh of Hope breathed out of Nothingness, pulsing through Wind and Storm down the spiral Stairways of anxious Ears. It swirls with the Blast. It beats with the Rain. It drifts with the Clouds. It crests with the Spray. From Ice-packs to Equatorial Drifts. It haunts tense Mast-tips with sibilant Echoes. A Muted Voice out of Space, It talks to our Souls. Aye, e'en though They be hidden in the Four Corners, far from the Paths of Men! RADIO is the Mysterious One. The Omnipresent. The Inevitable. . . .

Ponder Thou this, O Tara, This RADIO, This God of Shadows, which yet has no Shadow, He is a Footstep in the Dark. A candle in dim Attics where Sickness, Poverty and Misery lurk like Spiders in the Gloom. There He comes, with Face alight, in shining Robe, unafraid throwing wide dull Windows to Life's Light and Air. RADIO is the Giver, the Renewer, the Great Physician. RADIO is a Star gleaming through the Dusk. God's blessing.

RADIO is Knowledge, O Tara, Wisdom. Energy. Power. It is a Symbol of the All, written in Letters of Fire, built in Walls of Stone, swinging in the Ocean's vast Clypsedra. It is the Moving Finger smudging out Man-made Boundaries of Race and Creed. The Cosmic Metronome marking the Rhythms of Centuries in flicking Light-Seconds that are but as Teeth on the Wheel of Time. RADIO is the Master Builder of ageless Temples dedicated to Truth, all-hidden, all-revealed.

See, Thou, O Tara, He is the Spirit of Christmas, coming incognito through the Days, weighing each and all, True and False. Kindly. Immutable. Friendly. Inscrutable. Great in His gentleness, mighty in His humility, is This Thing, O Tara, This Presence that lights the trodden Paths of Men. This Child of Silence and Slow Time. This Father of Twilight Messages. This Comforter of Deep Pain and Far Hungers. This Weaver of Dreams Incredible. See ye, O Tara, that ye guard and regard It well!

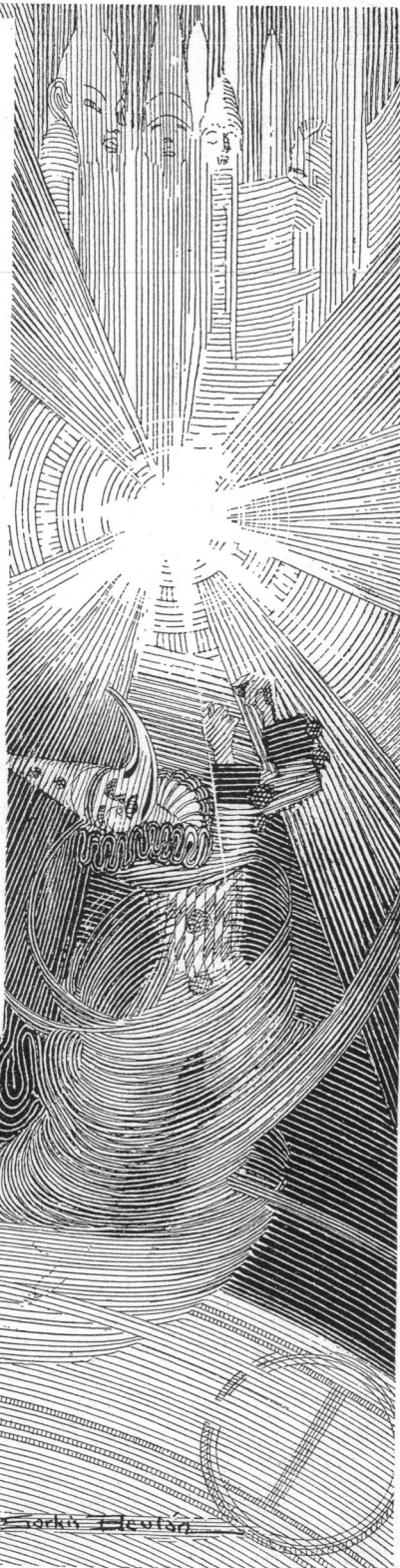

1000 Watts at 5 Meters with Amperex Carbon Anode Tubes

Specially Designed for Ultra High Frequency Operation

RATING AND DATA HF200

FILAMENT:
Voltage 10-11 Volts
Current 3.4 Amps.

GEOMETRIC CHARACTERISTICS:
Amplification Constant- 18
Inter-Electrode Capacities:
Grid to Plate 5.3 MMF.
Grid to Filament 5.2 MMF.
Plate to Filament 1.2 MMF.

MUTUAL CONDUCTANCE 5000
Micro-Mhos
at Plate Current of 150 MA.

MAXIMUM OPERATING RATINGS: when used as Class C
Oscillator or Power Amplifier
at frequency of 60 megacycles.
Allowable Plate Dissipation 150 Watts

2500 V. A. C.
Plate Voltage 2000 V. D. C.
Plate Current 200 MA.
D. C. Grid Current 60 MA.
D. C. Grid Bias Voltage 350 VOLTS
Attainable Plate Power Output 250 to 350 WATTS

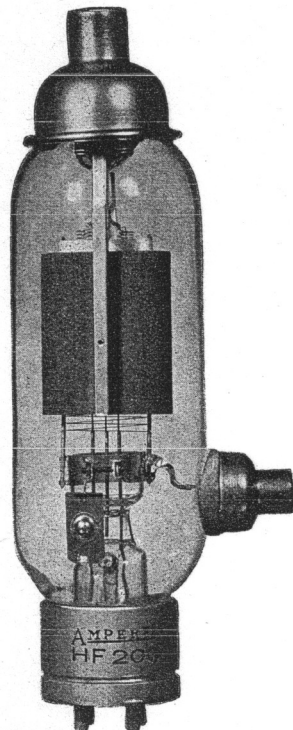

SUCH are the design characteristics and efficiency of the Amperex HF300 Tubes that in suitably designed circuits a pair of them will deliver a 1000 Watt Plate Power Output at 5 meters. Their remarkable performance has been made possible by the design characteristic which gives these tubes the distinct advantage of possessing the highest ratio of Transconductance to Interelectrode Capacitance yet attained in any tube. This characteristic in combination with their high mu reduces the requirements for grid excitation to a minimum.

These new Amperex tubes are proportioned along conventional lines. There is nothing freakish in their structure or appearance. In their design is incorporated the latest engineering practice and knowledge of ultra-high frequency operation.

Such has been the successful acceptance of the Amperex Ultra-High Frequency Tubes that some of the major competitive manufacturers have copied in detail their design and structure.

A partial list of Amperex tubes suitable for Amateur and Experimental work is listed below:

Watt Plate Power Output	
HF300 500	\$50.00
HF200 400	24.50
211-H 175	17.50
203-H 175	17.50
211-C 150	17.50
211-D 150	15.00
830-B 50	10.00
801 25	3.25
872-A Mercury Rectifier.....	17.50
866-A Mercury Rectifier.....	5.00

AMPEREX

Electronic Products, Inc.

79 Washington Street Brooklyn, N. Y.

West Coast Representatives

C. R. STRASSNER
1341 So. Hope St., Los Angeles, Calif.

R. C. JAMES, Jr.
Northwestern Agencies
Third Ave. & Vine St., Seattle, Wash.

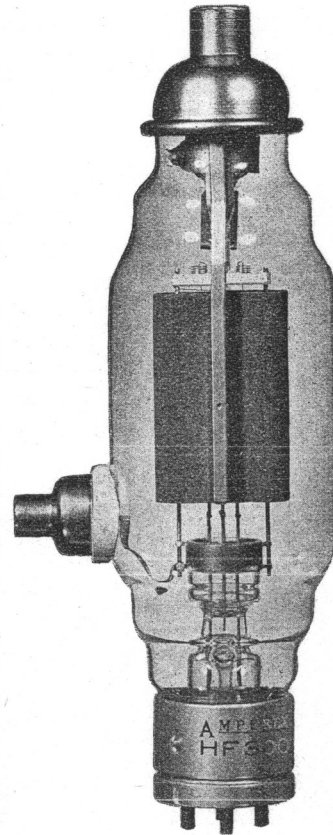

RATING AND DATA HF300

FILAMENT:
Voltage 11-12 VOLTS
Current 4 AMPS.

GEOMETRIC CHARACTERISTICS:
Amplification Constant- 23
Inter-Electrode Capacities:
Grid to Plate 6.5 MMF.
Grid to Filament 6.0 MMF.
Plate to Filament 1.4 MMF.

MUTUAL CONDUCTANCE 5600
Micro-Mhos
at Plate Current of 150 MA.

MAXIMUM OPERATING RATINGS: when used as Class C
Oscillator or Power Amplifier
at frequency of 60 megacycles.
Allowable Plate Dissipation 200 WATTS

3000 V. A. C.
Plate Voltage 2200 V. D. C.
Plate Current 275 MA.
D. C. Grid Current 75 MA.
D. C. Grid Bias Voltage 400 VOLTS
Attainable Plate Power Output 400 to 600 WATTS

BRANCH OFFICES:

New York City,
253 W. 128th St.
Tel. MOnument 2-2812

Boston,

J. H. Condon,
6 Marlboro St.

Chicago,

C. W. Nelson,
3618 North Bernard St.

RADIO

ESTABLISHED 1917

Reg. U. S. Pat. Off.

A NATIONAL MAGAZINE - PUBLISHED MONTHLY

Publication Offices—Pacific Building, San Francisco, California

H. W. Dickow, Publisher.

D. B. McGown, Technical Editor.

Frank C. Jones, Engineering Editor.

C. C. Anderson, Engineering Draftsman

25c per copy, \$3.00 per year by subscription in the U. S. \$4.00 elsewhere. Send subscriptions to the San Francisco office. Entered as second class matter at the Post Office at San Francisco, California, under the Act of March 3rd, 1879.

Vol. 17

DECEMBER, 1935

No. 12

Radiotorial Comment

Greetings To Canadian Amateurs

● Effective January 1, 1936, the tariff of 5c per copy of "RADIO" going into Canada is abolished. The Canadian subscription price is reduced to \$3.00 per year. The many Canadians who subscribed to "RADIO" at the \$4.00 price will have their subscriptions automatically extended. Both RADIO and the Canadian readers come out ahead. The abolition of the tariff will enable RADIO to print more copies, buy more paper, give employment to more people. Canadian news wholesalers who clamored for copies will again receive them for the first time in several years. Under the provisions of the old tariff, a 5c duty stamp was affixed to copies of RADIO going to Canadian news wholesalers. Unsold copies, taxed 5c each, made it unprofitable for us to ship large quantities of magazines into Canada "on a flyer". If, for example, 500 copies were shipped to a wholesaler, and 100 copies remained unsold, these "returns and allowances", taxed at 5c each, would have absorbed the profit on the entire shipment of magazines to the wholesaler. Thus RADIO was sold to the trade on a "clean sale" basis, and only the sure-fire jobbers were supplied with copies. Hereafter it will be possible for any Canadian amateur to secure copies of the magazine. If your dealer don't stock it, send us his name, and we will see to it that he is supplied. Thus the new tariff is a welcome bit of news for you and for us. Shake, Brother Canuck!

DeSoto Over a Barrel

● To what lengths must a man go in order to save his job? How long will the radio amateur sit idly by and swallow the bitter pill of misinformation prescribed by Clinton DeSoto of the American Radio Relay League? The recent charge of DeSoto should not go unchallenged. DeSoto claimed that RADIO is largely owned and controlled by Colonel Foster. A sworn statement, signed by the publisher for the United States Post Office Department, reprinted elsewhere in these pages, is proof that the magazine is owned solely by the same person who founded it 18 years ago. Take your choice . . . the statement to the Government, or the DeSoto charge! A letter was sent to DeSoto asking him to show proof that the Colonel largely owned and controlled RADIO. Of course, DeSoto cannot supply these facts, because they do not exist. We thought DeSoto would apologize for the lie he wrote. But our letter remains unanswered. DeSoto holds a prominent position in the amateur's league . . . a position of honesty, of trust! DeSoto wrote a grievous mis-statement of fact. He's in a corner. Let's keep him there until he admits that he knew not what he was talking about . . . or apologizes for a gross misrepresentation of fact. The Colonel is no longer here to give the lie to the charge . . . nor to force DeSoto to play his hand. Let's you and I do it, Brother Ham! A principle is at stake.

● ● ●

Another Birthday

Next month this magazine begins its nineteenth year of publication. It has been published regularly since 1917, except for "time out" when Uncle Sam engaged in the World War. All of those who were with "RADIO" volunteered for service. One was an Engineer Officer on a destroyer, another a Radio Inspector at a Navy Yard; another went with General Squier at Washington, and another was in charge of a Naval Radio Station far from home. Their names? Who cares!

Those still with "RADIO" are dyed-in-the-wool hams of the old school. Some had "ham" stations in 1907. Those were the days when we told the commercial operators what we thought of their operating. We relayed traffic for them, and we called them on the telephone when we heard signals they couldn't hear. One showed his appreciation by throwing rocks at a young "ham" when he walked up the hill atop of which a commercial station was located. His hobby was to "scare the kids." He would call them on the telephone, invite them to inspect the station. Under the operating table was an apple box filled with cobble-stones. When the suspect came walking up the hill, out came the ammunition, and the poor "ham" would run like hell. I speak from fact, because it was none other than I who once was on the receiving end of the stone barrage.

We had the edge on the commercials in those days; radio laws were unheard of. We made and broke our own laws. Those were the days, believe it or not, when the vessels of the old Pacific Mail Line worked San Francisco direct from Yokohama with a spark transmitter at one end, a crystal detector on the other. Anyone who held a "Certificate of Skill" could get a job as a wireless operator on a steamship, a boat or a tub. The wireless examination was orally given. Four or five questions were asked. An example: Question (1)—"You are applying for a Certificate of Skill as Wireless Operator. In order to qualify, you must first answer this question—Your station is in perfect shape. Absolutely nothing is wrong. I repeat—all of the equipment is in perfect operating condition. Yet you cannot hear a single station. Why?"

This question was asked of some who applied for the Certificate of Skill. Many failed to answer it correctly. Do you know why the operator didn't hear a single station, even though his equipment was in perfect operating condition? Write your answer to this damphool question on a post-card, send it to the editor, and a list of names of "suc-

cessful applicants" will be printed in these columns next month.

Certificate in hand, you made yourself known at the offices of the "Wireless Telegraph" company. You were usually given an assignment on the same day. If you quit, resigned, got fired or suspended at 9 in the morning, you were hired back before 5 in the afternoon. Don't disturb me, folks, I'm reminiscing. I'm thinking of the good, old days . . . when hams were men and Madrid Treaties unknown. We had no board of directors to vote against our wishes. Coming to think of it, bigosh, we didn't even have Warner!!!!

RST Merges With QSA-R

● When a doctor makes a mistake he buries it.

Not so with some of the die-hards of amateur radio, particularly those who have so lustily touted the remnants of the almost defunct RST system of readability, signal strength and tone.

Many were the letters which reached the editor's desk, pleading with him to denounce the new-deal RST report. Two letters came from QSL card printers who happened to have a large stock of ready-printed QSA-R cards on hand which carried the fill-in space to complete the report. It seems that these printers merely imprint, in a second color, the call letters of the station which orders a stock of cards, and with the RST system spelling ultimate financial disaster and ruin for those who had invested ten dollars (or less) in printed stock cards, they wanted us to do something about the RST system. "Stop it," one printer wrote.

It served no useful purpose. There was no need to upset the old reliable QSA-R applicator. The QSL card printers didn't stop it—it stopped itself. Average John Ham didn't like it.

Let's look the facts squarely into the eye and stop kidding ourselves. In the first place, there wasn't anything fundamentally wrong with the QSA-R system. Amateurs knew it like they know their A-B-Cs. Speed-burners and DX men even cut corners from the QSA-R system, and rightfully so. You've heard 'em? Here's how they come back: "5-7," or "4-6" . . . leaving off the QSA and the R portion of the signal. All the useful information is contained in those two figures. "5-9" is tops . . . "1-1" is cause for alarm. If 5 denotes maximum in QSAs, and 9 denotes maximum in Rs, why hang a QSA and an R on the signal, anyway? Can you picture a DX hound at the other end of the world twiddling his time away on needless characters? 5-7, 3-8, or any other combination is all he wants to hear, all he wants to tell. A QSL card does the rest. No time to waste

(Continued on page 24)

Phase-Frequency Modulation*

Major Armstrong Discloses His New Development

● Major E. H. Armstrong reveals to I.R.E. members the details of his new system, in which phase multiplication plays a leading role, and by which the ultra-high frequencies may be used over much greater distances and with less noise interference.

● Since April, 1935, when E. H. Armstrong announced to the press that he had a successful system of radio transmission by means of a frequency-modulated wave, details have been anxiously awaited. They were supplied at the November meeting of the Institute of Radio Engineers on November 6th. From the contents of that paper, and from an interview with Mr. Armstrong, "Electronics" has prepared the following review for the benefit of those who did not attend the New York meeting. The complete paper will appear in the Proceedings of the I.R.E.

Of primary interest are the results achieved. Briefly they may be stated as follows: Using the two-kilowatt 41-MC transmitter of the NBC on the Empire State Building in New York City, frequency-modulated signals covering a total band-width of 150 KC were sent to a specially constructed superheterodyne in Haddonfield, N. J. (near Philadelphia) 85 miles away, consistently for more than a year. Comparison of the quality and strength of the signals received were made with several 50 KW broadcast stations operating between 600 and 900 KC near New York. On numerous occasions it was possible to make comparisons using the same program, since the Empire State transmitter had access to NBC programs which were being transmitted by WJZ and WEAJ. Under good atmospheric conditions, the frequency-modulated transmissions were distinctly superior, and under adverse conditions of noise and static, the frequency-modulated signals were clearly audible when the broadcast stations could not be picked up at all. On several occasions during severe thunderstorms, the frequency-modulated signals from 85 miles away could be heard more plainly than those from WCAU, a 50 KW station only 20 miles away.

Frequency modulation differs from the universally used amplitude modulation in that the amplitude of the emitted frequencies remains constant regardless of the depth of modulation or of the value of modulation frequency, while the carrier is caused to shift in frequency by an amount proportional to the depth of modulation and at a rate corresponding to the modulation frequency. In the apparatus described by Mr. Armstrong, for example, the carrier frequency deviated from its normal position by 75 KC on either side of the 41 MC center under full modulation, and this deviation occurred 5,000 times per second when the modulation frequency was 5,000 cps.

One advantage of such transmissions is the fact that the transmitter is always operating at optimum efficiency (full output of the final amplifier), whereas in amplitude modulation the peak power is four times the unmodulated power, with attendant requirements for tubes and power supply. The disadvantages are the apparent complexity of the transmitter and receiver, and the wide frequency band required. It is to be remarked that the degree of frequencies modu-

lation employed in the FM system is consistently less than that inadvertently introduced by almost all self-excited amateur transmitters now using "amplitude" modulation on the 60 MC (5 meter) band.

The complexity of the transmitter cannot be gainsaid; it contains, (in addition to a crystal oscillator, balanced modulators, and amplifiers) no less than 10 multiplying stages and 6 buffer-filter stages. The original receiver contained three RF (41 MC) stages, followed by a converter to 6 MC, followed

with its variable phase angle is then fed to a series of frequency multipliers which multiply the frequency and its phase shift at the same time. After multiplication to 41 MC, the phase angle is large enough to cause 100% frequency modulation for the highest modulation frequency, corresponding to a 75 KC deviation on either side of the carrier or 150 KC total band-width.

It is to be noted that if the phase shift were not inversely proportional to the modulation frequency, the final frequency devia-

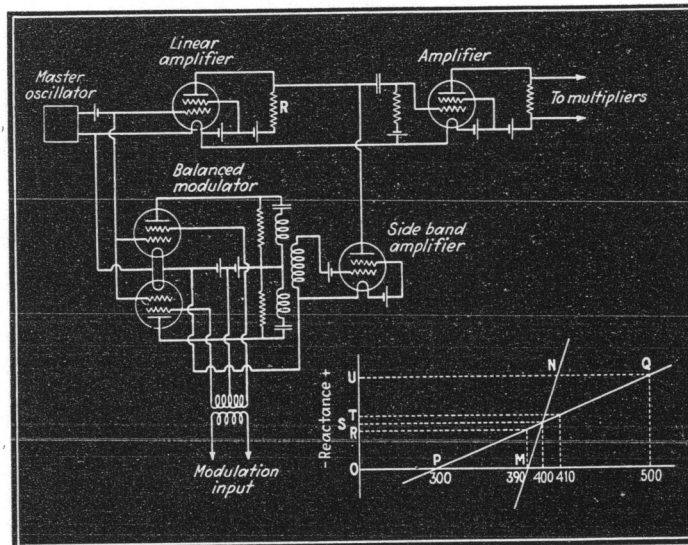

Fig. 1—Diagram of the phase-changing apparatus in the transmitter. Insert—diagrammatic analysis of the anti-noise action

by an IF gain of 2,000, followed by a second conversion to 400 KC, followed by a second IF gain of 1,000, followed by current limiters, conversion amplifiers and rectifiers, and the audio output stages. Later, by the use of an acorn tube in the RF, two tubes were eliminated, leaving a total of approximately 25. Mr. Armstrong believes that further simplification can be secured, and reminds old timers that the original superheterodyne had 37 controls, which have since been happily reduced (in the case of the cigar-box midget) to about 0.5.

The Transmitter Problem

According to the paper, "During the course of this work there was evolved a method which, it is believed, is a complete solution of the transmitter problem." This involved (1) stable central frequency ("carrier" or "unmodulated" frequency); (2) frequency deviation independent of modulation frequency, but proportional to the latter's amplitude; (3) linearity throughout; (4) the use of aperiodic circuits to eliminate resonance troubles; (5) the achievement of frequency deviations of the order of 200 KC without violating any of the foregoing conditions.

The solution of this formidable array of requirements was found by the use of a small phase shift produced in the output of a constant-frequency oscillator. This phase shift, not more than 30° maximum, is made proportional to the amplitude of modulating current, and, for reasons given below, also inversely proportional to the modulating frequency. The constant-frequency oscillation

would be proportional to the modulation frequency, which is a violation of requirement (2), above. The inverse proportionality in the phase shift produces independence of modulation frequency in the frequency deviation of the emitted signal. The phase shift is made inversely proportional to modulation frequency by the use of a condenser shunted across the grid of the speech amplifier, used in conjunction with a series resistor.

The phase shift apparatus (Fig. 1) follows: The output of an oscillator (50 to 100 KC crystal-controlled) is fed to a linear amplifier and to the grids of a balanced modulator. The modulator is suppressor modulated by the speech input. The output of the balanced modulator contains the sidebands (oscillator frequency plus and minus modulation frequency). These are then given a 90° phase shift through the output transformer, amplified and returned to resistor R, common to the side-band amplifier and the linear amplifier. The voltage across this common plate resistor R has the master frequency and a phase which is proportional to the side-band (modulation) amplitude, and, by the mechanism explained above, inversely proportional to the modulation frequency. An isolating amplifier feeds this voltage to the cascaded doublers, which proceed to multiply the frequency and phase by several thousand times. This multiplication process is not critical or unstable, and no great linearity precautions need be taken.

Spurious frequencies must be eliminated at each multiplication, hence the need for buf-

* This article reprinted from November "Electronics" by special permission to "RADIO".

fer-filter stages, but otherwise the process is completely straight-forward.

All of the tubes used in this setup, except the last four or five stages, are receiving tubes. The reduction of cost thereby introduced is considerable, there being no less than 73 tubes in the transmitter, as used for multiplex work. But 73 tubes, or no, a "complete solution" of the transmitter has been achieved therein. The transmitter, considering its complexity, is a miracle of stability.

The Receiver Problem

A major difficulty lay in the design of a receiver to translate the frequency modulation into amplitude modulation, with high fidelity, and without admitting noise. Two alternative methods of achieving this end have been developed, both of which operate on the same essential principle. For the sake of simplicity, only one will be described. The received signal (picked up on a half-wave vertical dipole antenna) is fed through RF amplifiers and two wide-band (150 KC) IF amplifiers of 6 and 0.4 MC frequency. The input of the final IF amplifier is fed to the conversion circuit (Fig. 2). The combinations of resistances, inductance and condensers R , L , C , and R' , L' , C' convert the imposed frequency modulations into amplitude modulations by the clever expedient of having L and C resonant at the lower limit F_1 of the 150-KC IF band-pass, while L' and C' resonate at the upper end of F_2 of the band. The resistances R and R' are large enough to make the current in each branch substantially constant over the frequency band. Under such conditions, the reactance across each branch is given by A and B in Fig. 2. Because of the constant current, the voltage across this reactance is thus given by A' and B' also in Fig. 2. It will be seen that the voltage has the required change in amplitude as the frequency is varied from F_0 on either side to F_1 and F_2 . This voltage is fed through amplifiers to linear rectifiers. The outputs of the rectifiers are connected in the proper polarity so that current changes produced by frequency changes are added. The net rectifier current is then coupled to a suitable audio system for loudspeaker reproduction.

Current-limiting devices (a.v.c.) are incorporated in the receiver for the double purpose of aiding the anti-noise action, and providing a constant level. Fading was quite noticeable over the 85 mile path but selective fading was not observed, so that the a.v.c. held the level constant without distortion. The quality of the circuit can be realized from the fact that when the telephone lines from the studio to the Empire State transmitter were compensated to 13,000cps., the quality of reproduction from a loudspeaker at the receiving end was then substantially better than that obtainable on a high-fidelity receiver from any regular broadcast station.

The system has been used for some time as a multiplex circuit, both the Red and Blue network programs being sent simultaneously on the same channel without difficulty. Multiplexing requires a wider channel than simplex transmission, but no great difficulty was found in handling a modulation range of 30,000 cps., for multiplex purposes.

Why the Signal-to-Noise Improvement?

The fact that a practical frequency modulation system has been devised and that it permits an improvement in some respects over amplitude modulation methods, at least on the ultra-high frequencies, would be in itself sufficient justification for the report were it not for the extraordinary interest in

the effect of the new system on the signal-to-noise ratio. This interest has arisen partly because of the practical nature of results obtained, but mostly because the results are a contradiction of the long-accepted theory that the noise received is proportional to the band-width received. This theory has been substantiated by amplitude-modulation receivers. It is clear, however, that in the last analysis, only audible noise (as high as 20,000cps.) is troublesome. Thus as the received band is widened, the audible noise reaches a limit. When the band is 20 KC wide, the

This analysis proceeds from the assumption that the carrier is stronger than the noise. In quiet locations (no ignition interference), shot noise and thermal agitation become the limiting factors. Discrimination against this type of noise has been carefully measured; under comparable conditions, a FM carrier on 41 MC with a 150 KC bandwidth produced an energy of signal 1,100 times greater in relation to the noise than did a 7.5 KC amplitude-modulated channel. Experiments with ignition interference were not so thorough or systematic, but it was

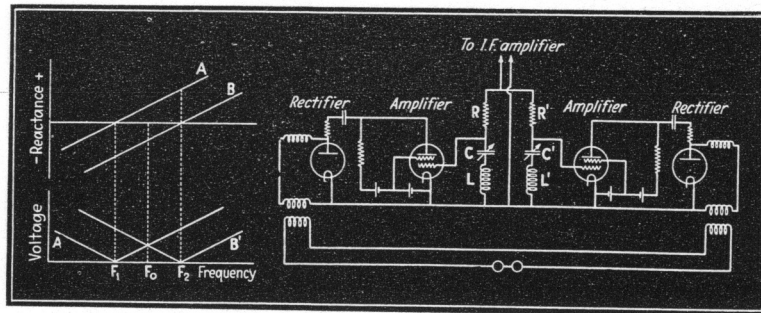

Fig. 2—Conversion circuit of the receiver (converts frequency variations to amplitude variations). Left, the frequency characteristics of R, L, C and R', L', C'

highest frequency (beats between the limits of the band) is 20 KC. Increasing the band width beyond this point does not increase the audible noise. Hence the 150 KC band used in the Armstrong system could contribute no more audible noise than a 20 KC amplitude-modulated channel. Actually it contributes considerably less noise.

To use Armstrong's words, "The basis of the method (of improving signal-to-noise ratio) consists in introducing into the transmitted wave a characteristic which cannot be reproduced in disturbances of natural origin and utilizing a receiving means which is substantially not responsive to currents resulting from the ordinary types of disturbance and fully responsive only to the type of wave which has the special characteristic.

The insert in Fig. 1 is the key to the noise problem. Suppose the selective system (Fig. 2) has a slope MN so that 100 per cent modulation is produced by a frequency shift of 10 KC either side of the 400 KC carrier. Noise components of frequency 390 and 410 will be zero and proportional to UO , respectively, their difference being UO . Now if a wider band is used, with a selective circuit of slope PQ , the noise components of frequency 390 and 410 will be but little different from the 400 KC carrier. The difference in value of the two noise frequencies is proportional to RT . Hence the noise produced with slope PQ will be related to the noise produced with slope MN as RT/UO , or 10 per cent for the values given in this case. The power ratio is 1 per cent. Thus, the wider the band over which the system operates, the less the noise in relation to the signal which is always UO . It is necessary for the noise components at 390 and 410 cps. to be opposite in phase; this requirement is met by the current limiting circuit which precedes the selective system, and which produces the 410 component as an "image" for the 390 component. Noise frequencies more widely removed from the carrier will not have as good a correction, but these are above the audible limit, and may be removed with filters without loss of fidelity. The same analysis holds true when the 400 KC carrier frequency is varied according to the modulation at the transmitter.

found that the peaks of this transient type of noise are often comparable with the signal, and that the noise discrimination is then not nearly so effective. But with cars within 40 feet of the dipole antenna, complete suppression of the noise was achieved with a signal (generated locally) 10 times the field strength of the Empire State Signal.

At the demonstration given at the I. R. E. Meeting, frequency-modulated signals from W2AG a 100 watt station in Yonkers, N. Y. (about 20 miles away) were picked up with an FM receiver installed near the speaker's platform. The transmitter, at the home of C. R. Runyon, on 2.5 meters (120 MC) had a frequency modulation band of 100 KC. Lantern slides showing the apparatus used at the transmitter were thrown on the screen before the audience at the same time that a description of the transmitter was being received from Yonkers. The result was a very convincing demonstration of the new system. The quality of reproduction was as good as that of the best broadcast stations, and the interference level, produced by a noise-infested city area, was very low.

In addition to this demonstration, a sound-film record of reception at the Haddonfield location was reproduced. It contained samples of reception from the FM transmitter on the Empire State Building, and the broadcast station WEAJ, operating on 660 KC with 50 KW, and also with station WMCA, a station which draws about the same power from the supply mains as does the FM transmitter. All the FM transmissions were reproduced with only a trace of background noise, and with good quality, while the signals from WEAJ were so marred by static from a thunderstorm within 20 miles of Haddonfield that only occasional words could be heard. The signals from WMCA were almost complete below the static and tube noises.

It was made clear by Major Armstrong that the paper is to be viewed primarily as revealing a new radio signalling device, by which frequency modulation over wide bands at short wavelengths makes possible a considerable reduction of noise from all sources. The apparatus and methods used are merely incidentals to attaining this end,

★ Stable U. H. F. Oscillators

By FRANK C. JONES

● The circuit here shown is not new, but its adjustments and physical makeup provide a very stable oscillator. The frequency stability is comparable to that obtained with quarter wave parallel rod oscillators, and the system illustrated does not require much space.

The grid RF excitation in this circuit can be controlled so as to provide good oscillator stability. The condensers C1 and C2 in Fig. 1 are formed of three heavy aluminum plates, mounted on small stand-off insulators. A moderate antenna load, controlled grid excitation, and a combination of grid leak and cathode resistor grid bias make this circuit remarkably free from frequency modulation effects.

Changing the DC plate voltage from 375 down to 150 volts and up again to 600 volts, did not change the frequency as checked by zero beat against a CW frequency-monitor meter by more than about 10 to 15 KC at 60 megacycles. The usual 5 meter oscillator will shift from 40 to 200 KC with this variation in plate voltage. With voice modulation, the plate voltage is varied over this range for moderately high values of modulation percentage. A properly adjusted parallel rod oscillator gave about 10 to 15 KC frequency change in similar tests. The frequency modulation even with parallel rod oscillators is often quite great in practice, because there is a tendency to adjust the grid taps for maximum antenna power rather than for maximum frequency stability. The same may hold true for this circuit if it is tuned for maximum output.

Very good frequency stability with a rigid antenna can be obtained if the antenna current is reduced 10 per cent to 20 per cent from the maximum obtainable with this circuit. This adjustment is made by varying the link coupling to a tuned circuit connected across the antenna feeders, or by variation of direct electro-magnetic coupling between the oscillator and antenna coils. The grid capacity C1 should be set to a value which begins to reduce the obtainable RF output. Tuning adjustments are made by plate bending and coil turn or length changes. The tuning is not as flexible as when regular variable condensers are used, but this convenience can be sacrificed for the stability obtained. Good stability means that better and more selective receivers can be used for ultra-short wave reception.

A high or low power 2½, 5, or 10 meter oscillator can be built very economically by using this system. The size of the plates and relative spacings shown are suitable for tubes up to 801's. With some types of tubes no cathode resistor and no high capacity audio by-pass condenser would be needed. The 400 ohm 10 watt resistor and 5 mfd. condenser were found to be essential with a 45 tube in order to prevent the plate current from creeping or increasing to high values when the tube was prevented from oscillating. With this resistor, 50 per cent higher plate voltage could be applied safely to either a 45 or 2A3 five meter oscillator.

Since a carbon 100,000 ohm resistor was used with the low mu 45 tube, no grid RF choke was needed. The RF choke for supplying plate current is made by winding about 75 turns of small wire on a ¼-in. diameter rod, the latter being removed after winding the coil. The supporting rod could be left inside the RF choke coil. The oscillator coil itself is provided with soldering-lug terminals so as to allow easy band change.

The condenser C2 is made of two 3-in. x 3½-in. No. 12 gauge aluminum plates, spaced

¼-in. apart. The extra half-inch length is used to provide mounting lugs for fastening to small stand-off insulators. The grid condenser C1 consists of a similar plate, 2-in. x 3½-in., spaced about ⅛-in. from the "floating" plate of C2. The other, or op-

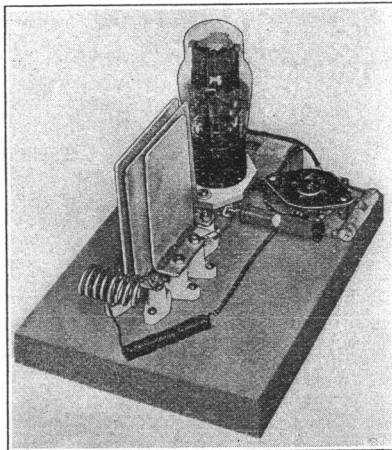

Stable Oscillator, showing extreme simplicity of construction.

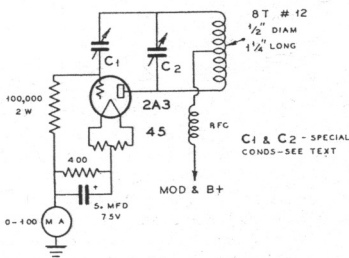

FIG. 1—Circuit for unit in photo above.

posite, plate of C2 of course connects to the plate. All leads are very short in this arrangement. Plate spacing can be varied by means of oblong slots in the mounting lugs, or feet, for rough adjustments. Closer adjustment is made by bending the upper ends of the plates and by varying the coil spacing between turns.

A 2A3 tube was run at 80 to 110 MA of plate current at 400 volts supply without overheating. A 45 tube was run at about 60 MA at 375 volts supply, and during tests the plate voltage was run up to over 600 with approximate outputs of 10 to 20 watts. Under conditions of modulation, a 45 tube should not be run at much over 300 volts DC supply. A 53 Class B modulator, or a pair of 2A5 tubes in parallel or push-pull, will modulate the 45 oscillator.

A high degree of stability in a modulated

oscillator means better voice quality, as well as less band width for each transmitter. The crowded condition in some localities on bands below 10 meters means that improvements in both transmitters and receivers are needed. The system shown is an economical and space-saving suggestion for improvement.

High Power 5 Meter Transmitters Using 50T Tubes

● Some interesting results have been secured with circuits using type 50T at relatively high power. These tubes have the grid and plate leads on the sides and tops, resulting in a tube construction which is ideal for ultra-high frequency operation. The plate dissipation is rated at 75 watts per tube, and outputs of more than a quarter kilowatt are obtainable below 10 meters.

All other available tubes have too much inter-electrode capacity for best stability in 5 meter circuits. For tuned-grid-tuned-plate oscillators, some method must be used to control the amount of RF grid excitation if good stability and long tube life is desired. The method here shown uses push-pull 50T oscillators with the grids tapped across only part of the tuned grid circuit.

This allows the grid tuning circuit to actually become the frequency controlling circuit instead of just a grid excitation control. In this case, the plate circuit should be low C, tuned as in any neutralized amplifier for best efficiency. The grid circuit is fairly high C in order to gain stability. The grids are tapped across only enough turns to obtain oscillation, resulting in relatively sharp tuning of the grid and plate circuits.

The principle advantage of frequency control in the grid circuit of this push-pull oscillator is that the antenna swinging effect does not directly act upon the frequency control circuit. The power is low in this grid circuit and double spaced midjet split-stator tuning condenser can be used without danger of flashover, even at plate voltages as high as 2500 volts DC. The plate condenser, being of low C, can be made from a pair of parallel 12 ga. aluminum plates, spaced from ½-in. to 1-in. apart. These plates are about 3-in. on a side, mounted at one corner on a stand-off insulator. The top end of each plate is connected to the plate cap of the tube closest to it, thus the plate leads were very short. A better mechanical mounting could be made by using two stand-off insulators to support each plate.

The frequency stability with wide change in plate voltage proved to be very good when the grid lead taps were across only a small part of the total grid coil. Moderate values of antenna load should be used. The stability is good enough for direct modulation for operation below 10 meters. It is more compact than a parallel rod oscillator and has almost the same stability and efficiency.

Either this circuit or the single tube oscillator shown in Fig. 2 of the M.O.P.A. set are suitable for use in diathermy oscillators. The

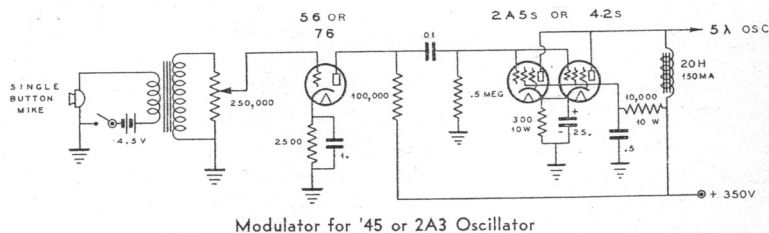

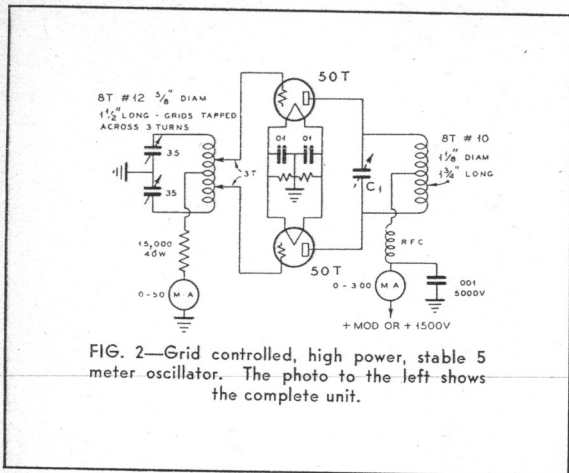
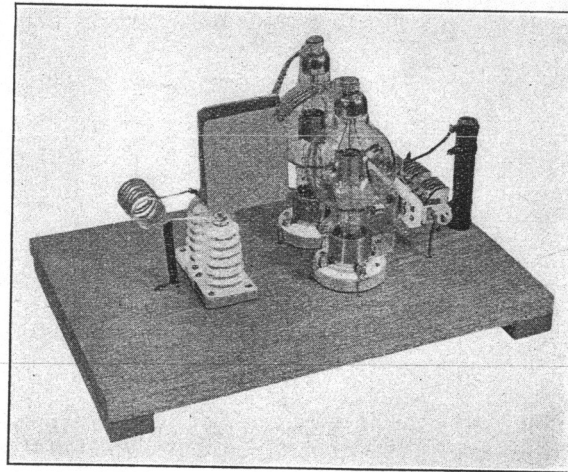

FIG. 2—Grid controlled, high power, stable 5 meter oscillator. The photo to the left shows the complete unit.



grid excitation control prevents overheating of the grid leads or caps, thus preventing tube failures. No excess heating was noticed when operating the push-pull oscillator at 2500 volts and 180 to 200 MA of plate current (inputs of between 450 and 500 watts). 100 watt lamps were used for RF loads in these tests. The single tube oscillator circuit shown could be used with a larger tube for high power diathermy sets in the event that several hundred watts output is required.

The single tube oscillator with a 50T tube uses the circuit with the 45 tube oscillator, described on the facing page. Larger plates were needed, about 4-in. x 4-in., since greater plate spacing is required for higher power. The capacity in mmfd. can be calculated for this type of condenser from

$$C = \frac{.225A}{d}$$

where A is the area in square

inches and d is the spacing between plates. About 3/8-in. spacing is used between the two plates tuning the oscillator LC circuit in Fig. 2 of the M.O.P.A. set. The grid coupling plate is 3-in. x 4-in. in area with nearly 1/2-in. spacing to the tuning condenser plate. 20 gauge copper plates were first used for this condenser, but mechanical vibration caused a ripple in the beat note test of carrier frequency. Thick aluminum plates minimized this trouble, and No. 12 or 10 gauge was found to be satisfactory. Copper would provide less RF resistance, but the plates would have to be thick and soft in order to prevent vibration.

The push-pull 50T oscillator was rebuilt into a neutralized RF amplifier by adding two neutralizing condensers and increasing the grid coil inductance for lower C operation. The 50T tubes neutralized very easily and thoroughly with less capacity than was anticipated. As can be seen from the photograph, the neutralizing condenser plates are widely separated. These neutralizing condensers can be two 1-in. x 1/2-in. plates,

the "stators" can be shifted by means of a pair of pliers while the "rotor" is fixed in position midway between the other two vertical plates. Since this amplifier was driven by link coupling to a 5 meter oscillator, the two grid leads were connected across the entire grid tank circuit.

With 1250 volts applied to the 50T oscillator in the M.O.P.A., the oscillator plate current ran about 100 MA under load. Link-

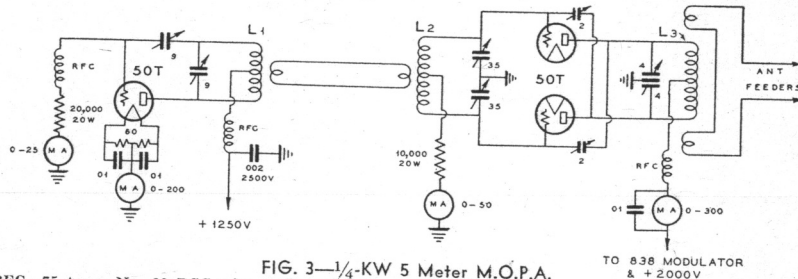

FIG. 3—1/4-KW 5 Meter M.O.P.A.
 RFC—75 turns No. 22 DSC wire, 1/4" or 3/8" dia.
 L1—7 turns No. 10 wire, 1 1/2" long, 3/8" dia.
 L2—8 turns No. 12 wire, 1 1/8" long, 3/4" dia.
 L3—8 turns No. 10 wire, 1 3/4" long, 1 1/8" dia.

separated nearly 1/2-in. The plates, connecting through crossed-over leads to the grids, are mounted on heavy Johnson coil jacks and stand-off insulators. This allows an easy adjustment of capacity when neutralizing. Other mechanical ideas could be easily worked out for a neutralized amplifier.

The plate condenser has a center grounded plate screwed directly to the hardwood baseboard in order to obtain a split-stator connection with grounded "rotor". In this case,

coupling to the neutralized amplifier using a pair of the same tubes gave a grid current of from 35 to 40 MA through a 10,000 ohm grid leak. The plate current of the amplifier depended upon the plate voltage and antenna load used.

With no antenna load, and plate voltage of 1800, an arc 1 1/2-in. long could be pulled from the plate tank condenser with a lead pencil as a test electrode. At 2700 volts, a

(Continued on page 14)

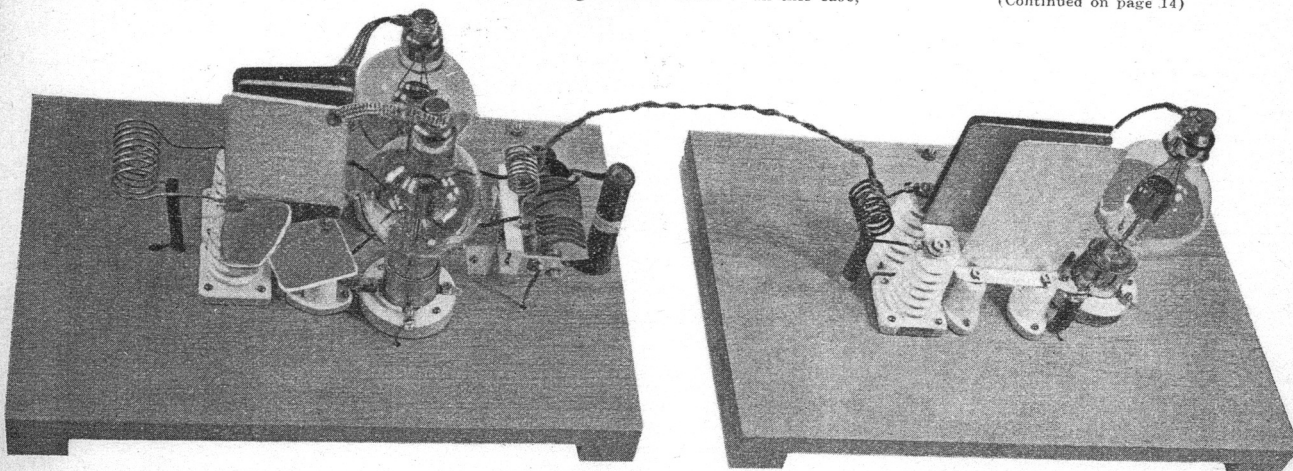

1/4-KW Stable Oscillator and Amplifier using 50T tubes.

A DeLuxe Amateur Transmitter

20 and 75 Meter Phone—20, 40, 80 CW Operation

By C. T. STEVENS

• The illustration shows a rear view of the relay rack transmitter illustrated on the front cover of this issue. It was designed and built for Dr. J. D. Choate, W6MVR-ex-W9FIL. Many of the doctor's old friends reside in the East and he desired to communicate with them by amateur radio. It was decided to use 400 watts of power in order to make reasonably sure that the transmitter would reach out in the 20, 40 and 80 meter bands. Class B modulation was finally chosen for the audio channel.

The circuit diagram shows that the Jones exciter is used. A 2 gang, 2 point switch cuts out the second section of the 53 when straight-through 80 meter operation is desired from an 80 meter crystal. The 53 drives the 802 first buffer most satisfactorily; likewise, the 802 delivers sufficient output to drive the 242-A stage. Another advantage is that the 802 stage does not require neutralizing. The 100mmf. variable coupling condenser between the 53 and the 802 is essential; it is also used to control the excitation. If an 802 is driven too hard, this type of tube will quickly flatten-out. With an 80 meter crystal in the oscillator, quadrupling to 20 meters in the second section of the 53, the output is more than ample to drive the 802 to full efficiency.

The second buffer stage uses a Western Electric 242-A, with 750 volts on the plate. This stage drives the final amplifier with 50 grid mills on 20 meters.

One of the new Ohmite Band-Changing Switches is used to short-out the unused turns on the final amplifier plate coil. The antenna tuning arrangement shown in the circuit diagram has given excellent results on all bands used. A Marconi antenna, 120 feet long, has proved very successful.

The somewhat unusual jack and switch circuit in the grid lead of the final amplifier is used to meter the grid current of each preceding stage at any time. The switch is thrown to the "ON" position, maintaining the circuit from the bias supply to the final amplifier grid, while one end of a patch cord is plugged into the jack and the other end into the desired grid circuit, either J-1 or J-2.

The front panel arrangement is symmetrical. A dial is used on the band-switch shaft in order to balance the arrangement of controls on the uppermost panel.

The transmitter is equipped with an oscilloscope; it has proved its worth in many ways. When the transmitter was first neutralized in the conventional manner, the oscilloscope brought out the fact that complete neutralization was not had at all.

The entire speech amplifier is wired with shielded wire and no trouble from r-f feedback has been experienced. The hum level is almost negligible, even with the gain control wide open. Before the speech amplifier was installed in the relay rack it was given a test on the work-bench. Considerable hum was eliminated by using two shields around the 57 tube; one Goat Mfg. Co. "form-fitting" shield was used on the tube, with another standard type tube shield placed over the Goat shield. All transformers and chokes are raised $\frac{1}{4}$ " above the chassis as a further aid in

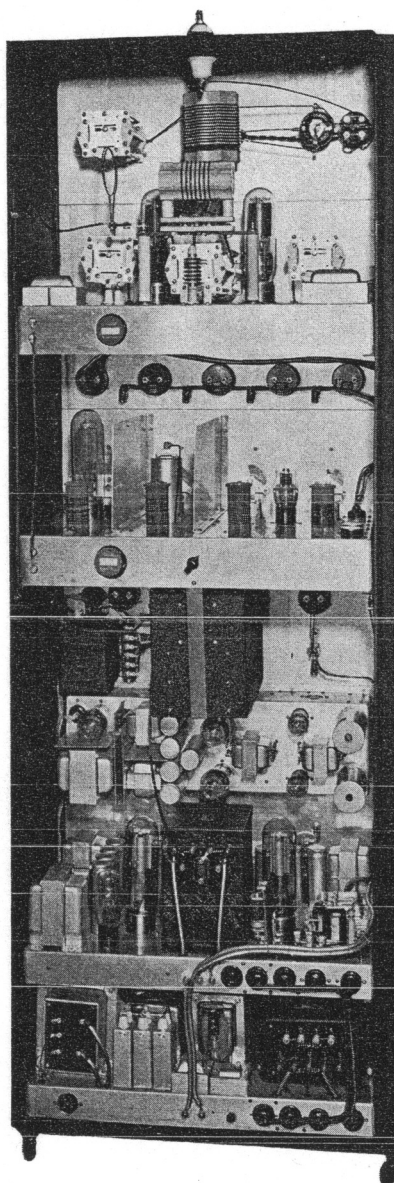

Rear View of Dr. Coate's Transmitter

reducing hum. One of the annoying sources of hum, which is extremely difficult to eliminate, is the induced hum from the power transformer to the chokes. Practically all of this hum can be eliminated by the following procedure: (1) Mount the power transformer somewhere near the end of the chassis, in any position. (2) Connect the primary of the transformer to the 110 volt a-c line, leaving everything else disconnected. (3) Connect a pair of headphones across the input choke and move the choke close to the transformer. (4) By twisting and turning the choke, a position will be found where practically no hum is heard in the headphones. Mount the

choke in that position. Repeat the process with the second choke. It is surprising how much hum can be eliminated in this manner. The same procedure holds true for the placement of audio transformers. Connect the 110 volt a-c line to one winding of the transformer, the headphones to the other, and move the transformer until the "quiet location" is found.

The filter condensers for the high voltage supply are of the oil impregnated 2000-working-voltage type. The smaller condensers are of the standard paper type. No electrolytic condensers are used anywhere in the entire transmitter.

Some interesting points were noted when the transmitter was in the course of construction. When the 802 tube was connected in accordance with instructions supplied by the manufacturer, the tube did not deliver enough output to drive the 242-A buffer, but when the screen and suppressor are tied together, as shown in the circuit diagram, the stage can still be neutralized and more than enough excitation is available to drive the 242-A, even on 20 meters. It was also found that it was impossible to secure 100% modulation without distortion, as shown by the oscilloscope, unless the 3,000 ohm resistor (R5 in the circuit diagram) is used as shown. With this added bias resistor the modulation of the final amplifier is far easier and smoother, and the oscilloscope shows no distortion even when modulating at full 100%.

The receiver used by Dr. Coate is an RME-9D, shown in the illustration on the front cover of this issue.

COIL WINDING DATA

$1\frac{1}{2}$ " forms used for all coils except those in the final amplifier circuit.

All coupling links have 2 turns, wound in the center of each coil.

20 Meter Coils (80 Meter Crystal)—

L1—28 turns No. 18 Enameled.
L2—8 turns No. 18 Enameled.
L3—10 turns No. 18 Enameled.
L4—10 turns No. 18 Enameled.
L5—10 turns No. 18 Enameled.
L6—10 turns No. 18 Enameled.

All of above coils space wound, one diameter of wire spacing between turns.
L7—6 turns No. 10 Enameled, on small size G.R. Form.

40 Meter Coils (80 Meter Crystal)—

L1—28 turns No. 22 Enameled.
L2—16 turns No. 22 Enameled.
L3—18 turns No. 22 Enameled.
L4—18 turns No. 22 Enameled.
L5—18 turns No. 22 Enameled.
L6—18 turns No. 22 Enameled.
L7—16 turns No. 12 Enameled, on small size G.R. Form.

All of above coils space wound, one diameter of wire spacing between turns.

80 Meter Coils (80 Meter Crystal)—

L1—28 turns No. 22 Enameled.
L2—No. Coil Used.
L3—40 turns No. 22 Enameled.
L4—40 turns No. 22 Enameled.
L5—40 turns No. 22 Enameled.
L6—40 turns No. 22 Enameled.
L7—20 turns No. 12 Enameled on Large Size G.R. Form.
L8—15 turns No. 10 Enameled on Large Size G.R. Form, tapped at 7 and 3 turns.
Coils L1 to L6 are close wound.

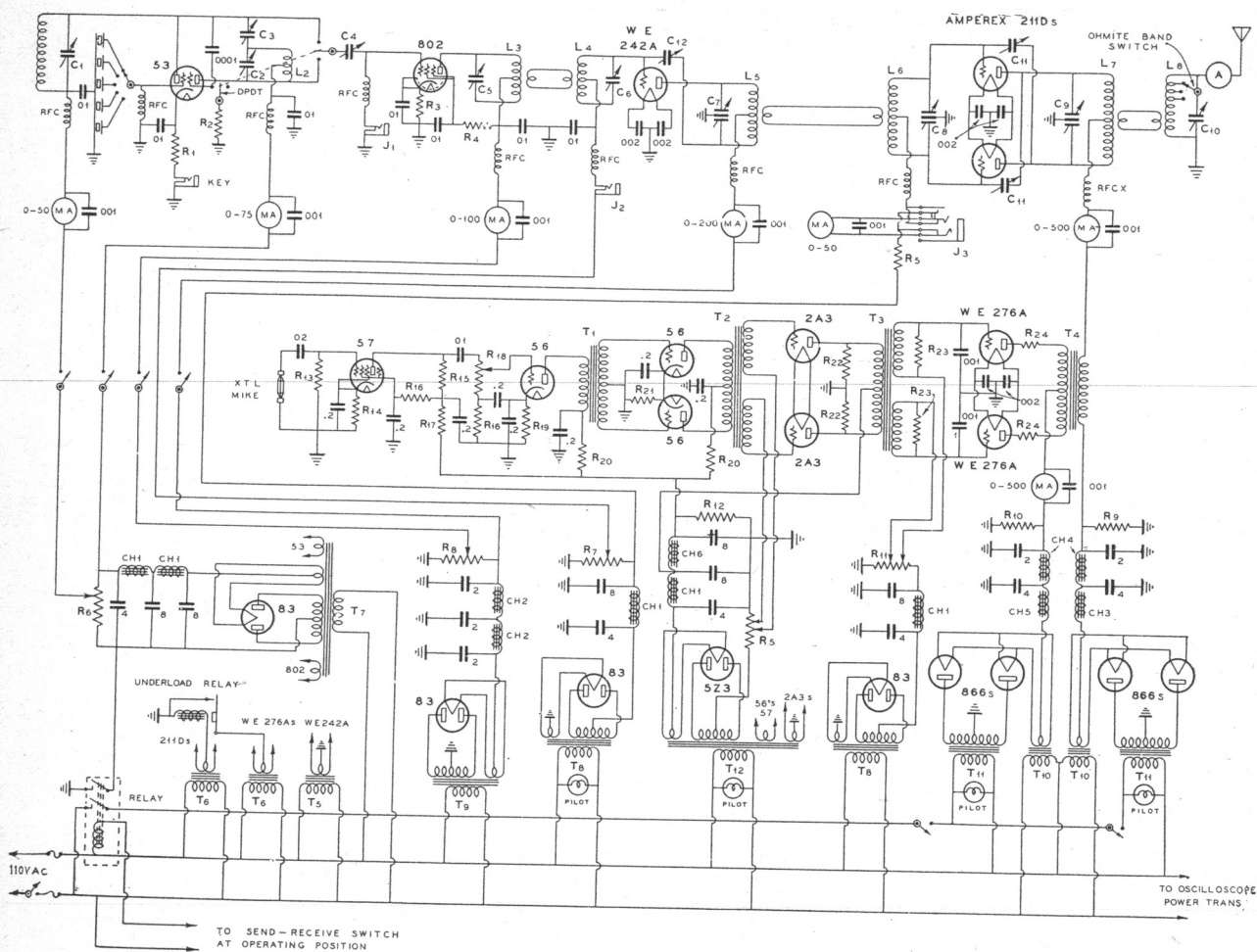

LEGEND FOR CIRCUIT DIAGRAM

- C1—National TMS-100.
- C2—National TMS-100.
- C3—35mmfd Mica Padding Condenser.
- C4—Hammarlund MC-100M.
- C5—National TMSA-50.
- C6—National TMSA-50.
- C7—National TMC-100D.
- C8—Hammarlund MC50SX, Ganged.
- C9—National TMP-100A.
- C10—National TMP-100A.
- C11—National TMS.
- C12—National TMSA-35.
- R1—400 ohms, 10 watt.
- R2—50,000 ohms, 10 watt.
- R3—2,000 ohms, 10 watt.

- R4—20,000 ohms, 10 watt.
- R5—3,000 ohms, 50 watt.
- R6—50,000 ohms, 50 watt.
- R7—2,000 ohms, 200 watt.
- R8—50,000 ohms, 100 watt.
- R9—50,000 ohms, 200 watt.
- R10—50,000 ohms, 200 watt.
- R11—1,500 ohms, 200 watt.
- R12—50,000 ohms, 50 watt.
- R13—5 megohms.
- R14—3,000 ohms, 1 watt.
- R15—200,000 ohms, 1 watt.
- R16—100,000 ohms, 1 watt.
- R17—50,000 ohms, 1 watt.
- R18—500,000 ohms, Vol. Control.
- R19—2,500 ohms, 2 watt.

- R20—5,000 ohms, 2 watt.
- R21—1,000 ohms, 2 watt.
- R22—500,000 ohms, 1 watt.
- R23—10,000 ohms, 2 watt.
- R24—40 ohms, 2 watt.
- RFC—125 MA RF Choke.
- RFCX—500 MA RF Choke.
- T1—Inca G-16
- T2—Inca G-17
- T3—Inca L-28
- T4—Inca N-14
- T5—Inca J-15
- T6—Inca L-5
- T7—Inca C-66
- T8—Inca B-41
- T9—Inca B-15
- T10—Inca J-3
- T11—Inca B-35
- T-12—Inca L-21
- CH1—Inca D-3
- CH2—Inca D-5
- CH3—Inca D-11
- CH4—Inca D-6
- CH5—Inca D-42
- CH6—Inca D-23

FLASH!

● Effective with the January issue of "RADIO", this magazine and "R/9" will be combined. Publication will hereafter be from Los Angeles, California. The entire technical staffs of both magazines have been consolidated. The new publishing corporation, RADIO, Ltd., 7460 Beverly Boulevard, Los Angeles, California, will be the home office of the combined magazines. All subscriptions, advertising contracts and correspondence relating to the magazines "RADIO" or "R/9" should be sent to the Los Angeles offices.

"The 'RADIO' Handbook", and other books by "RADIO", will continue to be separately published and distributed by Pacific Radio Publishing Co., Pacific Build-

ing, San Francisco, California. Orders for these books should be sent to the San Francisco address.

The greater "RADIO" will be a revelation. Its technical staff . . . Jones, Kruse, Hawkins, Smith, Gordon and others, will constitute the largest and finest means for giving you the best of everything in Amateur radio. Its business force and its new advertising staff is made up of men who have been in the radio publishing field for almost 20 years.

The next issue of "RADIO" will be the first published by the new organization. Expect great things; you will not be disappointed.

All those who subscribed for both "RADIO" and "R/9" will have their subscriptions to "RADIO" automatically extended.

U-H-F Receiver With Regenerative R-F

A simplified version of the Jones Relay Rack Receiver described in the November issue.

--- By the Technical Staff ---

● This receiver has very good sensitivity on the ultra-short wave bands below ten meters. It uses a regenerative RF stage, super-regenerative detector, interruption frequency oscillator and a pentode audio amplifier. The set is very small; it will fit into a cabinet 9-in. x 7¼-in. x 5-in. Two Acorn type tubes and two of the new metal tubes are used, although the latter can be replaced with 76 and 41 tubes of the glass envelope type.

The Acorn tubes are used in the radio-frequency portion in order to secure maximum sensitivity down to at least two meters wavelength. Tip jacks in a hard rubber panel mounting are used in order to allow easy changing of coils. The 2½ meter coil has four turns, a little over ½ inch in diameter, and the detector will still super-regenerate with only a shorting link connected across the three tip jacks.

tuning condenser on the 6C5 tube depends upon the type of interruption frequency coils used. This value, in conjunction with the detector grid leak, plate voltage and plate by-pass, can be varied to obtain most satisfactory results. The detector will super-regenerate without the 6C5 oscillator if a .005 or .006 mfd. condenser is connected from ground to the top of the audio transformer primary; i.e., the plate side. Either arrangement of the .005 or .002 is satisfactory, the circuit as shown being a little more smooth in its operation.

The 955 detector plate voltage must be

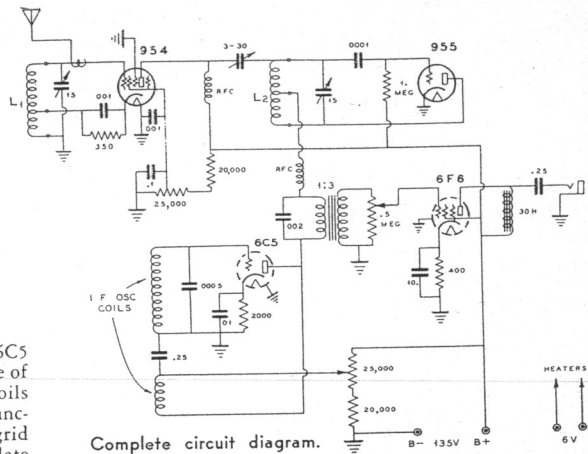

Complete circuit diagram.

FOR 5 METER OPERATION:
L1—10 turns, No. 12, tapped at 1 turn.
L2—10 turns, No. 12, center-tapped.

FOR 2½ METER OPERATION:
L1—4 turns, No. 12, tapped at 1 turn.
L2—4 turns, No. 12, center-tapped.

All coils should be about 1½ inches long.

winding 75 turns of about No. 28 DSC wire on a ¼-in. diameter rod, and pulling the coil off of this winding form when it is wound. The plate coupling condenser is a 3-to-30 mmfd. isolantite base trimmer condenser, supported by soldering one of its terminals to the coil pin jack. The grid and plate leads of the 954 RF tube are made with small wire leads so as to be somewhat flexible.

The 954 tube is mounted so that its grid protrudes through the metal shield portion into the RF stage. Double shielding may

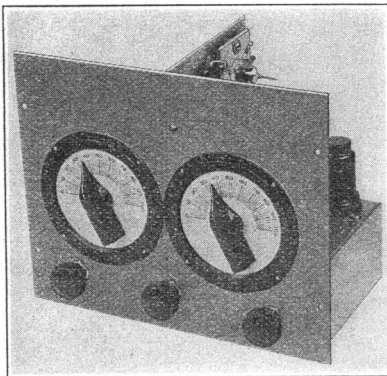

Front panel view

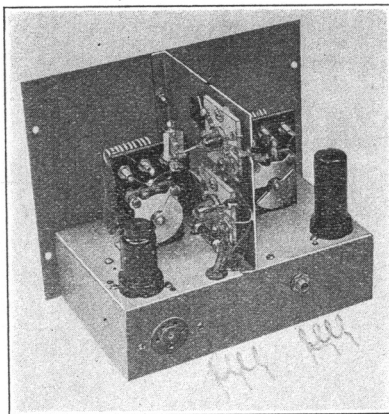

Rear view, showing Acorn tubes.

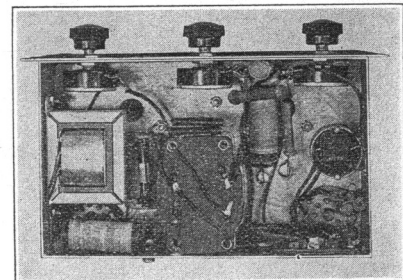

Under-chassis layout.

A 954 Acorn screen-grid tube is used as a tuned RF amplifier with cathode regeneration in order to improve the gain. Regeneration in this RF stage makes the receiver much more sensitive, when used properly. The detector uses a 955 Acorn tube as a super-regenerative device, with a 6C5 tube acting as a separate interruption frequency tube. The 6F6 tube acts as a regular pentode audio amplifier, transformer coupled to the 955 detector tube. A small 30 henry choke supplies plate current to the 6F6 tube and a ¼ mfd. by-pass condenser is used to isolate the headset or loudspeaker from the plate voltage. This is desirable for either headset or magnetic loudspeaker operation in order to prevent the flow of DC plate current through either the speaker or phones.

Self-bias provides proper grid bias for the 6F6 tube and a ½ megohm volume control across the secondary of the 3-to-1 step-up audio transformer is used to control the volume. The primary of this audio transformer is by-passed with a .002 mfd. by-pass condenser due to the fact that the 955 is "plate modulated" by the 6C5 low-frequency oscillator. Super-regeneration is obtained by this means. The value of .0005 mfd. grid

adjusted to its best value in order to gain full use of the regenerative RF stage. A 25,000 ohm potentiometer provides a continuously variable adjustment of this voltage. It should only be set high enough to obtain super-regenerative hiss when not tuned to a signal. The detector grid leak can be connected to either plus B or to ground. The latter might prolong tube life, but the former gives better audio quality on strong signals. As long as the detector oscillates the actual grid bias voltage on the detector is about the same in either case.

The RF stage has the cathode connected to the grid coil, one turn above the grounded end on both the 5 and 2½ meter coils. The best position for this tap will depend upon the physical layout of parts used, and on the length of ground leads in this RF circuit. All leads should be as short as possible. Screen-grid voltage variation provides a control of regeneration and RF gain. The suppressor grid connects directly to ground instead of to cathode, in order to more effectively screen the plate from the grid circuit. Capacity coupling is used to the detector circuit and a small RF choke is used to provide DC plate voltage. The RF chokes are made by

sometimes be helpful, but due to the small size of the coils, the electromagnetic field is small. The RF by-pass condensers are of the .001 mfd. midget type, connected to the ground shield or coil by short leads. The heater is also grounded on one side at the socket, since the cathode of this stage is at some RF potential. A larger .1 mfd. condenser is connected across the regeneration control in order to prevent possibility of noise from this source. This control circuit and the detector plate voltage control circuit act as bleeders across the 135 volt plate battery; therefore, a B battery switch as well as filament supply switch should be used when turning off the receiver. If higher plate voltage is used, the values of the resistors must be changed.

The hard rubber panels which support the tuning condensers and coils are 2-in. x 3¼-in., with the tip jacks mounted along the top edges above the tuning condensers. The leads to the tubes, and especially to the tuning condensers, must all be very short. Flexible insulated shaft couplings are used on both tuning condensers, and a dial is used for tuning each condenser separately, due to

(Continued on page 14)

A Portable Relay Rack Transmitter and Receiver

Modern Design... Jones Exciter... Jones Improved Super-Gainer Using 53 Tube

● The transmitter uses a 53 push-pull crystal or TNT oscillator driving a 2A3 neutralized RF amplifier. The oscillator has been previously described; it has an output of as high as 10 watts at 375 volts plate supply. Cathode bias, plus push-pull connection of series tube capacities, prevents undue stress on the crystals, resulting in low values of crystal RF current, heating, and frequency drift.

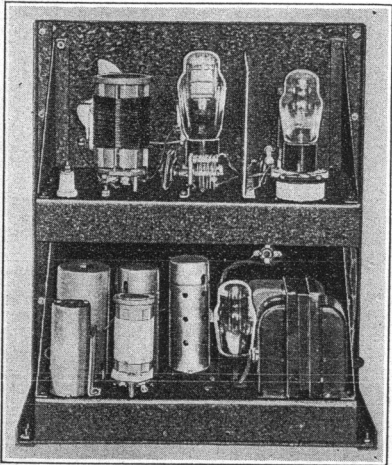

Rear view, with transmitter on upper deck; receiver and power supply below. All tubes in the receiver are shielded.

The 53 oscillator plate coil is split so that it can be used as a neutralizing system for the 2A3 by connecting the neutralizing condenser from 2A3 plate back to the coil end opposite the grid connection. The 2A3 neutralizes satisfactorily, and any antenna coupling system can be used, such as the simplified pi network shown. The antenna can be coupled inductively to the 2A3 plate coil if desired. This coil, L_5 is rather critical for proper number of turns, depending upon the ratio of the two tuning condenser capacities and antenna impedance. A satisfactory arrangement is to take taps about every 4 or 5 turns on the coil L_5 and short-circuit the unused turns with a short lead. The coil can be of the plug-in type because the shorting wire would be between coil taps.

The same power supply is used for both transmitter and receiver. A large 20 or 30 henry filter choke is used for choke input to the filter and a 16 mfd., 600 volt peak electrolytic condenser completes the filtering action for the transmitter. Choke input is needed in order to keep the plate voltage within reasonable limits when keying the common center-tap and cathode leads to the two tubes. The receiver has additional filter in the form of a 10,000 ohm 10 watt resistor, and an 8 mfd. filter condenser. This value of resistance is just as effective as the use of another good filter choke coil. The receiver plate voltage should be between 125 and 160 volts for operation with the circuit constants shown.

The receiver is the "Super-Gainer" three tube superheterodyne receiver previously described in these pages.

2½-volt tubes are used, and a 53 replaces the 79 used in the models previously described. The same resistor values can be used for either tube, but if a lower audio

By C. C. ANDERSON, W6FFP

amplifier grid leak is used as shown, no hum trouble is experienced. The heater center-tap should be grounded. The 53 requires a large size tube shield because it has a larger glass envelope than a 79, and, of course, a 7 prong instead of a 6 prong socket is also required.

The receiver circuit consists of a 57 regenerative first detector with screen-grid voltage control. A cathode tap on the detector RF coil provides regeneration up to the point of oscillation. A separate 56 high frequency oscillator is used in order to eliminate interaction common to 2A7 tubes. Suppressor grid injection is used to feed oscillator power into the first detector. An ordinary tickler coil is used to secure oscillation in the 56 tube at a frequency 456 KC higher than that to which the detector is tuned.

An iron-core Aladdin IF transformer with adjustable coupling is used to provide selectivity. The 53 tube acts as a regenerative second detector and audio amplifier. This regeneration gives very good selectivity and sensitivity, comparable to larger superheterodyne receivers. For receiving CW this second detector regeneration is turned up until oscillation is obtained and the usual beat note heard. Regeneration is obtained by means of a 100 turn coil, 1¼" diam., of No. 30 Enam. wire, connected in series with the cathode of the 53. To control regeneration, a 10,000 ohm tapered variable resistor is shunted across this cathode coil.

Resistance coupling connects the detector to the audio amplifier section of the 53 tube. A low value of grid resistor is used to prevent AC hum amplification and to limit the audio gain to a value sufficient for headset reception. A short circuiting switch across

the headset allows the receiver to be kept quiet when transmitting.

100 mfd. trimmer or band setting condensers are used to tune to the desired band in any given coil range. The coil turns shown in the table were chosen so that each amateur band covers a good portion of the main tuning bandspread dial. A rebuilt two-section double-spaced split-stator 35-35 mmfd. condenser is used for the main tuning control. Two oscillator section plates were re-

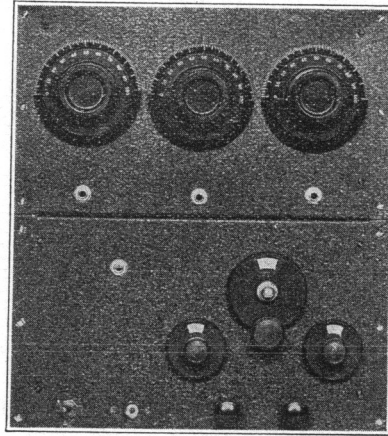

Front of panel view, showing receiver and transmitter controls.

moved, also one plate from the detector section stator. This is done so as to remove two dielectric spaces from the detector section and three from the oscillator section. A small grounded metal shield should be placed

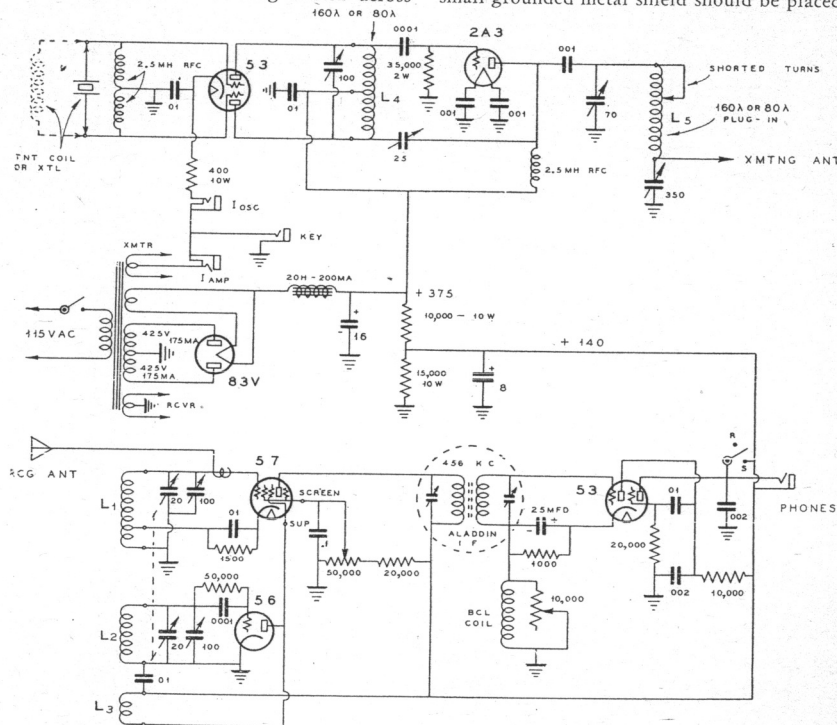

Circuit diagram of the complete transmitter and receiver. TNT coil can be used in the oscillator in place of the crystal, as shown.

between the two condenser sections if 20 meter tuning inter-action is to be minimized.

A separate antenna should generally be used for receiving, unless an antenna switch is provided. Coupling to the regenerative first detector should be rather loose in order to allow regeneration. Capacity coupling is used in the form of a few turns of insulated wire twisted around the grid lead.

A one-microvolt signal is clearly audible in the headset output of the receiver when the circuits are tuned properly and when the full effect of duplex regeneration is utilized.

Transmitter Output

The transmitter will put out from 25 to 30 watts of RF when the plate supply is about 400 volts at 100 MA of plate current to the 2A3. The 53 oscillator uses from 50 to 75 MA of cathode current and drives the 2A3 hard enough for good Class C operation.

Antenna tuning with the circuit shown is accomplished as follows: (1) The antenna 350 mmfd. condenser is used with capacities between 350 and 150 generally toward the high capacity setting. (2) The plate tuning condenser is adjusted for resonance, completing the plate tank circuit through the

350 mmfd. condenser and coil L_s. In order for an antenna of some given length to pull a good load out of the 2A3 amplifier, the ratio of these two tuning capacities must be correct. With some antennas, the turns in L_s must be changed in order to accomplish this effect. The principal advantage of this antenna matching circuit is that nearly any length of antenna can be used, and it greatly reduces radiation of harmonics. This system works best with a single wire feeder to a Hertz half or full wave antenna.

TRANSMITTER COIL DATA

Wavelength	L ₁ Osc. Coil	L _s Amp. Coil
160 Meters	70t of #22DSC. Close wound and C.T. 1½" diam.	55t of #19DSC. Close wound and tapped at 50, 45 and 40 turns. 2¼" diam.
80 Meters	34t of #18DSC. C.T. 1½" diam. 2" long.	33t #16 Enam. 2" long. 2½" diam. Tapped at 29th and 25th turn.

RECEIVER COIL DATA

All in 1½" Diameter Forms

Wavelength	L ₁	L ₂	L _s
160 Meters	1¾" winding of #24E. Tapped at 1½ turns. Close wound.	1¼" winding of #24E. Close wound. Grid on top end.	12t #24E. Close wound ½" from L ₁ . Same direction as L ₂ with plate on far end.
80 Meters	40t #20 DSC, spaced to cover 1¾". Tap at ¾ turn.	33t #20DSC, spaced to cover 1¾".	8t #24E. Close wound ⅞ inch from L ₂ .
40 Meters	12t #20DSC, spaced to cover 1½". Tap at ½ turn.	11t #20DSC, spaced to cover 1¼".	5t #24E. spaced ¼" from L ₂ .
20 Meters	5t #20DSC, spaced to cover ⅞". Tap at ½ turn.	5t #20DSC, spaced to cover ⅞".	2½t #20DSC, spaced ¼" from L ₂ .
10 Meters	3½t #20DSC, spaced to cover 1 inch. Tap at ⅓ turn.	3½t #20DSC, spaced to cover 1".	2½t #20 DSC ¾" from L ₂ , and ⅞" between turns.

U-H-F Receiver With Regenerative RF

(Continued from page 12)

the use of regeneration. If patience is used in making the coils of proper length, and if all other adjustments are carefully made, the two tuning condensers can be ganged together for single-dial control. The RF stage would then require a small semi-adjustable trimmer across the grid circuit in order to compensate for the shunt capacities in the detector circuit.

Several methods of antenna coupling were tried. A small four-turn coupling coil near the grounded end of the RF coil proved best when using a two-wire matched impedance feeder antenna system. Capacity coupling, as shown, works well when using any other form of antenna. Connecting the antenna to the cathode tap also gives good results. This coupling must be adjusted so as to allow regeneration to be obtained.

In tuning this receiver, the super-regeneration control is turned-up only far enough to obtain a hiss, indicating super-regeneration. The RF stage is then tuned across the dial range with the regeneration control fairly-well advanced. If this stage is oscillating, the receiver will go "dead", i.e., the hiss will disappear over a part of the RF tuning range when the detector is left at some fixed dial reading. Backing down on the regeneration control, and possibly increasing the antenna coupling at the same time, will eliminate this dead spot, and at this adjustment the usual auto ignition noise can be heard if automobiles are running in the near vicinity. The actual tuning of the RF stage is fairly sharp with regeneration. The two dials can be tracked by listening to the incoming electrical noise due to the high sensitivity of the receiver.

A little juggling of the controls soon enables one to obtain proper results. After a little practice the tuning is not at all complicated. This receiver is not as simple to tune as a transceiver, but its sensitivity is much greater on weak signals.

The 15 mmfd. tuning condensers cover quite a wide range and a little better band-spread can be obtained by removing one plate, leaving only two plates in the tuning condenser. The set should normally be mounted in a metal cabinet in order to complete the RF stage shielding. More gain can be secured when the receiver is completely shielded.

Stable U. H. F. Oscillators

(Continued from page 9)

three or four inch arc could be drawn with a lead pencil, and it would remain shooting into the air after pulling the pencil beyond the arcing distance. The arc apparently ionized the air, and it would shoot out for awhile like a corona discharge. With antenna load, the RF voltage available for arcing was, of course, much smaller.

The final amplifier used a power supply having a 3000 volt, each side of center, power transformer. Choke input was used and any voltage of from about 1100 to 2700 volts was available by cutting in one or more paralleled electric heater 600 watt resistors in series with the 115 volt line circuit. A pair of 872A rectifier tubes was used, although at the plate current used a pair of 866 rectifiers would have been suitable. The plate current to this amplifier was usually about 200 to 220 MA with antenna load.

Operating this amplifier at 2000 volts and around 200 MA, about 200 watts of audio power would be required for high-percentage modulation. An 838 Class B modulator will supply this amount of audio power with some to spare when operated from a 1250 volt power supply. The latter was used as a power supply for the 50T oscillator since an additional filter section isolates it from the 838 Class B modulator supply point. This point was by-passed with 6 mfd. of capacity using a swinging choke input. The 838 tubes have an initial high value of plate current and therefore the current change with Class B modulation was not considered important as to effects on the RF frequency of the stabilized oscillator in the M.O.P.A. The 838s are driven by a pair of 45s in Class A prime with a 57 pentode and 56 triode speech amplifier for crystal microphone input.

This M.O.P.A. under these conditions will furnish a quarter KW carrier capable of 90 to 100 per cent modulation without excessive frequency modulation. A rough check seemed to indicate not over 10 or 15 KC frequency change. In any of these 5 meter oscillator circuits there is an initial creepage due to tube and circuit changes which occur while reaching operating temperature. This can be detected by listening to the harmonic beat note with a frequency-monitor meter

such as used on 20 or 40 meter CW transmitters.

The efficiency, as near as could be roughly checked, was nearly 20 per cent higher for the M.O.P.A. neutralized amplifier as compared with the push-pull oscillator outputs for the same inputs. The approximate efficiencies ran about 60 per cent and 40 per cent respectively, roughly determined by means of Mazda lamps (without sockets) used as a dummy antenna.

Got Trouble?

● Send your questions; they will be answered in Ham Hints. If you have a problem that has been worrying you and a number of your fellow amateurs, send it to the Technical Editor of "RADIO" and we will solve it for you in these columns. And, remember . . . those who send good Ham Hints for publication will be given a subscription to "RADIO" for one year without cost.



Next Month's

Issue of

"RADIO"

Will Have

100 PAGES

Start the New Year Right
by Subscribing Now

New Rates - \$2.50 Per Year

10-Meter Phone-CW Transmitter

30-Watt Phone Carrier . . . 100 Watts CW

By FRANCIS CHURCHILL

Here is a breadboard transmitter which has a carrier output of 30 watts on phone and nearly 100 watts on CW in the 10 meter band. The complete set, less power supplies, is built on a 11-in. x 30-in. x 3/4-in. oak baseboard, mounted on end cleats. The space under the baseboard provides room for wiring and small condensers, resistors, current measuring jacks and switches.

The variable condensers as shown have sufficient capacity for operation in the 80, 40, 20 or 10 meter bands by changing coils and crystals. Crystal control is used because it provides better frequency control than any other system.

A 6A6 twin triode tube is used for the crystal oscillator and doubler on 40 and 20 meters with the coils shown. Regeneration in the doubler section increases the available output; control of excitation to the grid of the RK25 pentode is had by a 50 mmfd. variable midjet condenser. Regeneration allows the operation of the 6A6 as a quadrupler to 10 meters from a 40 meter crystal, but somewhat less tube heating is experienced when the RK25 is used as a doubler to obtain 10 meter RF output.

No difference in modulation quality can be noticed by monitor tests when operating the RK25 either as a straight buffer or as a doubler stage. Suppressor modulation is simple and easily adjusted when these small pentode tubes are used. For CW operation, a switch changes the suppressor grid from the negative 45 volt bias to a positive bias of about plus 45 volts. This increases the RF output, with the result that more grid drive can be given to the final stage.

The final amplifier uses a pair of RK18 tubes in push-pull. These tubes are of the

modulated RF wave up to about a 25 or 30 watt carrier. For CW operation, a 5000 ohm grid leak is cut into the grid return lead for additional bias at approximately cut-off. The Mazda "ballast" lamp is unscrewed from its socket and the RK25 RF output increased several times by switching-over the suppressor

no grid RF choke should be used, especially in high power linear stages.

The modulator consists of a 6C6 pentode audio amplifier having a gain of about 100. Since a crystal microphone is used, the entire input circuit including plug and jack must be shielded. The 6C6 tube drives a 41 modulator tube having a one-to-one ratio output transformer. This provides only enough audio gain for close talking into a

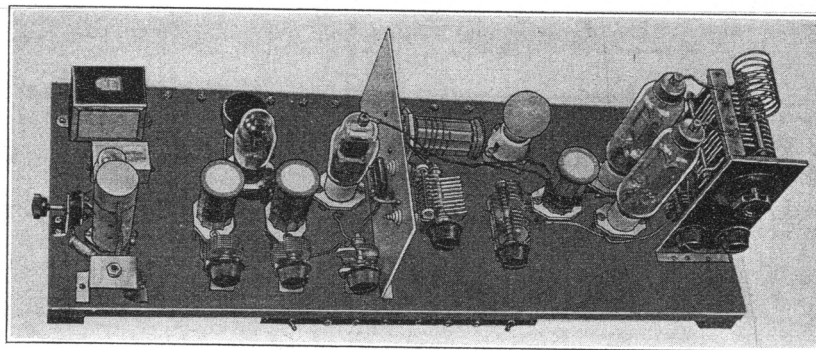

Speech and RF channel, breadboard mounted. The arrangement of parts should be as shown.

grid. These three operations allow Class C operation in the final amplifier with an output of from 90 to 100 watts at much higher plate efficiency. For phone operation it is necessary to operate it at cut-off grid bias in order to get linear RF amplification, which takes place at rather low plate efficiency.

A one-turn coupling link proved satisfactory between stages, and the grid load Mazda lamp was also link coupled to the grid coil.

diaphragm type crystal microphone. The same audio channel could be used to grid-bias-modulate the final amplifier, if desired. The final stage would require a 500 ohm 40 watt resistor in the filament center-tap lead as a self bias resistor, in addition to the —45 volt "C" battery for grid-bias modulation.

On phone operation the approximate carrier output is 30 watts with a 1000 volt plate supply on the final and a 385 volt supply on the crystal oscillator and RK 25 stages. The grid current on the final is run at one MA, and the plate current at from 100 to 110 MA. The antenna load must be tightly coupled to the linear stage in order to obtain linear amplification and upward swing on antenna current with modulation. The 6A6 cathode current runs about 60 MA, the RK 25 plate 25 MA; screen at 20 MA.

On CW operation the crystal oscillator runs the same: the RK 25 plate current, 50 MA; grid current on the final, 10 to 15 MA through 5000 ohm leak and —45 C battery; the plate current, 175 MA on the final. The antenna coupling need not be as great for CW operation. In both cases the RK 25 is operated as a doubler. An 802 pentode could be used if 500 to 600 volt plate supply is available. Other final amplifier tube combinations would be 930-Bs, 50Ts, or 800s. The 800s might require more RF drive than is available, for reasonable efficiency. Low C tubes, those having low inter-electrode capacities, are best for operation on 10 meters. A pair of 801s in the final would give about 15 to 20 watts carrier on phone, and 50 to 65 watts on CW, when operated at 750 volts plate supply. The 50T tubes would give more output than the RK18, due to greater plate dissipation ratings, but they would require a higher plate voltage.

The power supplies could be a 400 volt unit capable of supplying 150 MA and a 1000 or 1100 volt unit supplying 175 MA. The latter could use three 83 rectifier tubes in a bridge circuit. In testing this transmitter, miscellaneous power supplies in the laboratory were used.

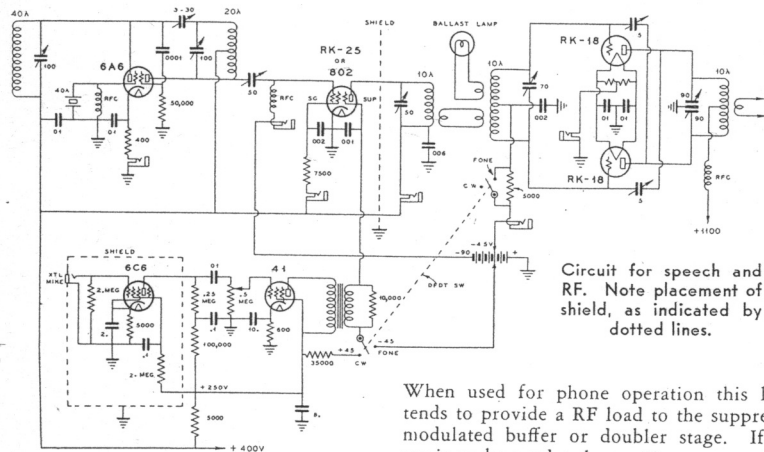

Circuit for speech and RF. Note placement of shield, as indicated by dotted lines.

40 watt plate dissipation rating and are suitable for use on very high frequencies. The inter-electrode capacity is lower than in a type 10 or 801, and since the mutual conductance is about twice as high, the RK18 is more easily excited, an important feature on 10 or 20 meters. The plate leads come out the top of these tubes. The split-stator plate tank condenser is mounted high on a sub-panel so as to enable the use of very short leads. Short, symmetrical leads are very important in obtaining good efficiency and neutralization on 10 meters.

For phone, this final amplifier is operated as a Class B linear stage amplifying the

When used for phone operation this lamp tends to provide a RF load to the suppressor modulated buffer or doubler stage. If the set is to be used only on 10, or even on 10 and 20 meters, the 70 mmfd. grid tuning condenser can be connected in a split-stator connection of 35 mmfd. per section for a more balanced input circuit. More grid inductance would be needed, due to the lower tuning capacity. However, a split-stator condenser in the grid circuit of a linear stage can cause trouble unless all leads are of equal length and the grid coil is exactly center-tapped. A grid RF choke should not be used because it nearly always causes a low-frequency parasitic oscillation. A plate RF choke is needed in order to obtain neutralization when plate voltage is applied; thus

A Phone-CW Transmitter That Grows From 5 to 500 Watts

By ROBERT M. JONES, W9PSZ

Careful analysis reveals that the average amateur transmitter closely resembles a book of paradoxes in not one but several ways. To begin with, most of us have at least the hope of eventually pumping the maximum allowable kilowatt of power into the final plate circuit, yet few and very far between are the rationally planned designs which permit us to start with a small rig and progressively, simply and economically build it up into our final dream. Usually in its final form it appears more like a Goldberg cartoon than a ship-shape rig.

To go on a bit further, most of us try to economize on tube cost, so that we eventually spend more in gadgets to avoid straightforward initial tube cost, and not only end up with a scattered, wind-blown rig, but one tricky and difficult of adjustment, and of a design so antiquated as to be reminiscent of Noah's Ark—in brief, something in 1935 that would have been hot stuff ten years ago.

At which the irritated reader boasting a pair of 852s, which were never even designed for the service most of them get in amateur transmitters, will probably rise in his wrath and exclaim "so what?—it gets out, doesn't it?" The answer is, of course, "yes, it gets out," but is its owner such a negation of the whole spirit of advancement and progress that characterizes amateur radio that he is not even interested in finding out how to get out better, cheaper and quicker?

Much water indeed has gone under the engineering dam since 20As and 852s were the acme of known perfection, and while they still work as well as ever, newer means of doing better jobs are now at hand. Briefly, and to skip the planning and replanning, the building and rebuilding involved, a design is here presented that may start at as little as five watts, and grow in sensible and economical steps to 25, 50, 200, 300 and finally to 500 watts RF output, and to almost the 1 KW legal input. This is for those of us who do not "work for the government" and must watch shekels. For those of us who can lay out two hundred and fifty dollars at one crack, it is the complete answer to the modern, not antiquated, multi-band phone-CW transmitter offering the maximum of convenience, flexibility and efficiency for the minimum of cost. So much for those readers who may be thinking that we can criticize destructively, as can anybody, but cannot build constructively.

The actual progressive transmitter consists of four units, the exciter, its power supply and modulator, the final 200 to 500 watt RF amplifier, and its 1/2 to 1 KW power supply. All four units are assembled on standard pierced panels and chassis available from any jobber, and built progressively, give the clean and direct answer to the old question of the best way to get more RF watts out for additional dollars put into the rig. From an economy standpoint, 50 watts of CW or 15 watts of phone carrier can be put on the air for less than \$70.00 for everything but mike, and as the additional units are built and added, not one plugged nickel of previous investment need be discarded. Yet at each progressive step of development, the ship-shape appearance, flexibility and efficiency is maintained, and the additional cost of getting more power into the antenna is in such gradual and easily taken steps that the builder is not discouraged about increasing power after the first units are put on the air.

The circuit diagrams and photos tell the

story of what we believe is a really commercial outfit any amateur at all can be proud to own.

The exciter uses the Jones harmonic oscillator with its power supply-modulator and the crystal speech microphone. In Fig. 1, the dials left to right are, crystal oscillator, buffer plate, amplifier plate, and antenna tuning. The upper left knob is buffer

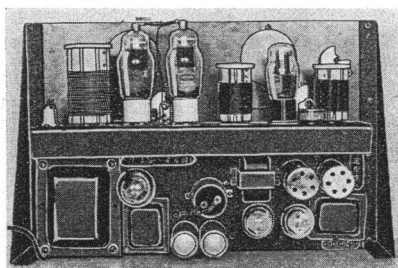

FIG. 2. Rear, showing the upper RF—deck with 6A6 oscillator—buffer at right, and two RK-25, 25 watt RF pentodes at left. Below is the power supply-modulator, with 83V at left, two 42s and 76 and 6C6 (right shielded).

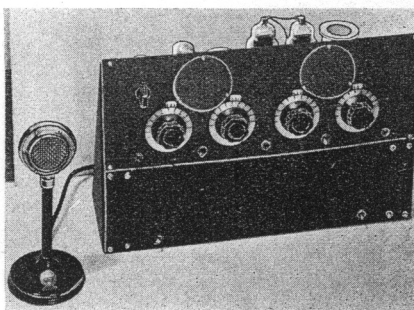

FIG. 1. The complete 50 watt CW 15 watt phone transmitter or exciter, with its power supply, modulator, mike, and antenna tuner, too.

neutralization or regeneration. The row of jacks and switches below the dials are, left to right, oscillator-buffer plate current and keying, send-receive switch, amplifier grid current, phone CW switch, and amplifier plate current. All this is on a panel 7-in. x 19-in., and a chassis 6 1/2-in. deep—a complete 5 to 50 watt RF exciter or transmitter.

Note particularly the blank meter discs—each steel panel is pierced with two mount-

ing holes for 3-in. meters, with two blank discs to cover these holes if meters cannot be afforded, and with two additional discs to accept 2-in. meters—indeed a novel and welcome idea.

On the 5 1/4-in. x 19-in. panel below the exciter is the 500 volt power supply and the three stage suppressor modulator, with modulator on-off switch at left and master on-off switch at right.

Admittedly the rig is pretty from the front, but how is it from the rear? Fig. 2 tells an equally clean story, showing right to left on the top deck the crystal oscillator-buffer tube, buffer plate coil, two (or one)

both, but with ordinary small tip-jack insulating washers below them, as they are B+ off the grounded chassis. Likewise, the circuit grounds are to a common bus, not to the chassis, to which they are grounded only through the send-receive switch. And for those who may not thrill to bakelite sockets, the ones shown are easy to mount, and within 1.6% as good as Isolantite at 20 meters—

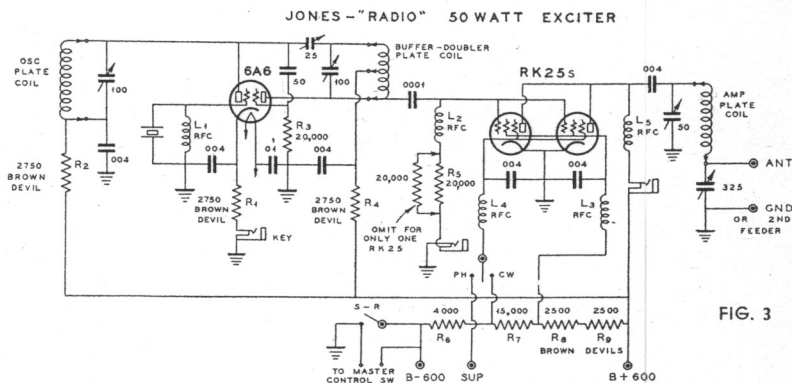

ing holes for 3-in. meters, with two blank discs to cover these holes if meters cannot be afforded, and with two additional discs to accept 2-in. meters—indeed a novel and welcome idea.

On the 5 1/4-in. x 19-in. panel below the exciter is the 500 volt power supply and the three stage suppressor modulator, with modulator on-off switch at left and master on-off switch at right.

Admittedly the rig is pretty from the front, but how is it from the rear? Fig. 2 tells an equally clean story, showing right to left on the top deck the crystal oscillator-buffer tube, buffer plate coil, two (or one)

just as good at 40 meters and above. And remember, there are lots easier ways to loose 1.6% than in sockets—but similar Isolantite ones are available if you like them better.

The power and modulator unit uses an 83V rectifier with a good husky power transformer, filter choke, oil input condenser, and two 16 mfd. wet condensers in series at filter output.

The modulator uses one 6C6 to drive one 76, which pushes one 42 to suppressor modulate one or two RK-25s. For one or two RK-28s in the final, two 42s are paralleled as shown (push-pulling audio pentodes gives no gain, only more cost). In this case, the air-gap in the Chitran No. 2769 modulation

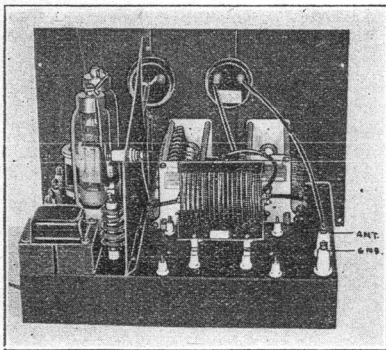
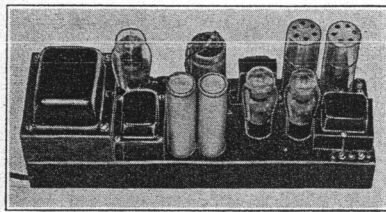

FIG. 4—Rear of the "final" showing how the 10, 20, 40 meter plate inductor drops down on four more small standoff insulators.

transformer is doubled by putting in a second spacer between E and I core legs as thick as, and in addition to, the one found there. The circuit diagram and Figs. 4 and 5 tell the mechanical and assembly story.

Fig. 5 shows the "papa" rig all assembled in a 35-in. relay rack that costs little and does an A-1 job. The center panels are the RF exciter and power-modulator unit, the bottom the 1 KW power unit, and the final RF amplifier, with Jones-Collins antenna tuner, at the top—nothing else to buy or build.

The switches on the power unit are left, filament or master on-off switch, and right,



The 500 volt power supply and 3 or 6 watt, three-stage modulator chassis.

the d.p.d.t. toggle switch, one side of which closes the plate power transformer circuit, with the other available to parallel the S-R switch of the exciter unit—so one flip of this switch puts the whole rig on or off the air.

This power supply is a real contribution to dollar saving. It uses two of husky yet low priced 2300 volt, 450 MA power transformers (ignoring their center-taps), one on each side of the full wave rectifier circuit. Thus at an economical start, one transformer with one 866A rectifier may be used single wave to get 1700 volts at 450 MA (with 4 to 6 mfd. of filter input capacity, if this much current can be drawn) to make one RK-28 turn out 200 RF watts, and then the second transformer and 866A can be added to get 500 or more watts out of two RK-28s, or between 250 and 300 watts from one RK-28. Half wave rectification is recommended only where plenty of extra filter capacity is available, for 3 mfd., while OK for full wave, is no good for half wave.

The rear of the whole assembly shows the interconnecting leads between units and particularly the hook-up wire link between RK-25 plate coil (only one RK-25 is needed to drive two RK-28s plenty hard). This link is 1½ turns of No. 10 to No. 14 enameled wire held on standoffs around the final's grid coil. The RK-25 plate pickup coil is three to five turns of No. 20 hook-up wire slipped around the exciter plate coil, for different bands will need different settings of this link coil.

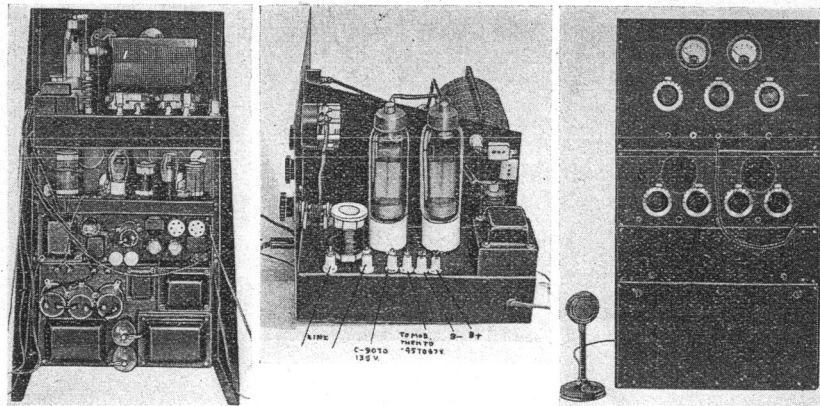

FIG. 5—Two RK-28s in the "final" and 80-160 meter plate inductor.

The final amplifier is illustrated in Fig. 4. Left to right is the grid coil, and 100 mmf. Hammarlund condenser (this can be the 325 mfd. antenna condenser removed from the exciter as the outfit grows). The two (or one) RK-28s, the filament transformer and the McMurdo Silver 17E RF choke—really big enough for a man sized kilowatt. To the right of the partition is the 9000 volt plate condenser of 100 mfd., the 350 mfd. 3500 volt antenna condenser, and the Johnson high Q inductor for 20 and 40 meter bands. If you don't believe that 500 RF watts do not

need a 9000 volt plate condenser, just unhook the antenna and watch the 3500 volt antenna condenser arc over when no load is across it!

RK-28 screen voltage is taken off the oscillator-modulator power unit. However, when this is done, the air gap of the choke has to be doubled, for even though it's only feeding the 6A6 and one RK-25, it has to shell out 150 MA to the RK-28 screens, which drops its total voltage to 400 to 450 volts—okay for the exciter, and just right for the RK-28 screens.

(Continued on page 36)

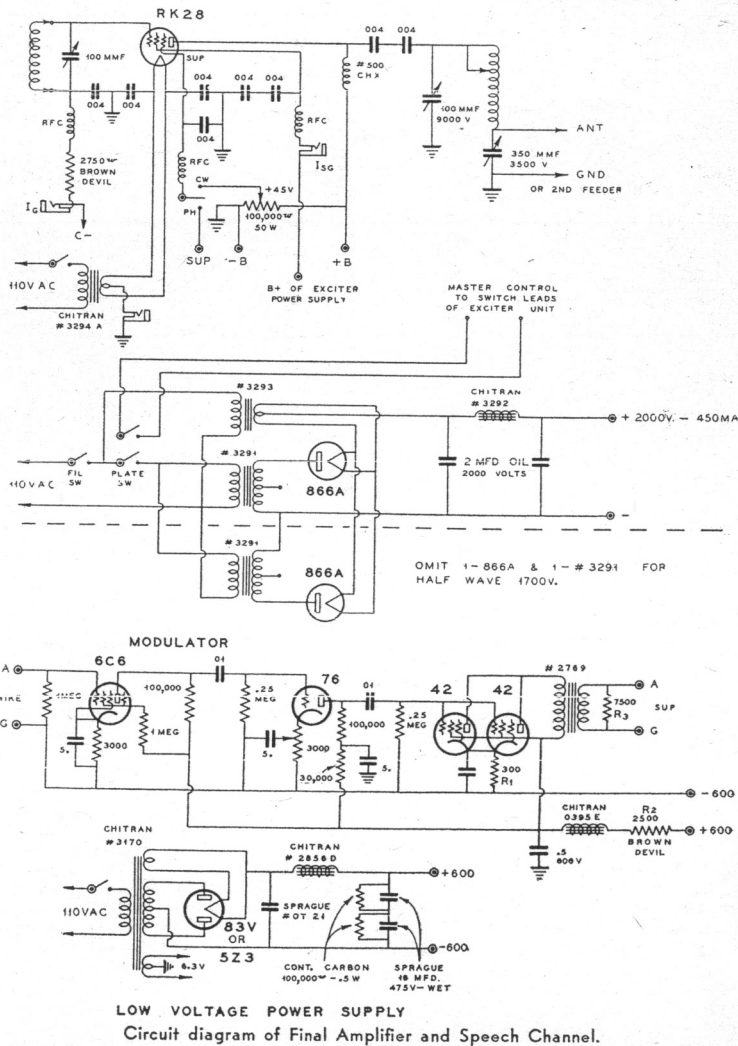

50-Watt Suppressor Modulated Phone

Quick Band Changing—No Buffer Stage—No Neutralizing

By FRANK C. JONES

● The RK28 and 803 RF pentode tubes make possible the construction of a very simple phone transmitter which requires no neutralizing and has relatively few parts. Band switching works out very satisfactorily. The transmitter here described can be operated on phone or CW on 80, 40 or 20 meters with only a few seconds' delay in switching and tuning for resonance. Even though the large pentode is more expensive than other types of 100 watt tubes, the saving in parts and the elimination of a buffer stage almost offsets the tube cost.

A good, strong crystal oscillator-doubler such as a 53 or a 2B6 will drive an RK28 or 803 pentode to full output on 80, 40 or 20

40 meter crystal will drive the final to nearly 200 watts output on 20 meter CW and 50 watts of phone carrier. On the other bands the output is slightly higher.

The 53 tube uses one triode as the crystal oscillator with a 24 turn coil of No. 18 enameled wire on a 1/2-in. diameter coil 1 1/4-in. long, tuned with a 100 mmfd. midget condenser. When this circuit is tuned to 40 meters for the 40 meter crystal, half of this coil is shorted-out by means of an ordinary on-off snap switch mounted just beneath the tuning dial of this circuit. All controls are on the front panels.

The frequency doubler or quadrupler section of the 53 uses regeneration in order to obtain good efficiency, especially when quadrupling. A small 3-30 mmfd. semi-adjustable trimmer condenser is mounted alongside the coil socket, and only enough capacity is used to provide regeneration below the point of self oscillation. This is easily checked by putting the final in operation and setting the crystal switch between contact points. No output for any dial setting should result.

Capacity coupling from either section of the 53 provides grid coupling to the pentode. A 100 mmfd. midget variable condenser acts as a control of grid excitation. The condenser is fitted with an extension shaft and knob on the lower edge of the top panel. Either section of the 53 is used, depending upon whether straight-through amplification of the crystal fundamental is used, or if one

The pentode plate circuit consists of a simplified pi network for reducing harmonic radiation when used with a single-wire-fed Hertz antenna. Any length of antenna can be used, but infinitely better results are secured with a 132-ft. antenna, used with a single wire feeder off center. This length is a compromise, being a trifle long for 75 meter phone, but it is the correct length for 80 meter CW, 40 and 20 meter CW and phone. The feeder will radiate somewhat when the antenna length is incorrect; thus the feeder should be kept clear of all nearby objects. A good ground connection is desirable, one consisting of several 4-ft. ground rods driven

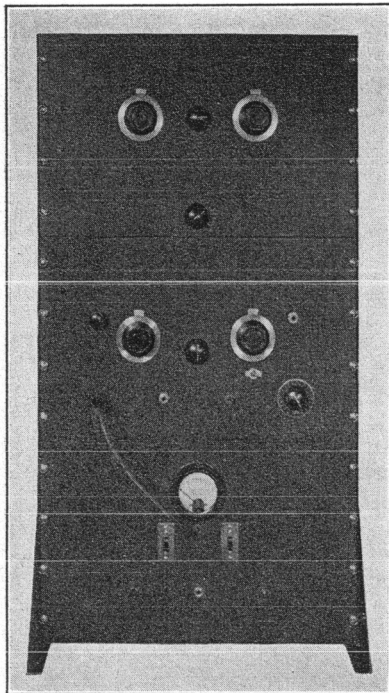

Front panel view.

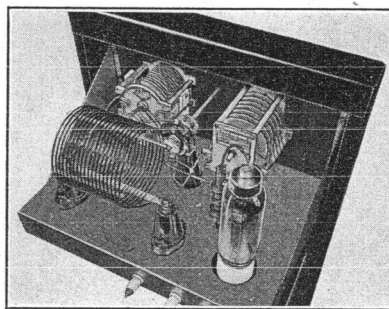

Close-up of Final Amplifier.

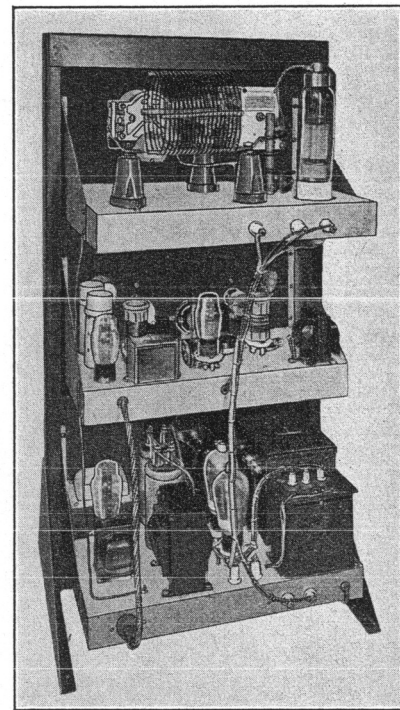

Rear view of the complete job.

meters. If a low powered crystal oscillator is used, a doubler and also a buffer stage is generally required; 2 watts of driving power is supposed to be all that is needed for the pentode RF drive, yet double this value is usually needed. Impedance mismatch, coil losses, grid-leak heat loss and switching losses all contribute to a loss of power, and thus an output of about 3 to 6 watts is required. The 53 will put out 5 watts as an oscillator or doubler, therefore ample power is available when its plate supply is not less than 400 volts.

An Ohmite band-changing switch is used to switch-in three different crystals, one for 80 and 40 meter CW, one for 75 meter phone and a 40 meter crystal for 40 meter CW or 20 meter phone. The 80 meter CW crystal will also serve on 20 meter CW, quadrupling in the 53. The drive is sufficient for 150 watts of CW output on 20 meters from the pentode when using an 80 meter crystal, but is a little lacking for 20 meter phone. The

of the harmonics are wanted. Switching over to the crystal section requires less tuning capacity due to the added capacity of the RK28 grid circuit. Generally the second section of the 53 is tuned to resonance on the second harmonic, as indicated by a sharp dip in cathode current of this tube, in order to keep this total current around 50 to 60 MA.

The doubler section uses a 140 mmfd. midget variable condenser for tuning in order to cover both the 20 and 40 meter bands without coil switching. This means the low C is used on 20, and high C on 40, but since there is more than ample output on 40 when doubling, this high C tuning arrangement is satisfactory. Regeneration is obtained by connecting the plus B tap 3 turns from the grid end of the coil. This coil has 10 turns, 1 1/4-in. long, of No. 16 enameled wire on a 1/2-in. diameter form. The pentode must feed from the plate end in order to obtain best impedance match and consequently greatest grid drive.

into the ground 10-ft. apart and inter-connected, being very satisfactory. A water pipe ground is next best. A good ground connection is desirable for receiving and time is not wasted in arranging a good one.

The plate circuit is tuned by a 100 mmfd. 6000 volt condenser. The coil and antenna condenser complete this circuit, resonance always being obtained with the 100 mmfd. condenser. The other condenser is used to obtain proper antenna loading. A low impedance antenna requires more capacity than given by the 225 mmfd. (3000 volt) condenser and a .0001 or .00025 mica 5000 volt condenser should be shunted across it, right at the condenser. This is not usually necessary with a single wire feeder, but if any odd length of antenna wire is used, this fixed condenser connection may be necessary. The coil for the final stage consists of No. 10 wire on celluloid strips, 4 turns per inch, with 19 turns total on a 4 1/2-in. diameter. The 20 meter tap is at three turns, and the 40

at 8 turns. The switch short-circuits all of the other unused turns so that at 20 meters only 3 turns are left in the circuit. For this reason the Ohmite switch is mounted right beside the coil in order to have very short leads. An extension shaft and knob provides front panel control.

All by-pass condensers on the filaments and grids are connected together at the socket and to a common ground point on the chassis. The control grid has a 5000 ohm grid-leak and small RF choke for shunt feed of bias. This provides approximately half of the grid bias.

Two power supplies provide all of the necessary voltages. A 400 volt supply furnishes 50 to 60 MA to the 53 tube, and from 60 to 70 MA to the pentode screen. It also supplies 250 volts to the speech and modulator through a 6000 ohm 20 watt resistor. The main voltage divider across the 400 volt supply provides various bias voltages for the pentode tube grids. The negative B lead from the 1800 volt supply and 10 volt filament center-tap connects to a point about 50 volts above ground potential on the voltage divider. The latter is made-up of individual resistors mounted underneath the middle chassis. This gives an additional 50 volts to the control grid so that it runs with excitation at negative 100 volts. It also provides negative 50 volts to the suppressor grid when the switch is thrown to phone position. On CW the suppressor grid should be about plus 50 volts with respect to its filament, therefore another tap further up gives this voltage. This tap is actually 100 volts above ground, but only 50 volts as far as the RK28 tube is concerned. The plate current of the pentode does not flow through any part of this voltage divider.

If the power supply gives exactly 400 volts, this leaves 350 volts supply to the screen, which is suitable for the RK28, but a little low for the 803. The 53 tube can be driven with 450 volts, leaving 400 volts for the pentode screen supply if desired. The actual value of this voltage will depend upon the AC line voltage and upon the DC resistance of the two filter chokes in this supply. If the swinging choke has a resistance of less than 100 ohms, and if the other choke has less than 200 ohms resistance, the output voltage will be over 400 volts when a 500-500 volt transformer is used with an 83 or 83V rectifier. Series electrolytic condensers provide a factor of safety at this voltage commensurate with long operating life.

The high voltage supply has condenser input because the current drain is not over approx. 150 MA and higher voltage is available from standard transformers on the market. The negative B current measuring jack measures only the plate current to the pentode tube. Both an 803 and an RK28 tube were tried, both operated with from 60 to 75 MA of plate current on phone and 110 to 130 MA on CW. The 803 requires less plate coil inductance, due to its larger plate-to-ground capacity. The RK28 is more suitable for 10 or 20 meter operation due to its lower output capacity. The 803 seems to be a little easier to drive, but its output is slightly less than an RK28. The high voltage is shunt-fed through a 200 MA section wound RF choke. .002 mfd. 5000 volt condensers connect to each end of the choke, one to ground and the other to the tuned circuit.

The modulator unit consists of a 2A6 high mu tube input stage for crystal microphone input, a 56 resistance coupled amplifier and a 2A5 pentode modulator. The microphone jack, grid lead and the first two tubes are all shielded to prevent RF pick-up. A 1-to-1 ratio output transformer, with a 10,000 ohm resistor load, feeds audio output to the sup-

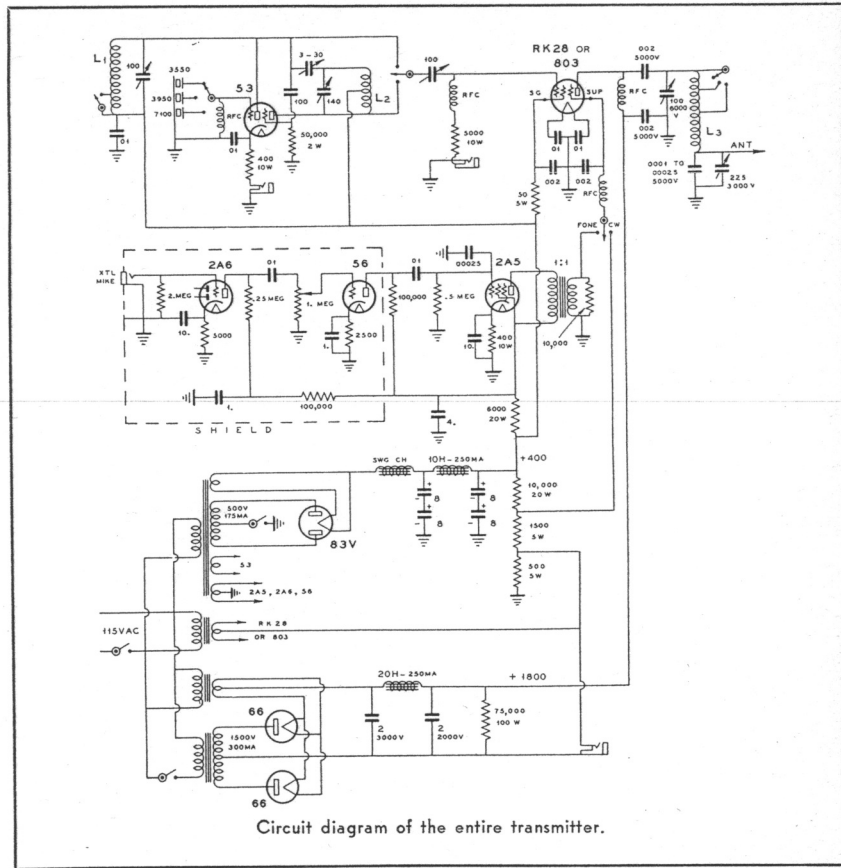

Circuit diagram of the entire transmitter.

pressor grid of the RF pentode. The values of resistors and coupling condensers shown are satisfactory for excellent voice quality from a diaphragm type crystal microphone. The 56 stage could probably be eliminated if a double-button carbon microphone is used.

A carrier shift indicator consisting of any diode tube, RF pick-up coil or lead, and a 0-1 milliammeter should be available at all times to check over-modulation. It was found that the RK28 would modulate properly when 9 to 12 MA of DC grid current was flowing. The 53 tube supplied 12 MA on 20 meters, 13 to 15 on 40 meters and 14 to 18 on 80 meters.

The transmitter shown is mounted on a 3-foot relay rack. Three 1-ft. No. 14 ga. panels hold the three chassis and controls. The chassis are of 20 gauge steel with corner end supports for bracing to the front panels. The top and bottom decks are 12-in. x 17-in. x 2-in., and the middle deck is 9-in. x 17-in. x 2-in. The lower deck holds the high voltage power supply, the low voltage transformer, rectifier and first filter choke. The second deck holds the remainder of the low voltage filter on the end opposite to the audio amplifier. The 53 crystal oscillator and doubler circuits mount in the middle of this deck. The top deck holds the final amplifier.

The grid circuit of the final stage is shielded from the output circuit by the chassis. The five-prong socket is mounted on standoff insulators below the chassis which has a hole cut in it for the tube.

The new low temperature-coefficient cut crystals should be used because the 53 operates at fairly high power, which would cause some frequency drift with ordinary x-cut crystals. The total "wholesale" cost of all parts including tubes, crystals and microphone would be approximately \$190.00.

10-Meter Grid Drive Notes

The discussion of grid circuit RF drive in last month's issue was intended to cover only the operation on 20, 40, 80 and 160 meters. The method used to obtain easy grid drive under load was to by-pass the center of the split plate coil, even when a split-stator plate tuning condenser is used. However, this arrangement seems to cause a regeneration effect under load, with the result that the grid DC current remains nearly as high, or higher, than when no plate voltage is applied.

The circuit is suitable for operation at wavelengths of from 20 meters up, without excessive trouble from self-oscillation. On the other hand, the circuit is not stable when used for 10 meter operation, and certain changes must be made, as found by W6BAY.

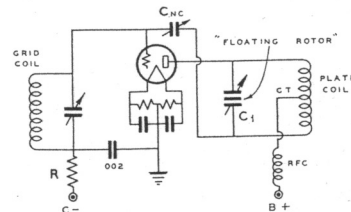

The accompanying diagram shows the proper use of the circuit for 10 meter operation. Complete neutralization is secured. Other tests on 10 meters also indicate that the coil should not be by-passed to ground, as is done when the circuit is used for operation on the lower frequencies. Low-C tubes can be operated at higher frequencies without instability than high-C tubes when the plate coil center tap is by-passed to ground. High-C tubes could be classed as those having inter-electrode capacities higher than 7 mmfd., input, output, or grid-to-plate.

Brick-Bats From Readers

● The editors of "RADIO" recently pledged themselves to print communications from "friend or foe". Our fan mail brings hundreds of letters of praise, few of other kind. Each letter of criticism will be published, unless the writer thereof refuses permission to reprint. Following are the brick-bats received during the past 60 days. (Letters of commendation will not be printed . . . much as they are appreciated.)

A Scoop

● Post card from a Warner supporter, Llewellyn Joy by name. Says he:—"Dear Sirs:—Just wrote Warner a card assuring him of my confidence and support. Here's one to you to say:—For heaven's sake lay off Warner! He's done more for Ham Radio than any of us out here. He writes like a gentleman and shows he can 'take it' like a man. Maybe he's made mistakes. Maybe not—but you haven't got a better man. If you don't put out a darn good magazine I'd forget about you. But I'm a regular reader and I'm tired of your obvious bid for circulation. (Signed) Llewellyn Joy."

Editor's Remarks:

- (1)—Warner will probably welcome receipt of the card.
- (2)—Warner may be able to "take it", but we doubt if the hams can.
- (3)—Believe correspondent Joy will have his card printed in Correspondence Section of QST pretty soon.
- (4)—"RADIO" is published for Amateurs who think for themselves.
- (5)—"RADIO" makes no bid for circulation. Must sell on merit, otherwise we go broke. Only 4 or 5 pro-Warner letters received in year. Not enough to persuade us to change our policy.

On the Spot

● Walter Bradley Martin, W3QV, Roslyn, Pa., writes to Sumner B. Young protesting the article in November "RADIO", "Shuffling the Cities", not factual. Says W3QV:—"The truth of the matter is that this ruling was brought about by Amateurs in the Atlantic Division, through their Director, Dr. E. C. Woodruff, and was the result of a group of Amateurs keeping the Atlantic Div. Convention in the northern part of the Division four successive years and not moving the city in which the convention was held at any time to the southern section. The point of the next convention was voted upon by the delegate to the convention that a majority could always be had from the Area in which the Convention was being held. The establishing of this ruling was opposed by Hartford (and am in the possession of the correspondence to prove same). Please do not construe this to be any defense of Warner or anybody else, but from your writings have been impressed that you are sincere in your criticism, and should you at any time discuss this subject it is better that you have facts, and not fancies with mis-information. The whole story is a long one and rather revolves around petty politics CW and Phone, which have always opposed the CW or any division of AMATEUR RADIO as weakening the entire structure. Personally use both Phone and CW, and believe in a democratic method of governing our own body of amateurs, after electing a director to cooperate with him whether you opposed him at the election, or were for him."

Editor's Remarks:

Thanks, Mr. Martin. Mr. Young asked me to reprint your letter in full, but I have used only the high-spots. In your opening paragraph you said you did not believe the editors of "RADIO" were interested in fact. Not so, OM, we thrive on fact; we INSIST on fact before we publish our findings. This matter of refusing the Amateur permission to hold conventions only at such places as will be designated by Hartford, or by a Director, did not sit well with us. An Amateur from Spokane dropped in on us, told us of the "sour" reaction the announcement had up there in the Pacific Northwest. Those Amateurs up there are a tough, two-fisted lot. They did not want to be told where THEY could hold their conventions; not as long as they bought the tickets and supported the affair generally. Further discussion of the scheme with Amateurs locally brought this remark—"We will convene where the majority chooses . . . where it is easiest and cheapest to get to . . . where we can meet the largest crowd of fellow 'hams' . . . where the most SUCCESSFUL conventions can be staged . . . not where Hartford or a Director chooses to whisk us." The great majority of Amateurs are not members of ARRL, yet they take in the various ARRL conventions, often contribute more to the financial success of the affairs than do the ARRL members themselves, merely because they outnumber the ARRL members. Probably the unorganized majority out here would not patronize a convention which was a known "chosen spot" for a Hartford coup. The tricks of the trade as practiced by the Warner men here have been denounced time and

again by the unorganized majority which has refused to pay tribute to bossism. But in your case the situation seems unlike that which holds away out here. We can see your point. A majority of the Amateurs would continue to keep your convention in one part of the state, because of numerical voting strength. We haven't had to buck a similar condition out here. The "hams" seemed to take it for granted that when one convention is held in the northern part of the state, the next goes to either the southern or central portion of the state. It has not been a matter of deciding whether the convention would be held north or south, it was simply a matter of determining in which city in the northern, central or southern section of the state the next convention would be held. Thus it is obvious that a condition which is non-existent on the Coast is existent in the East. You can see why the fellows out here objected to the method of allocating convention spots. We've had no dissection on this score, and we didn't want to be told where we HAD to go. Consequently the editor begs pardon for failing to visualize the conditions as they exist in your State. When "RADIO" errs, its editor apologizes. No alibi is offered. The reader is Judge and Jury of what is here printed. Believing the method of rotating convention locations was an accepted practice in other States, "RADIO" vigorously protested the new scheme as announced at Spokane. Perhaps the "command" struck too close to home.

Believes Warner Was Forced to Give Frequencies Away

● The third, and final, brickbat of the late fall season comes from F. Brooks Herman, Jacksonville, Florida. Here is his letter:

In the August issue of "RADIO" you claimed that you would publish all letters for or against your cause. To prove this, please publish this letter WITH ANSWERS TO ALL QUESTIONS.

You claimed that the authorized representatives of the ARRL at the 1927 Radio Convention, gave away all of our frequencies except those we now have. Now, how could you say that when the representatives had no vote at that or any other convention? They were there only to watch over the convention and to try to persuade the U. S. Government Representatives to vote in their favor. These ARRL representatives were hams, and why should any ham give away all that territory when at that time the state of the art was not nearly as far advanced as it is now and everyone used self-excited rigs? You speak of motives behind these actions, well what motives? If you ask me I would say that those representatives were forced, by COMMERCIAL INTERESTS, to give up ALL THAT TERRITORY or get none. It was only a matter of compromise, because if the commercial interests had not been considerate they would and could have taken all the frequencies, and then where would be now? If we do not watch our step we will soon have what we have taken away from us. Commercial Interests of other far outnumber those of our country. We had better leave well enough alone; although I agree with you that we could use a lot more territory to better advantage than just sending V's.

You have no definite proof against K. B. Warner, (ARE YOU JEALOUS OF HIS SALARY?) so why not lay off until you do? You mention that Warner had motives behind his actions; well what are they?

I will close now and expectantly await to see this letters with answers to the questions in the soonest possible "RADIO".

Sincerely yours,
(Signed) F. BROOKS HERMAN,
W4CBZ.

Editor's Remarks:

You ask why our Amateur frequencies were given away. Thousands of other amateurs have long wanted to know. The court record shows that "the authorized representatives (of the Amateurs) relinquished most of these frequencies for commercial development." Warner still seems to be of the opinion, judging from his very recent writings, that he secured for the amateurs all the frequencies they could ever use. He believes he didn't relinquish very much. Every time I turn on my ham receiver and tune over the 40 or 80 meter band of an evening, listen to the confusion, the awful QRM, and when I look back to the days before Warner was "discovered" as the spokesman for Amateur radio, it makes me wonder how any living person, without supernatural powers, could predict, years ago, that bands of Hoover width would be adequate for all time to come. The way of the prophet, like the man who predicts the weather for the newspapers, is a hard one. You don't always get the kind of weather the newspapers feel like giving you. Lack of vision of the tremendous growth of Amateur radio, FEAR, INEXPERIENCE . . . and, for good measure, LACK OF INTEREST on the part of the amateurs generally, resulted in the deplorable conditions which were later brought about. "RADIO" simply maintains that Warner was NOT THE MAN to guide the destiny of all of amateur radio at that, or any other, conference! We are not



trying to "get anything on Warner". We simply print a lot of information you don't get from Warner's pen, and we leave it to you to decide whether or not Warner was, or is, the man the Amateurs need to FIGHT for their salvation!

If you agree with Warner, if you believe "no change" was brought about by the Madrid Treaty . . . if you believe that the difference between handling 3rd-party message traffic, and NOT BEING ALLOWED TO HANDLE IT BY LAW constitutes "no change" in our communications regulations, there really isn't much we can tell you to help prove that there WAS a DECIDED change. Warner went to Madrid, came back, told us about the beautiful paneled walls of the conference chamber . . . and published the startling news that THERE WAS NO PRACTICAL CHANGE IN OUR COMMUNICATIONS REGULATIONS. The Amateurs who are NOW barred from sending 3rd-party message traffic seem to "sense" a change . . . because they can't do what they used to do. Madrid put a stop to the 3rd-party traffic. You answer the question, OM . . . "was there a change?" . . . the answer is a three-letter word . . . "YES!"

Now for the Warner motives. You seem to confuse this issue with others of a different nature. We spoke of Warner's financial motives, and we published figures to show that he had secured more than \$40,000.00 in commissions from ARRL memberships and profits from QST, over and above his salary. When he threw the ARRL open to anybody who sent the necessary membership subscription fees to Hartford, his commis-



sions mounted as the membership rolls increased. In came the hodge-podge, INTO AN AMATEUR'S LEAGUE IT CAME, the commercials, some who were FIGHTING the Amateurs, many who had no desire of ever becoming an Amateur. And every time a membership subscription fee was paid, Warner got his cut.

How do you think the old-timers felt when they saw the doors of their league thrown open to all comers? Can you blame the old-line staunch supporters of Amateur radio for their protests? Try this on your neighbor next door: Ring his doorbell, whisper into his ear that he can become a MEMBER of a radio Amateur league by merely sending \$2.50 to Hartford for a membership in ARRL and a subscription to QST. First thing friend neighbor will probably tell you is that he

(Continued on page 31)

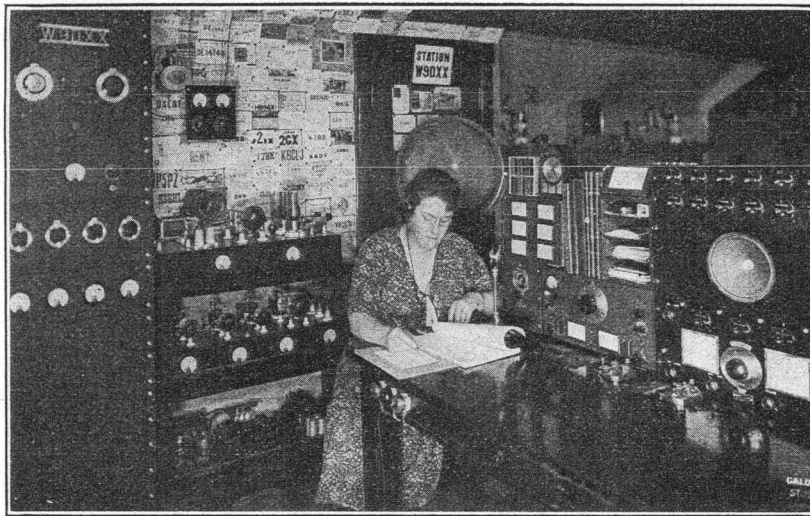

W9DXX . . .
Alice R. Bourke

From Police Reporter to Radio "Ham"

By ALICE R. BOURKE, W9DXX

• So you want a story about the operating activities and new equipment at W9DXX for the Christmas issue of RADIO?

Your airily written request was a rather large one—"Tell us about your rig. Give us the YL reaction to HAM Radio. Jot down some of the human interest stuff about the amateurs you QSO, how you got your Class A ticket, information about your skeds, and some from-life experiences with the ham crowd."

Well, here goes!

This year, in late spring, the radio apparatus at W9DXX was moved to enlarged quarters, and since then the station has gone through a series of changes, modernization and construction. The photograph shows the present appearance of the "business corner." While the shack occupies a big room, the radio equipment is concentrated in small space, so that everything is within reach of the lazy operator.

To the left of the photo is shown the most recent addition to the shack, a new 14 MC transmitter.

This is a combination phone and CW assembly, with a pair of Eimac 150Ts in final. Built primarily for brass-pounding, this rig is operated normally at 750 watts input, with plenty additional power in reserve, should it be required.

This transmitter was christened most pleasantly. The first QSO was with F8EO, who was CQing, and it was sweet music to have François tell me that my sigs were better than he had ever heard them before!

Next in the photo, comes the 7 MC transmitter. This push-pull hookup has a pair of 203As, driven by a 203A, in the final. Input varies from 400 to 650 watts, as desired.

This rig is built in sections, permitting the first stages, feeding into a single 203A, to be detached at will. This unit is carried back and forth as a portable, and operates occasionally from Americus, Georgia, during the winter.

The operating table holds a National AGSX and a National HRO.

So far as efficiency is concerned, W9DXX gets out quite well, foreign reception reports being very satisfactory.

All 48 states of the U. S. have been worked, and DX includes CE, CM, D, EA, EZ, F, G, GI, HB, HH, HJ, K4, K5, K6, LU, LY, NY, OA, OE, TI, VE, VK, VO, VP2, VP4, X and ZL. Signals have been reported on from EI, HC, K7, PA, SP, U and ZT.

A small portion of the W9DXX QSL collection appears in the photo.

My Class A ticket was obtained a short time ago, in order to maintain a single 14 MC phone sked. My parents spend the winters in the south, and the only ham within 35 miles is a microphone man.

I am a dyed-in-the-wool CW enthusiast. I never could see the fun in spending countless hours whistling sadly into a mike, or solemnly droning out: "One-two-three-four, one-two-three-four."

I realize that the preceding paragraph will be read with fury by the modulation fiends, and that it undoubtedly will alienate the affections of many estimable OMs, chummy enough to include nice 88s on their QSLs, but "them's my sentiments." Didja ever hear the one about trying to teach an old dog new capers?

Reaching the point in this request-number where "human interest stuff" is indicated, I must pull up short and consider word limitations, so far as this article is concerned, because I have found my fellow-hams to be the most human, helpful, straight-shootin'est gang on earth.

Although I procured my ham license in April, 1930, my work prevented plunging into the QRM until about two years ago. In spite of the fact that I had been chasing bullets, bombs and bandits as daily, hum-drum routine, in connection with my Chicago Tribune job, I was just about scared to death at the thought of going on the air.

I shall never forget the gracious patience, and the hearty cooperation showered upon me, when I finally worked up enough courage to tap out a shaky CQ with the juice turned on.

Some months back, in one of the radio periodicals, I read a contribution in the Vox Pop column, which complained that the good operators would not work a lid. My own debut proved the exact opposite to be true, and I am convinced that my courteous treatment represented the regular run-of-the-mine brand of kind-hearted hamdom.

None of these splendid, tolerant chaps who helped me through my kindergarten dots and dashes had any suspicion that the stumbling end of the QSO was not the "OM" whom they patted on the back so amiably.

I want to earn my right to belong to

hamdom by being just one of the gang, hence the "OMs" directed to me over the air almost always remain uncontradicted, except in the case of foreign QSOs. (Yep, you guessed it; I gotta weakness for QSLs!)

In addition to revealing the unflinching willingness of the average ham to lend a hand over the rough places, my mumness about not being an OM has given me an additional reason for admiring and respecting my brother hams. Meeting them on common ground, they have revealed themselves as a wholesome, clean-thinking, clean-speaking group. If I wasn't so doggone selfish about not wanting the amateur bands more hopelessly QRMD than they are, I'd like to hire a bus—preferably one of those spiffy-looking ones with the fascinating kitchenette accommodations—and tour the high-ways, telling the mothers and fathers of America how happy they should be if their Johnny or Cuthbert displays leanings in the direction of coils and condensers.

I owe a rather-unique personal debt to Ham Radio.

My newspaper work always was performed between evening and 3 a.m., at which time the final edition was put to bed. I slept during the day. As time went on, my abnormal working hours inevitably placed all friendships within the field of my work.

I was forced to terminate my newspaper activities due to family illness, and was kept busy for many weeks until my patient got well. Then, when the OM returned to the office, leaving me all alone in a large house, I made the sad discovery that so far as friends were concerned, I might just as well be shipwrecked on a desert island.

All my buddies were night reporters and cops. I wouldn't be seeing them any more, and I couldn't even have a rag-chew on the phone, because we were not awake at the same time!

Well, the Old Gal was dazed by the great gobs of peace and silence which hovered so persistently around her QRA. Enough was enough! Something had to be done about it!

Uh-huh; you've guessed it. Ham Radio re-hung the sun in heaven; it provided a dozen friends for each of the ex-buddies, and it brought back the accustomed all-night vigils, waiting for something good to turn up. I am happy to state that I now sleep less than ever!

Friends? Honestly, I wept genuine tears

(Continued on page 36)

90-Watt CW Transmitter

... And Some Important Data on Doubling, Neutralizing and Coupling

By FRANK C. JONES

● The CW transmitter here illustrated uses the circuit shown in Fig. 1, with a simplified antenna matching network. Grid neutralization must be used in this system; it proved to be satisfactory even on the 20 meter band with parallel tubes in the final amplifier. 90 watts output is secured on 20 meters, and about 100 watts on 40.

The crystal oscillator-doubler uses a 53 tube. When operated at 400 volts plate supply, the output on the second harmonic is ample to drive a single 10 or 53 doubler-buffer stage to good output. There is nothing tricky about the circuit nor the adjustment of the oscillator. Its normal cathode current is 60 MA when loaded and tuned for maximum stable output. One triode is used as a crystal oscillator with cathode bias, important in that it keeps the crystal RF current within reasonable limits. Grid-leak bias for a 53 is not as satisfactory as cathode bias. The other triode of the 53 is used as a doubler. Additional bias is obtained by means of a 50,000 ohm grid-leak, which should be of the carbon 2 watt type. A wire-wound leak usually requires a RF choke in series with it.

Capacity coupling to the buffer stage is entirely satisfactory, and either a .0001 or .00005 mfd. grid coupling condenser can be used. When this buffer is used as a straight amplifier, the neutralizing condenser must be set for proper neutralization, but when the stage is used as a doubler this capacity should be increased to about twice the value used for neutralization. In this case, the plate current drops from 110 MA to 75 MA, and more grid current is obtained into the final stage when the larger capacity is used. Too much capacity will cause oscillation, but the amount of capacity required will depend upon the value of grid tuning condenser capacity and plate circuit loading. No trouble should be experienced from undesired oscillation in this doubler stage. Regeneration improves the efficiency of the doubler by at least 50%.

Link coupling to the final amplifier results in a balanced circuit condition with maximum transfer of power from the buffer or doubler stage. A one-turn loop around the center of each coil gives ample coupling. The type 10 tubes are grid neutralized, using the grid meter as an indicator for dip when neutralizing. The circuit is neutralized when no grid drip is noticeable when the plate condenser is tuned through resonance, without plate voltage or antenna load applied. All tuning condensers, except the antenna condenser and two oscillator midjet condensers, are double-spaced midjets. The antenna condenser is an old BCL tuning condenser having a maximum capacity of about 350 mmfd. If a Zepp antenna is used this condenser should have a maximum capacity of about 500 mmfd.

In matching this output circuit to any antenna, less tuning capacity requires greater antenna load on the amplifier. The 50 mmfd. plate tuning condenser is used to maintain resonance, although sometimes the coil turns must be changed a trifle. The plate coil can be so arranged that one or more turns can be shorted-out by soldering short flexible strap across some of the end turns. Nearly all of the capacity will normally be required in the antenna condenser when a single-wire fed Hertz antenna is used. This sys-

tem works fairly well with an antenna of any length, one end connected to the stator of the antenna condenser. A twisted-pair feeder can be coupled to the plate coil with from 1 to 3 turns wound around the antenna condenser end of the coil.

The circuit shown is for operation with 80 meter crystals because many amateurs do not have a 40 meter crystal. A 40 meter

DC load can be drawn when choke input is used in the filter. At 120 volts AC line voltage, this power supply delivers 700 volts at 260 MA load to the transmitter. At 180 MA load, the voltage is about 750. Three 8 mfd. 450 volt electrolytic condensers in series serves as a filter condenser. Type 80 or 5Z3 tubes can be used in this type of rectifier at rather high voltages without

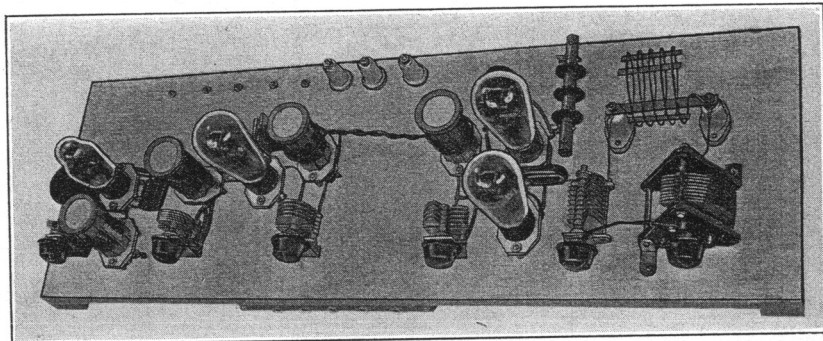

Breadboard Layout of 20-meter Transmitter.

crystal oscillator-doubler, and a 45 neutralized amplifier stage with 400 volts, will drive the final amplifier just as well as the method shown in Fig. 1 using a '10 doubler with 700 volts on the plate. A neutralized amplifier is about twice as efficient as the usual doubler stage.

A separate 400 volt power supply is need-

ed for the crystal oscillator, and a 900 or 950 volt center-tapped power transformer with choke input can be used for this purpose. A 700 to 750 volt center-tapped transformer could be substituted if condenser input to the filter is used in order to obtain about 400 volts DC at the output of the filter. The high-voltage supply uses a 1650 volt 250 MA center-tapped power transformer. Two 80 tubes are used, each as half wave rectifiers, thus for CW operation a 300 MA

flashover in the stems or other tube failure. Most all types of 10 tubes will stand 700 to 800 volts in a CW transmitter, especially if the filaments are operated between 7½ and 8 volts. Tube life is somewhat shortened, but type 10 "receiving" tubes are much cheaper than 801 tubes which have similar characteristics.

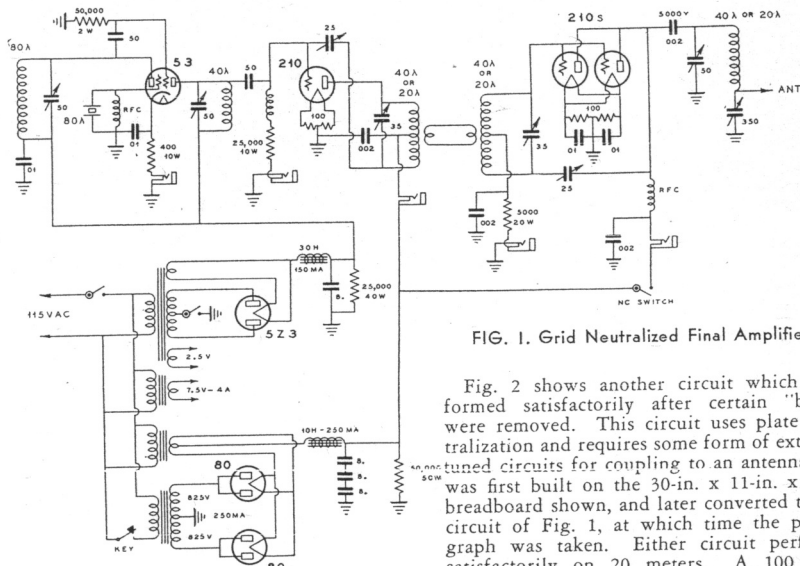

FIG. 1. Grid Neutralized Final Amplifier.

Fig. 2 shows another circuit which performed satisfactorily after certain "bugs" were removed. This circuit uses plate neutralization and requires some form of external tuned circuits for coupling to an antenna. It was first built on the 30-in. x 11-in. x 1-in. breadboard shown, and later converted to the circuit of Fig. 1, at which time the photograph was taken. Either circuit performs satisfactorily on 20 meters. A 100 watt lamp used as a dummy antenna lit up to about the same brilliancy in either case. Some rather interesting points of comparison were made, as shown in the following paragraphs.

The 53 doubler circuit was used with both circuits (Figs. 1 and 2) in the first tests. With plate neutralization, the grid current in the final amplifier ran about 22 to 24 MA with no plate voltage, and from 25 to 30 MA with plate voltage and normal antenna load. This increase of grid current only occurred when

a by-passed plate coil center-tap was used. Substitution of a split-stator tuning condenser in the final amplifier circuit of Fig. 2 resulted in a large decrease of grid current under load.

With grid neutralization, the 53 doubler-buffer would only drive from 15 to 18 MA into the final stage of Fig. 1, which was not considered satisfactory for good 20 meter operation when using a 5000 ohm grid leak for bias on the two type 10 tubes. The 53 operated at 390 volts plate supply with about 75 MA of plate current, and its triode elements were paralleled. A type 10 tube was substituted for the 53 doubler and higher plate voltage was applied with the result that 25 to 30 MA of grid current could be obtained on the 20 meter band. A type 10 tube should be operated with from 10 to 15 MA of DC grid current when it is used as a neutralized amplifier. Two tubes required from 20 to 30 MA. A 5000 ohm grid leak in this case provided nearly twice cut-off bias for Class C operation at high efficiency.

Using the circuits of both Fig. 1 and Fig. 2 good neutralization could be obtained as indicated by no flicker of grid DC current when neutralizing. However, when high plate voltage was applied, the tubes would oscillate hard, even when not coupled to the buffer stage. The stage would lock into step with the crystal oscillator-doublers, and no substitution of parts or the use of shielding would prevent self-oscillation in the final stage when high plate voltage was applied. The same trouble occurred when using Fig. 2 with a split-stator tuning condenser, and also when only one neutralized 10 tube was used. Apparently the plate voltage upset neutralization. Slots were sawed through the tube bases between prongs, and the trouble disappeared. The molded base material on these tubes was never designed for use at high plate voltages at high frequencies. Hack-saw slots between prongs removed most of this dielectric by providing an air gap between the prongs. These tube bases can be slotted if care is taken not to saw into the base more than a 1/4 inch deep, so as to not break the glass tip inside the molded base. If the bases are not slotted, they will blister in time. It does not seem possible to obtain effective neutralization under load, especially at high power, unless the criss-cross slots are cut into the '10 tube bases.

Primary keying is shown because there is no trouble from key clicks when this method is used, and the filter system here used will not put much, if any, audible "tail" on the

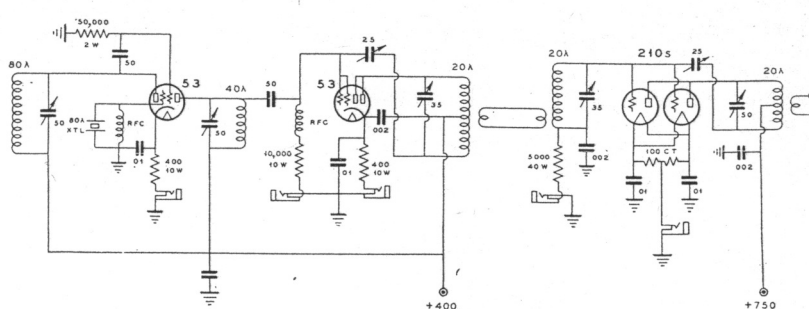

FIG. 2. Plate Neutralized Circuit for 20-Meter Transmitter. The fixed condenser connected from the low voltage B to ground should have a capacity of .1 mfd.

dots when sending. No fixed C bias is needed, and grid leak bias can be used in both buffer and final stages when primary keying is used. An ordinary telegraph key will break the 115 volt AC line circuit at this power, which is only between 1 and 2 amperes for the high voltage plate transformer primary.

Another interesting point was noted when comparing Fig. 1 and Fig. 2. The grid coil of Fig. 1 requires several turns more than that of Fig. 2. Similarly, the plate coil of Fig. 2 required about 3 turns more than that of Fig. 1, on 20 meters. These same conditions have been found in other transmitters and they can be explained by a study of effective tube capacities. Coils suitable for use in one type of circuit are not suitable for use in the other circuit. The RF output of either circuit in this transmitter, and another transmitter tested at 600 watts output, was the same for either grid or plate neutralization under the conditions of identical grid drive, plate current and plate voltage. Grid neutralization requires a larger plate tuning capacity, in addition to a much smaller inductance, in order to maintain a proper value of circuit Q under antenna load conditions, than in the case of plate neutralization. The choice of circuits often depends upon the parts available.

In using a 53 as a neutralized amplifier, the neutralizing condenser must have a very low minimum capacity because the inter-electrode capacities are low, even when the triode elements are in parallel. When it is used as a doubler or tripler, the "neutralizing" condenser should have a larger capacity, 10 to 20 mmfd., so as to obtain regeneration needed for high-frequency operation.

In Fig. 1 the tubes were run at the following values of voltage and current: The 53 oscillator-doubler was operated at 60 MA cathode current with a 410 volt plate supply. The buffer grid current ran about 8 MA, and the final at 25 to 30 MA, depending on antenna load. The 10 doubler plate current was 75 MA, and the final 180 MA on 20 meters, with antenna load. The plate voltage on these two stages was 700 volts.

In Fig. 2 the 53 oscillator and 53 doubler stages ran at 390 volts with cathode currents of 60 and 75 MA, respectively. The grid current to the 53 buffer-doubler was 10 MA, and the final about 28 MA. The final plate voltage was 750 volts, and the plate current 170 MA under load. Under no load, the plate current in the final stage dropped to about 15 MA, in each case, at resonance.

The coil data for the circuit of Fig. 1 is as follows:

- 80 meter oscillator 53—32 + No. 18 E, closewound, 1 1/2-in. diameter.
 - 40 meter doubler 53—19 + No. 18 E, spaced to cover 2-in. on 1 1/2-in. diameter form.
 - 40 meter amplifier 10—28 + No. 18 c, closewound, 1 1/2-in. diam. C.T.
 - 20 meter doubler 10—14 + No. 18 c, spaced to cover 1 3/4-in. C.T.
 - 40 meter final grid—22 + No. 18 c, closewound, 1 1/2-in. C.T.
 - 20 meter final grid—10 + No. 18, closewound, 1-in. C.T.
 - 40 meter final plate—11 + No. 14 E, 2 3/4-in. diam., 2 1/2-in. long.
 - 20 meter final plate—5 + No. 14 E, 2 5/8-in. diam., 2-in. long.
- (E denotes Enameled wire, c denotes cotton-covered wire)

News Bits—From Here and There

● Philco is now making 9,000 radio sets daily.

● Sylvania announces a 210 tube with an Isolantite Base.

● W6MPC held a ticket for a "Movie Bank Night" drawing at a San Francisco movie theatre. He preferred to stay home and operate his 5-meter set on the night of the drawing. His number was called . . . but W6MPC wasn't there . . . so he lost \$300.00. Was the QSO worth the price?

● "RADIO" has published a new booklet for beginners, entitled "The Radio Amateur Newcomer". Dealers were circularized for orders. A certain dealer wrote back and said: "Please send me 25 copies of your new book, 'How To Become A Radio Equivalent'." That's a new name for a beginner . . . or is it?

● The radio amateur club of Auburn, California, recently staged a hamfest and barbecue. The barbecue pit had to be blasted out of solid rock. A charge of dynamite was used to do the job. In the radio shack nearby was a high power trans-

mitter using a 211 tube in the final. The charge of dynamite was set-off . . . the rock blasted to bits, and also the filament of the 211. Hamfest profits . . . negative \$17.50. As "Time" would say . . . "Reason—one tube gone".

● The stratosphere balloon's ascent was reported in a news release by RCA. Said the report, in part—"however, the signals were so loud that, with the exception of one period during the flight, it was possible for the observers to copy all signals with the headphones hanging loose from the receiver." Makes one wonder how loud the signals would have been with the headphones connected to the receiver. Try it on your balloon some time.

● Excerpt from "The Aerial", hamsheet of the Akron, Ohio, Radio Club . . . "Mama, here's some more of that paper".

● Byron Goodman, W6CAL, formerly ARRL SCM of the San Francisco district, has been added to the staff of ARRL headquarters at Hartford. It is said that his job, in part, will be to rekindle the dying embers of the fire in the Warner camp on the Coast. At whose expense?

● There will be a hamfest in Fresno, California, on December 14. Place . . . The New Omar Khayyam, 927 Van Ness Avenue. The San Joaquin Valley Radio Club is staging the affair.

● New "air-wound" tank coils with copper plated and enameled steel-core wire will soon be on the market. Small diameter sizes will be available. These new air-wound coils as fast replacing the old alcohol still copper-tubing coils.

QRX

For the Great, New
"RADIO" . . .
Technically Supreme
Out Early in January

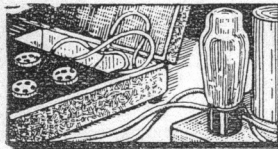

REVIEW / D of Factory Receivers

Sargent Model 20 Super

● Sargent Model 20 is a communication type superhet designed to meet the needs of the experienced operator. The AC Model uses 9 tubes, having a stage of pre-selection, individual first detector and HF oscillator tubes, two stages IF, 2nd detector, combined beat oscillator and AVC tube, pentode output and rectifier.

The circuit of this receiver has been designed with especial regard to isolation and elimination of common couplings. No less than 34 isolation resistors and individual, non-inductive, by-pass condensers have been used for the purpose of restricting the RF currents to their proper paths. The net effect of this is not only to confine the RF currents to the circuits in which they belong, but also to prevent line noise and similar interference from getting directly into the receiver circuits. Consequently, the only path by which either noise or signal can enter the receiver is via the antenna lead-in; thus the operating noise level is at the absolute minimum.

The unusual attention given to circuit isolation in Model 20 has also provided an exceptional degree of stability in the RF and IF circuits. The IF amplifier is almost entirely free from any indication of regeneration and hence will stay lined-up, despite temperature or humidity changes, for a long period of time. The same applies to the pre-selector stage.

The AVC system is an unusual one and has been designed for the special requirements of the operator of a communication type receiver. Use of the AVC is optional, there being a switch to cut over to straight manual control for telegraph work, or for those operators who do not like AVC. The sole purpose of the AVC in this receiver is to regulate fading. We quote the manufacturer of this receiver as follows:

The AVC system used in the Sargent Model 20 is designed primarily for the purpose of compensating for fading signals. Unlike most AVC systems, this one uses a 76 triode 2nd detector instead of a diode.

The use of a triode 2nd detector has many advantages. The input impedance of a triode is extremely high, making possible a sharply tuned secondary circuit in the last IF transformer as against approximately a 5000 ohm input impedance where a diode is used. The difference in selectivity in favor of the triode is considerable. Sensitivity of a triode is many times greater than that of a diode, hence weak signal response is correspondingly greater. Thus a smaller amount of IF amplification per given signal is required, resulting in less tube hiss and lower background noise.

The AVC voltage is developed by the diode section of the 85 tube, the triode section of this tube being used as the beat oscillator. The diode plates are biased slightly negative so that there is no AVC action unless the signal is sufficiently strong to overcome the bias. This is done so that there is no loss of volume on a very weak signal, the voltage from which would otherwise be divided part to the AVC and the remainder to the audio. The part operating the AVC would effect a still further reduction in volume. When the signal becomes strong enough to overcome the diode bias,

the AVC starts to work and will control fading from this point upward.

Unlike diodes, triode detectors can be overloaded with extremely strong signals. In choosing between a diode and triode for second detector the choice reduces to this: a detector which at best gives only average results but which cannot be overloaded even by unintelligent operation of the receiver as

system is mechanically operated and has the advantage of flexibility and elimination of losses at the high frequencies.

Although extended wavelength coverage is offered, no additional losses have been introduced into the high-frequency circuits by adding this feature to the receiver. Individual coils are used for each waveband, and all coils to the low frequency side of the

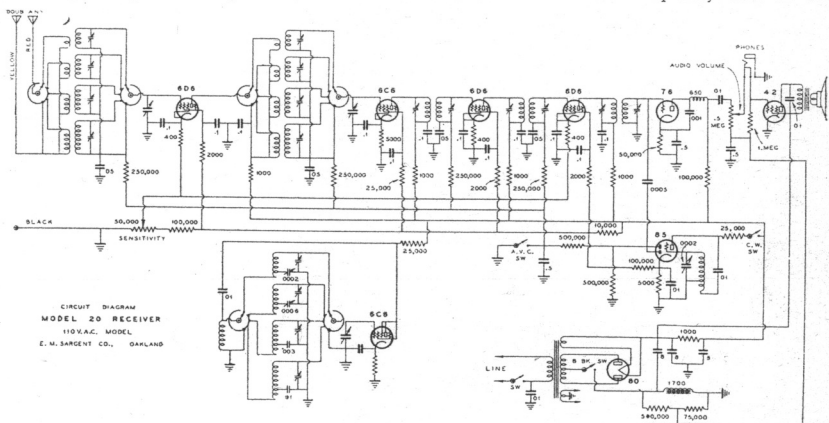

against a detector which gives the best possible results but requires intelligent operation of the sensitivity control to prevent overloading. We have chosen the latter. In doing so we have made it necessary for the operator to use the sensitivity control to cut down signals which are too strong for the second detector to handle. Thus, the AVC is in Model 20 for one purpose only—to regulate fading.

Model 20 uses the same calibrated band spread system described in "RADIO", August issue, in connection with Model 10. This one in use are shorted-out by a special sec-

tion on the tap switch. Ample spacing around coils, and good shielding, prevent interaction.

Distortionless audio power output is about 3 watts. For those desiring more, a plug-in amplifier unit is offered as an accessory. This amplifier has its own power supply and uses a 56 driver into a pair of 45s which operate a 12-in. Jensen speaker. The amplifier takes AC power and signal voltage from a plug-in socket at the rear of the receiver.

Circuit diagram of Model 20 is shown above.

Radiatorial Comment

(Continued from page 5)

when an elusive DXer is fading in and out. So why blame the DX men for protesting loudly when the RST orphan looked for a home?

The RST system is now so similar to the older and more widely used QSA-R system that there is practically no difference between the two. The RST system carries a superfluous "T" character, denoting tone, or note. The law says—"So help you, ham, if your note is not pure DC." Right? That being the case, it is evident that when you give a fellow a "T" report of 3, for example, he becomes eligible for a pink ticket from Washington, doesn't he?

Some of the die-hards will continue with the RST system, for a little while. Then it will go the way of all half-baked ideas. Instead of telling a brother ham . . . "You're pure DC xtal note, QSA 5, R 9, FB, OM" . . . just say "5-9." That tells the story. Those whose walls are plastered with DX cards, and most of those who rattle-off a wicked signal on a bug, will simply hand you a "5-9", or any other combination, because it tells the entire story.

Book Review

THE HANDBOOK OF CHEMISTRY AND PHYSICS. 20th Edition, 1966 pages. 22nd year of publication. Published by Chemical Rubber Publishing Co., Cleveland, Ohio. Price \$6.00.

The Twentieth Edition of the Handbook of Chemistry and Physics represents a 22-year accumulation of necessary data for the busy scientist and engineer that is not only acceptable but highly essential in the commercial, educational and research laboratory.

The Handbook is now accepted as occupying a field of its own, and as being the only authentic guide and reference in the sciences relating to chemistry and physics.

Constant revision, year by year, makes this 20th edition, 1966 pages, the most up-to-date data procurable.

The handbook is divided into five sections, approximately equal in size. These sections are indicated by inserts of stiff colored paper on which is printed a summary of the contents of that particular section. The separation is as follows:

1. Mathematical Tables.
2. Properties and Physical Constants.
3. General Chemical Tables.
4. Heat, Hygrometry, Sound, Electricity and Light.
5. Quantities and Units—Miscellaneous Tables.

The New Miller 2-Stage Pre-Selector

Recent tests conducted by amateurs show that the use of a Miller pre-selector ahead of a short-wave receiver brings up R-2 and R-3 signals to as high as R7 and R8. This pre-selector is a high gain, two-stage radio frequency amplifier unit, complete with power supply.

The coils are designed to cover the full range of the high frequency bands from 12 to 200 meters, and provision is made on the band switch to facilitate the incorporation of broadcast or long wave coils. The last position on the switch is the antenna through position, in which the antenna is coupled directly to the receiver.

Correct results are obtained from the completed units only when the chassis layout is similar to that shown in the photographs. The most essential single item to be observed in the design of the chassis is the metal shield located between the band change switch, RF coil, and trimmer condensers TC-3 and TC-4. If this shield is not placed in the position as shown to prevent capacity coupling between the tuned antenna circuit and the RF circuit, the unit may oscillate at various portions of the tuning range.

Another item of importance is the connecting wire between the antenna binding post and switch terminal S-1. This connection

should be of buss bar in order that it may be self-supporting and thus well separated from the associated units.

After the pre-selector has been completely wired, tubes inserted and various voltages checked, the unit should be connected to a short wave receiver covering the full range of frequencies for which the pre-selector has been designed.

With the pre-selector switch set on the "antenna through" position, adjust the receiver to approximately 15 meters and advance the volume control until the usual atmospheric disturbances are heard. Now turn the pre-selector switch to position "D"

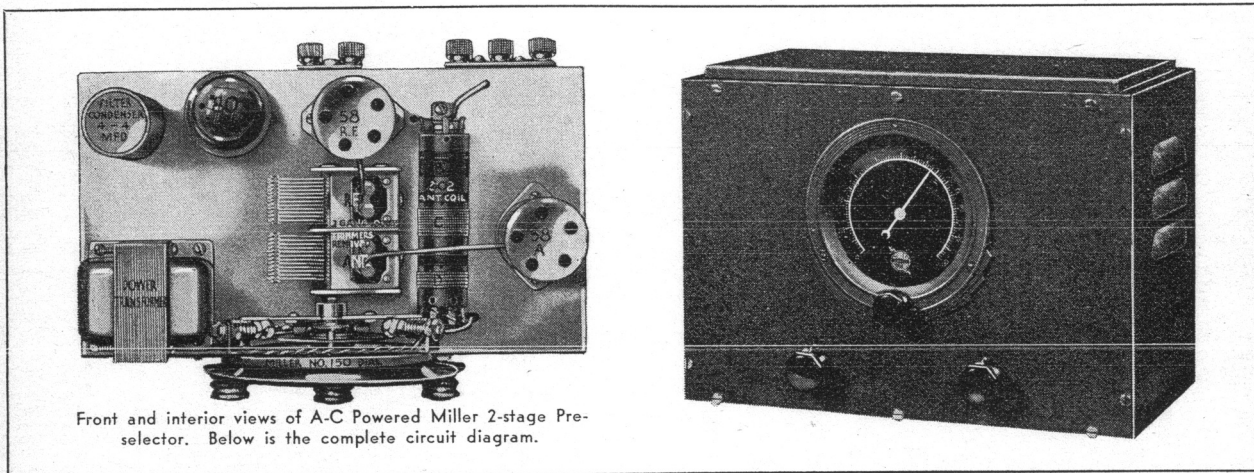

Front and interior views of A-C Powered Miller 2-stage Pre-selector. Below is the complete circuit diagram.

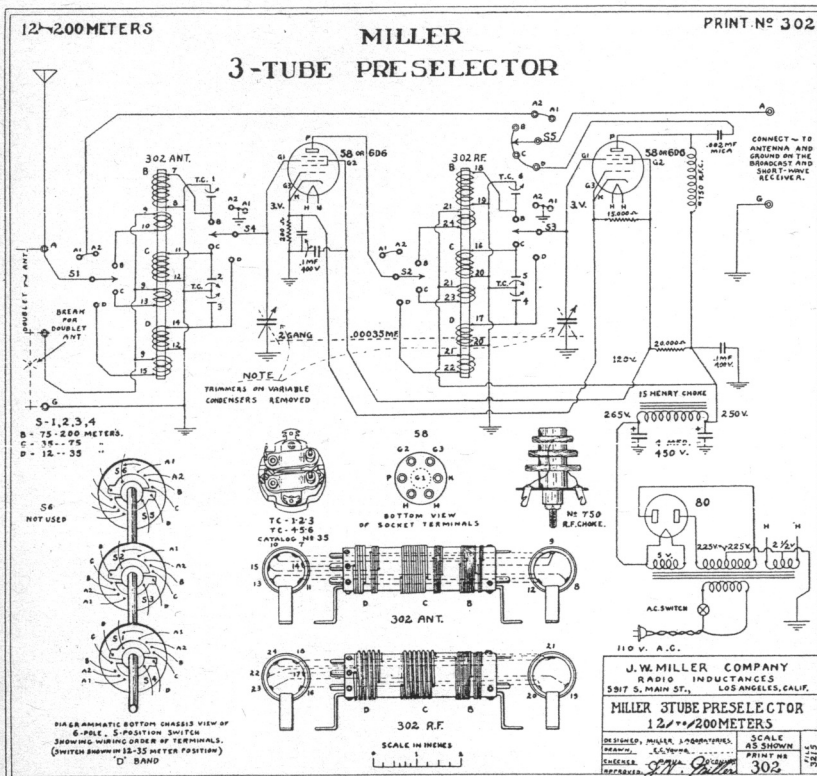

and adjust the dial to approximately 30. Adjust trimmer condensers TC-3 and TC-4 for maximum noise level. Continue by repeating this procedure on the "C" band, using TC-2 and TC-5, and on the "B" band, using TC-1 and TC-6.

Satisfactory operation will be obtained if care is taken in aligning the circuits by ear. Frequencies that are suggested as test points are: "D" band, 20,000 KC; "C" band, 9,000 KC; and "B" band, 5,000 KC, all of which are approximately 30 on dial.

For ease in locating stations, it is sometimes desirable that the pre-selector unit be turned to "antenna through" position until the station is located.

PARTS REQUIRED

Miller Pre-Selector Coil Kit, which includes:

- 1 Antenna coil
- 1 RF coil
- 1 RF choke coil
- 1 Switch (6 pole, 5 position)
- 3 Dual trimmer condensers

Other Miller parts (optional):

- 1 Metal cabinet
- 1 Dial
- 1 Pre-Selector chassis
- 1 Variable condenser (.00035) 2 gang
- 3 Wafer sockets
- 2 Tie points

Miscellaneous Parts and Tubes:

- 1 Power transformer
- 1 15-Henry filter choke
- 1 Dual 4 mfd. 450 v. electrolytic condenser
- 1 200 ohm 1 watt carbon resistor
- 1 15,000 ohm 1 watt carbon resistor
- 1 20,000 ohm 1 watt carbon resistor
- 1 .002 mfd. mica condenser
- 3 1 mfd. 400 v. by-pass condensers
- 1 Type 80 rectifier tube
- 2 Type 58 RF amplifier tubes

The Operation of Class C Amplifiers

● A class C amplifier is biased beyond cut-off and with high grid drive. The 100% plate modulating class C amplifier is a special type and must be biased to at least twice cut-off.

As the bias of a class C amplifier is increased the plate efficiency is increased, although the power gain is decreased. If the power output is limited by plate dissipation, higher bias and looser antenna coupling will allow the plate efficiency to be raised so that the DC input and RF output can be increased. If the output is limited, due to insufficient grid excitation, it may be desirable to reduce the bias and/or tighten the antenna coupling in order to increase the power gain, even at some sacrifice in plate efficiency, in order to increase the power output. A DC milliammeter is absolutely essential to indicate the grid excitation in tuning-up a class C amplifier.

If the point of minimum DC plate current does not occur at the same tuning condenser setting as the point of maximum antenna or feeder current, there is too much inductance and not enough tuning capacity in the plate tank circuit. It is impossible to obtain high plate efficiency and output unless these two points coincide. It is also quite difficult to obtain high efficiency and power output in a final amplifier unless the antenna feeders reflect a pure resistance load into the final amplifier. Get the standing waves off the feeders and cut the antenna to exact length. If this cannot be done, use link coupling between the plate tank of the final amplifier and a separate tuned antenna tank located at least five feet away from the final amplifier.

See that the DC plate current to the final amplifier with the load (antenna) disconnected is less than 10% of the normal operating DC plate current. If the minimum plate current is higher than 10%, excessive tank circuit losses are indicated, except in the case of self-bias with a cathode-ground resistor.

It is almost impossible to realize high plate efficiency and power output unless the amplifier is properly neutralized. No amplifier is properly neutralized when the neutralizing condenser is smaller or larger than the plate-to-grid capacity of the tube. The ground tap on the split tank circuit, (whether a split grid tank or a split plate tank is used) should always be at the exact electrical center of the circuit so that there is an equal and opposite phase shift on each side of the ground return. It may be possible to realize partial neutralization of the feedback voltage by placing the ground tap off-center on the split tank coil, but even though the amplifier will not self-oscillate, the change in the shape of the plate current pulse reduces the plate efficiency. The higher capacity tubes neutralize better with single section condensers and a by-pass from the electrical center of the tank coil to ground. This is due to the higher grid-to-ground, or plate-to-ground, capacity which unbalances one side of a split stator circuit.

The peak plate current in a class C amplifier can be 10 times the average DC plate current, therefore it is always good practice to make sure that the tube filaments operate with the proper heating voltage. When in doubt, it is always better to run Thoriated filaments at a higher voltage than normal.

Regeneration In the RF Amplifier

● If the DC grid current in a RF amplifier increases when plate voltage is applied to the RF stage, it is usually an indication that the stage is regenerating. This regeneration feeds plate power back to the grid, resulting in an increase in grid current. The DC grid



HAM HINTS

current in a properly neutralized stage will usually drop when plate voltage is supplied to it or when the antenna is more heavily loaded. If the RF stage is not amply shielded the antenna may feed back into a buffer stage, or into the AC line and RF portion, thereby causing an increase in grid current even when the stage is perfectly neutralized. The trouble can usually be remedied by proper by-passing and correct neutralization.

The Only Safe Neutralization Indicator Is the Grid Meter

● Hold a neon glow lamp to one end of the plate coil, and the glow will disappear when the point of neutralization seems to have been found. Now move the glow lamp to the other end of the plate coil—and it will glow again. The neutralizing condenser must be slightly readjusted in order to find the new point of complete neutralization. But move the glow lamp back again to the other end of the coil, and the lamp will glow again. You see-saw back and forth, and one end of the plate coil will always light the glow lamp, even though the lamp will not glow when held against the other end of the coil. This phenomenon is caused by a slight unbalance of the neutralizing circuit due to the capacity of the neon glow lamp and hand-capacity to ground. The correct setting of the neutralizing condenser will therefore be midway between the two settings, proving that the glow lamp is not an accurate indicator of complete neutralization. The answer lies in the use of a meter in the grid circuit to denote complete neutralization. The needle of the meter will not flicker when the stage is neutralized, as determined by swinging the plate tuning condenser over its entire arc of rotation. It is essential that the RF stages be completely neutralized, especially when phone operation is used.

Getting More Excitation

● Quite a few amateurs have found that a final stage with split-stator tuning condenser requires more grid excitation than one which uses a center-tapped-by-passed coil and a single-section tank condenser. Measurements by W8CSE indicated that the buffer stage was loaded much greater, and less grid current flowed to the final grid when the split-stator circuit was used. The split-stator circuit seemed to be about twice as hard to drive as the other. This may be a simple way of increasing the excitation on 20 or 40 meters in case you find a lack of excitation when using split-stator connection. The same condenser can be used with or without the rotor grounded. The coil center-tap should then be by-passed back to filament with a .002 mfd. condenser having a voltage rating sufficiently high for operation at the normal plate voltage used.

Tubes Suitable For Ultra-High Frequency Use

● For portable battery operated 5 meter sets, type 30, 33 and 19 tubes are most satisfactory. The 19 tube is better than the 30 tube from the standpoint of RF output as an oscillator; it is less microphonic as a super-re-

generative detector, but requires four times as much filament current. The 33 makes a good modulator or audio amplifier.

For AC operation, the 6.3 volt group of tubes is more satisfactory than the 2.5 volt group because a 6 volt storage battery and dry cell B batteries can be used for emergency operation. The 6A6 and RK34 make very effective push-pull RF oscillators and they can be used for Class B audio modulators. The 42 tube is usually better than the 41 as a detector and oscillator if plate voltages higher than 180 are used. The 42 also makes a good pentode modulator.

The 76 and 37 triode tubes are useful as speech amplifiers and as super-regenerative detectors. They can be used as low-power oscillators down to less than 2½ meters. The 6C6 or 954 pentode tubes are useful as regenerative first detectors in super-heterodyne receivers. The acorn pentode or triode tubes are especially effective from 10 meters to as low as a fraction of a meter.

For higher power transmitters, low C tubes such as the 50T are more desirable than the common transmitting tubes used on longer wavelengths.

Screen Grid Tube Facts

● The general impression that a screen grid tube has an infinite input resistance is erroneous, insofar as short-wave practice is concerned. The tube has a very decided effect on the gain per RF stage, which explains part of the loss in selectivity and gain in a RF amplifier operating at 20 meters, as an example. The minimum value of input resistance of a screen grid tube is the grid-to-plate capacitive reactance divided by half of the actual amplification gain.

If the inductance and resistance of a tuned circuit is known (plate circuit of the screen grid tube), the value of Impedance, Z_L , can

$$\text{be calculated from: } Z_L = \frac{(2\pi fL)^2}{R}$$

Then Z_{EG} formed by the plate circuit in parallel to this tuned circuit can be found

$$\text{from: } Z_{EG} = \frac{Z_L R_p}{R_p + Z_L}$$

where R_p is the plate resistance of the tube. From this the gain G can be calculated, $G = g \times Z_{EG}$, where g is the mutual conductance of the tube, 1800×10^{-6} mhos for a 6DC at normal voltages.

Taking a known value of G of 30 for a good 20 meter, 14 MC, RF amplifier, Z_{EG} can be found from:

$$Z_{EG} = \frac{G}{g} = \frac{30}{1800 \times 10^{-6}} = 16,640 \text{ ohms.}$$

This low value explains part of the loss in selectivity and gain. The remainder can be explained by the input loss obtained as follows:

$$X_C = \frac{1}{.01 \times 10^{-12} \times 2\pi \times 14 \times 10^6} = 1,130,000$$

ohms, plate to grid capacitance reactance of a type 6D6 tube at 14 megacycles. This value divided by half of the stage gain of 30

$$\text{gives } \frac{1,130,000}{15} = 75,000 \text{ ohms grid input}$$

resistance. This is across the grid input tuned circuit which shows the need of regeneration in high-frequency RF amplifiers. Some feedback to give a "negative resistance" for counteracting the coil circuit losses and the tube loading effect should always be used, if possible. Regeneration improves both the selectivity and gain of an RF amplifier, at the expense of additional front panel controls in the receiver.

EIMAC TUBES— More Power Greater Safety

The EIMAC Tube Handbook

This new 12 page bulletin contains much valuable general information on the design, construction and adjustment of amplifiers and transmitters, in addition to the characteristics of EIMAC tubes. The tube characteristics are presented in the new and exclusive constant-current charts which tremendously simplify the determination of optimum operating conditions for Class A, Class B or Class C operation. Schools and colleges are using the EIMAC constant current CHARTS for classroom projects in predicting tube performance. Instructors are invited to write for a supply of these charts. Write to your nearest EIMAC dealer and he will send you a copy.

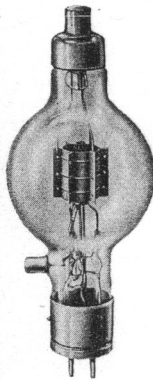

50T—Price \$13.50 Net
75 watts of available plate dissipation. 50 watts of filament heating power. Only 2.5 uufds. plate-to-grid capacitance. Filament 5-5.25 V. at 6 A. Rated plate loss 75 W. Amp. factor 13. Max. plate current 125 MA. Cgp 2.5 uufds. Max. Plate Voltage, 3000. Max. Plate Dissipation, 75 watts. Max. Class B Audio Output 375 watts. Cgf 2.0 uufds. Cpf 4 uufds. Base UX 4 pin. Max. height 7½". Max. diameter 3¼".

Plate Voltage	Class C RF Output One Tube	Class B Audio Output Two Tubes
1000	95	106
1500	140	200
2000	185	260
2500	235	320
3000	250	350

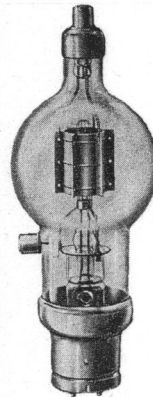

150T—Price \$24.50 Net
150 watts of available plate dissipation. 50 watts of filament heating power. Only 3.5 uufds. plate-to-grid capacitance. Filament 5 V. at 10 A.; rated plate loss 150 W. Amp. factor 14. max. plate current 200 MA. Cgp 3.5 uufds. Cgf 3.0 uufds. Cpf 5 uufds. Base 50 watt. Max. height 10 inches. Max. diameter 3¾ inches.

Plate Voltage	Class C RF Output One Tube	Class B Audio Output Two Tubes
1000 V.	150 W.	200 W.
1500 V.	225 W.	350 W.
2000 V.	300 W.	500 W.
2500 V.	375 W.	625 W.
3000 V.	450 W.	700 W.

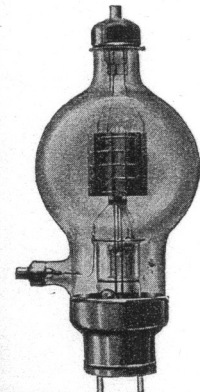

500T
Price \$175.00 Net
500 watts rated plate dissipation. 150 watts filament heating power. Filament 7.5 volts at 20 amps. Amplification factor, 15. Max. plate current, 450 MA. Cgp, 4.5 uufds. Cgf, 6 uufds. Cpf, 0.8 uufds. Base, Special Max. height, 16½". Dia. 7". Normal Class C output at 4000 volts, up to 28 MC, 1350 watts. Max. Class B audio output (2 tubes) 2000 watts. FCC Phone Rating, Class C, 500 Watts. FCC Phone Rating, Class B, 250 Watts Carrier.

EIMAC TRANSMITTING TUBES Are the Unanimous Choice of Those Who Want the Best That Money Can Buy

Unexcelled performance, coupled with a ruggedness and ability "to take it" never before found in any vacuum tube, places EIMAC transmitting tubes far above tubes of conventional design.

PERFORMANCE

The ease with which high plate efficiencies can be realized—The low amount of power consumed by the grid when excited for maximum results—The ability to place more watts in the antenna than any other tube operating under similar conditions (EIMAC performance at 1000 volts is just as startling as it is at higher voltages)—The ease with which EIMAC tubes operate even at the highest radio frequencies—The ability to produce enormous amounts of undistorted class "B" audio power—Such unusual performance is found only in EIMAC tubes and is made possible by (1) Unique grid and filament design. (2) The use of cylindrical grid and plate which allows symmetrical construction so essential for peak performance. (3) The lowest interelectrode capacities of any tubes of equal power rating or capabilities. (4) The use of a large, rugged, "oversize" filament. (5) The removal of grid and plate voltage limitations. (6) Heavy low loss grid and plate leads. (7) Extremely high interelectrode insulation without the use of undependable internal insulators.

RUGGEDNESS

The paramount thought in EIMAC design is ruggedness. EIMAC design and the use of Tantalum* has definitely eliminated such causes of tube failures as gas, stem punctures, insulator breakdown, etc. The large "oversize," conservatively rated thoriated tungsten filament assures the maximum of tube life and performance.

Be Sure Your Next Tube Has Tantalum Tube Life Assurance

*Tantalum grids and plates permit EIMAC to permanently guarantee against tube failures caused by gas released through accidental overload. Completely degassed Tantalum electrodes make unnecessary and undesirable the use of a chemical agency or "getter" to hold residual gases in chemical suspension on the walls of the glass bulb where any slight overheating would cause a permanent tube failure.

No Matter What Your Requirements, Remember
EIMAC Tubes Do a Better Job—Easier.

Now available in 75-watt, 150-watt, 300-watt, 500-watt plate dissipation ratings at all leading dealers.

EITEL-McCULLOUGH, INC. SAN BRUNO
CALIFORNIA, U. S. A.

● What is this stuff . . . DX, anyway? During the past month the three bands, 10, 20 and 40 meters, have seen plenty of action. As one ham puts it, "I never know what band I'm listening on, because the D X from day to day changes so much that I'll swear I'm on 20, and then I take a second look at my receiver only to find that I have been on 10." At this writing the fever seems to be at a high pitch on ten meters. From a reading of the reports it looks like the 28 MC band is going to be the one to use in making a short-time WAC . . . that is, if anyone is still in the mood for those things. Everyone likes to make records of one kind or another, such as quick WACs, multiple DX QSOs, Countries worked, etc., but I've got a new one for you DXers to shoot at. Now don't laugh. How about making WAC using one band for each Continent . . . six bands, six Continents. For example, looking at it from standpoint of a Pacific Coast ham . . . you might work North America on 5 meters, Europe on 10, Africa on 20, Asia on 40, South America on 80, and Oceania on 160. Of course, the operator's technique would come in mighty handy in figuring out just which band he could use to contact a certain continent. Hop to it fellows, and let's see how many can accomplish this Six-Band DAC. There may be someone who has worked 'em that way at the present time, and if so, let's hear about it. Remember . . . six bands, 5, 10, 20, 40, 80, and 160 . . . one continent on each band. (Maybe the Editor can be persuaded to offer, as a prize, his book . . . "Life Begins on 40!") ? ? ? ? ?

Quite a number of hams have sent in DX news and photos during the past month, and I want to thank every one of them for their co-operation. Among those who helped round out this month's DX news are: W2BJ, W6GRL, W6DOB, W6CXW, W9NTW, W6GRX, W8CRA, W6KRI, W3AYS, G6QX, W9DXX, W6CEM, W9OLC, W5QL, and W6HXU.

● ● ●
56 MC

● X1AY and W6DOB transmit and listen on 56 MC every Sunday between 1700 and 2100 GMT. X1AY is on 56.0 MC with RAC, and W6DOB is at 56.1 MC with T9X or ICWX. Here's a chance for some of you 5 meter bugs to get going with some experiments.

● ● ●
28 MC

● Ten meters is still plenty hot. Up to the present time, the following have made WAC on this band: D4ARR, G2YL, G5BY, J2HJ, W2DTB, W3FAR, W5QL, W6DOB, W6FQY, W6EWC, W6BAY, W6RH, W7AMX, W7FLU, W8CRA, X1AY and ZS1H. The first in the world for WAC was W3FAR and the first W was W3FAR. W6EWC on November 11th worked his sixth continent by snagging F8KJ. As far as I know, W6EWC, Wayne Cooper, is the first W6 to make WAC on ten. His other contacts were F8SCR, OA4J, VK7JB, J2LK and VE1EA. Lloyd Jones, W6DOB, worked VE4SH, LU1EP, VK3YP, J2HJ, F8CT and F8IHF for all continents. This was on November 15th. X1AY WAC November 16th. VK3YP needs South America. W6KIP needs Africa. W3AJY, who has worked 20 countries, lacks Asia for his WAC, also W1DZE is shy an Asian contact. Incidentally, the first W station worked by SU1SG was W1DZE. The other half of W6DOB, who is W6AET (XYL), needs Africa for her sixth. Nice going. VK3YP, W8CRA and W6DOB had three way QSOs lasting over an hour on October 29th and November 14th. I dunno . . . maybe this is some sort of a record.

W6ZH, Herb. Hoover, Jr., lacks only Europe for WAC on 28 MC Phone, which is really something. Think CXW needs one continent and W6JJU could use an African. Oh yes, W6QD needs North America, South America, Europe, Africa, Asia and Oceania, and I think old Bud Bane, W6WB, needs a transmitter. Speaking of Bud Bane, here's a secret . . . at least it was until now . . . you know, ud tells everyone that he is through with ham radio, and that he hasn't been on the air for months. Well, the laugh is on him. He has a nice dark cellar where he hides himself, picks out a dark, dark corner where he hooks up a 10 meter rig, and proceeds to pull nice fat sparks off of it with an oversized pencil. When he hears some ham approaching he turns everything off and says, "Naw, I've been outa ham radio for months." Wish he would put that thing on the air, instead of on a pencil.

This 10 meter band really seems to be the stuff now, and no foolin'. The fellows used to be on 20 and 40, but a listen on 40 nowadays and you don't hear any of the gang. They are all of 10 and 20. Every day there are more and more hams getting down on 10, and before long it will sound more like 14 MC . . . that is, in regard to the number of stations. There are many hams in other countries as well as in the U. S. A. who are doing mighty fine DX on this band. W5QL, Harold Hartman, not only is WAC but is piling up plenty of nice QSOs. LU1EP and LU9AX are both "going to town" and their signals are very consistent. ZU6P is on phone and worked W6ZH.

DX



By HERB. BECKER, W6QD

Readers are invited to send monthly contributions for publication in these columns direct to Mr. Becker, 1117 West 45th Street, Los Angeles, California.

Even old Fat Benning, W4CBY is on ten meters; guess he can't stand the public gaze any more. Poor old Fat! During the week of November 17th W8CRA made WAC 9 times. Not bad for a small-town guy. I never could figure how CRA got on the air so much during the day, so a couple of weeks ago while QSO with the fellow I asked him if he had a job, and what it was. He told me he worked in a pottery plant in his town, and stuck handles on tea-cups, and other pieces of pottery. Said if "Cannonsburg" was stamped on the cup, he put the handle on it. I investigated our tea-cups, immediately, and I found that all the handles on the "Caononsburg" tea cups had either dropped off or broken off. I think he better stick to brass-pounding . . . and while I think of it, if any of you fellows drink a cup of tea or coffee fro ma cup without a handle . . . just blame it on old Frank . . . it's alright with me.

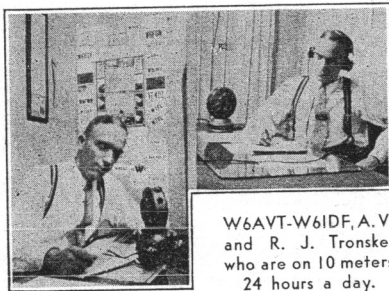

W6AVT-W6IDF, A.V. and R. J. Tronske, who are on 10 meters 24 hours a day.

14 MC

● This band still has quite a lot of nice DX on it, and from all reports there are many new stations breaking loose. W3AYS, Chas. Smack, Jr., says the following are coming through on 20: UE8NV a T8 sig on 14380 KC, UE3LE unsteady DC on 14375 WC, F8CRG chirpy DC 14350 KC, YM4ZO near DC 14370 KC, HB9T XTAL sig about 14400 KC, YN1AA Ztal sig around 14375 KC, CR7GC DC note anywhere between 14300 and 14400 KC.

W9OLC should get an orchid for working TA1C in Istanbul, Turkey. TA1C is DC and on 14005 KC. Can speak French but no English, and anyone who wants his QRA . . . write Bill Hanks, W9OLC.

VQ8AC is coming through every once in a while on 14250 WC. Look for him around 1500 GMT . . . and, yes, he has a chirpy DC sig.

CXW reports that CR7GC (exCR7AO) is coming through with his chirpy DC, along with plenty of ZS, ZU, ZT and ZE. Time . . . around 1500 to 1700 GMT. FB8C now signing FB8AB, is in there with his famous gurgle . . . 1530 GMT.

The grapevine method of getting gossip is still OK. This time we learn that G5YH has a new girl fren'. He claims she is REALLY R9. Whoa there, Chorley, take it easy. He's going to build a new rig with 200 smackers he made recently. Maybe I don't know, but if that YL has him well hooked, that 200 won't go into a rig, it'll probably go for a sparkler.

G2ZQ got his hands on an 852 somewhere, and via the "underground" radio system I hear that he and 5YH are going to set dear ol' Lunnon on fire.

Dave Evans, W4DZH, is fussing around on 14325 KC. Can't figure out what's wrong with that bunch in Atlanta. W2BJ works an LY and an LX for his 87th and 88th countries.

● ● ●
7 MC

● There is not as much activity on this band as there used to be, but it's not because the band has folded up, it's just that the fellows are not on it as much.

From the DX column of "73", edited by Bill Seitz, W6HXU, we get a choice piece of news . . . "W6CXW works a new one in CR8AA, located in Vasco de Gama, Portuguese India. CXW was his first North American contact, and made this CR8AA his sixth continent for WAC. Frequency 7135 KC T9 signal and came through at 1400 GMT."

W2BJ kicks in with some dope. Says that around 0500 GMT the following stations are putting through good signals on the East Coast: OH2NE 7156 KC T7, SM5UU 7040 T9, SP1IA T100 T7, SP1DT 7060 T9, FASBG 7110 T9, F8EG 7100 T8, ZUGAM 7120 T9, and ON4GU 7080 T9. A new one hooked by W2BJ is SV1B in Athens, Greece. Ray, who lives in Brooklyn, N. Y. is WAB (Worked All Burroughs), and he has prof. EA4AO is using P.P. 204-A's on 20 and 40, while on 10 he is only using an 852. Tough, isn't it?

Here's a laugh. During the recent VK Contest was listening to W6CEM. He hooks up with VK2YF and gives him his "Nr 921555". The VK comes back with, "Pse QRK?" CEM repeats his Nr, also giving the Aussie his report again. VK2YF pops back with, "Sorri OC, don't understand this new number system, pse QRK in old QSA es R system." Imagine a guy getting a report like 921555 . . . wotta sig, wotta sig.

W9NTW is using a Taylor tube in his rig, and is doing good work with 150 watts input. Hears HRIUZ and his buzz-saw signal, LA2X, OK5OA, and VP9XA . . . also wants to know where the heck the K7s are on 40.

Alice Bourke, W9DXX, received a letter from our good friend ZS2A, O. M. Reid . . . or just plain "Pye". Following is quoted from Pye's letter to W9DXX: "I'm off the air and don't expect to get back until about the middle of December. Have ordered a super Skyrider, and it arrives sometime next week if all goes well. I'm hoping nothing happens to it enroute. The other gear for the Xm is due to arrive during the first week in November. The proposed layout for the rig will be as follows: Final, one 50T, one 80Z buffer, and two 53's as doublers. As a matter of fact the last three tubes mentioned are incorporated in the 4 band exciter unit shown a little while back in QST. The input to the final will be in the region of 200 watts so I should be able to push a much better sig into the States than I have been doing with that poor lil 210 Hi. I'll be looking for you when I get on the air, and you might oblige by telling all the hams interested that I will be keeping a regular sked on 28 MC in hopes of a QSO."

We will all be glad to hear ZS2A back on the air, and a lot of the gang are wondering if he has settled down to a calm, domestic life with that very charming YL . . . or is it an XYL now?

This fellow Bob Haas, W8HWE, is really putting out a potent signal these days. He has been knocking 'em dead on 40 meters lately, and from the sound of his sig at my shack I would say that he is using all of 999.9986 watts. Bob must be a pretty fancy guy because he has his call printed in silver on a whole batch of safety matches . . . and when he goes to a hamfest he dishes 'em out. Not a bad idea, I guess, but better stick to DX, Bob.

I don't know who told me, but I heard that those two brass-pounders, W8KPB and W8DVS cleaned up a five gallon jar of cookies at the Beaver Valley Hamfest . . . somewhere in Penna.

Say Gang, don't forget, I'm still looking for all the DX news I can lay my hands on. If any of you fellows have a new antenna, either conventional or freak, send in the dope as I'm sure the rest of us would like to know about it . . . also, any exceptional DX worked is very much welcomed, and get together any items of personal interest that involve the DX boiled-cwls. That is always very choice news to the gang. Photos of DX stations should be clear-cut and, if possible, on glossy paper. Copy for January "RADIO" should be at my QRA not later than December 22nd. (Don't say anything, but the Editor in Chief has promised us as much space as we want . . . so hop to it.)

DX for most fellows has been pretty good, but for me it was just a headache. The other day I got all set for some good intensive brass pounding on 20. Had my ears glued to a weak, fluttery, fading signal . . . was holding my breath, because I was sure it was the 7th or 8th continent coming in at last. I sat and listened 25 minutes of straight CQs by this bird, and when he signed it was a . . . W . . . and was I burned up! (Think it was CRA on 10 meters.) Anyway, when I get my receiver back together I'll take another crack at it. Before the crash I hooked a brand new W9, so all was not lost. Well, Merry Xmas and have a Happy New Year for me too.

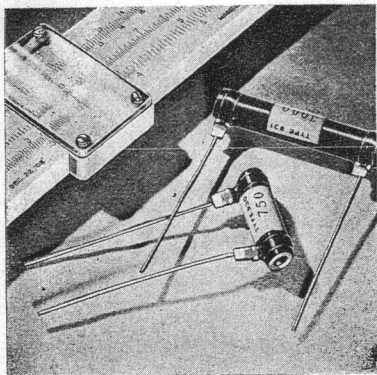

PYROHM Jr. RESISTORS



Genuine wire-wound vitreous-enamel resistors. Most compact. 5, 10, 15 and 20 watt ratings. All resistance values. For those crowded assemblies. You can install them . . . and forget resistor worries. They "stay put."

Crack-proof refractory tubing. Adequate heat dissipation. Quality resistance wire. wound under tension.

Wire ends brazed to lugs. Pigtailed soldered to terminal bands. Heavy vitreous-enamel coating. Permanent seal against moisture and damage.

And don't overlook AEROVOX SLIDE OHMS . . . convenient units that offer any resistance value within wide range, and lock for permanent fixed resistance after that. Available in wide range of wattages and resistance values. With removable mounting feet.

DATA New catalog just issued. Covers entire condenser and resistor line. Lists largest assortment of exact duplicate replacement condensers. Sample copy of Research Worker included.

AEROVOX

CORPORATION

84 Washington St.

Brooklyn, N. Y.

BIG 1936 WHOLESALE



CATALOG FREE

164 pages—Radio, Electrical and Refrigeration Equipment at lowest net prices. A catalog of great value to every dealer, service man and amateur. Complete sets, parts, amateur and commercial apparatus. Write today.

BURSTEIN-APPLEBEE CO.

1012-14 McGee St.

Kansas City, Mo.

RADIO CLUBS . . . Write for Special Group Rates for "RADIO"

10-Meter D-X Reports From W6AVT-W6IDF

All 28 MC reports except the stations marked Broadcast and Commercial which operate around 31.6 MC and 27,900 KC.

October 11, 1935
 W4XAM—12:20 PM, PST—R-9+—Broadcast.
 W9XEH—12:29 PM, PST—R-9+—Broadcast.
 W3FAR—12:30 PM, PST—R-7—CW.
 W5AC—12:31 PM, PST—R-8—Fone and CW.
 W4AUU—12:32 PM, PST—R-9—CW.

October 12, 1935
 W9LF—2:06 PM, PST—R-7—CW.
 W1DR—2:10 PM, PST—R-7—CW.
 W6GRY—2:11 PM, PST—R-8—CW.
 W1ZXE—2:12 PM, PST—R-9+—MCW.

October 13, 1935
 W9GBJ—3:30 PM, PST—R-8—CW.
 W9FJ—3:41 PM, PST—R-9—Fone.
 W9LD—3:42 PM, PST—R-9+—Fone.
 X1AY—3:45 PM, PST—R-7—CW.
 W5AFX—3:50 PM, PST—R-99+—CW.
 W8DYK—4:00 PM, PST—R-8—CW.
 W6IVU—4:02 PM, PST—R-8—CW.
 W9LF—4:15 PM, PST—R-6—CW.
 W6AWT—4:22 PM, PST—R-5—CW.
 W9ABE—4:30 PM, PST—R-5—CW.

October 19, 1935
 W9HJA—10:50 AM, PST—R-8—Fone 28 MC.
 W9HAQ—10:55 AM, PST—R-8—CW 28 MC.
 W9XCD—11:00 AM, PST—R-9—Broadcast.

October 20, 1935
 G5BY—10:30 AM, PST—R-7—CW 28 MC.
 W9NY—10:35 AM, PST—R-8—CW 28 MC.
 W6KIP—10:40 AM, PST—R-9+—CW 28 MC.
 W5WG—1:25 PM, PST—R-8—CW 28 MC.
 W9NY—1:27 PM, PST—R-99+—CW 28 MC.
 W9GBJ—1:30 PM, PST—R-8—CW 28 MC.

October 21, 1935
 W5WG—10:20 AM, PST—R-8—CW.
 W6DHZ—10:25 AM, PST—R-9—CW.
 W6BKV—10:28 AM, PST—R-9—CW.
 W7AVV—10:30 AM, PST—R-9+—Fone.
 W9GBJ—10:32 AM, PST—R-9—CW.
 W7AVV—10:35 AM, PST—R-8—Fone.
 ZS1H—10:37 AM, PST—R-6—CW.
 W2FDR—10:40 AM, PST—R-9+—Fone.
 W2TP—10:41 AM, PST—R-9+—Fone.

October 22, 1935
 W2TP—4:00 PM, PST—R-5—CW.
 W4LL—4:02 PM, PST—R-7—CW.

(October 23 to November 7 no report)
November 7, 1935
 W9MCD—10:10 AM, PST—R-7—Fone.
 W9ICO—10:20 AM, PST—R-8—CW.
 W4AJY—10:25 AM, PST—R-9+—CW.
 W4XI—10:53 AM, PST—R-9—Broadcast.
 X1AY—10:56 AM, PST—R-8—CW.
 W6ZH—11:10 AM, PST—R-99+—Fone.
 W9AGT—11:35 AM, PST—R-8—CW.

November 8, 1935
 W9LF—8:30 AM, PST—R-8—CW.
 ZS1H—8:32 AM, PST—R-5—CW.
 W9AGT—8:45 AM, PST—R-6—CW.
 W8MWL—9:00 AM, PST—R-9+—Fone.
 W6FDM—9:10 AM, PST—R-4—Fone.
 W1DZE—9:12 AM, PST—R-5—CW.
 W1AV—9:14 AM, PST—R-5—CW.
 W9SEC—9:20 AM, PST—R-7—CW.
 W9GFD—9:22 AM, PST—R-7—CW.
 W4CBY—9:40 AM, PST—R-8—CW.
 W6ZH—9:41 AM, PST—R-99+—Fone.
 W8EVV—10:05 AM, PST—R-7—CW.
 W9GFD—10:06 AM, PST—R-8—CW.
 W9AGO—10:18 AM, PST—R-7—Fone.
 W1FJN—10:25 AM, PST—R-8—CW.
 W2XIJ—12:30 PM, PST—R-9+—Broadcast.
 W5BXN—1:10 PM, PST—R-7—CW.
 W9ICO—1:12 PM, PST—R-5—CW.
 W9AGT—1:14 PM, PST—R-9—CW.
 W4AJY—1:25 PM, PST—R-9+—CW.

November 9, 1935
 G5BY—8:25 AM, PST—R-5-R-6—CW.
 W9NY—8:27 AM, PST—R-9—CW.
 W6JNR—8:30 AM, PST—R-3—CW.
 W9HAQ—8:35 AM, PST—R-9—CW.
 W6GRX—8:36 AM, PST—R-7—CW.
 W9AGT—8:44 AM, PST—R-5—CW.
 W8MWL—8:47 AM, PST—R-9+—Fone.
 W6ZH—9:00 AM, PST—R-99+—Fone.
 W9HAQ—9:03 AM, PST—R-9—CW.
 W4AUU—9:05 AM, PST—R-7—CW.
 W9LF—9:45 AM, PST—R-8—CW.
 W9EKU—9:55 AM, PST—R-9+—CW.

(Continued on page 31)

7000 Kc XTALS

New thick C&S cut high activity, single freq. response, guaranteed \$2.25 close to specified frequency. P-P

80M - 160M - C&S Cut - \$2.00 p.p.

C&S XTALS

836 E. WEBER AVE. STOCKTON, CALIF.

20

TRANSMITTER CIRCUITS

THIS VALUABLE REFERENCE BOOK

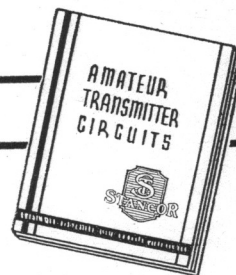

FREE!

COMPLETE design for 12 tested transmitter R-F section circuits and 8 modulator and speech amplifier circuits. Outputs ranging from the smallest to a big broadcaster.

Not only the circuit designs, but complete parts specifications. Listing transformers, inductances and all component parts. A complete handbook on transmitter design! This valuable reference book sent you free. Just tear out this advertisement and send with 12c in stamps to cover mailing expenses in order to get your free copy.

There is no further obligation. Hurry! The supply is limited.



STANDARD TRANSFORMER CORPORATION

856 Blackhawk Street, Dept. B
 Chicago, Illinois

Please send me the Standard Manual of Transmitter Circuits. I am enclosing 12c in stamps.

Name _____
 Address _____
 City _____ State _____

Aladdin Polyiron I. f. Transformers

Polyiron Core I. f. Transformers reduce QRM and improve any air-core superheterodyne.

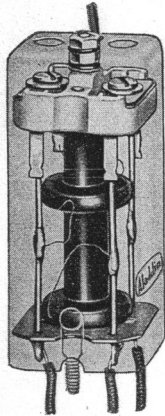

Type C

the largest air-core transformer used in communication receivers!

Polyiron is a patented magnetic core material molded from microscopic insulated particles of iron. The character of this material differs from ordinary iron in that eddy currents and hysteresis losses which occur in solid iron at high frequencies are not present in Polyiron.

The effect of this magnetic material in the core of an I. f. coil is to reduce the amount of wire necessary to secure a given inductance and to concentrate the magnetic field. This results in a high Q, a better L/R ratio, and lower distributed capacity. Thus the resonant peak becomes sharper and the selectivity greater with Polyiron core I. f. transformers than has ever been possible with air-core transformers. The Type C101M, illustrated above, is only 2 1/2" high and 1 1/2" square, yet equals in performance

Aladdin Polyiron Core Coils are used in the finest commercial receivers. The diagram (Electronics, May, 1934) shows the band-pass I. f. circuit of the All-Wave Stromberg Carlson Model 68 using Polyiron coils.

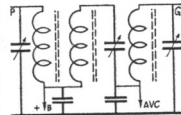

The most popular types of Aladdin Polyiron I. f. transformers are listed below. Where 6-volt tubes are specified, equivalent 2 1/2-volt tubes may be employed. All transformers are supplied with trimmer condensers of mica or air dielectric for both primary and secondary. Type C is in the small container. Type A is in the larger shield.

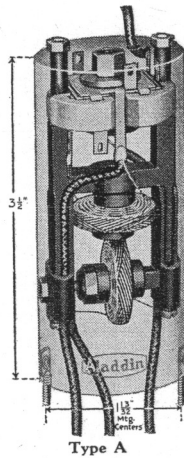

Type A

Specifications and List Prices

Mica Dielectric Trimmers

- Type A100, 456, or 465 Kc. Gain 250 between 6D6 and 6D6 tubes (illustrated above) (Specified for Jones 222, 20-40, Silver Super-Gainer, 4-tube Super-Gainer).....\$3.00
- Type A101, 456 or 465 Kc. Gain 62 between 6A7 and 6D6 tubes (for use with receivers which cannot handle the gain of the type A100 without oscillation).....\$3.00
- Type A200, 456 or 465 Kc. Gain 149 between 6D6 and 0.5 meg. diode load.....\$3.00
- Type A100C, 456 or 465 Kc. for 6D6 to a crystal filter (used in 20-40 and 4-tube Super-Gainer).....\$4.00
- Type C101M, 456 Kc. Gain 52 between 6A8 and 6K7 tubes, for mobile receivers.....\$2.50
- Type C200M, 456 Kc. Gain 58 1/2 between 6K7 and 0.5 meg. 6H6 diode load, for mobile receivers.....\$2.50
- With Air-Tuned Trimmers, size 4" x 1 1/2" x 1 1/2"
- Type G101, 456 or 465 Kc. Gain 75 between 6A7 and 6D6 tubes as first stage I. f.....\$5.50
- Type G201, 456 or 465 Kc. Gain 175 between 6D6 and 0.5 meg. diode load.....\$5.50
- Special for Silver "Radio"
- Type 5A assembly less trimmer and shield.....\$2.50
- Type 5B assembly less trimmer and shield.....\$2.50

All gain figures are approximate and depend on tube and circuit constants. List prices subject to 40% discount to amateurs.

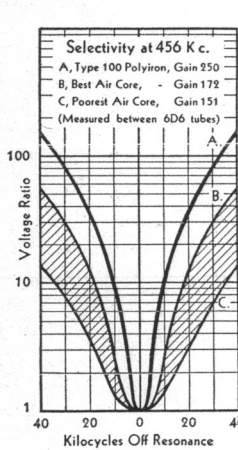

Small size Polyiron core I. f. transformers are particularly suitable for battery-operated mobile receivers which must be built in the smallest space, yet have high gain. Coupling of the coils may be varied in manufacture to secure flat-topping, sharp peaks, or maximum gain without sacrificing any of the advantages of high Q or the wide tuning range made possible with Polyiron. A typical example of comparative performance of air-core and Polyiron-core transformers is illustrated in the graph. Curve A is that of a Polyiron transformer compared with the best (B) and poorest (C) types of commercial air-core coils.

Amateurs, Experimenters, and "Ham" Distributors—Write for Full Information!

Aladdin Radio Industries, Inc.

466 West Superior Street

Licensee of Johnson Laboratories, Inc.

Chicago, Illinois

These devices manufactured under one or more of the following U. S. Letters Patents: 1887380, 1978599, 1982690, 1940228, 1978600, 1997453, 1978568, 1982689, 2005203, 2002500, 2018626. Other patents pending.

"Give the Ham a break"—

ORDER FROM W8DED

QSL CARDS (W8DED print—Stamp, samples)
CALLBOOKS (All U. S. & Foreign) \$1.25
HANDBOOKS 1936 ("Radio" or A.R.R.L.) \$1
LOG BOOKS (by A.R.R.L.) 40c ea., 3 for \$1
BLILEY CRYSTALS (BC3 \$3.95; LD-2 \$4.80)
EIMAC TUBES—LIFETIME MIKES—TRIPLETT
"RADIO" SUBSCRIPTION AT A BARGAIN!
WRITE US TODAY FOR SPECIAL OFFER!

Order Direct From

HAM PRINT SHOP—W8DED

"Rus" Sakkers, Opr.

53 E. 7th ST., HOLLAND, MICHIGAN

A Complete Engineering Service FOR THE AMATEUR

★ Transmitters and Receivers Designed and Built to Fit Your Own Requirements.

• Highest Quality Parts and Workmanship Throughout
REASONABLE PRICES

STEVENS RADIO CO.

934 Virginia Street Berkeley, Calif.

FORMS CLOSE ON THE 10th OF MONTH

RATES 10¢ PER WORD PAYABLE IN ADVANCE

CLASSIFIED
RADIOADS

FOR SALE—RK28 band-switching phone-CW transmitter as described by Frank C. Jones in this issue. Complete with all tubes and coils for all bands specified in the editorial article. Crystals and microphone not included. Built by Jones, and to be sold because it has served its purpose for the editorial pages of the magazine. Price, \$175.00, FOB. Frank C. Jones, 2037 Duarant Avenue, Berkeley, California.

7000 KC AT crystals guaranteed within 10 KC \$3.00. Sonneborn's Crystal Laboratory, LaPorte, Indiana.

LATHE-METAL TURNING. Six-inch swing, power feed. Necessity in every shack. \$11.95 at factory, Wt. 40 lbs. W6ELA, 105 East Avenue 38, Los Angeles.

QSL CARDS

Stamp for Samples

W8DDS PRINT

2156 W. 80th St.

Cleveland

STATEMENT OF OWNERSHIP, MANAGEMENT, CIRCULATION, ETC., REQUIRED BY THE ACT OF CONGRESS OF AUGUST 24, 1912.

"RADIO" published monthly at San Francisco, Calif., for October 1, 1935
State of California,
County of San Francisco

ss. Before me, a Notary Public in and for the State and County aforesaid, personally appeared H. W. Dickow, who, having been duly sworn according to law, deposes and says that he is the Business Manager of "RADIO" and that the following is, to the best of his knowledge and belief, a true statement of the ownership, management, etc., of the aforesaid publication for the date shown in the above caption, required by the Act of August 24, 1912, embodied in Sec. 411, Postal Laws and Regulations, to wit:

1. That the names and addresses of the Publisher, Editor, Managing Editor, and Business Managers are:
Publisher—Pacific Radio Publishing Co., Pacific Bldg., San Francisco, Calif.; Editor—H. W. Dickow, Pacific Bldg., San Francisco, Calif.; Managing Editor—None; Business Manager—H. W. Dickow, Pacific Bldg., San Francisco, Calif.

2. That the owner is:
Pacific Radio Publishing Co., Pacific Bldg., San Francisco, Calif.; H. W. Dickow, Pacific Bldg., San Francisco, Calif.

3. That the known bondholders, mortgagees, and other security holders owning or holding 1 per cent or more of total amount of bonds, mortgages, or other securities are:
None.

4. That the two paragraphs next above, giving the names of the owners, stockholders, and security holders, if any, contain not only the list of stockholders and security holders as they appear upon the books of the company, but also, in cases where the stockholder or security holder appears upon the books of the company as trustee or in any other fiduciary relation, the name of the person or corporation for whom such trustee is acting is given; also that the said two paragraphs contain statements embracing affiant's full knowledge and belief as to the circumstances and conditions under which stockholders and security holders who do not appear upon the books of the company as trustees, hold stock and securities in a capacity other than that of a bona fide owner; and this affiant has no reason to believe that any other person, association, or corporation has any interest, direct or indirect, in the said stock, bonds, or other securities than as so stated by him.

H. W. DICKOW,
Business Manager.

Sworn to and subscribed before me this 2nd day of October, 1935.

(Seal)

JOHN L. MURPHY.

Notary Public in and for the City and County of San Francisco, State of California. My commission expires May 20, 1937.

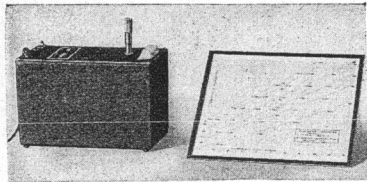

THE MICROMETER FREQUENCY METER has proved its accuracy and reliability for over two years in many applications. It still remains the outstanding value in amateur frequency meters. The specifications include full a.c. operation, automatic temperature correction, and a nominal accuracy of .02%. Complete with tubes and calibration, ready to use, \$54.00 net.

LAMPKIN LABORATORIES, Bradenton, Fla.

Sh! — Silence!

That's what some members of the family would like to tell you, but out of consideration for your enthusiasm they hold back.

CANNON BALL HEADSETS

You will get clearer reception of all foreign programs and you will not disturb the rest of the family.

Made by America's oldest manufacturer of headsets

Heavy bar magnets, double pole, aluminum cases, D. C. resistances of 2000, 3000 and 5000 ohms.

Sturdy construction, sensitive and faithful in reproduction.

Sold everywhere in America

C. F. CANNON CO.
SPRINGWATER, N. Y.



new! KELLOGG TRANSCIVER HANDSET

A better all-around Transceiver Handset! Highly efficient single-button Kellogg microphone, super-sensitive Kellogg receiver. Easy to hold. Fits the face. ● Microphone has greater sensitivity and "fatter" response curve than the usual "mike" of this type. Precision built, as are all Kellogg products. Gold plated diaphragm. Especially processed carbon.

● Receiver is the product of 35 years experience building telephone apparatus. Bi-polar magnet of cobalt steel. Cadmium plated diaphragm. Small, compact, easy on the ear. ● Simply and ruggedly constructed and light weight. Cast aluminum triangular handle. Baked black enamel finish.

Has 6-foot, 4-conductor, 18-strand tinsel cord of telephone quality. ● You will be proud to own this unit. Better yet, it's not expensive. Code No. 38-A, 70 ohm receiver, list price \$10.00. Code No. 38-B, 2000 ohm receiver, list price \$11.

KELLOGG SWITCHBOARD & SUPPLY CO.
1070 W. Adams St. CHICAGO, ILLINOIS

TRADE IN YOUR RECEIVER.

- HAMMARLUNDS-NATIONALS-RME9D.
 - MCMURDO-SILVER-PATTERSON, ETC.
- RECEIVERS SHIPPED PREPAID-NO EXTRA CHARGE TO WEST COAST.

SCHWARZ RADIO SERVICE
15 LAWRENCE AVE. DUMONT, N. J.

10-Meter D-X Reports

(Continued from page 29)

W9GFD—10:05 AM, PST—R-8—CW.
W4EF—10:15 AM, PST—R-9—CW.
W4XEM—10:16 AM, PST—R-9—Broadcast.
W8CRA—10:17 AM, PST—R-9+—CW.
W4CBY—10:18 AM, PST—R-9+—CW.
W9BVT—10:20 AM, PST—R-9—CW.
W9GFD—10:25 AM, PST—R-8—CW.
W9AGO—10:28 AM, PST—R-8—Fone.
W9MCD—10:35 AM, PST—R-9—Fone.
X1AY—10:50 AM, PST—R-9—CW.
W8MWL—11:15 AM, PST—R-7—Fone.
W9FQD—11:17 AM, PST—R-8—Fone.
W9DLL—11:21 AM, PST—R-9+—Fone.
W9GFD—1:50 PM, PST—R-8—CW.
W9BHT—1:54 PM, PST—R-8—Fone.
W6EWC—1:56 PM, PST—R-3—CW.
W9MCD—1:57 PM, PST—R-5—Fone.
W9ATB—1:59 PM, PST—R-9—CW.
November 10, 1935
W9KEA—Noon, PST—R-9—Fone.
W5ACL—1:25 PM, PST—R-8—Fone.

Brick-Bats From Readers

(Continued from page 20)

has no earthly reason for joining an Amateur league, he's down on the hame because they QRM his BCL set. Be that as it may, just tell him to send his money to ARRL. What does he get? He gets a MEMBERSHIP IN AN AMATEUR'S LEAGUE AND A SUBSCRIPTION TO AN AMATEUR'S MAGAZINE, doesn't he? He gets a certificate to hang on his wall. Even to this day, the practice continues . . . Warner does not get the commissions, but the non-ham gets a MEMBERSHIP TICKET in an Amateur's league. It's perfectly OK to give him the subscription to QST . . . we've no complaint to make on that score. But why give a MEMBERSHIP certificate in an Amateur's league? SEPARATE THE TWO . . . let a subscriber be a subscriber . . . LET A HAM BE A HAM! Years ago, Warner fixed it so that every subscriber to QST became a MEMBER of the league. The more subscriber-members he got, the more commission money he made. A complete editorial article, tell how this arrangement worked out for the "business" side of the league, will be told in a forthcoming issue.

In another part of your letter you tell us that if we don't watch our step we will soon have what we have taken away from us. I suppose you meant to say, "We will have everything taken from us". That's right . . . that's what "RADIO" is afraid of. That's why we are trying to instill the spirit of FIGHT into the Amateurs, so they will take charge of their own league, put better men in control of it, make certain that we won't have anything more taken from us. I see nothing wrong in that. If we fight the anti-Amateur interests like they have been fighting us, and if we give them a taste of their own medicine by exerting our entire efforts to stop this gam of "crush-the-ham", we will be looked upon with more respect when the next Conference comes to order.

In closing, you want to know if we are jealous of Warner's salary. Not at all, OM . . . if we had more ham privileges today than we had before Warner came, we'd be the first to suggest that his salary be doubled.

More Distance—Less Noise



**MILLER
PRE-SELECTOR**

J. W. MILLER COMPANY
5917 So Main St. • Los Angeles, Calif.

AMAZING RESULTS WITH LIGHT CELLS IN TESTED CIRCUITS

Easily Assembled

Pese Photo-Cells, \$1.50

Shipping Wt. 2 lbs.

- Construct the "INVISIBLE WATCHMAN" with the Pese SUPERSENSITIVE RELAY and safeguard your BABY JEWELS, VALUABLE PAPERS, Pese Supersensitive RELAY, \$3.00. Shipping Wt., 2 lbs.

Valuable practical, useful information with each order. Send for circular A.

PESE SCIENTIFIC PRODUCTS
4918 - 13th Avenue Brooklyn, N. Y.

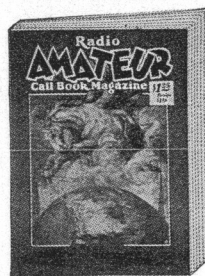

Radio Amateur Call Book

The only radio callbook published that lists all radio amateur stations throughout the entire World.

Also a complete list of high frequency commercial stations, International abbreviations and amateur prefixes, "Q, R, & T," systems for reporting signals, new US inspection districts and high frequency time, press and weather schedules.

Each copy contains a double post card addressed to the CALLBOOK for use in reporting your new QRA. We are extremely anxious to publish a callbook that will be 100% correct and want you to help us by checking your QRA at once in the latest edition and advise us of any errors.

PUBLISHED QUARTERLY MARCH, JUNE, SEPTEMBER AND DECEMBER

Single Copies \$1.25

Annual Subscription USA, \$4.00

Order your copy today from your local radio jobber or direct from:

Radio Amateur Call Book, Inc.
600 South Dearborn St. Chicago, Ill.

Hi-Power for Sound Equipment



The Carter Genemotor supplies the most Reliable and Economical "B" power for Class A or B Amplifiers from a 6 or 12 volt battery. Output up to 500 volts. Sturdy — Compact — Quiet in operation — Requires no oiling — Guaranteed. Write for Bulletin showing complete line of Genemotors for every purpose or specify your requirements.

CARTER MOTOR CO.

365 W. Superior St.

Chicago

DURABLE AS A BATTLESHIP



Radio's most important resistor development! Insulated against shorting—humidity—opens—breakage. Famous Metallized resistance principle. See them at your jobbers. Write for catalog.

INTERNATIONAL RESISTANCE CO.
Toronto, Canada Philadelphia, Pa.

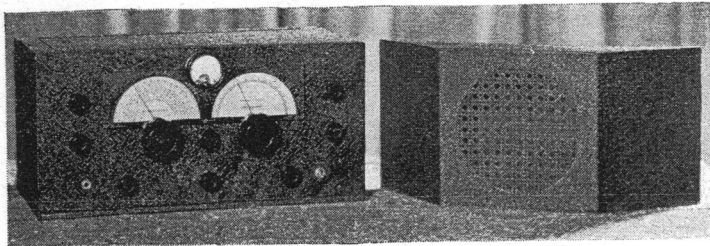

● In the engineering design of the RME-69 Single Signal Receiver so many detailed features have been incorporated that radio amateurs are already using it as a standard of comparison.

The new tuning mechanism is one of these outstanding features. The controls operate with the ease of ball-bearing rollers. Hours of operation do not cause finger fatigue.

Ample space is provided for the six tuning bands

on five-inch diameter scales. Even on ten meters the band-spread provided is sufficient to make tuning easy using the series crystal filter.

It has been our policy to let the RME Receiver speak for itself. After all, there is no better booster than a satisfied customer.

We have a folder giving all the details of this instrument. A copy will be forwarded for the asking.

RADIO MFG. ENGINEERS, INC. 306 FIRST AVENUE PEORIA, ILLINOIS



No. 284 Knob



No. 262 Dial Plate



No. 316 Micromaster



No. 389 Airplane Dial

CROWE Radio Components Make Most Welcome Gifts

For Your "Ham" Friends

Here Are Some Suggestions:

A new set of CROWE dial plates with matched knobs to dress up the transmitter.

A CROWE Micromaster dial for easy shortwave tuning and accurate logging.

A large two-speed airplane dial to add professional appearance to any receiver.

CROWE PARTS are carried in stock by leading Jobbers and Dealers all over the country. They're easy to buy and are sure to be useful. "Crowe perfection means genuine satisfaction."

Bulletin 75 showing a new line of products will be ready soon. Write or ask for it.

Representatives in Principle Over Seas Markets
CROWE NAME PLATE AND MANUFACTURING CO.
1755 Grace Street Cable Address: Crowname-Chicago CHICAGO

LITTELFUSES

Radio men can use Littelfuse Products profitably in their work. New test instrument—pocket size—TATTELLITE—cost only \$1.00. Also Littelfuses for instruments; Hi-Volt Fuses for transmitters, etc. Neon Voltage Fuses and Indicators. Aircraft, auto, radio Littelfuses—mountings. Write for catalog.

LITTELFUSE LABORATORIES
4236 Lincoln Avenue Chicago, Ill.

ENGRAVING

Instrument Panels Exclusively Since 1925
Bakelite Nameplates. List on request.

A. L. WOODY
189 W. Madison St. Chicago, Ill.

Side-Lights on the McElroy Code Championship Tournament

Statement by R. F. Trop, code instructor and treasurer of the Massachusetts Radio and Telegraph School, Inc., 18 Boylston street, Boston, Mass., with reference to the professional code speed copy test held at the Brockton fair grounds, September 14, 1935.

● Many undoubtedly marvel at the ability of the contestants to copy Continental code at the terrific speed of 69 words per minute with practically a perfect copy.

I trust you all recognize that this attained speed would not be possible unless the contestant is an expert typist on the mill. Five professional code copy experts competed and all express their opinion that the test was conducted in the best manner of any they had ever attended.

Six judges were named as follows:

Charles Kolster—U. S. Radio Supervisor, First District.

Joe Toy—Internationally known newspaper writer and Editor of daily articles in the Boston "Herald-Traveler".

Lloyd Green—Lt., U.S.N.R., and Radio Editor of "Boston Globe".

These three named above acted as judges of copy submitted by the contestants and upon their decision the winner of the contest was declared.

Technical judges were as follows:

Mark MacAdams—Technician who arranged circuits. Officer of state police in charge of radio, and technical adviser of Ware Radio, Brockton, Mass.

J. F. Rigby—Code expert in charge of RCA Communications, Boston office.

R. F. Trop—Code instructor and authority on code transmission and reception of Massachusetts Radio and Telegraph School, Inc., 18 Boylston street, Boston, and Ex. Lt., U.S.N.R.—Assistant D.C.O., U.S.N.

Having been an instructor of code, both Morse and Continental for a period of over 15 years and an operator for more than 25 years continuous, I must confess that the speed at which the contestants can copy code on a mill was a revelation to me.

The copy submitted was checked and put through the Klienschmidt transmitter just a few minutes prior to the test in order that no contestant would be familiar with the copy before the test was run and I personally kept in my pocket the printed copy of which the tape was made until after the test was completed before it was submitted to the judges for check on material. I know positively no contestant was familiar with the text on the tape.

As all other tests in the past have been conducted using straight English sentences taken from normal newspaper print, we decided it would be only fair to use the same kind of material as this would give the contestants an opportunity to establish a maximum speed with the most certainty of perfect copy and also would make no change in the procedure from previous established records.

What was of most interest to me as a student of high speed code copy ability was that all contestants desired that the sound volume be much greater than ordinary signals received over radio and when the volume control was at its maximum signal strength, there was where they liked it best. However, most of the contestants wore the head phones partly ahead of their ears which reduces the volume of sound appreciably.

The hall was jammed with enthusiasts—fully 2000 people and mostly code readers were present and the external noise was fully

up to 25 db by the normal noise attendant such a gathering.

The first test was run at 48 words per minute. All got perfect copy. The second test at 54 words per minute. All got perfect copy. The third test at 60 words per minute and most all got perfect copy. The fourth and final test was run at 69 words per minute and several got good copy. Two got almost perfect copy.

Now let me explain—attached hereto is a transcription of the tape with pencil markings as it run through the transmitter at 60 words per minute which I made for just 60 seconds of time. The marks are on the tape as made at the time and the actual number of words that passed a given spot in a definite period of time are recorded.

Here are the words taken off between the pencil marks:

INJURED, (TEN THOUSAND SIX HUNDRED THIRTY FIVE BEING CHILDREN III NEARLY ONE THOUSAND PEOPLE WERE KILLED OUT-RIGHT AAA ONE HUNDRED EIGHTY BEING CHILDREN III THE TRAVELER BELIEVES THAT WITH THIS PERSONAL PLEDGE FORM OF CAMPAIGN IT CAN INCULCATE THE IDEA THAT DRIVING IS A PERSONAL MATTER MORE THOROUGHLY INTO THE CON- SCIOUSNESS ETC

Period is shown as "III" and comma as "AAA".

It will be noted that exactly 250 characters are included in the above text between the brackets which according to government count would be just 50 words per minute, five letters per word. Now if we count all the spaces between each word, the period and comma as one character and the space between the words and the comma and periods as a character, the same as between the words the count amounts to just 300 characters which would be exactly 60 words per minute machine count.

Apparently many of us have failed to take into consideration that there are two different ways to count words per minute. Actual number of words per minute which I designate as government count and actual run of tape which I designate as machine count. You will note if you check the above again that if you count the spaces between each word as a character and allow one space either at the beginning of the copy or at the end of the copy, you will count enough words to exactly make 60 words per minute.

Ted McElroy and Ben Chapman were the best of the contestants, each showing almost a perfect copy for two minutes. McElroy's copy had two mistakes and Chapman's had three mistakes. It is possible that either could have copied code at a faster speed and had a majority of the transcript correct—how much faster is problematical.

The speed was beyond my limit to determine good code and I am certain was beyond the limit of most of us to even read the tape and determine code characters.

What is the process by which this speed is accomplished has been asked me by several good code copy experts and my answer can only be a conjecture, however, I look upon the possessor of such a marvelous sense of hearing to determine English words from this speed, as one perfectly trained in another language to recognize words spoken in this language at a terrific rate of speed and exceptionally accomplished with the use of a mill who runs the typewriter automatically and records the transcript very much the same as a sensitive camera film would do under exposure to rapid changes of light intensity and the mind retains these impressions for sufficient period of time to enable the operator to make the record which is soon erased and forgotten.

FOR BETTER RADIO

Use

Hammarlund

I.F. TRANSFORMERS

AIR-TUNED • VARIABLE COUPLING

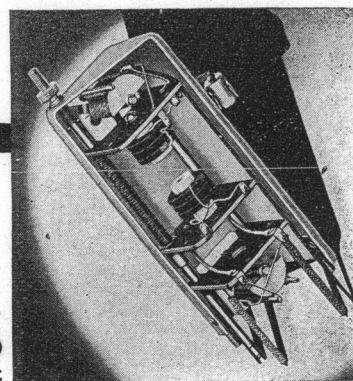

- 1 CONTINUOUS VARIATION OF BAND WIDTH — EXTREME SELECTIVITY TO HIGH FIDELITY
- 2 PANEL OR INDIVIDUAL CONTROL — POSITIVE COIL SPRING ACTION
- 3 IMPREGNATED THREE PIE LITZ COILS - ISOLANTITE CORES — HIGH GAIN
- 4 FOR ANY I.F. AMPLIFIER WITH SCREEN GRID TUBES — 175 AND 465 KC TYPES
- 5 ONLY 2" x 2" x 5"
- 6 GUARANTEED STABILITY

Get More Stations, Sharper Tuning and Louder Signals With These HAMMARLUND COILS



USERS say these low-priced Hammarlund Coils out-perform any others at any price. They are designed to give maximum signal strength and greatest selectivity on all bands.

"XP-53" the remarkable Hammarlund low-loss dielectric is one reason. Many other exclusive features, such as no artificial coloring to cause losses. Set of four 17-270 meter coils (4 or 6 prongs), \$3.00 and \$3.75 each list. One extra coil covers 250-560 meters. Coil forms (4, 5 or 6 prongs), 35c and 40c each list.

Write Dept. PR-12 for Complete Catalog

Hammarlund Manufacturing Co.
424-438 W. 33rd St., New York



TRIMM FEATHERWEIGHT

The Headset of Excellence

Lightest in weight—only 4½ ozs., complete 2 units, headband and moisture proof six-foot cord; operates satisfactorily under most trying conditions in either hot and humid or cold climates; best grade cobalt steel magnet, will retain magnetism indefinitely; exceedingly durable—made to withstand rough treatment.

Full information on request. Write Dept. R1
TRIMM RADIO MFG. CO.
1528 Armitage Avenue, Chicago, Ill., U. S. A.

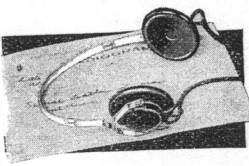

SANGAMO
Accurate
Condensers

A quality product for the amateur who wants the best results. Available in 1000, 2500, and 5000 volt construction.

Write for catalog sheet

SANGAMO ELECTRIC CO.
SPRINGFIELD, ILLINOIS

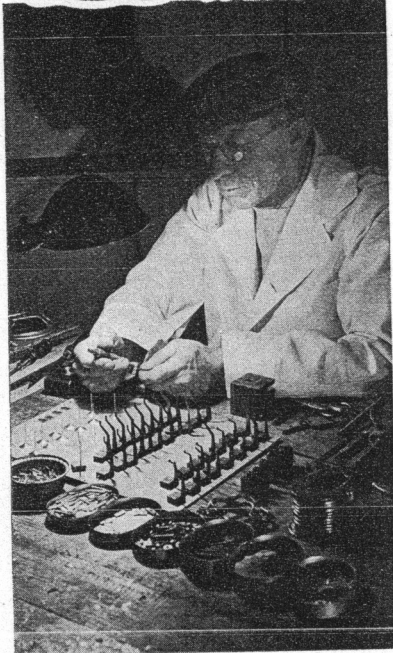

EVERY part in every single QUAM speaker is individually inspected like the parts in the finest custom built automobiles.

QUAM-NICHOLS CO.
 1674 Broadway New York
 1623 W. 74th Street, Chicago
 30 9th Street SAN FRANCISCO
 303 E. Pike Street Seattle
 209 W. 17th Street Los Angeles
 3037 Knox Avenue, S. Minneapolis, Minn.
 "AMERICA'S LARGEST SPEAKER MANUFACTURERS"

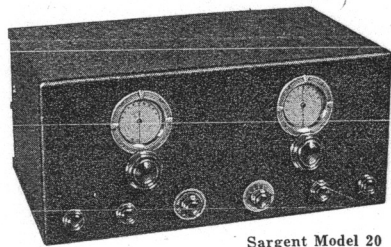

Sargent Model 20

- One Stage Pre-Selection
- A.V.C. and Manual Volume Control
- Continuous Band Spread, Calibrated for Amateur Bands
- Coil Switching—No Plug-in Coils
- Built-in, Hum-free Power Supply
- Headphone Jack
- Excellent Broadcast Band Reception
- Ideal for Shipboard Work
- Razor-edge Selectivity
- Fractional Microvolt Sensitivity
- Outperforms Receivers selling for 3 times its price.

Short Wave Fans! Amateurs! Here It Is!

Everything You Want in an All-Wave Communication Type Super

Everything you can possibly ask for in a communication type super-het, yet priced so you can afford to buy it. Model 20 is a well built receiver, carefully designed to amplify the weakest signals with an absolute minimum of interference and noise. Its "effective sensitivity" is extremely high, and it receives weak signals lost in the noise level on most sets.

Model 20 prices given below include an 8" Jensen speaker unit and a complete set of tubes. For speaker cabinet, finished to match receiver add \$3.25 net to these prices.

This will be the outstanding receiver of the 1936 season. ORDER YOURS TODAY.

AMATEUR NET PRICES

Model 20-SA, 15-550 Meters, complete.....\$59.50
 Model 20-MA, 15-1500 Meters, complete.....\$67.50

IMMEDIATE DELIVERY

E. M. SARGENT CO.

212 Ninth St., Dept. R Oakland, Calif.

\$1.00 Brings You the Next Four Issues of "RADIO"

New

STEATITE SOCKET

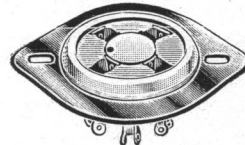

Genuine Alsimag-Steatite, the best ceramic for short-wave operations. The improved spring retainer ring for mounting to chassis provides resilience which prevents breakage in mounting or in use. The most electrically efficient contacts. No rivets used. This socket will definitely improve reception on wave lengths below 30 meters. See them at your local jobbers.

Coast Sales Representatives

MARSHANK SALES CO., INC.
 2022 W. 11th Street
 Los Angeles, California

JAMES P. HERMANS CO.
 235 Ninth Street
 San Francisco, California

DON H. BURCHAM
 917 S. W. Oak St.
 Portland, Oregon

AMERICAN PHENOLIC CORPORATION
 CHICAGO

HOW TO MAKE A HAM HAPPY

Send "RADIO" for 1 year to a brother ham. A Christmas Gift that keeps on giving for an entire year. Reminds the recipient of your thoughtfulness 12 times a year. What better gift can you give a friend in ham radio than a 1 year subscription to "RADIO"? We will send a Christmas card to him, telling him that the subscription comes as a gift from you. To cap the climax, we will do our share, too. The gift will cost you only \$2.00, saving you \$1.00. Send several subscriptions, if you so desire. Your own, if you wish to include it at the \$2.00 Christmas rate . . . or, if you are already a subscriber, you can extend your present subscription for a year and save \$1.00.

Send your orders to "RADIO", Pacific Bldg., San Francisco, Calif.

Name of person to whom "RADIO" is to be sent, with your compliments

His address.....

Name of person sending the order

Alice R. Bourke

(Continued from page 21)

for the postman on our route during the chain-letter era, when all the hams remembered Alice simultaneously. I think there are approximately 30,000 active hams in the country. As a conservative estimate, at least 27,500 of them were eager to see that Old Age didn't get me before I received my proper share of the nation's dime-crop.

Generosity is characteristic of all the ham gang. I certainly appreciated the thoughtfulness of a W6 whom I worked one hot night last summer. He was so earnest in his regret that I couldn't be with him so that he could blow me "to a couple of nice cold scuttles of suds."

While I do not drink, nevertheless it is nice to know that there is a standing invitation awaiting me in that west-coast shack "to hoist a few schooners" any time that I hit that town.

Relative to schedules, I keep few.

Up in Montreal lives VE2DG, who rates as Ham Number One for me. With his fine legible fist, shrewd wit; keen, comprehensive intelligence and sterling personality, a QSO with Doc Sheehan furnishes a highlight for the darkest day.

I have not had the pleasure of meeting Doc personally, but some day I want to have a nice long rag-chew with him, the XYL and their two daughters. It is a treat to look forward to.

Unfortunately, skeds with VE2DG do not jell very well, but when our sigs do cut through the QRM, how our keys do click along!

During the cold weather, I listen twice a week for VE4QB, up in Saskatchewan, and if luck is with us, the YL up there lets loose with her heavy artillery—the entire 10 watts—and we proceed to forget that time exists. Josie's transmitter is battery operated, and the battery is charged by a windmill. Her brother Leo is the second operator.

I have several one-sided transmission skeds at present. Quite a few German, and many English SWLs listen at particular periods for signals which they have asked me to send for tests.

Another one-sider is a daily sked with Charles Hamilton, who was my 600th QSO, and who is now chief operator on a large ship.

Until recently, a more or less regular sked was kept with the A1 operator at Parris Island, where the noble marines hang out. Great place, that island! In the evening, as dusk lowers, it is difficult to determine from the R9 buzzing, whether a squadron of naval planes is landing, or whether the homing native mosquitoes are coming back to pick out their favorite sea-going soldiers!

But alas, one of the mosquitoes punctured the hi-power tube of the island rig, and there is an enforced QRT on the sked, until replacements arrive.

A friendship which I prize highly has developed from a sked with W4CBA. We had the pleasure of welcoming this likable ham and his lovable XYL at our shack during the Century of Progress.

This spring the OM and I stopped overnight at Chattanooga, and W4CBA took us on a tour through hamdom of that most hospitable city.

The bright spot of a memorable evening was a visit to the home of that prince of good operators, W4PL of Shepherd, Tennessee, whose beautiful fist and impeccable operating technique are marks for all ambitious hams to shoot at.

Ham radio seems to have universal appeal, the potency of which is attested by the great number of commercial operators, busy with radio during working hours, who

(Continued on page 36)

ORDER NOW and AVOID DISAPPOINTMENT!

Only through a fortunate purchase have we been able to offer you these tubes for the past few months—at this ridiculously low price. We doubt that the Amateur will ever again have the opportunity to purchase a \$17.50 tube at anywhere near this price! Remember—we will stand behind every tube we sell! Do not hesitate to purchase . . . GENUINE.

Western Electric

\$4⁹⁰ 211-D

FIFTY WATER TRANSMITTER TUBES

BRAND NEW! FULLY GUARANTEED!!

Standard fifty watter base (regular price \$17.50). Standard characteristics (interchangeable with type 211 and 211-A). Has new long-life filament. Rated RF output as an amplifier—100 WATTS!

Every tube in its original Western Electric carton! The Western Electric name is your guarantee of highest quality. Your money cheerfully refunded if you do not agree with us that this is the greatest value ever offered to the amateurs! Every tube is unconditionally guaranteed for 30 days. (Broken glass and burned out filament the only exception.)

● Come and see our New Large Salesroom. Complete stock carried of all standard lines. All well known Ham receivers on demonstration.

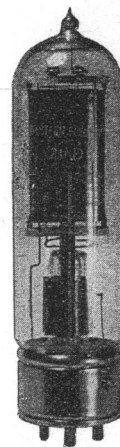

HARRISON RADIO CO. 12 WEST BROADWAY
Dept. PR12, New York City

★ FORCED TO LARGER QUARTERS ★ NOTE OUR NEW ADDRESS ★

LET'S GET TOGETHER

Your inquiry about any apparatus will prove to you that it is to your advantage to buy from me.

I give you specialized personal service of genuine value that is not available from other jobbers.

I take in trade apparatus you do not need on apparatus you do need. So I have used apparatus at big savings, too.

I stock at lowest prices: RCA, Eimac, Taylor, United transmitting tubes. National, Hammarlund, Thordarson, Cardwell, Cornell-Dubilier, Dwyer, Johnson, Astatic, Turner, Shure, Brush, Ohmite, Trimm, Triplett, Barr, Peak, Bliley, Mac-Keys, other parts.

IN STOCK—IMMEDIATE DELIVERY

The new RME-69s.....	\$118.80
PR-16s (at last) prepaid.....	95.70
National HROs	167.70
Breting 12s complete prepaid.....	93.00
Silver 5Ds complete prepaid.....	109.80
Super-Sevens complete prepaid.....	49.50
The new Super Skyriders complete prepaid.....	79.50
RCA ACR-136s complete.....	69.50
Super Pros complete.....	194.04
Collins and RCA transmitters	

Trade in Your Receiver or Transmitter

Every inquiry and order is personally attended to by Robert Henry, W9ARA; an active amateur for eleven years; graduate E.E. from M. I. T.; and owner of Henry Radio Shop selling amateur apparatus for seven years. Write for any information.

HENRY RADIO SHOP

211-215 NORTH MAIN STREET

BUTLER, MISSOURI

\$1.00 Brings You the Next Four Issues of "RADIO"

Alice R. Bourke

(Continued from page 35)

troop home to their ham shacks to pound brass for pleasure. Many the FB QSO I have had with such "commies" as W5BNO, W6ARD, W6KLU, W7BHE, et al.

A week or so ago, I achieved one of my life ambitions—I worked VP5PZ! I had one of his QSLs in my shack, and I wanted to work his station so that I would have a legitimate right to have the card on my wall.

Honestly, this typewriter would require a bushel or so of zeros to express how many times I have called the elusive gentleman in Kingston. Instead of saying "hello" when they meet me most of my ham friends have taunted me with: "Well, did you work VP5PZ yet?"

The maddening feature of my vain signal pursuit has been that rain or shine, VP5PZ rolls into my shack R9, every day of the year!

Well, I got him, and to my boundless surprise, our FB QSO was the result of being called by him!

Now I want to hook my South African correspondent, ZS2A, down in Uitenhage, so that we may QSO by air, and everything will be hunky-dory.

Well, by this time, the boys and gals probably will start yawning, so it is time to QRT and get back to 14286 KC, which is my favorite parking place.

A year ago, RADIO honored me by publishing a story about my station, and the correspondence from all over the world which has flowed to my QRA, makes me believe that the circulation of RADIO must be at least double that of the Saturday Evening Post.

Consequently, I am taking this occasion to hope that this Christmas will be a merry one for all the ham gang. I hope the New Year will bring each one of them happiness, prosperity, and oodles of DX.

The Christmas sentiment reminds me of a hearty laugh which I enjoyed last year.

My Christmas cards bore an exterior view of my home, and read: "Greetings from W9DXX." My QRA followed.

A few mornings after the new year, a gentle feminine voice called me on the fone, and while no names were mentioned, I was informed that the lady was the wife of a cop-friend of mine. She had never heard of W9DXX, and quite evidently, was equally unfamiliar with Ham Radio, because she thought my call letters represented the name of the gambling joint where her erring pardner dropped the monthly payroll check, and to her, my be-ootiful antenna system represented the wires over which the not-too-sure-shot tips on the ponies came in. Hi!

Phone-CW Xmtr

(Continued from page 17)

The standoff carrying the two .004 mfd. porcelain plate blocking condensers in series, must be centered in the oversize shield partition hole, or 500 RF (not DC) watts will arc right through it to ground:

Operation requires only reasonable care, no power amplifier neutralization, an 0-100 or 0-200 milliammeter for the exciter, an 0-500 milliammeter for the final amplifier, and a couple of suitable light bulbs of 50 to 300 watts for RF output check, a Neon bulb for interstage exciter check, and maybe an 0-25 milliammeter, if one is very flush, for grid current check.

There is no neutralizing except the buffer neutralizing-regeneration condenser, and the whole tuning operation, with coil and parts specifications followed, is so simple that the old-timer will laugh when he's through tuning up—in a couple of minutes, not in a couple of hours, as in the past.

Boys... HOW IT'S CLICKING!

THE NEW "5D" SUPERHET HITS THE BULLSEYE WITH AMATEURS!

Here's the 10-tube High Frequency Receiver that has been making such a hit with amateurs all over the country... listen to the W.A.C. Boys sing its praises over the air... and read what Engineer Grover (WPDD and W9FJ) says about its perfect performance.

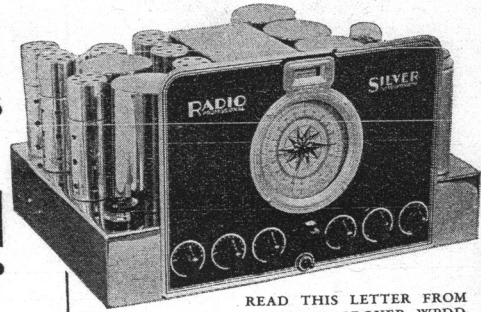

READ THIS LETTER FROM ENGINEER GROVER, WPDD

"Perhaps you would be interested in knowing the results I have obtained to date. All contacts, with very few exceptions, have been 100%... all on phone on the 20 meter band... South America, Cuba, Haiti, West Indies, Mexico, Canada, East, West and South coasts of the U. S. have been made within the past three days.

"The permanent logging band spread works perfectly, and makes schedules easier. The parallel crystal works perfectly in cutting QRM, and background noise level is negligible. Have tried receiver on all bands and find it works perfectly, and with more than enough volume on all stations. Foreign broadcast stations come through effortless, with beautiful quality. I notice absolutely no image (repeat spots) which is certainly great, after the performance of my former receiver.

"Congratulations on the perfect engineering design, beautiful appearance and marvelous performance."

Charles F. Grover (W9FJ) Engineer,
WPDD, Police Department, Chicago.

With more valuable features than any other communication receiver at anywhere near its price, it brings you:

Ten tubes with twelve tube functions... Two tuned R.F. stages on all four bands... Low C tuned circuits, all air trimmed and tuned... Band spread tuning... Crystal filter... All A.C. operated, one unit, no hum... Sensitivity better than 1 microvolt... Variable selectivity, 150 cycle to 10 kc... Amplified automatic volume control... Polished chromium welded chassis... 3-inch Jensen concert speaker, and phone jack... Covers all five amateur and all s.w. broadcast bands.
Available from your jobber, laboratory assembled and tested, RCA and Hazeltine licensed, complete for \$109.80 net to amateurs.

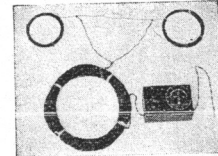

Jones - Silver "Super Gainer" Clicking, Too!

The three tube Super Gainer with double R.F. and I.F. regeneration gives results almost equalling those of expensive factory built superhets.

Its sensitivity is unlimited, exceeding even that of the highest priced receivers. Its selectivity is controllable—anything up to practically single signal. The circuit uses a 6C6 regenerative first detector, 76 H.F. oscillator and 79 as regenerative second detector and audio stage with Aladdin iron core I.F. transformer.

The mechanical assembly is of the most advanced communication type, with all parts arranged for the shortest direct leads for wiring. It will immediately give results no other set at its price can touch.

Price, wired and tested, with coils for 80 meter amateur and 49 meter broadcast, \$23.40 net.

Add for four additional pairs of coils for 10, 20, 40 and 160 meter amateur and all short wave broadcast bands, \$4.50 net.

Add for A.C. or D.C. operation, \$4.50 net.

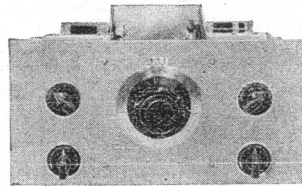

Ellis (W5ETC) Tests "Super Gainer" and Here's What He Says:

I received the A.C.-D.C. "Super Gainer" and after a careful test I am more than pleased with its performance. I find:

● Sensitivity enough to get right down to the noise level. The Super Gainer brings in all kinds of DX.

● Wonderful frequency stability. It will hold for hours without change of beat-note the c.w. signal from a good crystal-controlled transmitter.

● Low noise level. Less than half the inherent noise level of the eight tube super the "Super Gainer" replaces in my station. Low hiss.

● Lots of volume for headphone reception. The volume control must be turned way down on most signals.

● A hum-level so low as to be entirely unnoticeable.

● A very satisfactory single-signal effect.

In performance it can be compared only with the very high-priced superheterodynes using crystal filter. I am mighty glad I bought this set.

Bob Ellis, W5ETC,
Tulsa, Oklahoma.

Double Your Short Wave Reception With R9+ Tuned Antenna!

In practical tests the new R9+ Tuned Antenna has increased short wave signal volume on weak signals by from three to six times over present antenna equipment. It will give your reception a tonic equal to one to two stages of radio frequency amplification ahead of your receiver, tremendously reduce noise, and increase selectivity. Representing, as it does, years of research on antenna problems—and beginning where all other antennae leave off—its cost of \$8.85 net, fully assembled, soldered and ready to put up in half an hour, will prove to be the greatest and most beneficial value you have ever obtained for your radio dollars.

McMurdo Silver Corporation 3362 N. Paulina Street, Chicago, Illinois

Enclosed 10c for 32-page Manual of Design, Construction and Operation of 5D Superhet.

Send free circulars on 5D Superhet, the "Super Gainer," also R9+ Antenna.

Name

Address

City..... State.....

12-RM

McMURDO SILVER
CORPORATION Division of
G.P.H., Inc.
3362 N. Paulina St. Chicago, U. S. A.

AMATEUR HI-LIGHTS from Allied Radio

NOW—"It's Beyond the Blue Horizon"

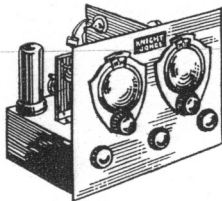

THE NEW JONES ULTRA S.W. RECEIVER

A new Frank Jones all-purpose receiver noted for exceptional sensitivity on the ultra-short wave bands from 2½ to 10 meters. Uses two Acorn tubes, a 6C5 and a 6F6. Utilizes full sensitivity provided by a super-regenerative detector plus a regenerative R.F. stage, without background hiss. Can be used either as permanent station A.C. receiver or can be adapted for mobile use, using batteries for power. Can be assembled and wired by even the least experienced Amateur. Write for our Free Parts List quoting attractive prices for building this new Jones Ultra-S.W. receiver.

HERE'S PEP AND POWER AT A PRICE

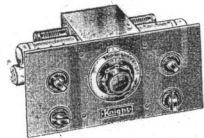

THE KNIGHT-JONES "SUPER-GAINER"

Frank Jones designed it. It's hot! A real communication receiver at a price never before matched in Amateur history. Available completely wired, or if you like to "roll your own," available in a kit of matched parts. By the use of regeneration at two frequencies, three tubes do the work of six. Other features are: real Bandspread tuning; iron-core variable coupling I.F. transformers; real selectivity and sensitivity for both C.W. and phone work; regenerative 1st and 2nd detectors; electron-coupled high frequency oscillator, etc. Available in battery or AC-DC models. Send the coupon for FREE complete data.

YOU CAN ADD WATTS AND WATTS

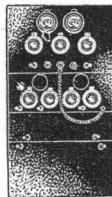

NEW PROGRESSIVE TRANSMITTER KITS

Whether you want 25 watts, 50 watts, 150, 250 or 500 r.f. watts, C.W. or phone, the new Silver progressive transmitters designed around the Jones harmonic exciter are the berries to build—or to rebuild your present rig up into—for nothing is wasted as power is increased. The illustration shows 500 watts of r.f. with exciter, modulator and power supplies in a 36" rack, yet not a bit crowded. You can build 50 watts of it for less than \$60.00, including modulator and power supply, or the whole 500 watts for under \$200.00. Data is yours for the coupon.

Allied Radio
CORPORATION

**FOR MORE HI-LIGHTS
SEE YOUR ALLIED CATALOG**

ALLIED RADIO CORP.
833 W. Jackson Blvd.
Chicago, Ill. Dept. J.

- Send me your FREE 1936 Catalog.
Send me the following:
 Free Parts List for Jones Ultra-S.W. Set.
 Free Circular on the Super-Gainer.
 Free Circular on Jones-Silver Transmitters.

Name.....

Address.....

City.....State.....



Increase the Fidelity Range of Your Receiver or Amplifier By Using the VARITONE*

THE VARITONE AUDIO UNIT IS THE ONLY TRANSFORMER OF ITS KIND GIVING CONTINUOUSLY VARIABLE LOW END, HIGH END, OR LOW AND HIGH END EQUALIZATION.

DOES YOUR AMPLIFIER OR SET SOUND

TINNY LIKE THIS?

OR DULL LIKE THIS?

OR LACKING HIGHS AND LOWS LIKE THIS?

5 types of Vari-tone units are now available to meet circuit requirements in receivers, amplifiers or telephone lines.

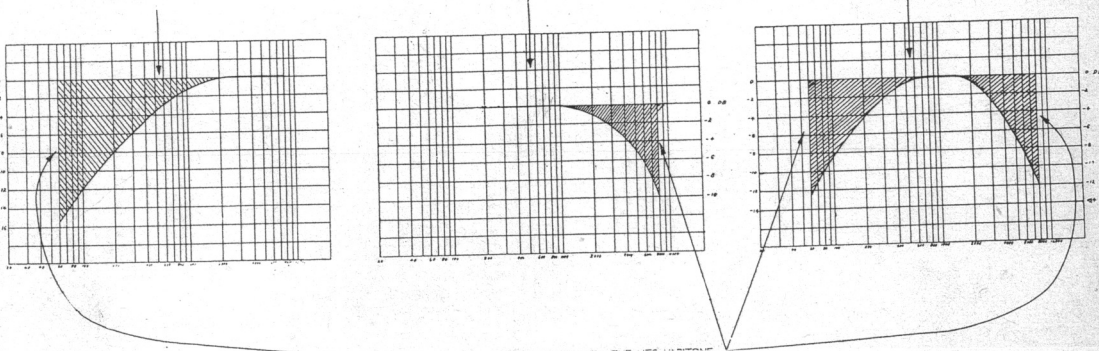

*Patent applied for

THESE LOST NOTES CAN BE REGAINED WITH THE UTC VARITONE.

	List Price	Net Price	List Price	Net Price	
VT-1—Designed to work from a single plate or low impedance line of 200 or 500 ohms to one or two grids. Highs or lows can be augmented or diminished to equalize frequency range of receiver or amplifier.....	\$8.50	\$5.10			
VT-2—Designed for insertion across a 200 or 500 ohm line or across a 5,000 to 20,000 ohm plate.....	6.00	3.60			
VT-3—A complete self-contained unit adjusted for 10 DB equalization at 80 and 7000 cycles. Will increase depth and brilliance of average receiver or amplifier.....	5.00	3.00			
			VT-4—A complete unit including variable control so arranged that with the control at one end high fidelity performance is effected by the increase of low and high frequencies, and with the control at the other end the high response is reduced to decrease static line noises and heterodyne whistles. Used with triode tubes.....	6.00	3.60
			VT-5—Same as VT-4, but used with screen grid tubes, pentodes or high mu triodes.....	6.00	3.60

For complete description of Varitone circuit applications write for Varitone 1120 Bulletin.

Three Outstanding Chromshield Amplifier Kits for the Ham or PA Engineer

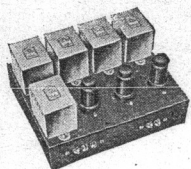

CK-7 Metal Tube Preamplifier Kit. Uses two metal 6C5 tubes in cascade amplification. A third 6C5 is used as a rectifier. Can be operated on AC or DC current. Hum Free, noise free, and trouble free in operation. Overall gain 55 DB, input and output impedances 50, 200 or 500 ohms.

CK-7 Preamplifier kit fully mounted on chassis, including all necessary resistors, condensers, sockets,

line cord, plug, hardware, ready to wire:

List Price \$22.00
Net Price \$13.20

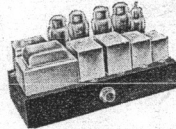

CK-3 Class B 46 Amplifier Kit. Uses a high mu 57, 46 driver and class B 46's. Output will match an RF load of 5000 or 3000 ohms. Gain 84 DB. Normal output 30 watts.

CK-3 Amplifier Kit fully mounted on chassis including all accessories, except tubes, ready to wire:

List Price \$35.00
Net Price \$21.00

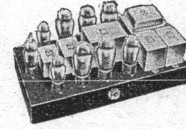

CK-4 Super Power A Prime Amplifier Kit. Uses 1-57, 2-56's, 4-45's in A prime or 4-2A3's. Normal output 30 watts, peak output 40 watts. Gain 85 DB. Output will match RF load of 10,000, 7,000, or 5,000 ohms. Different output will match 500, 15, 8, 4, 2 ohm lines.

CK-4 amplifier kit fully mounted on chassis including all accessories except tubes, ready to wire:

List Price \$44.50
Net Price \$26.70

UNITED TRANSFORMER CORP.

72-78 SPRING STREET

Export Division, 15 Laight St., New York, N. Y.

NEW YORK, N. Y.

Exclusive UTC distributors carrying a complete stock of UTC products.

Goldhamer's, Inc.	610 Huron Road, Cleveland, Ohio	Hall's	35 So. Cameron, Harrisburgh, Penna.
Wholesale Radio Service Co., Inc.	100 Sixth Ave., New York, N. Y.	Herbach & Rademan	438 Market St., Philadelphia, Penna.
Wholesale Radio Service Co., Inc.	219 Central Ave., Newark, N. J.	Cameradio Company	603 Grant Street, Pittsburgh, Pa.
Wholesale Radio Service Co., Inc.	430 W. Peachtree St. N. W., Atlanta, Ga.	W. H. Edwards & Co.	32 Bway, Providence, R. I.
Wholesale Radio Service Co., Inc.	911 Jackson Blvd., Chicago, Ill.	Seattle Radio Supply, Inc.	2319 Second Ave., Seattle, Wash.
Sun Radio	227 Fulton Street, New York, N. Y.	Portland Radio Supply Co.	1300 W. Burnside, Portland, Ore.
Gross Radio, Inc.	51 Vesey Street, New York City	Spokane Radio Co., Inc.	611 First Ave., Spokane, Wash.
Leeds	45 Vesey Street, New York City	San Francisco Radio Exchange	1284 Market St., San Francisco, Calif.
South West Radio Supply	107 South St. Paul St., Dallas, Texas	Straus Frank Co.	San Antonio, Galveston, Houston and Austin, Texas
Mohawk Electric Co.	1335 State St., Schenectady, N. Y.	SOUTHERN CALIFORNIA	
Walter Ashe	1100 Pine St., St. Louis, Mo.	Pacific Radio Exchange Inc.	729 S. Main St., Los Angeles
Radio Shack	46 Brattle St., Boston, Mass.	Radio Supply Co.	912-14 S. Broadway, Los Angeles
Harvey's Radio	105 W. 43rd St., New York, N. Y.	Coast Electric Co.	744 G. St., San Diego
United Radio Service	616 Main St., New Britain, Conn.	Prest & Dean Radio Co.	400 American Avenue, Long Beach
Hatry & Young	203 Ann St., Hartford, Conn.	Radio Television Supply Co.	1701 S. Grand Ave., Los Angeles, Calif.
Marine Radio Co.	124-13 101st Avenue, Richmond Hill, N. Y.	Radio Specialties Co.	1516 West 8th St., Los Angeles, Calif.
	Film et Radio		5 Rue Denis Poisson, Paris, France