

RCA

Receiving Tube Manual

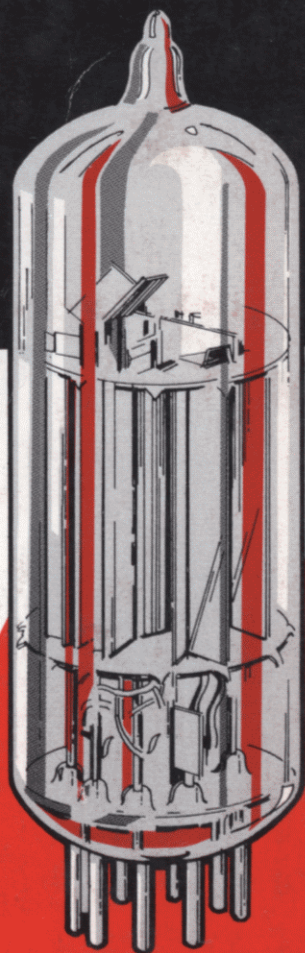

Including Picture
Tubes and Industrial
Receiving Tubes

RC-30

\$2.95 Optional Price

RCA

Receiving Tube Manual

**Including Picture
Tubes and Industrial
Receiving Tubes**

THIS MANUAL, like its many predecessors, has been prepared to assist those who work or experiment with home-entertainment or industrial receiving types of electron tubes and circuits or with television picture tubes. It will be found valuable by engineers, service technicians, educators, experimenters, electricians, radio amateurs, hobbyists, students, and others interested in electron tubes and their applications.

Easy-to-read chapters explain the basic principles of operation, significant electrical characteristics, circuit applications, and testing of various types of electron tubes. Technical data are given on current RCA home-entertainment and industrial receiving-type tubes and on picture tubes. Circuit diagrams are given illustrating the use of RCA tubes in many practical applications. Also included are expanded and updated replacement guides for obsolete or hard-to-find industrial and home-entertainment receiving tubes.

RCA | Distributor and Special Products Division
Cherry Hill Offices | Camden, N.J. 08101

Copyright 1975 by RCA Corporation

(All rights reserved under Pan-American Copyright Convention)

Printed in U.S.A. 8/75

Contents

	PAGE
ELECTRONS, ELECTRODES, AND ELECTRON TUBES	3
ELECTRON TUBE CHARACTERISTICS	13
ELECTRON TUBE APPLICATIONS	15
ELECTRON TUBE INSTALLATION	81
SAFETY PRECAUTIONS—RECEIVING TUBES, PICTURE TUBES	93
INTERPRETATION OF TUBE DATA	95
ELECTRON TUBE TESTING	100
APPLICATION GUIDE FOR RECEIVING TUBES	104
TECHNICAL DATA FOR RECEIVING TUBES— ENTERTAINMENT AND INDUSTRIAL TYPES	111
CHARACTERISTICS CHART FOR ENTERTAINMENT AND INDUSTRIAL RECEIVING TUBES (includes discontinued types)	522
TERMINAL DIAGRAMS FOR RECEIVING TUBES	594
OUTLINES	633
STRUCTURE OF A MINIATURE TUBE	640
RESISTANCE-COUPLED AMPLIFIERS	641
REPLACEMENT GUIDE— ENTERTAINMENT RECEIVING TYPES	650
REPLACEMENT GUIDE— INDUSTRIAL RECEIVING TYPES	657
PICTURE TUBE CHARACTERISTICS CHART	666
TERMINAL DIAGRAMS FOR PICTURE TUBES	672
CIRCUITS	674
INDEX	750

Information furnished by RCA is believed to be accurate and reliable. However, no responsibility is assumed by RCA for its use; nor for any infringements of patents or other rights of third parties which may result from its use. No license is granted by implication or otherwise under any patent or patent rights of RCA.

Electrons, Electrodes and Electron Tubes

THE electron tube is a marvelous device. It makes possible the performing of operations, amazing in conception, with a precision and a certainty that are astounding. It is an exceedingly sensitive and accurate instrument—the product of coordinated efforts of engineers and craftsmen. Its construction requires materials from every corner of the earth. Its use is world-wide.

The importance of the electron tube lies in its ability to control almost instantly the flight of the millions of electrons supplied by the cathode. It accomplishes this control with a minimum of energy. Because it is almost instantaneous in its action, the electron tube can operate efficiently and accurately at extremely high electrical frequencies.

Electrons

All matter exists in the solid, liquid, or gaseous state. These three forms consist entirely of minute divisions known as molecules, which, in turn, are composed of atoms. Atoms have a nucleus which is a positive charge of electricity, around which revolve tiny charges of negative electricity known as **electrons**. Scientists have estimated that electrons weigh only 1/30-billion, billion, billion, billionths ($\frac{1}{30} \times 10^{-36}$) of an ounce, and that they may travel at speeds of thousands of miles per second.

Electron movement may be accelerated by the addition of energy. Heat is one form of energy which can be conveniently used to speed up the electron.

For example, if the temperature of a metal is gradually raised, the electrons in the metal gain velocity. When the metal becomes hot enough, some electrons may acquire sufficient speed to break away from the surface of the metal. This action, which is accelerated when the metal is heated in a vacuum, is utilized in most electron tubes to produce the necessary electron supply.

An electron tube consists of a cathode, which supplies electrons, and one or more additional electrodes, which control and collect these electrons, mounted in an evacuated envelope. The envelope may be made of glass, metal, ceramic, or a combination of these materials.

Cathodes

A cathode is an essential part of an electron tube because it supplies the electrons necessary for tube operation. When energy in some form is applied to the cathode, electrons are released. Heat is the form of energy generally used. The method of heating the cathode may be used to distinguish between the different forms of cathodes. For example, a directly heated cathode, or filament-cathode, is a wire heated by the passage of an electric current. An indirectly heated cathode, or heater-cathode, consists of a filament, or heater, enclosed in a metal sleeve. The sleeve carries the electron-emitting material on its outside surface and is heated by radiation and conduction from the heater.

A **filament, or directly heated cathode**, such as that shown in Fig. 1 may

be further classified by identifying the filament or electron-emitting material. The materials in regular use are tungsten, thoriated tungsten, and metals which have been coated with alkaline-earth oxides. Tungsten filaments are made from the pure metal. Because they must operate at high temperatures (a dazzling white) to emit sufficient electrons, a relatively large amount of filament power is required.

Thoriated-tungsten filaments are made from tungsten impregnated with thorium oxide. Due to the presence of thorium, these filaments liberate electrons at a more moderate temperature of about 1700°C (a bright yellow) and are, therefore, much more economical of filament power than are pure tungsten filaments.

Alkaline earths are usually applied as a coating on a nickel-alloy wire or ribbon. This coating, which is dried in a relatively thick layer on the filament, requires only a relatively low temperature of about $700\text{--}750^{\circ}\text{C}$ (a dull red) to produce a copious supply of electrons. Coated filaments operate very efficiently and require relatively little filament power. However, each of these cathode materials has special advantages which determine the choice for a particular application.

Directly heated filament-cathodes require comparatively little heating power. They are used in tube types designed for battery operation because it is, of course, desirable to impose as small a drain as possible on the batteries. They are also used in rectifiers such as the 1G3GTA/1B3GT and the 5Y3GT.

An **indirectly heated cathode**, or **heater-cathode**, consists of a thin metal sleeve coated with electron-emitting material such as alkaline-earth oxides. The emissive surface of the cathode is maintained at the required temperature (approximately 1050°K) by resistance-heating of a tungsten or tungsten-alloy wire which is placed inside the cathode sleeve and electrically insulated from it, as shown in Fig. 2. The heater is used only for the purpose of heating the cathode sleeve and sleeve coating to an electron-emitting temperature.

Useful emission does not take place from the heater wire.

A new dark heater insulating coating developed by RCA has better heat transfer than earlier aluminum-oxide coatings, and makes it possible to operate heaters at lower temperatures for given power inputs. Because the tensile strength of the heater wire increases at the lower operating temperatures, tubes using **dark heaters** have increased reliability, stability, and life.

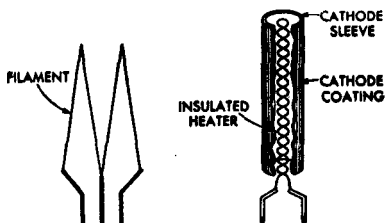

Fig. 1—Filament or directly heated cathode. Fig. 2—Indirectly heated cathode or heater-cathode.

The heater-cathode construction is well adapted for use in electron tubes intended for operation from ac power lines and from storage batteries. The use of separate parts for emitter and heater functions, the electrical insulation of the heater from the emitter, and the shielding effect of the sleeve may all be utilized in the design of the tube to minimize the introduction of hum from the ac heater supply and to minimize electrical interference which might enter the tube circuit through the heater-supply line. From the viewpoint of circuit design, the heater-cathode construction offers advantages in connection flexibility because of the electrical separation of the heater from the cathode.

Another advantage of the heater-cathode construction is that it makes practical the design of a rectifier tube having close spacing between its cathode and plate, and of an amplifier tube having close spacing between its cathode and grid. In a close-spaced rectifier tube, the voltage drop in the tube is low, and, therefore, the regulation is improved. In an amplifier tube, the close spacing increases the gain obtainable from the tube. Because of the

advantages of the heater-cathode construction, almost all present-day receiving tubes designed for ac operation have heater-cathodes.

Generic Tube Types

Electrons are of no value in an electron tube unless they can be put to work. Therefore, a tube is designed with the parts necessary to utilize electrons as well as those required to produce them. These parts consist of a cathode and one or more supplementary electrodes. The electrodes are enclosed in an evacuated envelope having the necessary connections brought out through air-tight seals. The air is removed from the envelope to allow free movement of the electrons and to prevent injury to the emitting surface of the cathode.

When the cathode is heated, electrons leave the cathode surface and form an invisible cloud in the space around it. Any positive electric potential within the evacuated envelope offers a strong attraction to the electrons (unlike electric charges attract; like charges repel). Such a positive electric potential can be supplied by an **anode** (positive electrode) located within the tube in proximity to the cathode.

Diodes

The simplest form of electron tube contains two electrodes, a cathode and an anode (plate), and is often called a diode, the family name for a two-electrode tube. In a diode, the positive potential is supplied by a suitable electrical source connected between the plate terminal and a cathode terminal, as shown in Fig. 3. Under the influence of the positive plate potential, electrons

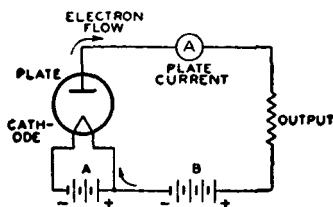

Fig. 3—Basic diode circuit.

flow from the cathode to the plate and return through the external plate-battery circuit to the cathode, thus completing the circuit. This flow of electrons is known as the **plate current**.

If a negative potential is applied to the plate, the free electrons in the space surrounding the cathode will be forced back to the cathode and no plate current will flow. If an alternating voltage is applied to the plate, the plate is alternately made positive and negative. Because plate current flows only during the time when the plate is positive, current flows through the tube in only one direction and is said to be rectified. Fig. 4 shows the rectified output current produced by an alternating input voltage.

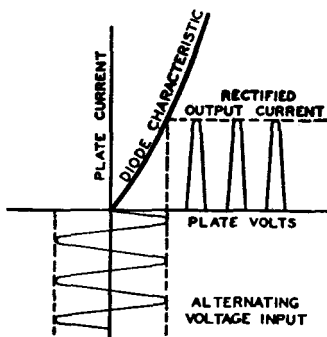

Fig. 4—Current characteristics of rectifier circuit.

Diode rectifiers are used in ac receivers to convert the ac supply voltage to dc voltage for the electrodes of the other tubes in the receiver. Rectifier tubes having only one plate and one cathode, such as the 35W4, are called **half-wave rectifiers**, because current can flow only during one-half of the alternating-current cycle. When two plates and one or more cathodes are used in the same tube, current may be obtained on both halves of the ac cycle. The 6X4, 5Y3GT, and 5U4GB are examples of this type and are called **full-wave rectifiers**.

Not all of the electrons emitted by the cathode reach the plate. Some return to the cathode, while others remain in the space between the cathode and plate for a brief period to produce

an effect known as **space charge**. This charge has a repelling action on other electrons which leave the cathode surface and impedes their passage to the plate. The extent of this action and the amount of space charge depend on the cathode temperature, the distance between the cathode and the plate, and the plate potential. The higher the plate potential, the less is the tendency for electrons to remain in the space-charge region and repel other electrons. This effect may be noted by applying increasingly higher plate voltages to a tube operating at a fixed heater or filament voltage. Under these conditions, the maximum number of available electrons is fixed, but increasingly higher plate voltages will succeed in attracting a greater proportion of the free electrons.

Beyond a certain plate voltage, however, additional plate voltage has little effect in increasing the plate current because all of the electrons emitted by the cathode are already being drawn to the plate. This maximum current, illustrated in Fig. 5, is called **saturation current**. Because it is an indication of the total number of electrons emitted, it is also known as **emission current** or simply **emission**.

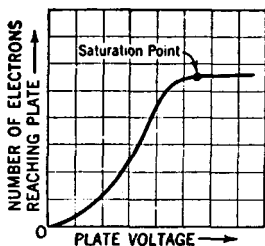

Fig. 5—Current characteristic of diode tube.

Although tubes are sometimes tested by measurement of their emission current, it is generally not advisable to measure the full value of emission because this value would be sufficiently large to cause change in the tube characteristics or even to damage the tube. Consequently, while the test value of emission current is somewhat larger than the maximum current which will be required from the cathode in the

use of the tube, it is ordinarily less than the full emission current. The emission test, therefore, is used to indicate whether the cathode can supply a sufficient number of electrons for satisfactory operation of the tube.

If space charge were not present to repel electrons coming from the cathode, the same plate current could be produced at a lower plate voltage. One way to make the effect of space charge small is to make the distance between plate and cathode small. This method is used in rectifier types having heater-cathodes, such as the 5V4GA and the 6AX5GT. In these types, the radial distance between cathode and plate is only about two hundredths of an inch.

Another method of reducing space-charge effect is utilized in **mercury-vapor rectifier tubes**. When such tubes are operated, a small amount of mercury contained in the tube is partially vaporized, filling the space inside the bulb with mercury atoms. These atoms are bombarded by electrons on their way to the plate. If the electrons are moving at a sufficiently high speed, the collisions tear off electrons from the mercury atoms. The mercury atom is then said to be "**ionized**," *i.e.*, it has lost one or more electrons and, therefore, has a positive charge. Ionization is evidenced by a bluish-green glow between the cathode and plate. When ionization occurs, the space charge is neutralized by the positive mercury atoms so that increased numbers of electrons are made available. Mercury-vapor tubes are used primarily for power rectifiers.

Ionic-heated-cathode rectifiers depend on gas ionization for their operation. These tubes are of the full-wave design and contain two anodes and a coated cathode sealed in a bulb containing a reduced pressure of inert gas. The cathode becomes hot during tube operation, but the heating effect is caused by bombardment of the cathode by ions within the tube rather than by heater or filament current from an external source.

The internal structure of an ionic-heated-cathode tube is designed so that when sufficient voltage is applied to the tube, ionization of the gas occurs be-

tween the anode which is instantaneously positive and the cathode. Under normal operating voltages, ionization does not take place between the anode that is negative and the cathode, so that the requirements for rectification are satisfied. The initial small flow of current through the tube is sufficient to raise the cathode temperature quickly to incandescence, whereupon the cathode emits electrons. The voltage drop in such tubes is slightly higher than that of the usual hot-cathode gas rectifiers because energy is taken from the ionization discharge to keep the cathode at operating temperature. Proper operation of these rectifiers requires a minimum flow of load current at all times to maintain the cathode at the temperature required to supply sufficient emission.

Triodes

When a third electrode, called the **control grid**, is placed between the cathode and plate, the tube is known as a triode, the family name for a three-electrode tube. The grid usually consists of relatively fine wire wound on two support rods (siderods) and extending the length of the cathode. The spacing between turns of wire is large compared with the size of the wire so that the passage of electrons from cathode to plate is practically unobstructed by the grid. In some types, a **frame grid** is used. The frame consists of two siderods supported by four metal straps. Extremely fine lateral wire (diameter of 0.5 mil or less) is wound under tension around the frame. This type of grid permits the use of closer spacings between grid wires and between tube electrodes, and thus improves tube performance.

The purpose of the grid is to control the flow of plate current. When a tube is used as an amplifier, a negative dc voltage is usually applied to the grid. Under this condition the grid does not draw appreciable current.

The number of electrons attracted to the plate depends on the combined effect of the grid and plate polarities, as shown in Fig. 6. When the plate is positive, as is normal, and the dc grid volt-

age is made more and more negative, the plate is less able to attract electrons to it and plate current decreases. When the grid is made less and less negative (more and more positive), the plate more readily attracts electrons to it and plate current increases. Hence, when the voltage on the grid is varied in accordance with a signal, the plate current varies with the signal. Because a small voltage applied to the grid can control a comparatively large amount of plate current, the signal is amplified by the tube. Typical three-electrode tube types are the 6C4 and 6AF4A.

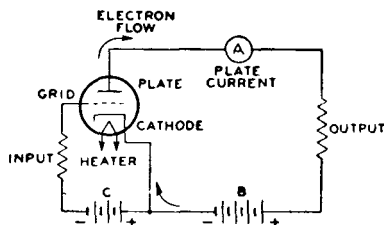

Fig. 6—Basic triode circuit.

The grid, plate, and cathode of a triode form an electrostatic system, each electrode acting as one plate of a small capacitor. The capacitances are those existing between grid and plate, plate and cathode, and grid and cathode. These capacitances are known as **inter-electrode capacitances**. Generally, the capacitance between grid and plate is of the most importance. In high-gain radio-frequency amplifier circuits, this capacitance may act to produce undesired coupling between the **input circuit**, the circuit between grid and cathode, and the **output circuit**, the circuit between plate and cathode. This coupling is undesirable in an amplifier because it may cause instability and unsatisfactory performance.

Tetrodes

The capacitance between control grid and plate can be made small by mounting an additional electrode, called the **screen grid** (grid No. 2), in the tube. With the addition of the grid No. 2, the tube has four electrodes and is, accordingly, called a tetrode. The screen

grid or grid No. 2 is mounted between the grid No. 1 (control grid) and the plate, as shown in Fig. 7, and acts as an electrostatic shield between them, thus reducing the grid-to-plate capacitance. The effectiveness of this shielding action is increased by a bypass

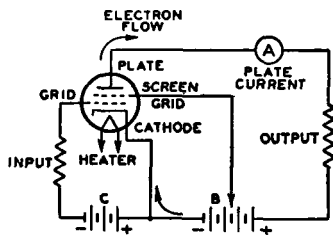

Fig. 7—Basic tetrode circuit.

capacitor connected between screen grid and cathode. By means of the screen grid and this bypass capacitor, the grid-plate capacitance of a tetrode is made very small. In practice, the grid-plate capacitance is reduced from several picofarads (pF) for a triode to 0.01 pF or less for a screen-grid tube.

The screen grid has another desirable effect in that it makes plate current practically independent of plate voltage over a certain range. The screen grid is operated at a positive voltage and, therefore, attracts electrons from the cathode. However, because of the comparatively large space between wires of the screen grid, most of the electrons drawn to the screen grid pass through it to the plate. Hence, the screen grid supplies an electrostatic force pulling electrons from the cathode to the plate. At the same time, the screen grid shields the electrons between cathode and screen grid from the plate so that the plate exerts very little electrostatic force on electrons near the cathode.

So long as the plate voltage is higher than the screen-grid voltage, plate current in a screen-grid tube depends to a great degree on the screen-grid voltage and very little on the plate voltage. The fact that plate current in a screen-grid tube is largely independent of plate voltage makes it possible to obtain much higher amplification with a tetrode than with a triode. The

low grid-plate capacitance makes it possible to obtain this high amplification without plate-to-grid feedback and resultant instability. In receiving-tube applications, the tetrode has been replaced to a considerable degree by the pentode.

Pentodes

In all electron tubes, electrons striking the plate may, if moving at sufficient speed, dislodge other electrons. In two- and three-electrode types, these dislodged electrons usually do not cause trouble because no positive electrode other than the plate itself is present to attract them. These electrons, therefore, are drawn back to the plate. Emission caused by bombardment of an electrode by electrons from the cathode is called **secondary emission** because the effect is secondary to the original cathode emission.

In the case of screen-grid tubes, the proximity of the positive screen grid to the plate offers a strong attraction to these secondary electrons, and particularly so if the plate voltage swings lower than the screen-grid voltage. This effect reduces the plate current and limits the useful plate-voltage swing for tetrodes.

The effects of secondary emission are minimized when a fifth electrode is placed within the tube between the screen grid and plate. This fifth electrode is known as the **suppressor grid** (grid No. 3) and is usually connected to the cathode, as shown in Fig. 8. Because of its negative potential with respect to the plate, the suppressor grid retards the flight of secondary electrons and diverts them back to the plate.

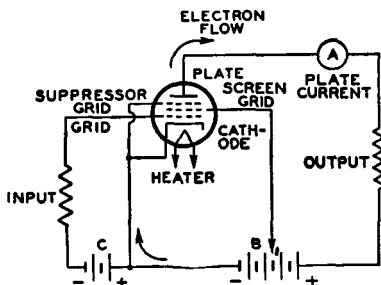

Fig. 8—Basic pentode circuit.

The family name for a five-electrode tube is "pentode." In power-output pentodes, the suppressor grid makes possible higher power output with lower grid-driving voltage; in radio-frequency amplifier pentodes, the suppressor grid makes possible high voltage amplification at moderate values of plate voltage. These desirable features result from the fact that the plate-voltage swing can be made very large. In fact, the plate voltage may be as low as, or lower than, the screen-grid voltage without serious loss in signal-gain capability. Representative pentodes used for power amplification are the 6CL6 and 6K6GT; representative pentodes used for voltage amplification are the 6AU6A, 6BA6, and 5879.

Beam Power Tubes

A beam power tube is a tetrode or pentode in which directed electron beams are used to increase substantially the power-handling capability of the tube. Such a tube contains a cathode, a control grid (grid No. 1), a screen grid (grid No. 2), a plate, and, optionally, a suppressor grid (grid No. 3). When a beam power tube is designed without an actual suppressor grid, the electrodes are so spaced that secondary emission from the plate is suppressed by space-charge effects between screen grid and plate. The space charge is produced by the slowing up of electrons traveling from a high-potential screen grid to a lower-potential plate. In this low-velocity region, the space charge produced is sufficient to repel secondary electrons emitted from the plate and to cause them to return to the plate.

Beam power tubes of this design employ beam-confining electrodes at cathode potential to assist in producing the desired beam effects and to prevent stray electrons from the plate from returning to the screen grid outside of the beam. A feature of a beam power tube is its low screen-grid current. The screen grid and the control grid are spiral wires wound so that each turn of the screen grid is shaded from the cathode by a grid turn. This alignment of the screen

grid and control grid causes the electrons to travel in sheets between the turns of the screen grid so that very few of them strike the screen grid. Because of the effective suppressor action provided by space charge and because of the low current drawn by the screen grid, the beam power tube has the advantages of high power output, high power sensitivity, and high efficiency.

Fig. 9 shows the structure of a beam power tube employing space-charge suppression and illustrates how

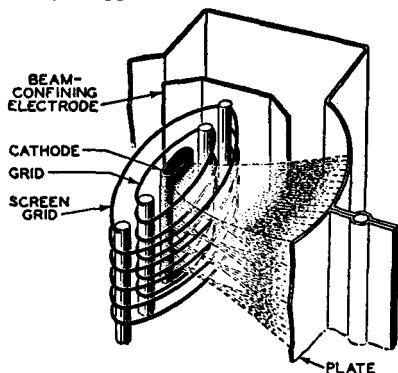

Fig. 9—Structure of beam power tube showing beam-confining action.

the electrons are confined to beams. The beam condition illustrated is that for a plate potential less than the screen-grid potential. The high-density space-charge region is indicated by the heavily dashed lines in the beam. Note that the edges of the beam-confining electrodes coincide with the dashed portion of the beam. In this way the space-charge potential region is extended beyond the beam boundaries and stray secondary electrons are prevented from returning to the screen grid outside of the beam. The space-charge effect may also be obtained by use of an actual suppressor grid. Examples of beam power tubes are 6AQ5A, 6L6GC, 6V6GTA, and 50C5.

Multi-Electrode and Multi-Unit Tubes

Early in the history of tube devel-

opment and application, tubes were designed for a general service; that is, a single tube type—a triode—was used as a radio-frequency amplifier, an intermediate-frequency amplifier, an audio-frequency amplifier, an oscillator, or a detector. Obviously, with this diversity of application, one tube did not meet all requirements to the best advantage.

Later and present trends of tube design are the development of "specialty" types. These types are intended either to give optimum performance in a particular application or to combine in one bulb functions which formerly required two or more tubes. The first class of tubes includes such examples of specialty types as the 6CB6A and 6BY6. Types of this class generally require more than three electrodes to obtain the desired special characteristics and may be broadly classed as multi-electrode types. The 6BY6 is an especially interesting type in this class. This tube has an unusually large number of electrodes, namely seven, exclusive of the heater. Plate current in the tube is varied at two different frequencies at the same time. The tube is designed primarily for use as a combined sync separator and sync clipper in television receivers.

The second class includes multi-unit tubes such as the twin-diode triodes 6CN7 and 6AV6, as well as triode-pentodes such as the 6EA8 and 6GH8A. This class also includes class A twin triodes such as the 6FQ7/6CG7 and 12AX7A, and types such as the 6CM7 containing dissimilar triode units used primarily as combined vertical oscillators and vertical deflection amplifiers in television receivers. Full-wave rectifiers are also multi-unit types.

A third class of tubes combines features of each of the other two classes. Typical of this third class are the pentagrid-converter types 6BE6 and 6SA7. These tubes are similar to the multi-electrode types in that they have seven electrodes, all of which affect the electron stream; and they are similar to the multi-unit tubes in that they perform simultaneously the double function of oscillator and mixer in superheterodyne receivers.

Receiving Tube Structure

Receiving tubes generally utilize a glass or metal envelope and a base. Originally, the base was made of metal or molded phenolic material. Types having a glass envelope and a molded phenolic base include the "octal" types such as the 5U4GB and the 6SN7GTB. Types having a metal envelope and molded phenolic octal base include the 6V6 and the 6L6. Many modern types utilize integral glass bases. Present-day conventional tube designs utilizing glass envelopes and integral glass bases include the seven-pin and nine-pin **miniature** types, the nine-pin **novar** and **neonov**al types, and the twelve-pin **duodec**ar types. Examples of the seven-pin miniature types are the 6AU6A and 6AV6. Examples of the nine-pin miniature types are the 12AU7A and 6EA8. Examples of the novar types are the 6CJ3 and 7868. The nine-pin base for the novar types has a relatively large pin-circle diameter and long pins to insure firm retention of the tube in its socket.

The **nuvistor** concept provided a new approach to electron tube design. Nuvistor tubes utilize a light-weight cantilever-supported cylindrical electrode structure housed in a ceramic-metal envelope. These tubes combine new materials, processes, and fabrication techniques. Examples of the nuvistor are the 6CW4 and the 6DV4.

Television Picture Tubes

The picture tube, or kinescope, is a multi-electrode tube used principally in television receivers for picture display. It consists essentially of an electron gun, a glass or metal-and-glass envelope and faceplate combination, and a fluorescent screen.

The electron gun includes a cathode for the production of free electrons, one or more control electrodes for accelerating the electrons in the beam, and, optionally, a device for "trapping" unwanted ions out of the electron beam.

Focusing of the beam is accomplished either electromagnetically by

means of a focusing coil placed on the neck of the tube, or electrostatically, as shown in Fig. 10, by means of a focusing electrode (grid No. 4) within the envelope of the tube. The screen is a white-fluorescing phosphor P4 of either the silicate or the sulfide type.

Deflection of the beam is accomplished either electrostatically by means of deflecting electrodes within the envelope of the tube, or electromagnetically by means of a deflecting yoke placed on the neck of the tube. Fig. 10 shows the structure of the gun section of a picture tube and illustrates how the electron beam is formed and how the beam is deflected by means of an electromagnetic deflecting yoke. In this type of tube, ions in the beam are prevented from damaging the fluorescent screen by an aluminum film on the gun side of the screen. This film not only "traps" unwanted ions, but also improves picture contrast. In many types of non-aluminized tubes, ions are separated from the electron beam by means of a tilted-gun and ion-trap-magnet arrangement.

Color television picture tubes are similar to black-and-white picture tubes, but differ in three major ways: (1) The light-emitting screen is made up of trios

of phosphor dots deposited in an interlaced pattern. Each dot of a trio is capable of emitting light in one of the three primary colors (red, green, or blue). (2) A shadow mask mounted near the screen of the tube contains over 300,000 apertures, one for each of the phosphor dot trios. This mask provides color separation by shadowing two of the three phosphor dots of each trio. (3) Three closely spaced electron guns, built as a unit, provide separate beams for excitation of the three different color-phosphor-dot arrays. Thus it is possible to control the brightness of each of the three colors independently of the other two. Fig. 11 shows a cut-away view of a color television picture tube.

The three electron guns are mounted with their axes tilted toward the central axis of the envelope, and are spaced 120 degrees with respect to each other. The focusing electrodes of the three guns are interconnected internally, and their potential is adjusted to cause the separate beams to focus at the phosphor-dot screen. All three beams must be made to converge at the screen while they are simultaneously being deflected. Convergence is accomplished by the action of static and

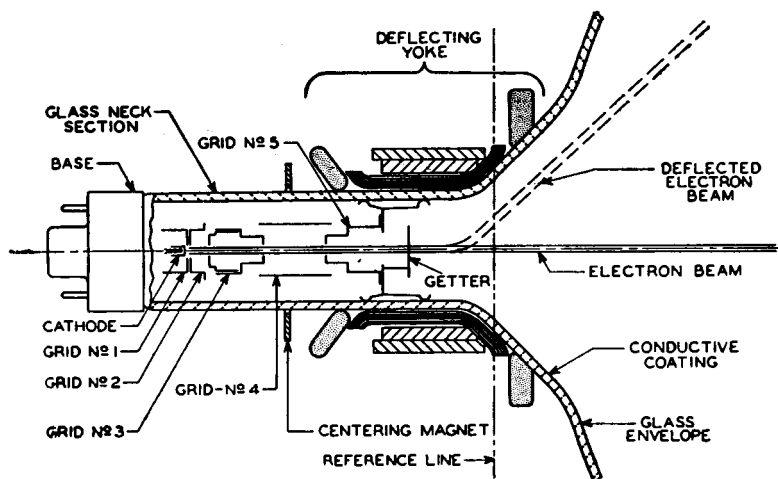

Fig. 10—Structure of television-picture-tube electron gun.

dynamic magnetic fields set up by the radial-converging magnet assembly mounted on the neck of the tube. These fields are coupled into the radial-converging pole pieces within the tube. Another pair of pole pieces in the tube is activated by the lateral-converging magnet also mounted on the neck of the tube. These pole pieces permit lateral shift in position of the blue beam in opposition to the lateral shift of the green and red beams.

A purifying magnet is used with color picture tubes to provide a magnetic field, adjustable in magnitude and direction, to effect register over the entire area of the screen. A magnetic shield is used to minimize the effects of the earth's magnetic field.

Deflection of the three beams is accomplished simultaneously by a deflecting yoke using four electromagnetic coils similar to the deflecting yoke used for black-and-white picture tubes.

A totally new concept in color television display systems utilizing an advanced design of electron gun, deflection yoke, and picture tube has

been developed by RCA. Instead of dots, this tube utilizes a screen consisting of continuous vertical phosphor lines of alternating green, red, and blue emitting phosphors. The mask apertures are vertical slits with small cross ties to provide strength. This line-screen arrangement has the advantage of reducing beam-to-phosphor misregister, enhancing color purity, and improving white uniformity.

The electron gun of this tube uses a horizontal in-line structure rather than the 120° spacing of the phosphor-dot tube and is designed for use with a precision static toroid line-focus-type deflecting yoke. With this structure, the three beams and the deflecting field are in precise alignment. As a result, this precision in-line tube assembly is inherently self-converging and does not require dynamic convergence correction or its associated circuitry. Consequently, the deflecting yoke and neck components can be pre-adjusted and permanently attached to the picture tube by the tube manufacturer.

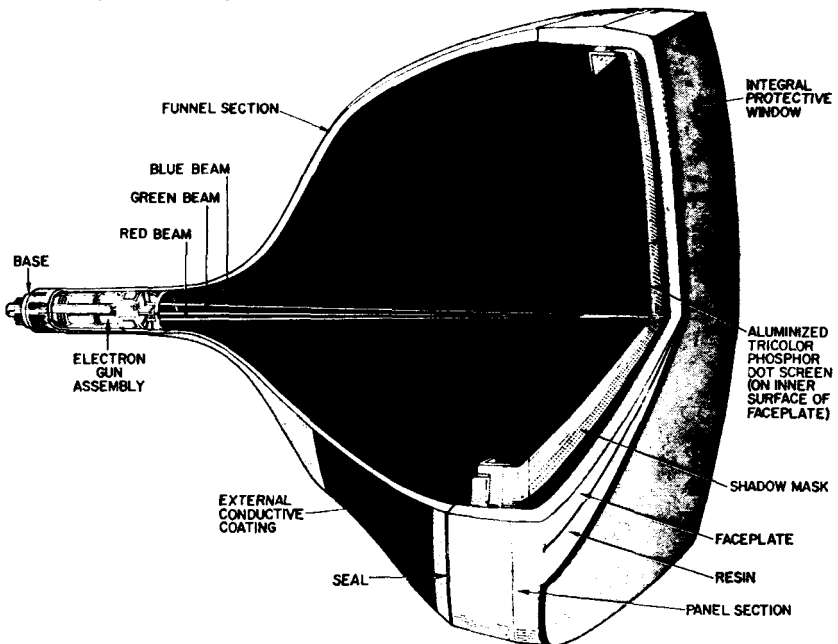

Fig. 11—Cutaway view of color television picture tube.

Electron Tube Characteristics

THE term "characteristics" is used to identify the distinguishing electrical features and values of an electron tube. These values may be shown in curve form or they may be tabulated. When the characteristics values are given in curve form, the curves may be used for the determination of tube performance and the calculation of additional tube factors.

Tube characteristics are obtained from electrical measurements of a tube in various circuits under certain definite conditions of voltages. Characteristics may be further described by denoting the conditions of measurements. For example, Static Characteristics are the values obtained with different dc potentials applied to the tube electrodes, while Dynamic Characteristics are the values obtained with an ac voltage on a control grid under various conditions of dc potentials on the electrodes. The dynamic characteristics, therefore, are indicative of the performance capabilities of a tube under actual working conditions.

Static characteristics may be shown by plate characteristics curves and transfer (mutual) characteristics curves. These curves present the same information, but in two different forms to increase its usefulness. The plate characteristic curve is obtained by varying plate voltage and measuring plate current for different grid-bias voltages, while the transfer-characteristic curve is obtained by varying grid-bias voltage and measuring plate current for different plate voltages. A plate-characteristic family of curves is shown in Fig. 12. Fig. 13 gives the transfer-characteristic family of curves for the same tube.

Dynamic characteristics include amplification factor, plate resistance, control-grid—plate transconductance, and certain detector characteristics, and may be shown in curve form for variations in tube operating conditions.

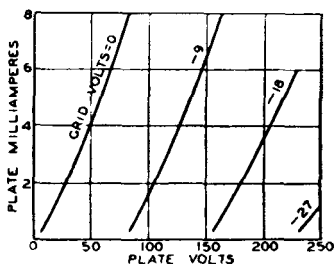

Fig. 12—Family of plate-characteristic curves.

The amplification factor, or μ , is the ratio of the change in plate voltage to a change in control-electrode voltage in the opposite direction, under the condition that the plate current remains

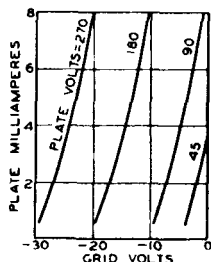

Fig. 13—Family of transfer-characteristic curves.

unchanged and that all other electrode voltages are maintained constant. For example, if, when the plate voltage is made 1 volt more positive, the control-electrode (grid-No. 1) voltage must be made 0.1 volt more negative to hold plate current unchanged, the amplification factor is 1 divided by 0.1, or 10. In other words, a small voltage variation in the grid circuit of a tube has the same effect on the plate current as a large plate-voltage change—the latter equal to the product of the grid-voltage change and amplification factor. The μ of a tube is often useful for

calculating stage gain. This use is discussed in the **Electron Tube Applications** section.

Plate resistance (r_p) of an electron tube is the resistance of the path between cathode and plate to the flow of alternating current. It is the quotient of a small change in plate voltage divided by the corresponding change in plate current and is expressed in ohms, the unit of resistance. Thus, if a change of 0.1 milliamperere (0.0001 ampere) is produced by a plate-voltage variation of 1 volt, the plate resistance is 1 divided by 0.0001, or 10000 ohms.

Control grid-to-plate transconductance, or simply **transconductance** (g_m), is a factor which combines in one term the amplification factor and the plate resistance, and is the quotient of the first divided by the second. This term has also been known as mutual conductance. Transconductance may be more strictly defined as the quotient of a small change in plate current (amperes) divided by the small change in the control-grid voltage producing it, under the condition that all other voltages remain unchanged. Thus, if a grid-voltage change of 0.5 volt causes a plate-current change of 1 milliamperere (0.001 ampere), with all other voltages constant, the transconductance is 0.001 divided by 0.5, or 0.002 mho. A "mho" is the unit of conductance and was named by spelling ohm backwards. For convenience, a millionth of a mho, or a micromho (μ mho), is used to express transconductance. Thus, in the example, 0.002 mho is 2000 micromhos.

Conversion transconductance (g_c) is a characteristic associated with the mixer (first detector) function of tubes and may be defined as the quotient of the intermediate-frequency (if) current in the primary of the if transformer divided by the applied radio-frequency (rf) voltage producing it; more precisely, it is the limiting value of this quotient as the rf voltage and if current approach zero. When the performance of a frequency converter is determined, conversion transconductance is used in the same way as control grid-to-plate

transconductance is used in single-frequency amplifier computations.

The **plate efficiency** of a power amplifier tube is the ratio of the ac power output (P_o) to the product of the average dc plate voltage (E_b) and dc plate current (I_b) at full signal, or

$$\text{Plate efficiency} \% = \frac{P_o \text{ watts}}{E_b \text{ volts} \times I_b \text{ amperes}} \times 100$$

The **power sensitivity** of a tube is the ratio of the power output to the square of the input signal voltage (E_{in}), and is expressed in mhos as follows:

$$\text{Power sensitivity (mhos)} = \frac{P_o \text{ watts}}{(E_{in} \text{ rms})^2}$$

X-RADIATION CHARACTERISTICS OF TELEVISION PICTURE TUBES

X-rays are produced when the atoms of a material are bombarded by electrons (or ions). The relative intensity and spectral energy distribution of the X-radiation at the source are determined by the accelerating voltage, the electron (or ion) current, and the atomic number of the bombarded materials. Because of the selective filtering effect of the glass bulb and/or of other tube components, the relative intensity external to the tube is given by the following relationship:

$$\text{Relative Intensity} \propto iV^nZ$$

where

$$\begin{aligned} i &= \text{current} \\ V &= \text{accelerating voltage} \\ Z &= \text{atomic number of the "target"} \end{aligned}$$

In present monochrome and color picture tubes, which use high absorption glass, "n" is the order of 20.

X-radiation also may be produced in the neck by stray electrons (or ions) that are accelerated by voltages that may be as high as the anode voltage. This radiation is independent of that produced by the beam and, in fact, may be produced when there is no beam current; it is dependent upon voltages that are related to interelectrode potential differences or charge patterns on the glass, and upon leakage currents.

Electron Tube Applications

THE diversified applications of an electron receiving tube have, within the scope of this section, been treated under seven headings: Rectification; Detection; Amplification; TV Scanning, Sync, and Deflection; Oscillation; Frequency Conversion; and Tuning Indication with Electron-Ray Tubes. Although these operations may take place at either radio or audio frequencies and may involve the use of different circuits and different supplemental parts, the general considerations of each kind of operation are basic.

General System Functions

When speech, music, or video information is transmitted from a radio or television station, the station radiates a modulated radio-frequency (rf) carrier. The function of a radio or television receiver is simply to reproduce the modulating wave from the modulated carrier.

As shown in Fig. 14, a superheterodyne radio receiver picks up the transmitted modulated rf signal, amplifies it, converts it to a modulated intermediate-frequency (if) signal, amplifies the modulated if signal, separates the modulating signal from the basic carrier wave (Detection), and amplifies the

resulting audio signal to a level sufficient to produce the desired volume in a speaker. In addition, the receiver usually includes some means of producing automatic gain control (agc) of the modulated signal before the audio information is separated from the carrier.

The transmitted rf signal picked up by the radio receiver may contain either amplitude modulation (AM) or frequency modulation (FM). (These modulation techniques are described later in the section on **Detection**.) In either case, amplification prior to the detector stage is performed by tuned amplifier circuits designed for the proper frequency and bandwidth. Frequency conversion is performed by mixer and oscillator circuits or by a single converter stage which performs both mixer and oscillator functions. Separation of the modulating signal is normally accomplished by one or more diodes in a detector or discriminator circuit. Amplification of the audio signal is then performed by one or more audio amplifier stages.

Audio-amplifier systems for phonograph or tape recordings are similar to the stages after detection in a radio receiver. The input to the amplifier is a low-power-level audio signal from the

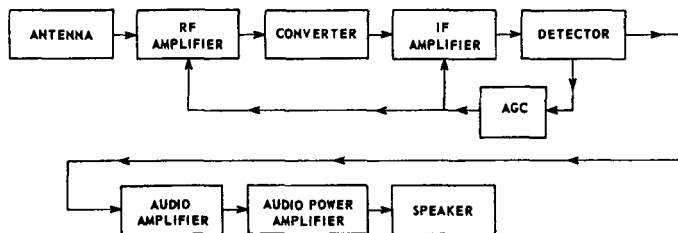

Fig. 14—Simplified block diagram for a broadcast-band receiver.

phonograph or magnetic-tape pickup head. This signal is usually amplified through a preamplifier stage, one or more low-level (pre-driver or driver) audio stages, and an audio power amplifier. The system may also include frequency-selective circuits which act as equalization networks and/or tone controls.

The operation of a television receiver is more complex than that of a radio receiver, as shown by the simplified block diagram in Fig. 15. The tuner section of the receiver selects the proper rf signals for the desired channel frequency, amplifies them, and converts them to a lower intermediate frequency.

formation to the television picture tube and thus controls instantaneous "spot" brightness. At the same time, deflection circuits cause the electron beam of the picture tube to move the "spot" across the faceplate horizontally and vertically. Special "sync" signals derived from the video signal assure that the horizontal and vertical scanning are timed so that the picture produced on the receiver exactly duplicates the picture being viewed by the camera or pickup tube.

A communications transceiver contains transmitting circuits, as well as receiving circuits similar to those of a radio receiver. The transmitter portion

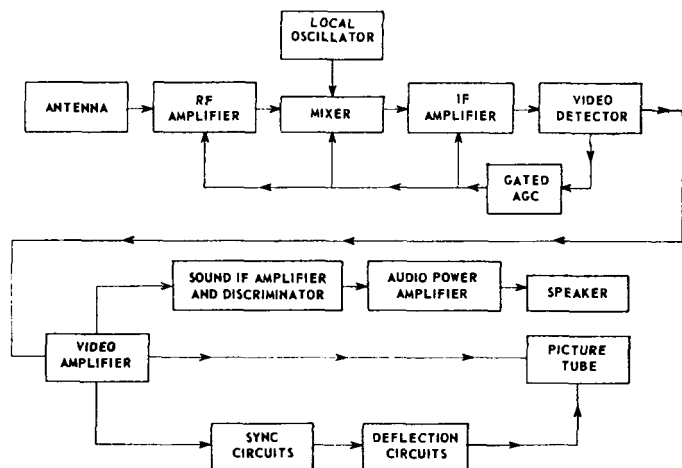

Fig. 15—Simplified block diagram for a black-and-white television receiver.

As in a radio receiver, these functions are accomplished in rf-amplifier, mixer, and local-oscillator stages. The if signal is then amplified in if-amplifier stages which provide the additional gain required to bring the signal level to an amplitude suitable for detection of the video information.

After detection, the video signal is amplified and separated into sound and picture information. The sound signal is amplified and processed to provide an audio signal which is fed to an audio amplifier system similar to those described above. The picture (video) signal is passed through a video amplifier stage which conveys beam-intensity in-

formation to the television picture tube and thus controls instantaneous "spot" brightness. At the same time, deflection circuits cause the electron beam of the picture tube to move the "spot" across the faceplate horizontally and vertically. Special "sync" signals derived from the video signal assure that the horizontal and vertical scanning are timed so that the picture produced on the receiver exactly duplicates the picture being viewed by the camera or pickup tube.

of such a system consists of two sections. In one section, the desired intelligence (voice, code, or the like) is picked up and amplified through one or more amplifier stages (which are usually common to the receiver portion) to a high-level stage called a modulator. In the other section, an rf signal of the desired frequency is developed in an oscillator stage and amplified in one or more rf-amplifier stages. The audio-frequency (af) modulating signal is impressed on the rf carrier in the final rf-power-amplifier stage (high-level modulation), in the rf low-level stage (low-level modulation), or in both. Fig. 16 shows a simplified block diagram of the trans-

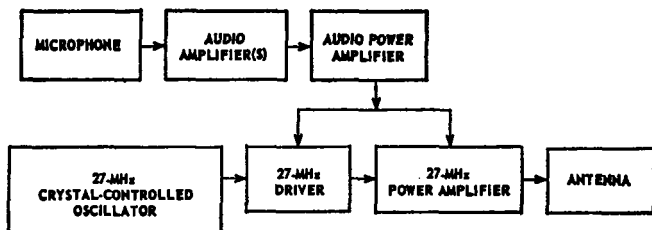

Fig. 16—Simplified block diagram for the transmitter portion of a 27-MHz communications receiver.

mitter portion of a citizens-band transmitter that operates at a frequency of 27 MHz (megacycles per second). The transmitting section of a communications system may also include frequency-multiplier circuits which raise the frequency of the developed rf signal as required.

Rectification

The rectifying action of a diode finds important applications in supplying a receiver with dc power from an ac line and in supplying high dc voltage from a high-voltage pulse. A typical arrangement for converting ac to dc includes a rectifier tube, a filter, and a voltage divider. The rectifying action of the tube is explained briefly under **Diodes**, in the **Electrons, Electrodes, and Electron Tubes** section. High-voltage pulse rectification is described later under **Horizontal Output Circuits**.

The function of a filter is to smooth out the ripple of the tube out-

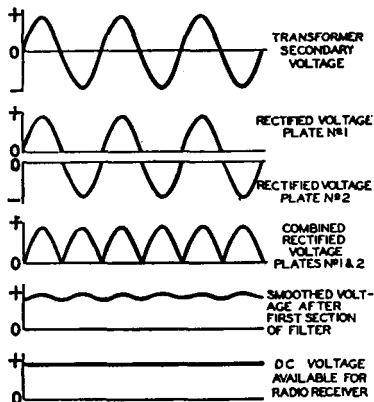

Fig. 17—Voltage waveforms of full-wave rectifier circuit.

put, as indicated in Fig. 17, and to increase rectifier efficiency. The action of the filter is explained in the **Electron Tube Installation** section under **Filters**. The voltage divider is used to cut down the output voltage to the values required by the plates and the other electrodes of the tubes in the receiver.

A **half-wave rectifier** and a **full-wave rectifier** circuit are shown in Fig. 18. In the half-wave circuit, current

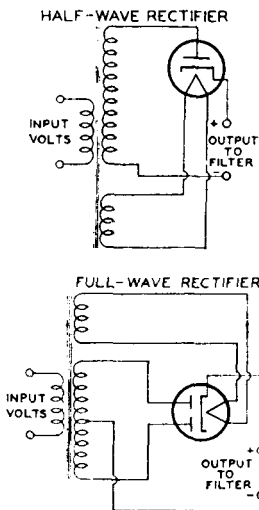

Fig. 18—Half-wave and full-wave rectifier circuits.

flows through the rectifier tube to the filter on every other half-cycle of the ac input voltage when the plate is positive with respect to the cathode. In the full-wave circuit, current flows to the filter on every half-cycle, through plate No. 1 on one half-cycle when plate No. 1 is positive with respect to the cathode, and through plate No. 2 on the next

half-cycle when plate No. 2 is positive with respect to the cathode.

Because the current flow to the filter is more uniform in the full-wave circuit than in the half-wave circuit, the output of the full-wave circuit requires less filtering. Rectifier operating information and circuits are given under each rectifier tube type and in the **Circuits** section, respectively.

Parallel operation of rectifier tubes furnishes an output current greater than that obtainable with the use of one tube. For example, when two full-wave rectifier tubes are connected in parallel, the plates of each tube are connected together and each tube acts as a half-wave rectifier. The permissible voltage and load conditions per tube are the same as for full-wave service but the total load-current-handling capability of the complete rectifier is approximately doubled.

When mercury-vapor rectifier tubes are connected in parallel, a stabilizing resistor of 50 to 100 ohms should be connected in series with each plate lead in order that each tube will carry an equal share of the load current. The value of the resistor to be used will depend on the amount of plate current that passes through the rectifier. Low plate current requires a high value; high plate current, a low value. When the plates of mercury-vapor rectifier tubes are connected in parallel, the corresponding filament leads should be similarly connected. Otherwise, the tube drops will be considerably unbalanced and larger stabilizing resistors will be required.

Two or more vacuum rectifier tubes can also be connected in parallel to give correspondingly higher output current and, as a result of paralleling their internal resistances, give somewhat increased voltage output. With vacuum types, stabilizing resistors may or may not be necessary depending on the tube type and the circuit.

A **voltage-doubler** circuit of simple form is shown in Fig. 19. The circuit derives its name from the fact that its dc voltage output can be as high as twice the peak value of ac input. Basically, a voltage doubler is a rectifier cir-

cuit arranged so that the output voltages of two half-wave rectifiers are in series.

The action of a voltage doubler can be described briefly as follows. On the positive half-cycle of the ac input, that is, when the upper side of the ac input line is positive with respect to the lower side, the upper diode passes current and feeds a positive charge into the upper capacitor. As positive charge accumulates on the upper plate of the capacitor, a positive voltage builds up across the capacitor. On the next half-cycle of the ac input, when the upper side of the line is negative with respect to the lower side, the lower diode passes current so that

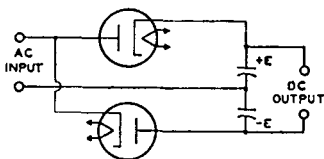

Fig. 19—Full-wave voltage-doubler circuit.

a negative voltage builds up across the lower capacitor.

So long as no current is drawn at the output terminals from the capacitor, each capacitor can charge up to a voltage of magnitude E , the peak value of the ac input. It can be seen from the diagram that with a voltage of $+E$ on one capacitor and $-E$ on the other, the total voltage across the capacitors is $2E$. Thus the voltage doubler supplies a no-load dc output voltage twice as large as the peak ac input voltage. When current is drawn at the output terminals by the load, the output voltage drops below $2E$ by an amount that depends on the magnitude of the load current and the capacitance of the capacitors. The arrangement shown in Fig. 19 is called a full-wave voltage doubler because each rectifier passes current to the load on each half of the ac input cycle.

A rectifier type especially designed for use as a voltage doubler is the 25Z6GT. This tube combines two separate diodes in one tube. As a voltage doubler, the tube is used in "transformerless" receivers. In these receivers, the heaters of all tubes in the set

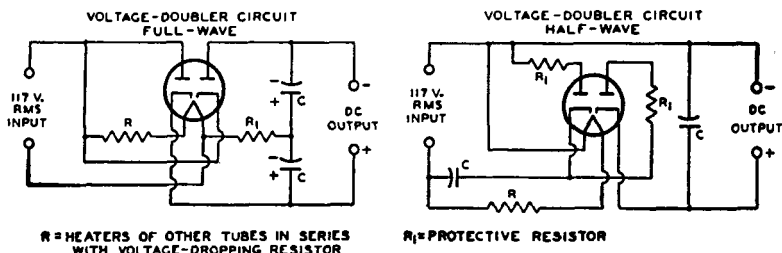

Fig. 20—Full-wave and half-wave voltage-doubler circuits showing heater-supply connections.

are connected in series with a voltage-dropping resistor across the line. The connections for the heater supply and the voltage-doubling circuit are shown in Fig. 20.

With the full-wave voltage-doubler circuit in Fig. 20, it will be noted that the dc load circuit cannot be connected to ground or to one side of the ac supply line. This circuit presents certain disadvantages when the heaters of all the tubes in the set are connected in series with a resistance across the ac line. Such a circuit arrangement may cause hum because of the high ac potential between the heaters and cathodes of the tubes.

The half-wave voltage-doubler circuit in Fig. 20 overcomes this difficulty by making one side of the ac line common with the negative side of the dc load circuit. In this circuit, one half of the tube is used to charge a capacitor which, on the following half cycle, discharges in series with the line voltage through the other half of the tube. This circuit is called a half-wave voltage doubler because rectified current flows to the load only on alternate halves of the ac input cycle. The voltage regulation of this arrangement is somewhat poorer than that of the full-wave voltage doubler.

Detection

When speech, music, or video information is transmitted from a radio or television station, the station radiates a radio-frequency (rf) wave which is of either of two general types. In one type, the wave is said to be amplitude modulated when its frequency remains constant and the amplitude is varied. In the other type, the wave is said to be frequency modulated when its amplitude remains essentially constant but its frequency is varied.

The function of the receiver is to reproduce the original modulating wave from the modulated rf wave. The receiver stage in which this function is performed is called the **demodulator** or **detector** stage.

AM Detection

The effect of **amplitude modulation** on the waveform of the rf wave is shown in Fig. 21. There are three different basic circuits used for the detection of amplitude-modulated waves: the diode detector, the grid-bias detector, and the grid-resistor detector. These circuits are alike in that they eliminate, either partially or completely, alternate half-cycles of the rf wave. With alternate half-cycles removed, the audio variations of the other half-cycles can be

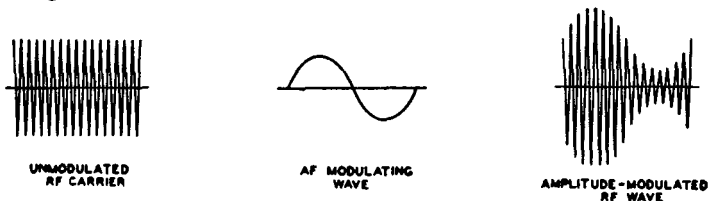

Fig. 21—Waveforms showing effect of amplitude modulation on an rf wave.

amplified to drive headphones or a loud-speaker.

A diode-detector circuit is shown in Fig. 22. The action of this circuit when a modulated rf wave is applied is

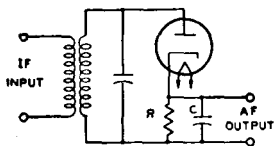

Fig. 22—Basic diode-detector circuit.

illustrated by Fig. 23. The rf voltage applied to the circuit is shown in light line; the output voltage across capacitor C is shown in heavy line.

Between points (a) and (b) on the first positive half-cycle of the applied rf voltage, capacitor C charges up to the peak value of the rf voltage. Then as the applied rf voltage falls away from its peak value, the capacitor holds the cathode at a potential more positive than the voltage applied to the anode.

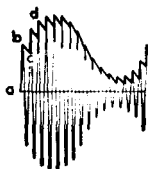

Fig. 23—Waveforms showing modulated rf input (light line) and output voltage (heavy line) of diode-detector circuit.

The capacitor thus temporarily cuts off current through the diode. While the diode current is cut off, the capacitor discharges from (b) to (c) through the diode load resistor R.

When the rf voltage on the anode rises high enough to exceed the potential at which the capacitor holds the cathode, current flows again and the capacitor charges up to the peak value of the second positive half-cycle at (d). In this way, the voltage across the capacitor follows the peak value of the applied rf voltage and reproduces the af modulation.

The curve for voltage across the capacitor, as shown in Fig. 23, is somewhat jagged. However, this jaggedness, which represents an rf component in the voltage across the capacitor, is

exaggerated in the drawing. In an actual circuit the rf component of the voltage across the capacitor is negligible. Hence, when the voltage across the capacitor is amplified, the output of the amplifier reproduces the speech or music originating at the transmitting station.

Another way to describe the action of a diode detector is to consider the circuit as a half-wave rectifier. When the rf signal on the plate swings positive, the tube conducts and the rectified current flows through the load resistance R. Because the dc output voltage of a rectifier depends on the voltage of the ac input, the dc voltage across C varies in accordance with the amplitude of the rf carrier and thus reproduces the af signal. Capacitor C should be large enough to smooth out rf or if variations, but should not be so large as to affect the audio variations. Two diodes can be connected in a circuit similar to a full-wave rectifier to provide full-wave detection. However, in practice, the advantages of this connection generally do not justify the extra circuit complication.

The diode method of detection produces less distortion than other methods because the dynamic characteristics of a diode can be made more linear than those of other detectors. The disadvantages of a diode are that it does not amplify the signal, and that it draws current from the input circuit and therefore reduces the selectivity of the input circuit. However, because the diode method of detection produces less distortion and because it permits the use of simple avc circuits without the necessity for an additional voltage supply, the diode method of detection is most widely used in broadcast receivers.

A typical diode-detector circuit using a diode—triode tube is shown in Fig. 24. R_1 is the diode load resistor. A portion of the af voltage developed across this resistor is applied to the triode grid through the volume control R_3 . In a typical circuit, resistor R_1 may be tapped so that five-sixths of the total af voltage across R_1 is applied to the volume control. This tapped connection reduces the af voltage output of the detector circuit slightly, but it

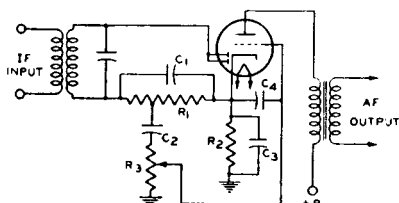

Fig. 24—Typical diode-detector circuit using a twin diode-triode tube.

reduces audio distortion and improves the rf filtering.

DC bias for the triode section is provided by the cathode-bias resistor R_2 and the audio bypass capacitor C_3 . The function of capacitor C_2 is to block the dc bias of the cathode from the grid. The function of capacitor C_4 is to bypass any rf voltage on the grid to cathode. A diode-pentode may also be used in this circuit. With a pentode, the af output should be resistance-coupled rather than transformer-coupled.

Another diode-detector circuit, called a diode-biased circuit, is shown in Fig. 25. In this circuit, the triode grid

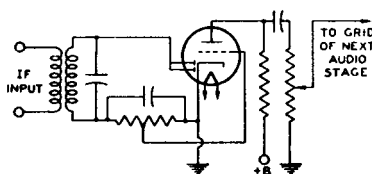

Fig. 25—Diode-biased detector circuit.

is connected directly to a tap on the diode load resistor. When an rf signal voltage is applied to the diode, the dc voltage at the tap supplies bias to the triode grid. When the rf signal is modulated, the af voltage at the tap is applied to the grid and is amplified by the triode.

The advantage of the circuit shown in Fig. 25 over the self-biased arrangement shown in Fig. 24 is that the diode-biased circuit does not employ a capacitor between the grid and the diode load resistor, and consequently does not produce as much distortion of a signal having a high percentage of modulation.

However, there are restrictions on the use of the diode-biased circuit. Be-

cause the bias voltage on the triode depends on the average amplitude of the rf voltage applied to the diode, the average amplitude of the voltage applied to the diode should be constant for all values of signal strength at the antenna. Otherwise there will be different values of bias on the triode grid for different signal strengths and the triode will produce distortion. Because there is no bias applied to the diode-biased triode when no rf voltage is applied to the diode, sufficient resistance should be included in the plate circuit of the triode to limit its zero-bias plate current to a safe value.

These restrictions mean, in practice, that the receiver should have a separate-channel automatic-volume-control (avc) system. With such an avc system, the average amplitude of the signal voltage applied to the diode can be held within very close limits for all values of signal strength at the antenna.

The tube used in a diode-biased circuit should be one which operates at a fairly large value of bias voltage. The variations in bias voltage are then a small percentage of the total bias and hence produce small distortion. Tubes taking a fairly large bias voltage are types such as the 6BF6 or 6SR7 having a medium- μ triode. Tube types having a high- μ triode or a pentode should not be used in a diode-biased circuit.

A **grid-bias detector** circuit is shown in Fig. 26. In this circuit, the grid is biased almost to cutoff, *i.e.*, operated so that the plate current with zero signal is practically zero. The bias voltage can be obtained from a cathode-bias resistor, a C-battery, or a bleeder tap. Because of the high negative bias, only the positive half-cycles of the rf signal are amplified by the tube. The signal is, therefore, detected in the

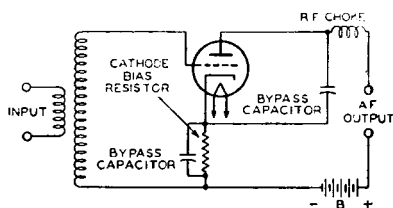

Fig. 26—Grid-bias detector circuit.

plate circuit. The advantages of this method of detection are that it amplifies the signal, besides detecting it, and that it does not draw current from the input circuit and therefore does not reduce the selectivity of the input circuit.

The **grid-resistor-and-capacitor method**, illustrated in Fig. 27, is somewhat more sensitive than the grid-bias method and gives its best results on weak signals. In this circuit, there is no negative dc bias voltage applied to the grid. Hence, on the positive half-cycles of the rf signal, current flows from grid to cathode. The grid and cathode thus act as a diode detector, with the grid resistor as the diode load resistor and the grid capacitor as the rf bypass capacitor. The voltage across the capacitor then reproduces the af modulation in the same manner as has been explained for the diode detector. This voltage appears between the grid and cathode and is therefore amplified in

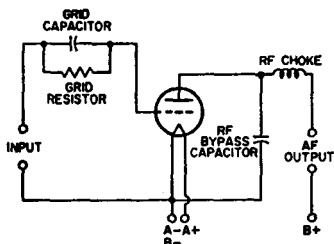

Fig. 27—Detector circuit using grid-resistor-and-capacitor bias.

the plate circuit. The output voltage thus reproduces the original af signal.

In this detector circuit, the use of a high-resistance grid resistor increases selectivity and sensitivity. However, improved af response and stability are obtained with lower values of grid-circuit resistance. This detector circuit amplifies the signal, but draws current from the input circuit and therefore reduces the selectivity of the input circuit.

FM Detection

The effect of **frequency modulation** on the waveform of the rf wave is shown in Fig. 28. In this type of transmission, the frequency of the rf wave deviates from a mean value, at an audio-frequency rate depending on the modu-

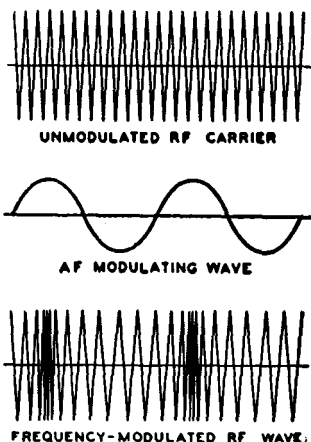

Fig. 28—Waveforms showing effect of frequency modulation on an rf wave.

lation, by an amount that is determined in the transmitter and is proportional to the amplitude of the af modulation signal.

For this type of modulation, a detector is required to discriminate between deviations above and below the mean frequency and to translate those deviations into a voltage whose amplitude varies at audio frequencies. Since the deviations occur at an audio frequency, the process is one of demodulation, and the degree of frequency deviation determines the amplitude of the demodulated (af) voltage.

A simple circuit for converting frequency variations to amplitude variations is a circuit which is tuned so that the mean radio frequency is on one slope of its resonance characteristic, as at A of Fig. 29. With modulation, the

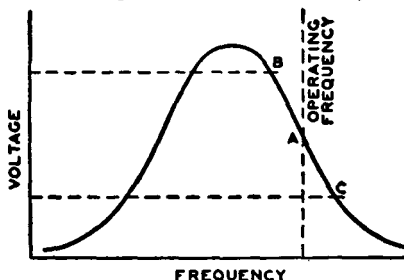

Fig. 29—Resonance curve of a tuned circuit showing desired operating range for frequency-modulation converter.

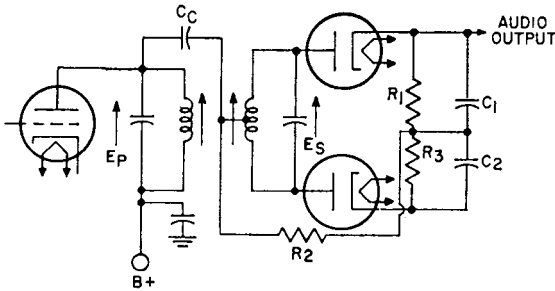

Fig. 30—Balanced phase-shift discriminator circuit.

frequency swings between B and C, and the voltage developed across the circuit varies at the modulating rate. In order that no distortion will be introduced in this circuit, the frequency swing must be restricted to the portion of the slope which is effectively straight. Since this portion is very short, the voltage developed is low. Because of these limitations, this circuit is not commonly used but it serves to illustrate the principle.

The faults of the simple circuit are overcome in a push-pull arrangement, such as that shown in Fig. 30, called a **balanced phase-shift discriminator**. In this detector, the mutually coupled tuned circuits in the primary and secondary windings of the transformer T are tuned to the center frequency. A characteristic of a double-tuned transformer is that the voltages in the primary and secondary windings are 90 degrees out of phase at resonance, and that the phase shift changes as the frequency changes from resonance. Therefore, the signal applied to the diodes and the RC combinations for peak detection also changes with frequency.

Because the secondary winding of the transformer T is center-tapped, the applied primary voltage E_p is added to one-half the secondary voltage E_s , through the capacitor C_c . The addition of these voltages at resonance can be represented by the diagram in Fig. 31(a); the resultant voltage E_r is the signal applied to one peak-detector network consisting of one diode and its RC load. When the signal frequency decreases (from resonance), the phase shift of $E_s/2$ becomes greater than 90 degrees, as shown at (b) in Fig. 31, and E_r becomes smaller. When the signal fre-

quency increases (above resonance), the phase shift of $E_s/2$ is less than 90 degrees as shown at (c), and E_r becomes

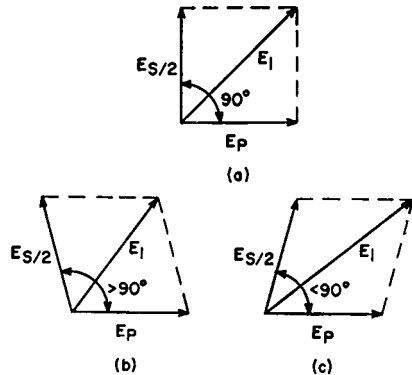

Fig. 31—Diagram illustrating phase shift in double-tuned transformer (a) at resonance, (b) below resonance, and (c) above resonance.

larger. The curve of E_r as a function of frequency in Fig. 32 is readily identified as the response curve of an FM detector.

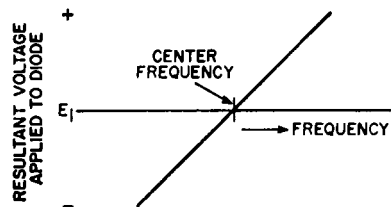

Fig. 32—Diagram showing resultant voltage E_r in Fig. 31 as a function of frequency.

Because the discriminator circuit shown in Fig. 30 uses a push-pull configuration, the diodes conduct on alternate half-cycles of the signal frequency and produce a plus-and-minus output with respect to zero rather than with

respect to E_1 . The primary advantage of this arrangement is that there is no output at resonance. When an FM signal is applied to the input, the audio output voltage varies above and below zero as the instantaneous frequency varies above and below resonance. The frequency of this audio voltage is determined by the modulation frequency of the FM signal, and the amplitude of the voltage is proportional to the frequency excursion from resonance. (The resistor R_2 in the circuit provides a dc return for the diodes, and also maintains a load impedance across the primary winding of the transformer.)

One disadvantage of the balanced phase-shift discriminator shown in Fig. 30 is that it detects audio modulation (AM) as well as frequency modulation (FM) in the if signal because the circuit is balanced only at the center frequency. At frequencies off resonance, any variation in amplitude of the if signal is reproduced to some extent in the audio output.

The **ratio-detector** circuit shown in Fig. 33 is a discriminator circuit which has the advantage of being relatively

placed "back-to-back" (in series, rather than in push-pull) so that both halves of the circuit operate simultaneously during one-half of the signal frequency cycle (and are cut off on the other half-cycle). As a result, the detected voltages E_1 and E_2 are in series, as shown for the instantaneous polarities that occur during the conduction half-cycle. When the audio output is taken between the equal capacitors C_1 and C_2 , therefore, the output voltage is equal to $(E_2 - E_1)/2$ (for equal resistors R_1 and R_2).

The dc circuit of the ratio detector consists of a path through the secondary winding of the transformer, both diodes (which are in series), and resistors R_1 and R_2 . The value of the electrolytic capacitor C_3 is selected so that the time constant of R_1 , R_2 , and C_3 is very long compared to the detected audio signal. As a result, the sum of the detected voltages ($E_1 + E_2$) is a constant and the AM components on the signal frequency are suppressed. This feature of the ratio detector provides improved AM rejection as compared to the phase-shift discriminator circuit shown in Fig. 30.

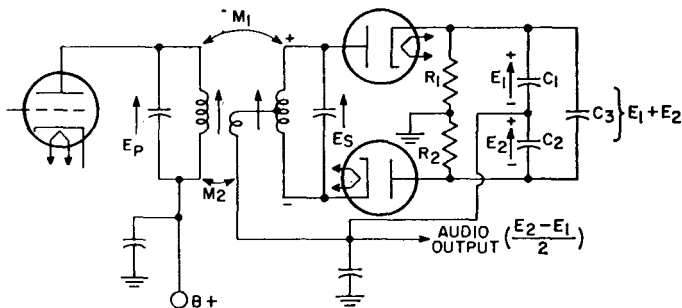

Fig. 33—Ratio-detector circuit.

insensitive to amplitude variations in the FM signal. In this circuit, E_p is added to $E_s/2$ through the mutual coupling M_2 (this voltage addition may be made by either mutual or capacitive coupling). Because of the phase-shift relationship of these voltages, the resultant detected signals vary with frequency variations in the same manner as described for the phase-shift discriminator circuit shown in Fig. 30. However, the diodes in the ratio detector are

Amplification

The amplifying action of an electron tube was mentioned under **Triodes** in the section on **Electrons, Electrodes, and Electron Tubes**. This action can be utilized in electronic circuits in a number of ways, depending upon the results desired. Four classes of amplifier service recognized by engineers are covered by definitions standardized by the Institute of Electrical and

Electronics Engineers. This classification depends primarily on the fraction of input cycle during which plate current is expected to flow under rated full-load conditions. The classes are class A, class AB, class B, and class C. The term "cutoff bias" used in these definitions is the value of grid bias at which plate current is very small (i.e., approaches zero).

Classes of Service

A **class A amplifier** is an amplifier in which the grid bias and alternating grid voltages are such that plate current in a specific tube flows at all times.

A **class AB amplifier** is an amplifier in which the grid bias and alternating grid voltages are such that plate current in a specific tube flows for appreciably more than half but less than the entire electrical cycle.

A **class B amplifier** is an amplifier in which the grid bias is approximately equal to the cutoff value, so that the plate current is approximately zero when no exciting grid voltage is applied, and so that plate current in a specific tube flows for approximately one-half of each cycle when an alternating grid voltage is applied.

A **class C amplifier** is an amplifier in which the grid bias is appreciably greater than the cutoff value, so that the plate current in each tube is zero when no alternating grid voltage is applied, and so that plate current flows in a specific tube for appreciably less than one-half of each cycle when an alternating grid voltage is applied.

The suffix 1 may be added to the letter or letters of the class identification to denote that grid current does not flow during any part of the input cycle. The suffix 2 may be used to denote that grid current flows during part of the cycle.

For radio-frequency (rf) amplifiers which operate into a selective tuned circuit, as in radio transmitter applications, or under requirements where distortion is not an important factor, any of the above classes of amplifiers may be used, either with a single tube or with a push-pull stage. For audio-frequency (af) amplifiers in which dis-

tortion is an important factor, only class A amplifiers permit single-tube operation. In this case, operating conditions are usually chosen so that distortion is kept below the conventional 5 per cent for triodes and the conventional 7 to 10 per cent for tetrodes or pentodes. Distortion can be reduced below these figures by means of special circuit arrangements such as that discussed under **inverse feedback**. With class A amplifiers, reduced distortion with improved power performance can be obtained by using a push-pull stage for audio service. With class AB and class B amplifiers, a balanced stage using two tubes is required for audio service.

Class A Voltage Amplifiers

As a class A voltage amplifier, an electron tube is used to reproduce grid-voltage variations across an impedance or a resistance in the plate circuit. These variations are essentially of the same form as the input signal voltage impressed on the grid, but their amplitude is increased. This increase is accomplished by operation of the tube at a suitable grid bias so that the applied grid input voltage produces plate-current variations proportional to the signal swings. Because the voltage variation obtained in the plate circuit is much larger than that required to swing the grid, amplification of the signal is obtained.

Fig. 34 gives a graphical illustration of this method of amplification and shows, by means of the grid-voltage vs. plate-current characteristics curve, the effect of an input signal (S) applied to

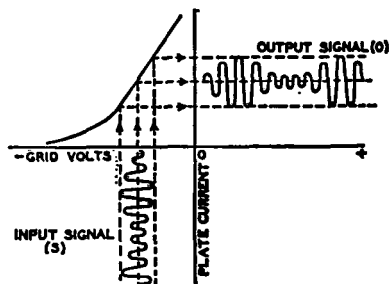

Fig. 34—Current characteristics of class A amplifier.

the grid of a tube. The output signal (O) is the resulting amplified plate-current variation.

The plate current flowing through the load resistance (R) of Fig. 35 causes a voltage drop which varies directly with the plate current. The ratio of this voltage variation produced in the load resistance to the input signal volt-

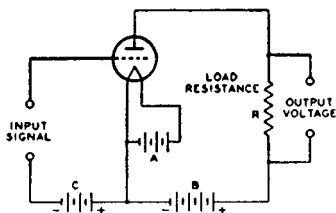

Fig. 35—Triode amplifier circuit.

age is the voltage amplification, or *gain*, provided by the tube. The voltage amplification due to the tube is expressed by the following convenient formulas:

$$\text{Voltage amplification} = \frac{\mu \times R_L}{R_L + r_p}$$

$$\text{or } \frac{g_m \times r_p \times R_L}{1000000 \times (r_p + R_L)}$$

where μ is the amplification factor of the tube, R_L is the load resistance in ohms, r_p is the plate resistance in ohms, and g_m is the transconductance in micromhos.

From the first formula, it can be seen that the gain actually obtainable from the tube is less than the tube amplification factor, but that the gain approaches the amplification factor when the load resistance is large compared to the tube plate resistance. Fig. 36 shows graphically how the gain approaches the amplification factor of the tube as the load resistance is increased.

From the curve it can be seen that a high value of load resistance should be used to obtain high gain in a voltage amplifier.

In a **resistance-coupled amplifier**, the load resistance of the tube is approximately equal to the resistance of the plate resistor in parallel with the grid resistor of the following stage. Hence, to obtain a large value of load resistance, it is necessary to use a plate resistor and a grid resistor of large resistance. However, the plate resistor should not be too large because the flow of plate current through the plate resistor produces a voltage drop which reduces the plate voltage applied to the tube. If the plate resistor is too large, this drop will be too large, the plate voltage on the tube will be too small, and the voltage output of the tube will be too small. Also, the grid resistor of the following stage should not be too large, the actual maximum value being dependent on the particular tube type. This precaution is necessary because all tubes contain minute amounts of residual gas which cause a minute flow of current through the grid resistor. If the grid resistor is too large, the positive bias developed by the flow of this current through the resistor decreases the normal negative bias and produces an increase in the plate current. This increased current may overheat the tube and cause liberation of more gas which, in turn, will cause further decrease in bias. The action is cumulative and results in a runaway condition which can destroy the tube.

A higher value of grid resistance is permissible when cathode-resistor bias is used than when fixed bias is used.

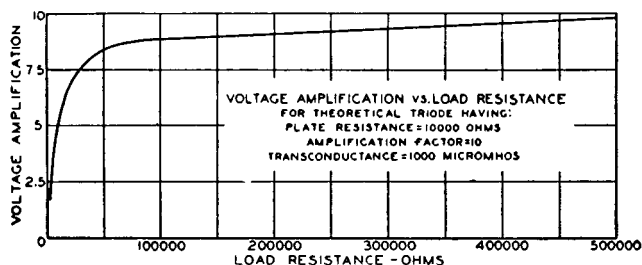

Fig. 36—Gain curve for triode amplifier circuit.

When cathode-resistor bias is used, a loss in bias due to gas or grid-emission effects is almost completely offset by an increase in bias due to the voltage drop across the cathode resistor. Typical values of plate resistor and grid resistor for tube types used in resistance-coupled circuits, and the values of gain obtainable, are shown in the **Resistance-Coupled Amplifier** section.

The **input impedance** of an electron tube (that is, the impedance between grid and cathode) consists of (1) a reactive component due to the capacitance between grid and cathode, (2) a resistive component resulting from the time of transit of electrons between cathode and grid, and (3) a resistive component developed by the part of the cathode lead inductance which is common to both the input and output circuits. These components are dependent on the frequency of the incoming signal. The input impedance is very high at audio frequencies when a tube is operated with its grid biased negative. In a class A_1 or AB_1 transformer-coupled audio amplifier, therefore, the loading imposed by the grid on the input transformer is negligible. As a result, the secondary impedance of a class A_1 or class AB_1 input transformer can be made very high because the choice is not limited by the input impedance of the tube; however, transformer design considerations may limit the choice.

At the high radio frequencies, the input impedance may become very low even when the grid is negative, due to the finite time of passage of electrons between cathode and grid and to the appreciable lead reactance. This impedance drops very rapidly as the frequency is raised, and increases input-circuit loading. In fact, the input impedance may become low enough at very high radio frequencies to affect the gain and selectivity of a preceding stage appreciably. Tubes such as the "acorn" and "pencil" types and the high-frequency miniatures have been developed to have low input capacitances, low electron-transit time, and low lead inductance so that their input impedance is high even at the ultra-

high radio frequencies. **Input admittance** is the reciprocal of input impedance.

A **remote-cutoff amplifier** tube is a modified construction of a pentode or a tetrode type designed to reduce modulation-distortion and cross-modulation in radio-frequency stages. **Cross-modulation** is the effect produced in a radio or television receiver by an interfering station "riding through" on the carrier of the station to which the receiver is tuned. **Modulation-distortion** is a distortion of the modulated carrier and appears as audio-frequency distortion in the output. This effect is produced by a radio-frequency amplifier stage operating on an excessively curved characteristic when the grid bias has been increased to reduce volume. The offending stage for cross-modulation is usually the first radio-frequency amplifier, while for modulation-distortion the cause is usually the last intermediate-frequency stage. The characteristics of remote-cutoff types are such as to enable them to handle both large and small input signals with minimum distortion over a wide range of signal strength.

Fig. 37 illustrates the construction of the grid No. 1 (control grid) in a remote-cutoff tube. The remote-cutoff

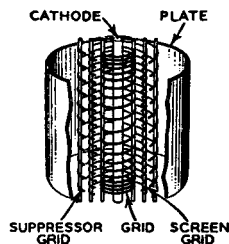

Fig. 37—Structure of remote-cutoff grid.

action is due to the structure of the grid which provides a variation in amplification factor with change in grid bias. The grid No. 1 is wound with open spacing at the middle and with close spacing at the ends. When weak signals and low grid bias are applied to the tube, the effect of the non-uniform turn spacing of the grid on cathode emission and tube characteristics is essentially the same as for uniform spacing. As the

grid bias is made more negative to handle larger input signals, the electron flow from the sections of the cathode enclosed by the ends of the grid is cut off. The plate current and other tube characteristics are then dependent on the electron flow through the open section of the grid. This action changes the gain of the tube so that large signals may be handled with minimum distortion due to cross-modulation and modulation-distortion.

Fig. 38 shows a typical plate-current vs. grid-voltage curve for a remote-cutoff type compared with the curve

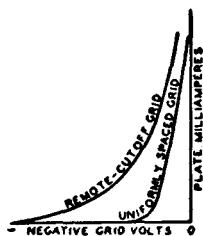

Fig. 38—Plate-current curves for triodes having remote-cutoff and uniformly spaced grids.

for a type having a uniformly spaced grid. It will be noted that while the curves are similar at small grid-bias voltages, the plate current of the remote-cutoff tube drops quite slowly with large values of bias voltage. This slow change makes it possible for the tube to handle large signals satisfactorily. Because remote-cutoff types can accommodate large and small signals, they are particularly suitable for use in sets having automatic volume control. Remote-cutoff tubes also are known as **variable-mu** types.

Class A Power Amplifiers

As a class A power amplifier, an electron tube is used in the output stage of a radio or television receiver to supply a relatively large amount of power to the loudspeaker. For this application, large power output is of more importance than high voltage amplification; therefore, gain possibilities are sacrificed in the design of power tubes to obtain power-handling capability.

Triodes, pentodes, and beam power

tubes designed for power amplifier service have certain inherent features for each structure. Power tubes of the triode type for class A service are characterized by low power sensitivity, low plate-power efficiency, and low distortion. Power tubes of the pentode type are characterized by high power sensitivity, high plate-power efficiency and, usually, somewhat higher distortion than class A triodes. Beam power tubes have higher power sensitivity and efficiency than triode or conventional pentode types.

A class A power amplifier is also used as a driver to supply power to a class AB₂ or a class B stage. It is usually advisable to use a triode, rather than a pentode, in a driver stage because of the lower plate impedance of the triode.

Power tubes connected in either **parallel** or **push-pull** may be employed as class A amplifiers to obtain increased output. The parallel connection (Fig. 39) provides twice the output of a single tube with the same value of grid-signal voltage. With this connection, the effective transconductance of the stage is doubled, and the effective plate

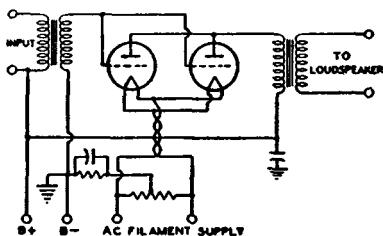

Fig. 39—Power amplifier with tubes connected in parallel.

resistance and the load resistance required are halved as compared with single-tube values.

The push-pull connection (Fig. 40), although it requires twice the grid-signal voltage, provides increased power and has other important advantages over single-tube operation. Distortion caused by even-order harmonics and hum caused by plate-voltage-supply fluctuations are either eliminated or decidedly reduced through cancellation.

Because distortion for push-pull operation is less than for single-tube operation, appreciably more than twice single-tube output can be obtained with triodes by decreasing the load resistance for the stage to a value approaching the load resistance for a single tube.

For either parallel or push-pull class A operation of two tubes, all electrode currents are doubled while all dc electrode voltages remain the same as for single-tube operation. If a cathode resistor is used, its value should be about one-half that for a single tube.

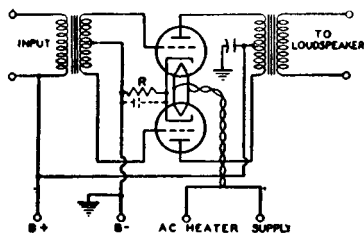

Fig. 40—Power amplifier with tubes connected in push-pull.

If oscillations occur with either type of connection, they can often be eliminated by the use of a non-inductive resistor of approximately 100 ohms connected in series with each grid at the socket terminal.

Operation of power tubes so that the grids run positive is inadvisable except under conditions such as those discussed in this section for class AB and class B amplifiers.

Power-Output Calculations

Calculation of the power output of a triode used as a class A amplifier with either an output transformer or a choke having low dc resistance can be made

without serious error from the plate family of curves by assuming a resistance load. The proper plate current, grid bias, optimum load resistance, and per-cent second-harmonic distortion can also be determined. The calculations are made graphically and are illustrated in Fig. 41 for given conditions. The procedure is as follows:

(1) Locate the zero-signal bias point P by determining the zero-signal bias E_c from the formula:

$$\text{Zero-signal bias } (E_{c0}) = -(0.68 \times E_b) / \mu$$

where E_b is the chosen value in volts of dc plate voltage at which the tube is to be operated, and μ is the amplification factor of the tube. This quantity is shown as negative to indicate that a negative bias is used.

(2) Locate the value of zero-signal plate current, I_0 , corresponding to point P.

(3) Locate the point $2I_0$, which is twice the value of I_0 and corresponds to the value of the maximum-signal plate current I_{\max} .

(4) Locate the point X on the dc bias curve at zero volts, $E_c = 0$, corresponding to the value of I_{\max} .

(5) Draw a straight line XY through X and P.

Line XY is known as the load resistance line. Its slope corresponds to the value of the load resistance. The load resistance in ohms is equal to $(E_{\max} - E_{\min})$ divided by $(I_{\max} - I_{\min})$, where E is in volts and I is in amperes.

It should be noted that in the case of filament types of tubes, the calculations are given on the basis of a dc-operated filament. When the filament is ac-operated, the calculated value of dc

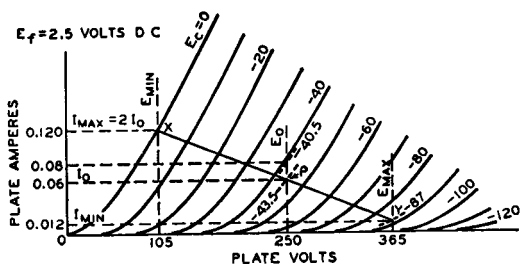

Fig. 41—Graphic calculations for class A amplifier using a power triode.

bias should be increased by approximately one-half the filament voltage rating of the tube.

The value of zero-signal plate current I_0 should be used to determine the plate dissipation, an important factor influencing tube life. In a class A amplifier under zero-signal conditions, the plate dissipation is equal to the power input, *i.e.*, the product of the dc plate voltage E_0 and the zero-signal dc plate current I_0 . If it is found that the plate-dissipation rating of the tube is exceeded with the zero-signal bias E_0 calculated above, it will be necessary to increase the bias by a sufficient amount so that the actual plate dissipation does not exceed the rating before proceeding further with the remaining calculations.

For power-output calculations, it is assumed that the peak alternating grid voltage is sufficient (1) to swing the grid from the zero-signal bias value E_0 to zero bias ($E_g = 0$) on the positive swing and (2) to swing the grid to a value twice the zero-signal bias value on the negative swing. During the negative swing, the plate voltage and plate current reach values of E_{max} and I_{min} ; during the positive swing, they reach values of E_{min} and I_{max} . Because power is the product of voltage and current, the power output P_0 as shown by a watt-meter is given by

$$P_0 = \frac{(I_{max} - I_{min}) \times (E_{max} - E_{min})}{8}$$

where E is in volts, I is in amperes, and P_0 is in watts.

In the output of power-amplifier triodes, some distortion is present. This distortion is due predominantly to second harmonics in single-tube amplifiers. The percentage of second-harmonic distortion may be calculated by the following formula:

$$\% \text{ distortion} = \frac{I_{max} + I_{min} - I_0}{I_{max} - I_{min}} \times 100$$

where I_0 is the zero-signal plate current in amperes. If the distortion is excessive, the load resistance should be increased or, occasionally, decreased slightly and the calculations repeated.

Example: Determine the load resistance, power output, and distortion

of a triode having an amplification factor of 4.2, a plate-dissipation rating of 15 watts, and plate-characteristics curves as shown in Fig. 41. The tube is to be operated at 250 volts on the plate.

Procedure: For a first approximation, determine the operating point P from the zero-signal bias formula, $E_0 = -(0.68 \times 250) / 4.2 = -40.5$ volts. From the curve for this voltage, it is found that the zero-signal plate current is 0.08 ampere and, therefore, the plate-dissipation rating is exceeded ($0.08 \times 250 = 20$ watts). Consequently, it is necessary to reduce the zero-signal plate current to 0.06 ampere at 250 volts. The grid bias is then -43.5 volts. Note that the curve was taken with a dc filament supply; if the filament is to be operated on an ac supply, the bias must be increased by about one-half the filament voltage, or to -45 volts, and the circuit returns made to the mid-point of the filament circuit.

Point X can then be determined. Point X is at the intersection of the dc bias curve at zero volts with I_{max} , where $I_{max} = 2I_0 = 2 \times 0.06 = 0.12$ ampere. Line XY is drawn through points P and X . E_{max} , E_{min} , and I_{min} are then found from the curves. When these values are substituted in the power-output formula, the following result is obtained:

$$P_0 = \frac{(0.12 - 0.012) \times (365 - 105)}{8} = 3.52 \text{ watts}$$

The resistance represented by load line XY is

$$\frac{(365 - 105)}{(0.12 - 0.012)} = 2410 \text{ ohms}$$

When the values from the curves are substituted in the distortion formula, the following result is obtained:

$$\% \text{ distortion} = \frac{0.12 + 0.012 - 0.06}{0.12 - 0.012} \times 100 = 5.5\%$$

It is customary to select the load resistance so that the distortion does not exceed five per cent. When the method shown is used to determine the slope of the load-resistance line, the second-harmonic distortion generally does not exceed five per cent. In the example, however, the distortion is excessive and it is desirable, therefore, to use a slightly higher load resistance. A load resistance

of 2500 ohms will provide a distortion of about 4.9 per cent. The power output is reduced only slightly to 3.5 watts.

Operating conditions for **triodes in push-pull** depend on the type of operation desired. Under class A conditions, distortion, power output, and efficiency are all relatively low. The operating bias can be anywhere between that specified for single-tube operation and that equal to one-half the grid-bias voltage required to produce plate-current cutoff at a plate voltage of $1.4E_o$, where E_o is the operating plate voltage. Higher bias than this value requires higher grid-signal voltage and results in class AB₁ operation, which is discussed later.

The method for calculating maximum power output for **triodes in push-pull class A operation** is as follows: Erect a vertical line at $0.6 E_o$ (see Fig. 42), intersecting the $E_c = 0$ curve at the point I_{max} . Then, I_{max} is determined from the curve for use in the formula

$$P_o = (I_{max} \times E_o)/5$$

If I_{max} is expressed in amperes and E_o in volts, power output is in watts.

Example: Assume that the plate voltage (E_o) is to be 300 volts, and the plate-dissipation rating of the tube is 15 watts. Then, for class A operation, the operating bias can be equal to, but not more than, one-half the grid bias for cutoff with a plate voltage of $1.4 \times 300 = 420$ volts. (Since cutoff bias is approximately -115 volts at a plate voltage of 420 volts, one-half of this value is -57.5 volts bias.) At this bias, the plate current is found from the plate family to be 0.054 ampere and, therefore, the plate dissipation is 0.054×300 or 16.2 watts. Since -57.5 volts is the limit of bias for class A operation of these tubes at a plate voltage of 300 volts, the dissipation cannot be reduced by increasing the bias and it becomes necessary to reduce the plate voltage.

If the plate voltage is reduced to 250 volts, the bias will be found to be -43.5 volts. For this value, the plate current is 0.06 ampere, and the plate dissipation is 15 watts. Then, following the method for calculating power output, erect a vertical line at $0.6E_o = 150$

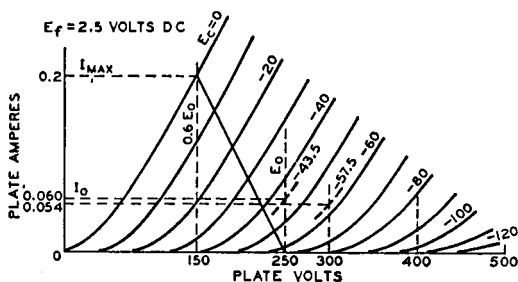

Fig. 42—Graphic calculations for push-pull class A amplifier using a power triode.

The method for determining the proper load resistance for triodes in push-pull is as follows: Draw a load line through I_{max} on the zero-bias curve and through the E_o point on the zero-current axis. Four times the resistance represented by this load line is the plate-to-plate load (R_{pp}) for two triodes in a class A push-pull amplifier. Expressed as a formula,

$$R_{pp} = 4 \times (E_o - 0.6E_o)/I_{max}$$

where E_o is expressed in volts, I_{max} in amperes, and R_{pp} in ohms.

The intersection of the line with the curve $E_c = 0$ is I_{max} or 0.2 ampere. When this value is substituted in the power formula, the power output is $(0.2 \times 250)/5 = 10$ watts. The load resistance is determined from the load formula: Plate-to-plate load (R_{pp}) = $4 \times (250 - 150)/0.2 = 2000$ ohms.

Power output for a pentode or a beam power tube as a class A amplifier can be calculated in much the same way as for triodes. Calculations can be made graphically from a special plate family of curves, as shown in Fig. 43.

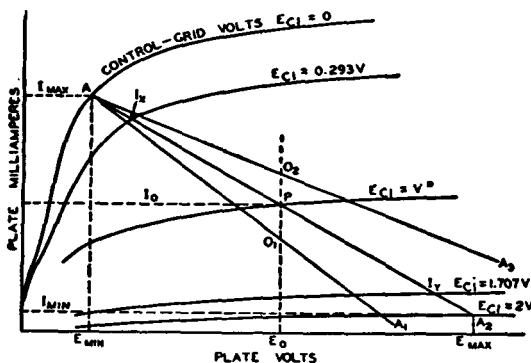

Fig. 43—Graphic calculations for class A amplifier using a pentode or beam power tube.

From a point A at or just below the knee of the zero-bias curve, draw arbitrarily selected load lines to intersect the zero-plate-current axis. These lines should be on both sides of the operating point P, whose position is determined by the desired operating voltage, E_0 , and one-half the maximum-signal plate current. Along any load line, say AA_1 , measure the distance AO_1 . On the same line, lay off an equal distance, O_1A_1 . For optimum operation, the change in bias from A to O_1 should be nearly equal to the change in bias from O_1 to A_1 . If this condition can not be met with one line, as is the case for the line first chosen, then another should be chosen. When the most satisfactory line has been selected, its resistance may be determined by the following formula:

$$\text{Load resistance (R}_L) = \frac{E_{\text{max}} - E_{\text{min}}}{I_{\text{max}} - I_{\text{min}}}$$

The value of R_L may then be substituted in the following formula for calculating power output.

$$P_o = \frac{[I_{\text{max}} - I_{\text{min}} + 1.41 (I_x - I_y)]^2 R_L}{32}$$

In both of these formulas, I is in amperes, E is in volts, R_L is in ohms, and P_o is in watts. I_x and I_y are the current values on the load line at bias voltages of $E_{c1} = V - 0.707V = 0.293V$ and $E_{c1} = V + 0.707V = 1.707V$, respectively.

Calculations for distortion may be made by means of the following formu-

las. The terms used have already been defined.

$$\% \text{ 2nd-harmonic distortion} = \frac{I_{\text{max}} + I_{\text{min}} - 2 I_o}{I_{\text{max}} - I_{\text{min}} + 1.41 (I_x - I_y)} \times 100$$

$$\% \text{ 3rd-harmonic distortion} = \frac{I_{\text{max}} - I_{\text{min}} - 1.41 (I_x - I_y)}{I_{\text{max}} - I_{\text{min}} + 1.41 (I_x - I_y)} \times 100$$

$$\% \text{ total (2nd and 3rd) harmonic distortion} = \sqrt{(\% \text{ 2nd})^2 + (\% \text{ 3rd})^2}$$

Conversion Factors

Operating conditions for voltage values other than those shown in the published data can be obtained by use of the nomograph shown in Fig. 44 when all electrode voltages are changed simultaneously in the same ratio. The nomograph includes conversion factors for current (F_i), power output (F_p), plate resistance or load resistance (F_r), and transconductance (F_{gm}) for voltage ratios between 0.5 and 2.0. These factors are expressed as functions of the ratio between the desired or new voltage for any electrode (E_{des}) and the published or original value of that voltage (E_{pub}). The relations shown are applicable to triodes and multigrid tubes in all classes of service.

To use the nomograph, simply place a straight-edge across the page so that it intersects the scales for E_{des} and E_{pub} at the desired values. The desired conversion factor may then be read directly or estimated at the point where the straight-edge intersects the F_i , F_p , F_r , or F_{gm} scale.

For example, suppose it is desired to operate two 6L6GC's in class A₁ push-pull, fixed bias, with a plate voltage of 200 volts. The nearest published operating conditions for this class of service are for a plate voltage of 250 volts. The operating conditions for the new plate voltage can be determined as follows:

The voltage conversion factor, F_v , is equal to 200/250 or 0.8. The dashed lines on the nomograph of Fig. 44 indicate that for this voltage ratio F_1 is approximately 0.72, F_p is approximately 0.57, F_r is 1.12, and F_{gm} is approximately 0.892. These factors may be applied directly to operating values shown in the tube data, or to values calculated by the methods described previously.

Because this method for conversion

of characteristics is necessarily an approximation, the accuracy of the nomograph decreases progressively as the ratio E_{des}/E_{pub} departs from unity. In general, results are substantially correct when the value of the ratio E_{des}/E_{pub} is between 0.7 and 1.5. Beyond these limits, the accuracy decreases rapidly, and the results obtained must be considered rough approximations.

The nomograph does not take into consideration the effects of contact potential or secondary emission in tubes. Because contact-potential effects become noticeable only at very small dc grid-No. 1 (bias) voltages, they are generally negligible in power tubes. Secondary emission may occur in conventional tetrodes, however, if the plate voltage swings below the grid-No. 2 voltage. Consequently, the conversion

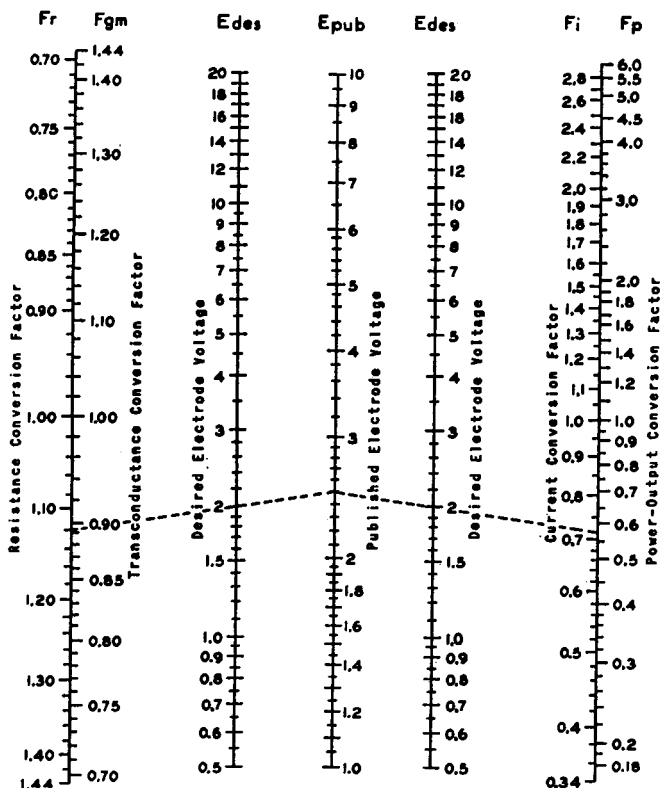

Fig. 44—Nomograph of tube conversion factors.

factors shown in the nomograph apply to such tubes only when the plate voltage is greater than the grid-No. 2 voltage. Because secondary emission may also occur in certain beam power tubes at very low values of plate current and plate voltage, the conversion factors shown in the nomograph do not apply when these tubes are operated under such conditions.

Class AB Power Amplifiers

A class AB power amplifier employs two tubes connected in push-pull with a higher negative grid bias than is used in a class A stage. With this higher negative bias, the plate and screen-grid voltages can usually be made higher than for class A amplifiers because the increased negative bias holds plate current within the limit of the tube plate-dissipation rating. As a result of these higher voltages, more power output can be obtained from class AB operation.

Class AB amplifiers are subdivided into class AB₁ and class AB₂. In class AB₁, there is no flow of grid current. That is, the peak signal voltage applied to each grid is not greater than the negative grid-bias voltage. The grids therefore are not driven to a positive potential and do not draw current. In class AB₂, the peak signal voltage is greater than the bias so that the grids are driven positive and draw current.

Because of the flow of grid current in a class AB₂ stage, there is a loss of power in the grid circuit. The sum of this loss and the loss in the input transformer is the total driving power required by the grid circuit. The driver stage should be capable of a power output considerably larger than this required power in order that distortion introduced in the grid circuit be kept low. The input transformer used in a class AB₂ amplifier usually has a step-down turns ratio.

Because of the large fluctuations of plate current in a class AB₂ stage, it is important that the plate power supply have good regulation. Otherwise the fluctuations in plate current cause fluctuations in the voltage output of the power supply, with the result that power output is decreased and distortion is increased. To obtain satisfactory regulation, it is usually advisable to use a low-drop rectifier, such as the 5V4GA, with a choke-input filter. In all cases, the resistance of the choke and transformers should be as low as possible.

Class AB₁ Power Amplifiers

In class AB₁ push-pull amplifier service using triodes, the operating conditions may be determined graphically by means of the plate family if E_0 , the desired operating plate voltage, is given. In this service, the dynamic load line does not pass through the operating point P as in the case of the single-tube amplifier, but through the point D in Fig. 45. Its position is not affected by the operating grid bias provided the plate-to-plate load resistance remains constant.

Under these conditions, grid bias has no appreciable effect on the power

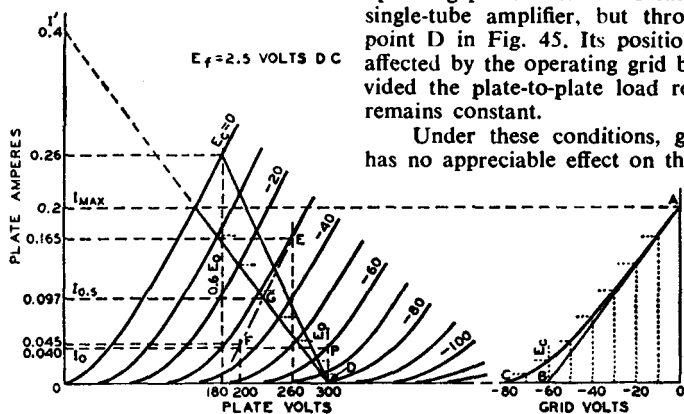

Fig. 45—Graphic calculations for class AB₁ amplifier using a power triode.

Fig. 46—Instantaneous curve for class AB₂ amplifier.

output. Grid bias cannot be neglected, however, since it is used to find the zero-signal plate current and, from it, the zero-signal plate dissipation. Because the grid bias is higher in class AB₁ than in class A service for the same plate voltage, a higher signal voltage may be used without grid current being drawn and, therefore, higher power output is obtained.

In general, for any load line through point D, Fig. 45, the plate-to-plate load resistance in ohms of a push-pull amplifier is $R_{pp} = 4E_o/I'$, where I' is the plate-current value in amperes at which the load line as projected intersects the plate-current axis, and E_o is in volts. This formula is another form of the one given under push-pull class A amplifiers, $R_{pp} = 4(E_o - 0.6E_o)/I_{max}$, but is more general. Power output = $(I_{max}/\sqrt{2})^2 \times R_{pp}/4$, where I_{max} is the peak plate current at zero grid volts for the load chosen. This formula simplified is $(I_{max})^2 \times R_{pp}/8$. The maximum-signal average plate current is $2I_{max}/\pi$ or $0.636 I_{max}$; the maximum-signal average power input is $0.636 I_{max} \times E_o$.

It is desirable to simplify these formulas for a first approximation. This simplification can be made if it is assumed that the peak plate current, I_{max} , occurs at the point of the zero-bias curve corresponding approximately to $0.6 E_o$, the condition for maximum power output. The simplified formulas are:

$$P_o \text{ (for two tubes)} = (I_{max} \times E_o)/5 \\ R_{pp} = 1.6E_o/I_{max}$$

where E_o is in volts, I_{max} is in amperes, R_{pp} is in ohms, and P_o is in watts.

It may be found during subsequent calculations that the distortion or the plate dissipation is excessive for this approximation; in that case, a different load resistance must be selected, using the first approximation as a guide, and the process repeated to obtain satisfactory operating conditions.

Example: Fig. 45 illustrates the application of this method to a pair of power triodes operated at $E_o = 300$ volts. Each tube has a plate-dissipation rating of 15 watts. The method is to

erect a vertical line at $0.6E_o$, or at 180 volts, which intersects the $E_c = 0$ curve at the point $I_{max} = 0.26$ ampere. Using the simplified formulas, the following values are obtained:

$$R_{pp} = (1.6 \times 300)/0.26 = 1845 \text{ ohms} \\ P_o = (0.26 \times 300)/5 = 15.6 \text{ watts}$$

At this point, it is well to determine the plate dissipation and to compare it with the maximum rated value. From the average-plate-current formula ($0.636 I_{max}$) mentioned previously, the maximum-signal average plate current is 0.166 ampere. The product of this current and the operating plate voltage is 49.8 watts, the average input to the two tubes. From this value, subtract the power output of 15.6 watts to obtain the total dissipation for both tubes, which is 34.2 watts. Half of this value, 17 watts, is in excess of the 15-watt rating of the tube and it is necessary, therefore, to assume another and higher load resistance so that the plate-dissipation rating will not be exceeded.

It will be found that at an operating plate voltage of 300 volts the tubes require a plate-to-plate load resistance of 3000 ohms. From the formula for R_{pp} , the value of I' is found to be 0.4 ampere. The load line for the 3000-ohm load resistance is then represented by a straight line from the point $I' = 0.4$ ampere on the plate-current ordinate to the point $E_o = 300$ volts on the plate-voltage abscissa. At the intersection of the load line with the zero-bias curve, the peak plate current, I_{max} , can be read at 0.2 ampere. Then

$$P_o = (I_{max}/\sqrt{2})^2 \times R_{pp}/4 \\ = (0.2/1.41)^2 \times 3000/4 \\ = 15 \text{ watts}$$

Proceeding as in the first approximation, it is found that the maximum-signal average plate current, $0.636I_{max}$, is 0.127 ampere, and the maximum-signal average power input is 38.1 watts. This input minus the power output is $38.1 - 15 = 23.1$ watts. This value is the dissipation for two tubes; the value per tube is 11.6 watts, a value well within the rating of this tube type.

The operating bias and the zero-signal plate current may then be found by use of a curve which is derived from

the plate family and the load line. Fig. 46 is a curve of instantaneous values of plate current and dc grid-bias voltages taken from Fig. 45. Values of grid bias are read from each of the grid-bias curves of Fig. 45 along the load line and are transferred to Fig. 46 to produce the curved line from A to C. A tangent to this curve, starting at A, is drawn to intersect the grid-voltage abscissa. The point of intersection, B, is the operating grid bias for fixed-bias operation. In the example, the bias is -60 volts. Refer back to the plate family at the operating conditions of plate volts = 300 and grid bias = -60 volts; the zero-signal plate current per tube is seen to be 0.04 ampere.

This procedure locates the operating point for each tube at P. The plate current must be doubled, of course, to obtain the zero-signal plate current for both tubes. Under maximum-signal conditions, the signal voltage swings from zero-signal bias voltage to zero bias for each tube on alternate half cycles. Hence, in the example, the peak of signal voltage per tube is 60 volts, or the grid-to-grid value is 120 volts.

As in the case of the push-pull class A amplifier, the second-harmonic distortion in a class AB₁ amplifier using triodes is very small and is largely canceled by virtue of the push-pull connection. Third-harmonic distortion, however, which may be larger than permissible, can be found by means of composite characteristic curves. A complete family of curves can be plotted, but for the present purpose only the one corresponding to a grid bias of one-half the peak grid-voltage swing is needed. In the example, the peak grid voltage per tube is 60 volts, and the half value is 30 volts. The composite curve, since it is nearly a straight line, can be constructed with only two points (see Fig. 45). These two points are obtained from deviations above and below the operating grid and plate voltages.

In order to find the curve for a bias of -30 volts, a deviation of 30 volts from the operating grid voltage of -60 volts is assumed. Next assume a deviation from the operating plate voltage of, say, 40 volts. Then at 300

$-40 = 260$ volts, erect a vertical line to intersect the $(-60) - (-30) = -30$ -volt bias curve and read the plate current at this intersection, which is 0.167 ampere; likewise, at the intersection of a vertical line at $300 + 40 = 340$ volts and the $(-60) + (-30) = -90$ -volt bias curve, read the plate current. In this example, the plate current is estimated to be 0.002 ampere. The difference of 0.165 ampere between these two currents determines the point E on the $300 - 40 = 260$ -volt vertical. Similarly, another point F on the same composite curve is found by assuming the same grid-bias deviation but a larger plate-voltage deviation, say, 100 volts.

These steps provide points at 260 volts and 0.165 ampere (E), and at 200 volts and 0.045 ampere (F). A straight line through these points is the composite curve for a bias of -30 volts, shown as a long-short dash line in Fig. 45. At the intersection of the composite curve and the load line, G, the instantaneous composite plate current at the point of one-half the peak signal swing is determined. This current value, designated $I_{0.5}$ and the peak plate current, I_{max} , are used in the following formula to find the peak value of the third-harmonic component of plate current.

$$I_{h3} = (2I_{0.5} - I_{max})/3$$

In the example, where $I_{0.5}$ is 0.097 ampere and I_{max} is 0.2 ampere, $I_{h3} = (2 \times 0.097 - 0.2)/3 = (0.194 - 0.2)/3 = -0.006/3 = -0.002$ ampere. (The fact that I_{h3} is negative indicates that the phase relation of the fundamental (first-harmonic) and third-harmonic components of the plate current is such as to result in a slightly peaked wave form. I_{h3} is positive in some cases, indicating a flattening of the wave form.)

The peak value of the fundamental or first-harmonic component of the plate current is found by the following formula:

$$I_{h1} = 2/3 \times (I_{max} + I_{0.5})$$

In the example, $I_{h1} = 2/3 \times (0.2 + 0.097) = 0.198$ ampere. Thus, the percentage of third-harmonic distortion is $(I_{h3}/I_{h1}) \times 100 = (0.002/0.198) \times 100 = 1$ per cent approx.

Class AB₂ Power Amplifiers

A class AB₂ amplifier employs two tubes connected in push-pull as in the case of class AB₁ amplifiers. It differs in that it is biased so that plate current flows for somewhat more than half the electrical cycle but less than the full cycle, the peak signal voltage is greater than the dc bias voltage, grid current is drawn, and, consequently, power is consumed in the grid circuit. These conditions permit high power output to be obtained without excessive plate dissipation.

The sum of the power used in the grid circuit and the losses in the input transformer is the total driving power required by the grid circuit. The driver stage should be capable of a power output considerably larger than this required power in order that distortion introduced in the grid circuit be kept low. In addition, the internal impedance of the driver stage as reflected into or as effective in the grid circuit of the power stage should always be as low as possible in order that distortion may be kept low. The input transformer used in a class AB₂ stage usually has a step-down ratio adjusted for this condition.

Load resistance, plate dissipation, power output, and distortion determinations are similar to those for class AB₁. These quantities are interdependent with peak grid-voltage swing and driving power; a satisfactory set of operating conditions involves a series of approximations. The load resistance and signal swing are limited by the permissible grid current and power and the distortion. If the load resistance is too high or the signal swing is excessive, the plate-dissipation rating will be exceeded, distortion will be high, and the driving power will be unnecessarily high.

Class B Power Amplifiers

A class B amplifier employs two tubes connected in push-pull, so biased that plate current is almost zero when no signal voltage is applied to the grids. Because of this low value of no-signal plate current, class B amplification has the same advantage as class AB₂, *i.e.*, large power output can be obtained without excessive plate dissipation.

Class B operation differs from class AB₂ in that plate current is cut off for a larger portion of the negative grid swing, and the signal swing is usually larger than in class AB₂ operation.

Because certain triodes used as class B amplifiers are designed to operate very close to zero bias, the grid of each tube is at a positive potential during all or most of the positive half-cycle of its signal swing. In this type of triode operation, considerable grid current is drawn and there is a loss of power in the grid circuit. This condition imposes the same requirement in the driver stage as in a class AB₂ stage; *i.e.*, the driver should be capable of delivering considerably more power output than the power required for the grid circuit of the class B amplifier so that distortion will be low. Similarly, the interstage transformer between the driver and the class B stage usually has a step-down turns ratio. Because of the high dissipations involved in class B operation at zero bias, it is not feasible to use tetrodes or pentodes in this type of class B operation.

Determination of load resistance, plate dissipation, power output, and distortion is similar to that for a class AB₂ stage.

Power amplifier tubes designed for class A operation can be used in class AB₂ and class B service under suitable operating conditions. There are several tube types designed especially for class B service. The characteristic common to all of these types is a high amplification factor. With a high amplification factor, plate current is small even when the grid bias is zero. These tubes, therefore, can be operated in class B service at a bias of zero volts so that no bias supply is required. A number of class B amplifier tubes consist of two triode units mounted in one tube. The two units can be connected in push-pull so that only one tube is required for a class B stage.

Cathode-Drive Circuits

The preceding text has discussed the use of tubes in the conventional grid-drive type of amplifier—that is,

where the cathode is common to both the input and output circuits. Tubes may also be employed as amplifiers in circuit arrangements which utilize the grid or plate as the common terminal. Probably the most important of these amplifiers are the cathode-drive circuit, which is discussed below, and the cathode-follower circuit, which will be discussed later in connection with inverse feedback.

A typical **cathode-drive** circuit is shown in Fig. 47. The load is placed in

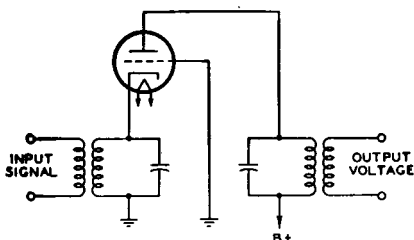

Fig. 47—Cathode-drive circuit.

the plate circuit and the output voltage is taken off between the plate and ground as in the grid-drive method of operation. The grid is grounded, and the input voltage is applied across an appropriate impedance in the cathode circuit. The cathode-drive circuit is particularly useful for vhf and uhf applications, in which it is necessary to obtain the low-noise performance usually associated with a triode, but where a conventional grid-drive circuit would be unstable because of feedback through the grid-to-plate capacitance of the tube. In the cathode-drive circuit, the grounded grid serves as a capacitive shield between plate and cathode and permits stable operation at frequencies higher than those in which conventional circuits can be used.

The input impedance of a cathode-drive circuit is approximately equal to $1/g_m$ when the load resistance is small compared to the r_p of the tube. A certain amount of power is required, therefore, to drive such a circuit. However, in the type of service in which cathode-drive circuits are normally used, the advantages of the grounded-grid connection usually outweigh this disadvantage.

Inverse Feedback

An inverse-feedback circuit, sometimes called a **degenerative** circuit, is one in which a portion of the output voltage of a tube is applied to the input of the same or a preceding tube in opposite phase to the signal applied to the tube. Two important advantages of feedback are (1) reduced distortion from each stage included in the feedback circuit and (2) reduction in the variations in gain due to changes in line voltage, possible differences between tubes of the same type, or variations in the values of circuit constants included in the feedback circuit.

Inverse feedback is used in audio amplifiers to reduce distortion in the output stage where the load impedance on the tube is a loudspeaker. Because the impedance of a loudspeaker is not constant for all audio frequencies, the load impedance on the output tube varies with frequency. When the output tube is a pentode or beam power tube having high plate resistance, this variation in plate load impedance can, if not corrected, produce considerable frequency distortion. Such frequency distortion can be reduced by means of inverse feedback. Inverse-feedback circuits are of the **constant-voltage** type and the **constant-current** type.

The application of the **constant-voltage** type of inverse feedback to a power-output stage using a single beam power tube is illustrated in Fig. 48. In this circuit, R_1 , R_2 , and C are connected as a voltage divider across the output of the tube. The secondary winding of the grid-input transformer is returned to a point on this voltage divider. Capacitor

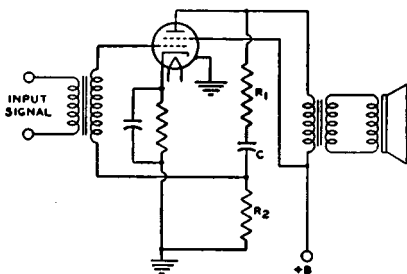

Fig. 48—Power-output stage using constant voltage inverse feedback.

C blocks the dc plate voltage from the grid. However, a portion of the tube af output voltage, approximately equal to the output voltage multiplied by the fraction $R_2/(R_1 + R_2)$, is applied to the grid. This voltage reduces the source impedance of the circuit and a decrease in distortion results which is explained in the curves of Fig. 49.

ment of plate current i'_{pr} . It is evident that the irregularity of the waveform of this component of plate current would act to cancel the original irregularity and thus reduce distortion.

After inverse feedback has been applied, the relations are as shown in the curve for i_p . The dotted curve shown by i'_{pr} is the component of plate current

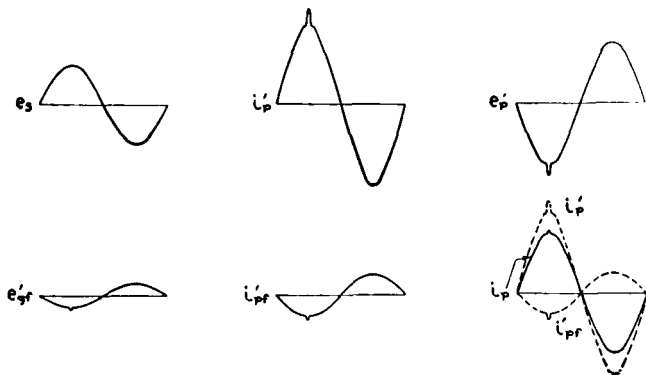

Fig. 49—Voltage and current waveforms showing effect of inverse feedback.

Consider first the amplifier without the use of inverse feedback. Suppose that when a signal voltage e_s is applied to the grid the af plate current i'_p has an irregularity in its positive half-cycle. This irregularity represents a departure from the waveform of the input signal and is, therefore, distortion. For this plate-current waveform, the af plate voltage has a waveform shown by e'_p . The plate-voltage waveform is inverted compared to the plate-current waveform because a plate-current increase produces an increase in the drop across the plate load. The voltage at the plate is the difference between the drop across the load and the supply voltage; thus, when plate current goes up, plate voltage goes down; when plate current goes down, plate voltage goes up.

Now suppose that inverse feedback is applied to the amplifier. The voltage fed back to the grid has the same waveform and phase as the plate voltage, but is smaller in magnitude. Hence, with a plate voltage of waveform shown by e'_p , the feedback voltage appearing on the grid is as shown by e'_{gr} . This voltage applied to the grid produces a compo-

due to the feedback voltage on the grid. The dotted curve shown by i'_{pr} is the component of plate current due to the signal voltage on the grid. The algebraic sum of these two components gives the resultant plate current shown by the solid curve of i_p . Since i'_{pr} is the plate current that would flow without inverse feedback, it can be seen that the application of inverse feedback has reduced the irregularity in the output current. In this manner inverse feedback acts to correct any component of plate current that does not correspond to the input signal voltage, and thus reduces distortion.

From the curve for i_p , it can be seen that, besides reducing distortion, inverse feedback also reduces the amplitude of the output current. Consequently, when inverse feedback is applied to an amplifier there is a decrease in gain or power sensitivity as well as a decrease in distortion. Hence, the application of inverse feedback to an amplifier requires that more driving voltage be applied to obtain full power output, but this output is obtained with less distortion.

Inverse feedback may also be applied to resistance-coupled stages, as shown in Fig. 50. The circuit is conventional except that a feedback resistor,

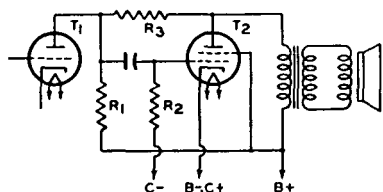

Fig. 50—Resistance-coupled stages using feedback resistor.

R_3 , is connected between the plates of tubes T_1 and T_2 . The output signal voltage of T_1 and a portion of the output signal voltage of T_2 appear across R_3 . Because the distortion generated in the plate circuit of T_2 is applied to its grid out of phase with the input signal, the distortion in the output of T_2 is comparatively low. With sufficient inverse feedback of the constant-voltage type in a power-output stage, it is not necessary to employ a network of resistance and capacitance in the output circuit to reduce response at high audio frequencies. Inverse-feedback circuits can also be applied to push-pull class A and class AB_1 amplifiers.

Constant-current inverse feedback is usually obtained by omitting the bypass capacitor across a cathode resistor. This method decreases the gain and the distortion but increases the source impedance of the circuit. Consequently, the output voltage rises at the resonant frequency of the loudspeaker and accentuates hangover effects.

Inverse feedback is not generally applied to a triode power amplifier because the variation in speaker impedance with frequency does not produce much distortion in a triode stage having low plate resistance. It is sometimes applied in a pentode stage, but is not always convenient. As has been shown, when inverse feedback is used in an amplifier, the driving voltage must be increased in order to provide full power output. When inverse feedback is used with a pentode, the total driving voltage required for full power output may be inconveniently large, although still less

than that required for a triode. Because a beam power tube gives full power output on a comparatively small driving voltage, inverse feedback is especially applicable to beam power tubes. By means of inverse feedback, the high efficiency and high power output of beam power tubes can be combined with freedom from the effects of varying speaker impedance.

Cathode-Follower Circuits

Another important application of inverse feedback is in the cathode-follower circuit, an example of which is shown in Fig. 51. In this application, the load has been transferred from the plate circuit to the cathode circuit of the tube. The input voltage is applied between the grid and ground, and the output voltage is obtained between the cathode and ground. The voltage amplification (V.A.) of this circuit is always less than unity and may be expressed by the following convenient formulas.

For a triode:

$$V. A. = \frac{\mu \times R_L}{r_p + [R_L \times (\mu + 1)]}$$

For a pentode:

$$V. A. = \frac{g_m \times R_L}{1 + (g_m \times R_L)}$$

In these formulas, μ is the amplification factor, R_L is the load resistance in ohms, r_p is the plate resistance in ohms, and g_m is the transconductance in mhos.

The use of the cathode follower permits the design of circuits which have high input resistance and high output voltage. The output impedance is

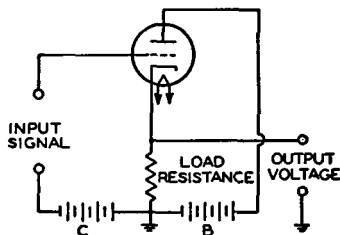

Fig. 51—Cathode-follower circuit.

quite low and very low distortion may be obtained. Cathode-follower circuits may be used for power amplifiers or as impedance transformers designed either

to match a transmission line or to produce a relatively high output voltage at a low impedance level.

In a power amplifier which is transformer coupled to the load, the same output power can be obtained from the tube as would be obtained in a conventional grid-drive type of amplifier. The output impedance is very low and provides excellent damping to the load, with the result that very low distortion can be obtained. The peak-to-peak signal voltage, however, approaches $1\frac{1}{2}$ times the plate supply voltage if maximum power output is required from the tube. Some problems may be encountered, therefore, in the design of an adequate driver stage for a cathode-follower output system.

When a cathode-follower circuit is used as an impedance transformer, the load is usually a simple resistance in the cathode circuit of the tube. With relatively low values of cathode resistor, the circuit may be designed to supply significant amounts of power and to match the impedance of the device to a transmission line. With somewhat higher values of cathode resistor, the circuit may be used to decrease the output impedance sufficiently to permit the transmission of audio signals along a line in which appreciable capacitance is present.

The cathode follower may also be used as an isolation device to provide extremely high input resistance and low input capacitance as might be required in the probe of an oscilloscope or vacuum-tube voltmeter. Such circuits can be designed to provide effective impedance transformation with no significant loss of voltage.

Selection of a suitable tube and its operating conditions for use in a cathode-follower circuit having a specified output impedance (Z_o) can be made, in most practical cases, by the use of the following formula to determine the approximate value of the required tube transconductance.

$$\text{Required } g_m (\mu\text{mhos}) = \frac{1,000,000}{Z_o (\text{ohms})}$$

Once the required transconductance is obtained, a suitable tube and its operating conditions may be determined

from the technical data given in the **Technical Data** section. The tube selected should have a value of transconductance slightly lower than that obtained from the above expression to allow for the shunting effect of the cathode load resistance. The conversion nomograph given in Fig. 44 may be used for calculation of operating conditions for values of transconductance not included in the tabulated data. After the operating conditions have been determined, the approximate value of the required cathode load resistance may be calculated from the following formulas. For a triode:

$$\text{Cathode } R_{L1} = \frac{Z_o \times r_p}{r_p - [Z_o \times (1 + \mu)]}$$

For a pentode:

$$\text{Cathode } R_{L1} = \frac{Z_o}{1 - (g_m \times Z_o)}$$

Resistance and impedance values are in ohms; transconductance values are in mhos.

If the value of the cathode load resistance calculated to provide the required output impedance does not provide the required operating bias, the basic cathode-follower circuit can be modified in a number of ways. Two of the more common modifications are shown in Figs. 52 and 53.

In Fig. 52 the bias is increased by adding a bypassed resistance between

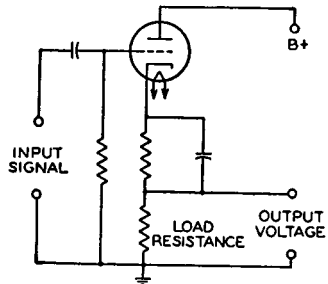

Fig. 52—Cathode-follower circuit modified for increased bias.

the cathode and the unbypassed load resistance and returning the grid to the low end of the load resistance. In Fig. 53 the bias is reduced by adding a bypassed resistance between the cathode and the unbypassed load resistance but, in this case, the grid is returned to the

junction of the two cathode resistors so that the bias voltage is only the dc voltage drop across the added resistance. The size of the bypass capacitor should be large enough so that it has negligible reactance at the lowest frequency to be handled. In both cases the B-supply should be increased to make up for the voltage taken for biasing.

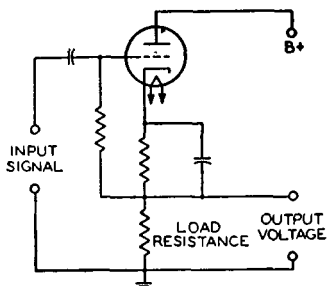

Fig. 53—Cathode-follower circuit modified for reduced bias.

Example: Select a suitable tube and determine the operating conditions and circuit components for a cathode-follower circuit having an output impedance that will match a 500-ohm transmission line.

Procedure: First, determine the approximate transconductance required.

$$\text{Required } g_m = \frac{1,000,000}{500} = 2000 \mu\text{mhos}$$

A survey of the tubes that have a transconductance in this order of magnitude shows that type 12AX7A is among the tubes to be considered. Referring to the characteristics given in the technical data section for one triode unit of high-mu twin triode 12AX7, we find that for a plate voltage of 250 volts and a bias of -2 volts, the transconductance is 1600 micromhos, the plate resistance is 62500 ohms, the amplification factor is 100, and the plate current is 0.0012 ampere. When these values are used in the expression for determining the cathode load resistance, the following result is obtained:

$$\text{Cathode } R_L = \frac{500 \times 62500}{62500 - 500 \times (100 + 1)} = 2600 \text{ ohms}$$

The voltage across this resistor for a plate current of 0.0012 ampere is $2600 \times 0.0012 = 3.12$ volts. Because

the required bias voltage is only -2 volts, the circuit arrangement given in Fig. 53 is employed. The bias is furnished by a resistance that will have a voltage drop of 2 volts when it carries a current of 0.0012 ampere. The required bias resistance, therefore, is $2/0.0012 = 1670$ ohms. If 60 Hz is the lowest frequency to be passed, 20 microfarads is a suitable value for the bypass capacitor. The B-supply, of course, is increased by the voltage drop across the cathode resistance which, in this example, is approximately 5 volts. The B-supply, therefore, is $250 + 5 = 255$ volts.

Because it is desirable to eliminate, if possible, the bias resistor and bypass capacitor, it is worthwhile to try other tubes and other operating conditions to obtain a value of cathode load resistance which will also provide the required bias. If the triode section of twin diode—high-mu triode 6AT6 is operated under the conditions given in the technical data section with a plate voltage of 100 volts and a bias of -1 volt, it will have an amplification factor of 70, a plate resistance of 54000 ohms, a transconductance of 1300 micromhos, and a plate current of 0.0008 ampere. Then,

$$\text{Cathode } R_L = \frac{500 \times 54000}{54000 - 500 \times (70 + 1)} = 1460 \text{ ohms}$$

The bias voltage obtained across this resistance is $1460 \times 0.0008 = 1.17$ volts. Since this value is for all practical purposes close enough to the required bias, no addition bias resistance will be required and the grid may be returned directly to ground. There is no need to adjust the B-supply voltage to make up for the drop in the cathode resistor. The voltage amplification (V.A.) for the cathode-follower circuit utilizing the triode section of type 6AT6 is

$$\text{V.A.} = \frac{70 \times 1460}{54000 + 1460 \times (70 + 1)} = 0.65$$

For applications in which the cathode follower is used to isolate two circuits—for example, when it is used between a circuit being tested and the input stage of an oscilloscope or a vacuum-tube voltmeter—voltage output

and not impedance matching is the primary consideration. In such applications it is desirable to use a relatively high value of cathode load resistance, such as 50,000 ohms, in order to get the maximum voltage output. In order to obtain proper bias, a circuit such as that of Fig. 53 should be used. With a high value of cathode resistance, the voltage amplification will approximate unity.

Corrective Filters

A corrective filter can be used to improve the frequency characteristic of an output stage using a beam power tube or a pentode when inverse feedback is not applicable. The filter consists of a resistor and a capacitor connected in series across the primary of the output transformer. Connected in this way, the filter is in parallel with the plate load impedance reflected from the voice-coil by the output transformer. The magnitude of this reflected impedance increases with increasing frequency in the middle and upper audio range. The impedance of the filter, however, decreases with increasing frequency. It follows that, by use of the proper values for the resistance and the capacitance in the filter, the effective load impedance on the output tubes can be made practically constant for all frequencies in the middle and upper audio range. The result is an improvement in the frequency characteristic of the output stage.

The resistance to be used in the filter for a push-pull stage is 1.3 times the recommended plate-to-plate load resistance; or, for a single-tube stage, is 1.3 times the recommended plate load resistance. The capacitance in the filter should have a value such that the voltage gain of the output stage at a frequency of 1000 Hz or higher is equal to the voltage gain at 400 Hz.

A method of determining the proper value of capacitance for the filter is to make two measurements of the output voltage across the primary of the output transformer: first, when a 400-Hz signal is applied to the input, and second, when a 1000-Hz signal of the same voltage as the 400-Hz signal is applied to the input. The correct value of capacitance is the one which gives equal output voltages for the two signal inputs. In practice, this value is usually found to be in the order of 0.05 microfarad.

Phonograph and Tape Preamplifiers

The frequency range and dynamic range* which can be recorded on a phonograph record or on magnetic tape depend on several factors, including the composition, mechanical characteristics, and speed of the record or tape, and the electrical and mechanical characteristics of the recording equipment. To achieve wide frequency and dynamic ranges, manufacturers of commercial recordings use equipment which introduces a nonuniform relationship between amplitude and frequency. This relationship is known as a "recording characteristic." To assure proper reproduction of a high-fidelity recording, therefore, some part of the reproducing system must have a frequency-response characteristic which is the inverse of the recording characteristic. Most manufacturers of high-fidelity recordings use the RIAA characteristic for discs and the NARTB characteristic for magnetic tape.

The simplest type of equalization network is shown in Fig. 54. Because the capacitor C is effectively an open circuit at low frequencies, the low frequencies must be passed through the resistor R and are attenuated. The capacitor has a lower reactance at high

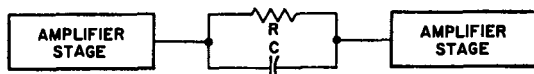

Fig. 54—Simple RC frequency-compensation network.

* The dynamic range of an amplifier is a measure of its signal-handling capability. The dynamic range expresses in dB the ratio of the maximum usable output signal (generally for a distortion of about 10 per cent) to the minimum usable output signal (generally for a signal-to-noise ratio of about 20 dB). A dynamic range of 40 dB is usually acceptable; a value of 70 dB is exceptional for any audio system.

frequencies, however, and bypasses high-frequency components around R so that they receive negligible attenuation. Thus the network effectively "boosts" the high frequencies. This type of equalization is called "attenuative."

Some typical preamplifier stages are shown in the **Circuits** section. The location of the frequency-compensating network or "equalizer" in the reproducing system will depend on the types of recordings which are to be reproduced and on the pickup devices used.

A ceramic high-fidelity phonograph pickup is usually designed to provide proper compensation for the RIAA recording characteristic when the pickup is operated into the load resistance specified by its manufacturer. Because this type of pickup also has relatively high output (0.5 to 1.5 volts), it does not require the use of either an equalizer network or a preamplifier, and can be connected directly to the input of a tone-control amplifier and/or power amplifier.

A magnetic high-fidelity phonograph pickup, on the other hand, usually has an essentially flat frequency-response characteristic and very low output (1 to 10 millivolts). Because a pickup of this type merely reproduces the recording characteristic, it must be followed by an equalizer network, as well as by a preamplifier having sufficient voltage gain to provide the input voltage required by the tone-control amplifier and/or power amplifier. Many designs include both the equalizing and amplifying circuits in a single unit.

A high-fidelity magnetic-tape pickup head, like a magnetic phonograph pickup, reproduces the recording characteristic and has an output of only a few millivolts. This type of pickup device, therefore, must also be followed by an equalizing network and preamplifier, or by a preamplifier which provides "built-in" equalization for the NARTB characteristic.

Feedback networks may also be used for frequency compensation and for reduction of distortion. Basically, a feedback network returns a portion of the output signal to the input circuit of an amplifier. The feedback signal may be returned in phase with the input signal (**positive** or **regenerative feedback**) or 180 degrees out of phase with the input signal (**negative, inverse, or degenerative feedback**). In either case, the feedback can be made proportional to either the output voltage or the output current, and can be applied to either the input voltage or the input current. A negative feedback signal proportional to the output current raises the output impedance of the amplifier; negative feedback proportional to the output voltage reduces the output impedance. A negative feedback signal applied to the input current decreases the input impedance; negative feedback applied to the input voltage increases the input impedance. Opposite effects are produced by positive feedback.

A simple negative or inverse feedback network which provides high-frequency boost is shown in Fig. 55. This network provides equalization comparable to that obtained with Fig. 54, but is more suitable for low-level amplifier stages because it does not require the first amplifier stage to provide high-level low frequencies. In addition, the inverse feedback improves the distortion characteristics of the amplifier.

Some preamplifier or low-level audio amplifier circuits include variable resistors or potentiometers which function as **volume** or **tone controls**. Such circuits should be designed to minimize the flow of dc currents through these controls so that little or no noise will be developed by the movable contact during the life of the circuit. Volume controls and their associated circuits should permit variation of gain from zero to maximum, and should attenuate all frequencies equally for all positions

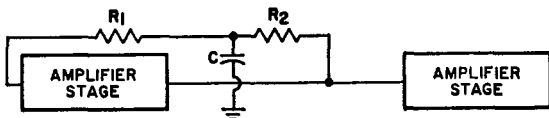

Fig. 55—Negative-feedback frequency-compensation network.

of the variable arm of the control. Several examples of volume controls and tone controls are shown in the **Circuits** section.

Tone Controls

A tone control is a variable filter (or one in which at least one element is adjustable) by means of which the user may vary the frequency response of an amplifier to suit his own taste. In radio receivers and home amplifiers, the tone control usually consists of a resistance-capacitance network in which the resistance is the variable element.

The simplest form of tone control is a fixed tone-compensating or "equalizing" network such as that shown in Fig. 56. This type of network is often

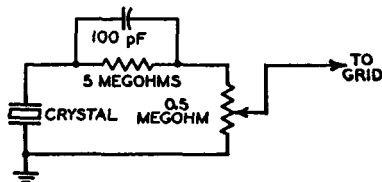

Fig. 56—Tone-control circuit for fixed tone compensation or "equalizing".

used to equalize the low- and high-frequency response of a crystal phonograph pickup. At low frequencies the attenuation of this network is 20.8 dB. As the frequency is increased, the 100-picofarad capacitor serves as a bypass for the 5-megohm resistor, and the combined impedance of the resistor-capacitor network is reduced. Thus, more of the crystal output appears across the 0.5-megohm resistor at high

frequencies than at low frequencies, and the frequency response at the grid is reasonably flat over a wide frequency range. Fig. 57 shows a comparison between the output of the crystal (curve A) and the output of the equalizing network (curve B). The response curve

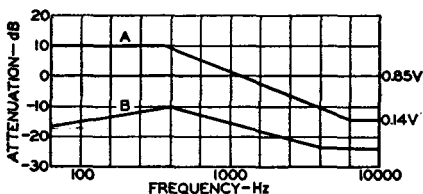

Fig. 57—Curve showing output from crystal phonograph pickup (A) and from equalizing network (B).

can be "flattened" still more if the attenuation at low frequencies is increased by changing the 0.5-megohm resistor to 0.125 megohm.

The tone-control network shown in Fig. 58 has two stages with completely separate bass and treble controls. Fig. 59 shows simplified representations of the bass control of this circuit when the potentiometer is turned to its extreme variations (usually labeled "Boost" and "Cut"). In this network, as in the crystal-equalizing network shown in Fig. 56, the parallel RC combination is the controlling factor. For bass "boost," the capacitor C_2 bypasses resistor R_3 so that less impedance is placed across the output to grid B at high frequencies than at low frequencies. For bass "cut," the parallel combination is shifted so that C_1 bypasses R_3 , causing more high-frequency than low-frequency output. Essentially, the network is a variable-

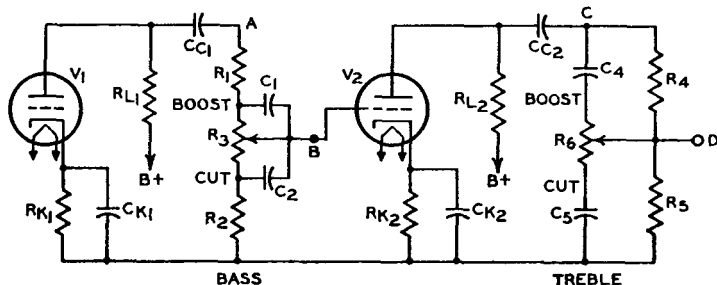

Fig. 58—Two-stage tone-control circuit incorporating separate bass and treble controls.

frequency voltage divider. With proper values for the components, it may be made to respond to changes in the R_3 potentiometer setting for only low frequencies (below 1000 Hz).

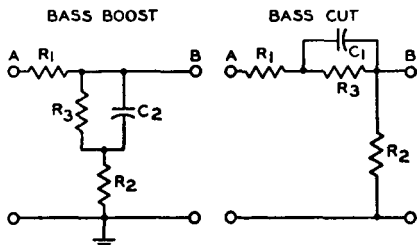

Fig. 59—Simplified representations of bass-control circuit at extreme ends of potentiometer.

Fig. 60 shows extreme positions of the treble control. The attenuation of the two circuits is approximately the same at 1000 Hz. The treble "boost" circuit is similar to the crystal-equalizing network shown in Fig. 56. In the treble "cut" circuit, the parallel RC elements serve to attenuate the signal voltage further because the capacitor bypasses the resistance across the output.

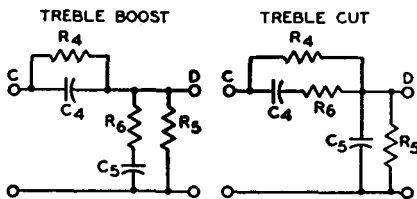

Fig. 60—Simplified representations of treble-control circuit at extreme ends of potentiometer.

The effect of the capacitor is negligible at low frequencies; beyond 1000 Hz, the signal voltage is attenuated at a maximum rate of 6 dB per octave.

The location of a tone-control network is of considerable importance. In a typical radio receiver, it may be inserted in the plate circuit of the power tube, the coupling circuit between the first af amplifier tube and the power tube, or the grid circuit of the first tube. In an amplifier using a beam power tube or pentode power amplifier without negative feedback, it is desirable to connect a resistance-

capacitance filter across the primary of the output transformer. This filter may be fixed, with a supplementary tone control elsewhere, or it may form the tone control itself. If the amplifier incorporates negative feedback, the tone control may be inserted in the feedback network or else should be connected to a part of the amplifier which is external to the feedback loop. The overall gain of a well designed tone-control network should be approximately unity.

Automatic Volume or Gain Control

The chief purpose of automatic volume control (avc) or automatic gain control (agc) in a radio or television receiver is to prevent fluctuations in loudspeaker volume or picture brightness when the audio or video signal at the antenna is fading in and out.

An automatic volume control circuit regulates the receiver rf and if gain so that this gain is less for a strong signal than for a weak signal. In this way, when the signal strength at the antenna changes, the avc circuit reduces the resultant change in the voltage output of the last if stage and consequently reduces the change in the speaker output volume.

The avc circuit reduces the rf and if gain for a strong signal usually by increasing the negative bias of the rf, if, and frequency-mixer stage when the signal increases. A simple avc circuit is shown in Fig. 61. On each positive half-cycle of the signal voltage, when the diode plate is positive with respect to the cathode, the diode passes current.

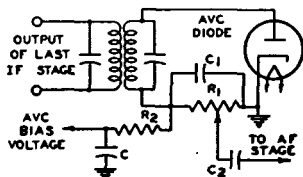

Fig. 61—Automatic-volume-control (avc) circuit.

Because of the flow of diode current through R_1 , there is a voltage drop across R_1 which makes the left end of R_1 negative with respect to ground. This

voltage drop across R_1 is applied, through the filter R_2 and C , as negative bias on the grids of the preceding stages. When the signal strength at the antenna increases, therefore, the signal applied to the avc diode increases, the voltage drop across R_1 increases, the negative bias voltage applied to the rf and if stages increases, and the gain of the rf and if stages is decreased. Thus the increase in signal strength at the antenna does not produce as much increase in the output of the last if stage as it would produce without avc.

When the signal strength at the antenna decreases from a previous steady value, the avc circuit acts, of course, in the reverse direction, applying less negative bias, permitting the rf and if gain to increase, and thus reducing the decrease in the signal output of the last if stage. In this way, when the signal strength at the antenna changes, the avc circuit acts to reduce change in the output of the last if stage, and thus acts to reduce change in loudspeaker volume.

The filter, C and R_2 , prevents the avc voltage from varying at audio frequency. The filter is necessary because the voltage drop across R_1 varies with the modulation of the carrier being received. If avc voltage were taken directly from R_1 without filtering, the audio variations in avc voltage would vary the receiver gain so as to smooth out the modulation of the carrier. To avoid this effect, the avc voltage is taken from the capacitor C . Because of the resistance R_2 in series with C , the capacitor C can charge and discharge at only a comparatively slow rate. The avc voltage therefore cannot vary at frequencies as high as the audio range but can vary at frequencies high enough to compensate for most fading. Thus the filter permits the avc circuit to smooth out variations in signal due to fading, but prevents the circuit from smoothing out audio modulation.

It will be seen that an avc circuit and a diode-detector circuit are much alike. It is therefore convenient in a receiver to combine the detector and the avc diode in a single stage. Examples of how these functions are combined in

receivers are shown in **Circuits** section.

In the circuit shown in Fig. 61, a certain amount of avc negative bias is applied to the preceding stages on a weak signal. Because it may be desirable to maintain the receiver rf and if gain at the maximum possible value for a weak signal, avc circuits are designed in some cases to apply no avc bias until the signal strength exceeds a certain value. These avc circuits are known as **delayed avc** or **davc** circuits.

A davc circuit is shown in Fig. 62. In this circuit, the diode section D_1 of the 6AL5 acts as detector and avc diode.

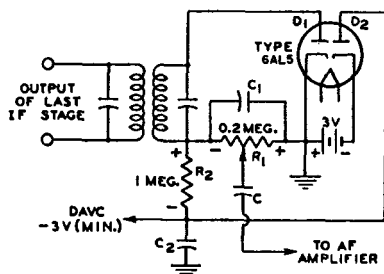

Fig. 62—Delayed avc (davc) circuit.

R_1 is the diode load resistor and R_2 and C_2 are the avc filter. Because the cathode of diode D_2 is returned through a fixed supply of -3 volts to the cathode of D_1 , a dc current flows through R_1 and R_2 in series with D_2 . The voltage drop caused by this current places the avc lead at approximately -3 volts (less the negligible drop through D_2). When the average amplitude of the rectified signal developed across R_1 does not exceed 3 volts, the avc lead remains at -3 volts. Hence, for signals not strong enough to develop 3 volts across R_1 , the bias applied to the controlled tubes stays constant at a value giving high sensitivity.

However, when the average amplitude of rectified signal voltage across R_1 exceeds 3 volts, the plate of diode D_2 becomes more negative than the cathode of D_2 and current flow in diode D_2 ceases. The potential of the avc lead is then controlled by the voltage developed across R_1 . Therefore, with further increase in signal strength, the avc circuit applies an increasing avc

bias voltage to the controlled stages. In this way, the circuit regulates the receiver gain for strong signals, but permits the gain to stay constant at a maximum value for weak signals.

It can be seen in Fig. 62 that a portion of the -3 volts delay voltage is applied to the plate of the detector diode D_1 , this portion being approximately equal to $R_1/(R_1 + R_2)$ times -3 volts. Hence, with the circuit constants as shown, the detector plate is made negative with respect to its cathode by approximately one-half volt. However, this voltage does not interfere with detection because it is not large enough to prevent current flow in the tube.

Automatic gain control (agc) compensates for fluctuations in rf picture carrier amplitude. The peak carrier level rather than the average carrier level is controlled by the agc voltage because the peaks of the sync pulses are fixed when inserted on a fixed carrier level. The peak carrier level may be determined by measurement of the peaks of the sync pulses at the output of the video detector.

A conventional agc circuit, such as that shown in Fig. 63, consists of a diode

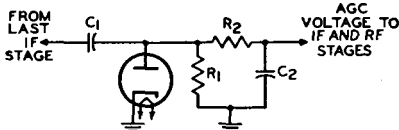

Fig. 63—Automatic-gain control (agc) circuit.

detector circuit and an RC filter. The time constant of the detector circuit is made large enough to prevent the picture content from influencing the magnitude of the agc voltage. The output voltage (agc voltage) is equal to the peak value of the incoming signal.

The diode detector receives the incoming signal from the last if stage of the television receiver through the capacitor C_1 . The resistor R_1 provides the load for the diode. The diode conducts only when its plate is driven positive with respect to its cathode. Electrons then flow from the cathode to the plate and thence into capacitor C_1 , where the negative charge is stored. Because of the

low impedance offered by the diode during conduction, C_1 charges up to the value of the peak applied voltage.

During the negative excursion of the signal, the diode does not conduct, and C_1 discharges through resistor R_1 . Because of the large time constant of R_1C_1 , however, only a small percentage of the voltage across C_1 is lost during the interval between horizontal sync pulses. During succeeding positive cycles, the incoming signal must overcome the negative charge stored in C_1 before the diode conducts, and plate current flows only at the peak of each positive cycle. The voltage across C_1 , therefore, is determined by the level of the peaks of the positive cycles, or the sync pulses.

The negative voltage developed across resistor R_1 by the sync pulses is filtered by resistor R_2 and capacitor C_2 to remove the 15,750-cycle ripple of the horizontal sync pulse. The dc output is then fed to the if and rf amplifiers as an agc voltage.

This agc system may be expanded to include amplification of the agc signal before detection of the peak level, or amplification of the dc output, or both. A direct-coupled amplifier must be used for amplification of the dc signal. The addition of amplification makes the system more sensitive to changes in carrier level.

A "keyed" agc system such as that shown in Fig. 64 is used to eliminate flutter and to improve noise immunity in weak signal areas. This system provides more rapid action than the conventional agc circuits because the filter circuit can employ lower capacitance and resistance values.

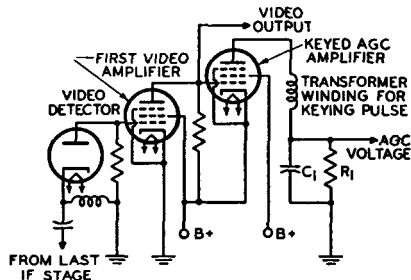

Fig. 64—"Keyed" agc circuit.

In the keyed agc system, the negative output of the video detector is fed directly to the grid No. 1 of the first video amplifier. The positive output of the video amplifier is, in turn, fed directly to the grid No. 1 of the keyed agc amplifier. The video stage increases the gain of the agc system and, in addition, provides noise clipping. The plate voltage for the agc amplifier is a positive pulse obtained from a small winding on the horizontal output transformer which is in phase with the horizontal sync pulse obtained from the video amplifier. The polarity of this pulse is such that the plate of the agc amplifier tube is positive during the retrace time. The tube is biased so that current flows only when the grid No. 1 and the plate are driven positive simultaneously. The amount of current flow depends on the grid-No. 1 potential during the pulse. These pulses are smoothed out in the RC network in the plate circuit (R_1C_1). Because the dc voltage developed across R_1 is negative, it is suitable for application to the grids of the rf and if tubes as an agc voltage.

High-Fidelity Amplifiers

Several high-fidelity amplifiers are shown in the **Circuits** section. The performance capabilities of such amplifiers are usually given in terms of frequency response, total harmonic distortion, maximum power output, and noise level.

To provide high-fidelity reproduction of audio program material, an amplifier should have a frequency response which does not vary more than 1 dB over the entire audio spectrum. General practice is to design the amplifier so that its frequency response is flat within 1 dB from a frequency below the lowest to be reproduced to one well above the upper limit of the audible region.

Harmonic distortion and intermodulation distortion produce changes in program material which may have adverse effects on the quality of the reproduced sound. **Harmonic distortion** causes a change in the character of an individual tone by the introduction of harmonics which were not originally present in the program material. For

high-fidelity reproduction, total harmonic distortion (expressed as a percentage of the output power) should not be greater than about 1 per cent at the desired listening level. Types such as the 6973, 7027A and 7868 are designed to provide extremely low harmonic distortion in suitably designed push-pull amplifier circuits.

Intermodulation distortion is a change in the waveform of an individual tone as a result of interaction with another tone present at the same time in the program material. This type of distortion not only alters the character of the modulated tone, but may also result in the generation of spurious signals at frequencies equal to the sum and difference of the interacting frequencies. Intermodulation distortion should be less than 2 per cent at the desired listening level. In general, any amplifier which has low intermodulation distortion will have very low harmonic distortion.

The maximum power output which a high-fidelity amplifier should deliver depends upon a complex relation of several factors, including the size and acoustical characteristics of the listening area, the desired listening level, and the efficiency of the loudspeaker system. Practically, however, it is possible to determine amplifier requirements in terms of room size and loudspeaker efficiency.

The acoustic power required to reproduce the loudest passages of orchestral music at concert-hall level in the average-size living room is about 0.4 watt. Because high-fidelity loudspeakers of the type generally available for home use have an efficiency of only about 5 per cent, the output stage of the amplifier should therefore be able to deliver a power output of at least 8 watts. Because many wide-range loudspeaker systems, particularly those using frequency-divider networks, have efficiencies of less than 5 per cent, output tubes used with such systems must have correspondingly larger power outputs. The 6973, 7027A, 7189, and 7868 can provide ample output for most systems when used in suitable push-pull circuits.

The noise level of a high-fidelity

amplifier determines the range of volume the amplifier is able to reproduce, *i.e.*, the difference (usually expressed in decibels) between the loudest and softest sounds in program material. Because the greatest volume range utilized in electrical program material at the present time is about 60 dB, the noise level of a high-fidelity amplifier should be at least 60 dB below the signal level at the desired listening level.

Limiters

An amplifier may also be used as a limiter. One use of a limiter is in receivers designed for the reception of frequency-modulated signals. The limiter in FM receivers has the function of eliminating amplitude variations from the input to the detector. Because in an FM system amplitude variations are primarily the result of noise disturbances, the use of a limiter prevents such disturbances from being reproduced in the audio output. The limiter usually follows the last if stage so that it can minimize the effects of disturbances coming in on the rf carrier and those produced locally.

The limiter is essentially an if voltage amplifier designed for saturated operation. Saturated operation means that an increase in signal voltage above a certain value produces very little increase in plate current. A signal voltage which is never less than sufficient to cause saturation of the limiter, even on weak signals, is supplied to the limiter input by the preceding stages. Any change in amplitude, therefore, such as might be produced by noise voltage fluctuation, is not reproduced in the limiter output. The limiting action, of course, does not interfere with the reproduction of frequency variations.

Plate-current saturation of the limiter may be obtained by the use of grid-No. 1 resistor-and-capacitor bias with plate and grid-No. 2 voltages which are low compared with customary if-amplifier operating conditions.

As a result of these design features, the limiter is able to maintain its output voltage at a constant amplitude over a wide range of input-signal voltage variations. The output of the limiter is frequency-modulated if voltage, the mean

frequency of which is that of the if amplifier. This voltage is impressed on the input of the detector.

The reception of FM signals without serious distortion requires that the response of the receiver be such that satisfactory amplification of the signal is provided over the entire range of frequency deviation from the mean frequency. Since the frequency at any instant depends on the modulation at that instant, it follows that excessive attenuation toward the edges of the band, in the rf or if stages, will cause distortion. In a high-fidelity receiver, therefore, the amplifiers must be capable of amplifying, for the maximum permissible frequency deviation of 75 kHz, a band 150 kHz wide. Suitable tubes for this purpose are the 6BA6 and 6BJ6.

Volume Compressors and Expanders

Volume compression and expansion are used in FM transmitters and receivers and in recording devices and amplifiers to make more natural the reproduction of music which has a very large volume range. For example, in the music of a symphony orchestra the sound intensity of the soft passages is very much lower than that of the loud passages. When this low volume level is raised above the background noise for transmitting or recording, the peak level of the program material may be raised to an excessively high volume level. It is often necessary, therefore, to compress the volume range of the program content within the maximum capabilities of the FM transmitter or the recording device. Exceeding a maximum peak volume level for FM modulation corresponds to exceeding the allowed bandwidth for transmission. In some recording devices, excessive peak volume levels may cause overloading and distortion.

Volume compression may be accomplished by either manual or automatic control. The types of compression used include peak limiters, volume limiters, and volume compressors. A peak limiter limits the peak power to some predetermined level. A volume limiter provides gain reduction based on an

average signal level above a predetermined level. A volume compressor provides gain reduction for only the sustained loud portions of the sound level. Only volume compressors can be correctly compensated for with volume expanders.

For faithful reproduction of the original sound, the volume expander used in the FM receiver or audio amplifier should have the reverse characteristic of the volume compressor used in the FM transmitter or recording device. In general, the basic requirements for either a volume compressor or expander are shown in the block diagram of Fig. 65. In a volume compressor, the

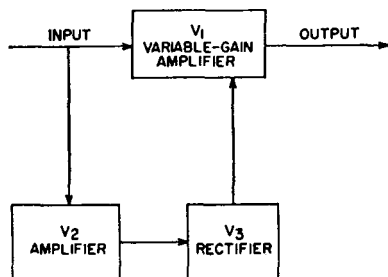

Fig. 65—Block diagram of volume compressor or expander circuit.

variable-gain amplifier V_1 has greater gain for a low-amplitude signal than for a high-amplitude signal; therefore, soft passages are amplified more than loud ones. In an expander, the gain is greater for high-amplitude signals than for low-amplitude signals; therefore, loud passages are amplified more than soft ones and the original amplitude ratio is restored.

In the diagram shown in Fig. 65, the signal to be amplified is applied to V_1 , and a portion of the signal is also applied to V_2 . The amplified output from V_2 is then rectified by V_3 , and applied as a negative (for compressors) or positive (for expanders) bias voltage to V_1 . As this bias voltage varies with variations in signal amplitude, the gain of V_1 also varies to produce the desired compression or expansion of the signal.

Tubes having a large dynamic range provide the best results in volume

compressor or expander applications. An example of this type is the 6BJ6. Push-pull operation is generally desired for the variable-gain amplifier to prevent high distortion and other undesirable effects which may occur in volume compressors and expanders.

Phase Inverters

A phase inverter is a circuit used to provide resistance coupling between the output of a single-tube stage and the input of a push-pull stage. The necessity for a phase inverter arises because the signal-voltage inputs to the grids of a push-pull stage must be 180 degrees out of phase and approximately equal in amplitude with respect to each other. Thus, when the signal voltage input to a push-pull stage swings the grid of one tube in a positive direction, it should swing the grid of the other tube in a negative direction by a similar amount. With transformer coupling between stages, the out-of-phase input voltage to the push-pull stage is supplied by means of the center-tapped secondary. With resistance coupling, the out-of-phase input voltage is obtained by means of the inverter action of a tube.

Fig. 66 shows a push-pull power amplifier, resistance-coupled by means of a phase-inverter circuit to a single-stage triode T_1 . Phase inversion in this circuit is provided by triode T_2 . The output voltage of T_1 is applied to the grid No. 1 of tetrode T_3 . A portion of the output voltage of T_1 is also applied through the resistors R_3 and R_5 to the

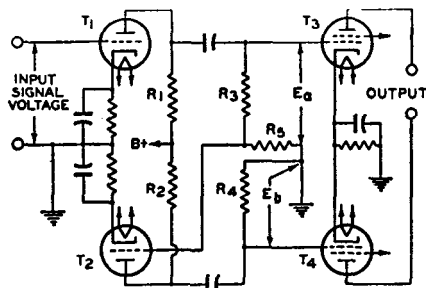

Fig. 66—Push-pull power amplifier resistance-coupled to triode by means of phase inverter.

grid of T_2 . The output voltage of T_2 is applied to the grid No. 1 of tetrode T_1 .

When the output voltage of T_1 swings in the positive direction, the plate current of T_2 increases. This action increases the voltage drop across the plate resistor R_2 and swings the plate of T_2 in the negative direction. Thus, when the output voltage of T_1 swings positive, the output voltage of T_2 swings negative and is, therefore, 180 degrees out of phase with the output voltage of T_1 .

In order to obtain equal voltages at E_a and E_b , $(R_3 + R_5)/R_5$ should equal the voltage gain of T_2 . Under the condition where a twin-type tube or two tubes having the same characteristics are used as T_1 and T_2 , R_4 should be equal to the sum of R_3 and R_5 . The ratio of $R_3 + R_5$ to R_5 should be the same as the voltage gain ratio of T_2 in order to apply the correct value of signal voltage to T_2 . The value of R_5 is, therefore, equal to R_4 divided by the voltage gain of T_2 ; R_3 is equal to R_4 minus R_5 . Values of R_1 , R_2 , R_3 plus R_5 , and R_4 may be taken from the chart in the **Resistance-Coupled Amplifiers** section. In the practical application of this circuit, it is convenient to use a twin-triode tube combining T_1 and T_2 .

Tuned Amplifiers

In radio-frequency (rf) and intermediate-frequency (if) amplifiers, the bandwidth of frequencies to be amplified is usually only a small percentage of the center frequency. Tuned amplifiers are used in these applications to select the desired bandwidth of frequencies and to suppress unwanted frequencies. The selectivity of the amplifier is obtained by means of tuned interstage coupling networks.

The properties of tuned amplifiers depend upon the characteristics of **resonant circuits**. A simple parallel resonant circuit (sometimes called a "tank" because it stores energy) is shown in Fig. 67. For practical purposes the resonant frequency of such a circuit may be considered independent of the resistance R , provided R is small compared to the inductive reactance X_L .

The resonant frequency f_r is then given by

$$f_r = \frac{1}{2\pi\sqrt{LC}}$$

For any given resonant frequency, the product of L and C is a constant; at low frequencies LC is large; at high frequencies it is small.

The **Q (selectivity)** of a parallel resonant circuit alone is the ratio of the current in the tank (I_L or I_C) to the current in the line (I). This unloaded Q , or Q_0 , may be expressed in various ways, for example:

$$Q_0 = \frac{I_C}{I} = \frac{X_L}{R} = \frac{R_p}{X_C}$$

where X_L is the inductive reactance ($= 2\pi fL$), X_C is the capacitive reactance ($= 1/[2\pi fC]$), and R_p is the total impedance of the parallel resonant circuit

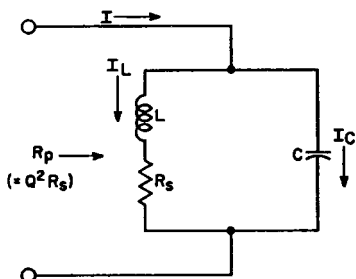

Fig. 67—Simple parallel resonant circuit. (tank) at resonance. The Q varies inversely with the resistance of the inductor. The lower the resistance, the higher the Q and the greater the difference between the tank impedance at frequencies off resonance compared to the tank impedance at the resonant frequency.

The Q of a tuned interstage coupling network also depends upon the impedances of the preceding and following stages. The output impedance of a tube can be considered as consisting of a resistance R_o in parallel with a capacitance C_o , as shown in Fig. 68. Similarly, the input impedance can be considered as consisting of a resistance R_i in parallel with a capacitance C_i . Because the tuned circuit is shunted by both the output impedance of the preceding tube and the input impedance of the following tube, the effective selectivity of the circuit is the loaded Q (or

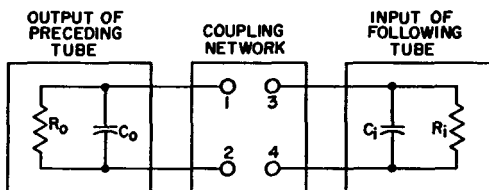

Fig. 68—Equivalent output and input circuits of tubes connected by a coupling network.

Q_{L_i}) based upon the total impedance of the coupled network, as follows:

$$Q_{L_i} = \frac{\left\{ \begin{array}{l} \text{total loading on} \\ \text{coil at resonance} \end{array} \right\}}{X_L \text{ or } X_C}$$

The capacitances C_o and C_i in Fig. 68 are usually considered as part of the coupling network. For example, if the required capacitance between terminals 1 and 2 of the coupling network is calculated to be 500 picofarads and the value of C_o is 10 picofarads, a capacitor of 490 picofarads is used between terminals 1 and 2 so that the total capacitance is 500 picofarads. The same method is used to allow for the capacitance C_i at terminals 3 and 4.

When a tuned resonant circuit in the primary winding of a transformer is coupled to the nonresonant secondary winding of the transformer, as shown in Fig. 69, the effect of the input impedance of the following stage on the Q of the tuned circuit can be determined by considering the values reflected (or referred) to the primary circuit by

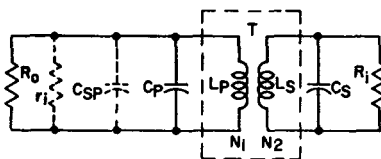

Fig. 69—Equivalent circuit for transformer-coupling network having tuned primary winding.

transformer action. The reflected resistance r_i is equal to the resistance R_i in the secondary circuit times the square of the effective turns ratio between the primary and secondary windings of the transformer T :

$$r_i = R_i (N_1/N_2)^2$$

where N_1/N_2 represents the electrical turns ratio between the primary winding

and the secondary winding of T . If there is capacitance in the secondary circuit (C_s), it is reflected to the primary circuit as a capacitance C_{sp} , and is given by

$$C_{sp} = C_p \div (N_1/N_2)^2$$

The loaded Q , or Q_{L_i} , is then calculated on the basis of the inductance L_p , the total shunt resistance (R_o plus r_i plus the tuned-circuit impedance $Z_t = Q_o X_c = Q_o X_L$), and the total capacitance ($C_p + C_{sp}$) in the tuned circuit.

Fig. 70 shows a coupling network which consists of a single-tuned circuit using mutual inductive coupling. The

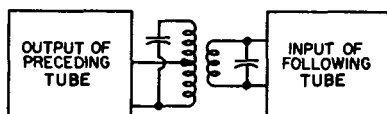

Fig. 70—Equivalent circuit for transformer-coupling network using inductive coupling.

capacitance C_i includes the effects of both the output capacitance of the preceding tube and the input capacitance of the following tube (referred to the primary of transformer T_1). The bandwidth of a single-tuned transformer is determined by the half-power points on the resonance curve (-3 dB or 0.707 down from the maximum). Under these conditions, the band pass Δf is equal to the ratio of the center or resonant frequency f_r divided by the loaded (effective) Q of the circuit, as follows:

$$\Delta f = f_r/Q_L$$

In high-frequency tuned amplifiers, where the input impedance is typically low, mutual inductive coupling may be impracticable because of the small number of turns in the secondary winding. It is extremely difficult in practice to construct a fractional part of a turn. In such cases, capacitance coupling may

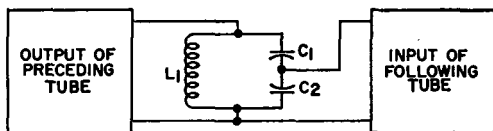

Fig. 71—Single-tuned coupling network using capacitive division.

be used, as shown in Fig. 71. This arrangement, which is also called **capacitive division**, is similar to tapping down on a coil at or near resonance. Impedance transformation in this network is determined by the ratio between capacitors C_1 and C_2 . Capacitor C_1 is normally much smaller than C_2 ; thus the capacitive reactance X_{C1} is normally much larger than X_{C2} . Provided the input resistance of the following tube is much greater than X_{C2} , the effective turns ratio from the top of the coil to the input of the following tube is $(C_1 + C_2)/C_1$. The total capacitance C_t across the inductance L is given by

$$C_t = \frac{C_1 C_2}{C_1 + C_2}$$

The resonant frequency f_r is then given by

$$f_r = \frac{1}{2\pi\sqrt{L_t C_t}}$$

Double-tuned interstage coupling networks are often used in preference to single-tuned networks to provide flatter frequency response within the pass band, a sharper drop in response immediately adjacent to the ends of the pass band, or more attenuation at frequencies far removed from resonance. In synchronous double-tuned networks, both the resonant circuit in the input of the coupling network and the resonant circuit in the output are tuned to the same resonant frequency. In "stagger-tuned" networks, the two resonant circuits are tuned to slightly different resonant frequencies to provide a more rectangular band pass with sharper selectivity at the ends of the pass band. Double-tuned or stagger-tuned networks may use capacitive, inductive, or mutual inductance coupling, or any combination of the three.

Television Tuners

The vhf tuner of a television receiver selects the desired frequency

channel in the range from 55 to 216 MHz, amplifies it, and converts it to a lower intermediate frequency. These functions are accomplished in rf-amplifier, mixer, and local-oscillator stages employing tube types that are designed specifically for these applications. The rf-amplifier stage uses a high-transconductance tube that has small dimensions to maintain low interelectrode capacitances, particularly between grid and plate. The mixer and oscillator stages usually employ a dual-unit triode-pentode unit and a medium-mu triode unit.

Fig. 72 shows a simplified schematic diagram of a typical vhf television tuner. The balun converts the 300-ohm balanced antenna impedance to an unbalanced impedance of 75 ohms. The high-pass filter eliminates lower-frequency interference signals. The tuner is set to the desired frequency by simultaneous adjustment of the inductances indicated by the several sets of arrows in Fig. 72. The inductances are either replaced completely or incremental amounts of inductance are added as the tuner is switched from high frequencies to lower frequencies. Some tuners use a combination of the two methods.

Because **noise** generated in the first amplifier stage is often the controlling factor in determining the over-all sensitivity of a radio or television receiver, the "front end" is designed with special attention to both gain and noise characteristics. The input circuit of an amplifier inherently contains some thermal noise contributed by the resistive elements in the input device. When an input signal is amplified, therefore, the thermal noise generated in the input circuit is also amplified. If the ratio of signal power to noise power (**signal-to-noise ratio**, S/N) is the same in the output circuit as in the input circuit, the amplifier is considered to be "noise-

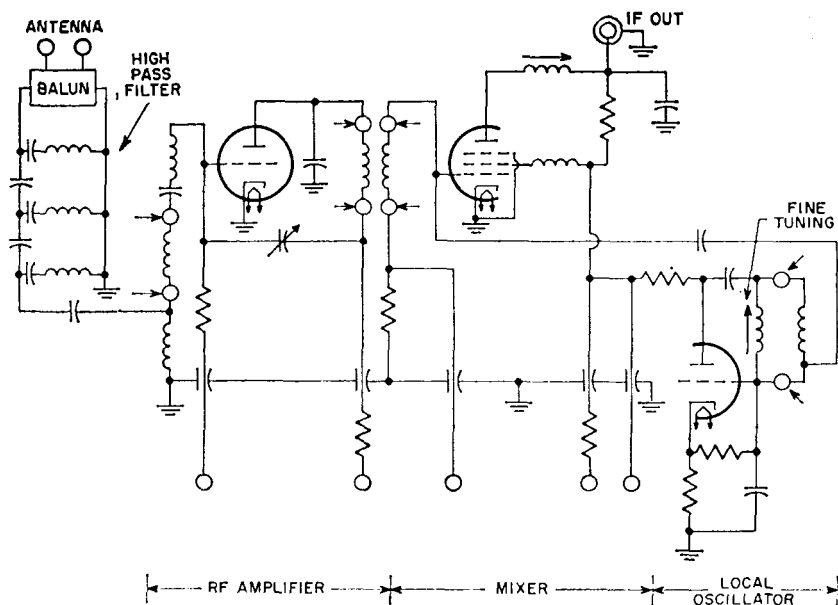

Fig. 72—Simplified schematic of typical vhf television tuner.

less," and is said to have a noise figure of unity, or zero dB.

In practical circuits, however, all amplifier stages generate a certain amount of noise as a result of thermal agitation of electrons in resistors and other components, minute variations in the cathode emission of tubes (shot effect), and minute grid currents in the amplifier tubes. As a result, the ratio of signal power to noise power is inevitably impaired during amplification. A measure of the degree of impairment is called the **noise figure** (NF) of the amplifier, and is expressed as the ratio of signal power to noise power at the input (S_1/N_1) divided by the ratio of signal power to noise power at the output (S_o/N_o), as follows:

$$NF = \frac{(S_1/N_1)}{(S_o/N_o)}$$

The noise figure in decibels (dB) is equal to ten times the logarithm of this power ratio. For example, a one-dB noise figure in an amplifier decreases the signal-to-noise ratio by a factor of 1.26, a 3-dB noise figure by a factor of 2, a 10-dB noise figure by a factor

of 10, and a 20-dB noise figure by a factor of 100.

The over-all noise figure of a receiver is affected by the total number of stages, as shown by the following relationship:

$$NF_{\text{receiver}} = NF_1 + \frac{(NF_2 + 1)}{G_1} + \frac{(NF_3 + 1)}{G_1 G_2} \dots$$

where G represents power gain and the subscripts indicate the number of each stage. This relationship indicates that the contribution of the second-stage noise factor to that of the over-all receiver is reduced by the gain of the first stage. Therefore, it is important that the rf amplifier have enough gain to make the effect of the second stage negligible. The third stage will then have even less effect. The maximum available power gain G of an rf stage is given by

$$G = \frac{g_m^2 R_{in} R_{out}}{4}$$

For maximum gain, therefore, the rf-amplifier tube should have high transconductance and high input and output impedances. At frequencies in the vhf

television band, the input resistance is small enough to affect the gain. As mentioned previously, the rf tube is designed to have low interelectrode capacitances, small interelectrode spacings, and low lead inductances (particularly the cathode lead).

The gain of the rf stage must be reduced as the incoming-signal amplitude changes to prevent overload distortion in the following stages. As the signal amplitude increases, an automatic-gain-control (agc) circuit biases the rf tube to decrease its gain. The rf tube usually employs a semiremote-cutoff grid to reduce cross-modulation distortion.

Either a triode or a pentode can be used in the **rf-amplifier** stage of tuner input circuits of vhf television receivers. Such stages are required to amplify signals ranging from 55 to 216 MHz and having a bandwidth of 4.5 MHz (the tuner is usually aligned for a bandwidth of 6 MHz to assure complete coverage of the band). In early rf tuners, pentodes rather than triodes were used because the grid-plate capacitance of triodes created stability problems. However, the use of twin triodes in direct-coupled cathode-drive circuits makes it possible to obtain stable operation along with the low-noise characteristics of triodes.

Pentodes or tetrodes do not provide the useful sensitivity of triodes because of the "partition noise" introduced by the screen grid. The direct-coupled cathode-drive circuit provides both the gain and the stability capabilities of the pentode, as well as the advantages of a low-noise triode input stage. Because the cathode-drive stage provides a low-impedance load to the grounded-cathode stage, the gain of the latter stage is very low and there is no necessity for neutralizing the grid-plate capacitance. An interstage impedance, usually an inductance in series with the plate of the first stage and the cathode of the second stage, is often used at higher frequencies to provide a degree of impedance matching between the units. The cathode-drive portion of the circuit is matched to the input net-

work and provides most of the stage gain. Because the feedback path of the cathode-drive circuit is the plate-cathode capacitance, which in most cases is very small, excellent isolation is provided between the antenna and the local oscillator.

Development of single triodes having low grid-plate capacitance, such as the 6BN4A has made possible the design of neutralized triode rf circuits. Tubes such as the 6GK5 and 6CW4 are specially designed to minimize grid-plate capacitance to permit easier neutralization of a grounded-cathode circuit over the wide frequency band. Bridge-neutralized rf-amplifier stages are widely used in television tuners; in this arrangement, a portion of the output signal is returned to the grid out of phase with the feedback signal from the grid-plate capacitance. This circuit provides excellent gain and noise performance with stable operation across the band.

The **mixer** stage of a vhf tuner usually employs a pentode tube, or the pentode unit of a triode-pentode tube. Although triodes such as the 6J6A were used as mixers in early receivers, they have been replaced by pentodes because the higher output impedance of a pentode provides a higher mixer gain than can be obtained with a triode.

The amplified signal from the rf stage in Fig. 72 is applied to the mixer grid along with a local-oscillator signal of much larger amplitude. The local-oscillator signal varies the mixer grid voltage from cutoff into the grid-current region. This signal develops a grid-resistor bias, called the **injection voltage**, which is a measure of the local-oscillator voltage. Because the transfer curve of the mixer tube is nonlinear, mixing action between the rf signal and the local-oscillator signal produces sum and difference frequencies. The output circuit of the mixer is tuned to the difference frequency (about 44 MHz) and rejects all other frequencies. This signal is then fed to the intermediate-frequency amplifier.

The mixer gain is a function of the amplitude of the local-oscillator

signal. The gain has a broad maximum over a range of injection voltages from -2.5 to -5.0 volts for conventional-grid mixers and slightly lower for frame-grid mixers. Good impedance matching between the rf-amplifier plate and the mixer grid, consistent with bandpass requirements, is important to achieve maximum signal power transfer. A slight amount of regeneration is provided by a small screen-grid inductance. This regeneration effectively increases the mixer-grid input impedance and thus improves power gain.

The **local-oscillator** stage shown in Fig. 72 is a Colpitts type in which the tuned circuit is located between the grid and plate and the feedback path is through the tube interelectrode capacitances. A large signal is developed in the local oscillator and coupled loosely to the mixer grid to minimize the effects of changes in the mixer input on the frequency of oscillation. The circuit is designed to keep frequency shift within a very narrow range with supply-voltage and temperature changes. Fine tuning is provided by a variable inductance or capacitance across the tuned circuit. Tubes commonly used in local-oscillator and mixer circuits are the 6EA8, 6KZ8, and 6KE8.

Television IF Amplifiers

The intermediate-frequency (if) amplifier stages in a television receiver provide the additional gain required to bring the signal level to an amplitude suitable for final detection. A constant peak signal of about three to five volts is required at the input to the detector. The mixer output signal is passed through two or three stages of amplification to attain this level. High-transconductance pentodes having low grid-No.1-to-plate capacitances are normally used in if amplifiers. The coupling circuits are usually tuned transformers which may be single- or double-tuned. The transformers are either synchronously (same frequency) tuned or stagger-tuned, depending on circuit requirements. The over-all bandwidth varies from a maximum of 3.58 MHz at the 6-dB points for color receivers to

values in the order of 2.0 to 2.5 MHz for the most inexpensive receivers. An expression for the figure of merit for a single tuned if-amplifier tube is the gain-bandwidth product $G \times B$, which is given by

$$G \times B = \frac{g_m}{2 \pi C}$$

where C is the total tuning capacitance. This relationship again demonstrates the need for high transconductance and low interelectrode capacitance.

The first stage (or first two stages in the case of a three-stage if) is gain-controlled like the rf amplifier. However, the bias applied to the if-amplifier tube varies the input resistance and capacitance of the tube and thus detunes the circuit. It is important for proper reception to maintain the frequency response of the if stages constant, particularly in the case of the color receiver. Therefore, a small unbypassed cathode resistor is used which provides degenerative feedback to minimize the effect of bias changes. In addition, the effects on input impedance caused by the grid-plate capacitance are reduced by use of a partial bypass capacitor at the screen grid to provide neutralization of the grid-to-plate capacitance.

Tubes used in the gain-controlled stages of the if amplifier have remote- or semiremote-cutoff characteristics to reduce cross-modulation or intermodulation interference. Tube types commonly used in this application include the 6BZ6, 6GM6, 6JH6, 6JD6A, and 6KT6.

The last if-amplifier stage is a relatively-large-signal amplifier. For this reason, the tube must be biased so that it will operate over a region of linear operation for large voltage excursions. Because such a quiescent operating point provides a transconductance somewhat below the maximum value for the tube, the selection of the operating point involves a compromise between signal-handling capacity and gain. For purposes of linearity, the final if-amplifier stage is not gain-controlled, and operates with the cathode bypassed to ground. Because fixed bias

is used, a sharp-cutoff tube is used to provide higher transconductance than could be obtained with an equivalent remote- or semiremote-cutoff tube. Examples of types used in this stage are the 6EW6 and 6JC6A.

Wideband (Video) Amplifiers

In some applications, it is necessary for a circuit to amplify signals ranging from very low frequencies (several hertz) to high frequencies (tens of megahertz) with a minimum of frequency and time-delay distortion. For example, very exacting requirements are demanded for such applications as television camera chains, ac voltmeters, and vertical amplifiers for oscilloscopes. In response to these demands, circuit compensation techniques have been developed to minimize the amplitude and time-delay variation as the upper or lower frequency limits of the amplifier are approached.

The need for such compensation is evident when many identical stages of amplification are employed. If ten cascaded stages are used, a variation of 0.3 dB per stage results in a total variation of 3 dB. In an uncompensated amplifier, this total variation occurs two octaves (a frequency ratio of four) prior to the half-power point. Because two octaves are lost from both the high and low frequencies, the bandwidth of ten cascaded uncompensated amplifies stages is only one-sixteenth that of a single amplifier stage. Fig. 73 shows the amplitude response characteristics of various numbers of identical

uncompensated amplifiers.

In general, the output of an amplifier may be represented by a current generator i_{out} and a load resistance R_L , as shown in Fig. 74(a). Because the signal current is shunted by various capacitances at high frequencies, as shown in Fig. 74(b), there is a loss in gain at these frequencies. If an inductor L is placed in series with the load resistor R_L , as shown in Fig. 74(c), a low-Q circuit is formed which somewhat suppresses the capacitive loading. This method of gain compensation, called **shunt peaking**, can be effective for improving high-frequency response. Fig. 74 shows the frequency response for the circuits in Fig. 74(a), (b), and (c). If the inductor L in Fig. 74(c) is made **self-resonant** approximately one octave above the 3-dB frequency of the circuit of Fig. 74(b), the amplifier response is extended by about another 30 per cent.

If the stray capacitance C shown in Fig. 74(b) is broken into two parts C' and C'' and an inductor L_1 is placed between them, a heavily damped form of series resonance may be employed for further improvement. This form of compensation, called **series peaking**, is shown in Fig. 75(a). If C' and C'' are within a factor of two of each other, series peaking produces an appreciable improvement in frequency response as compared to shunt peaking. A more complex form of compensation embodying both self-resonant shunt peaking and series peaking is shown in Fig. 75(b).

The effects of various high-fre-

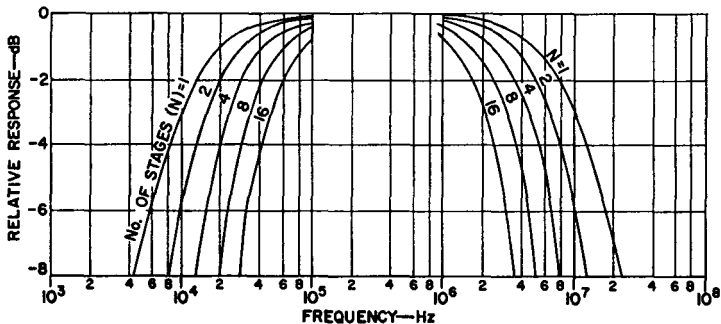

Fig. 73—Amplitude response characteristics of various numbers (N) of identical uncompensated amplifiers.

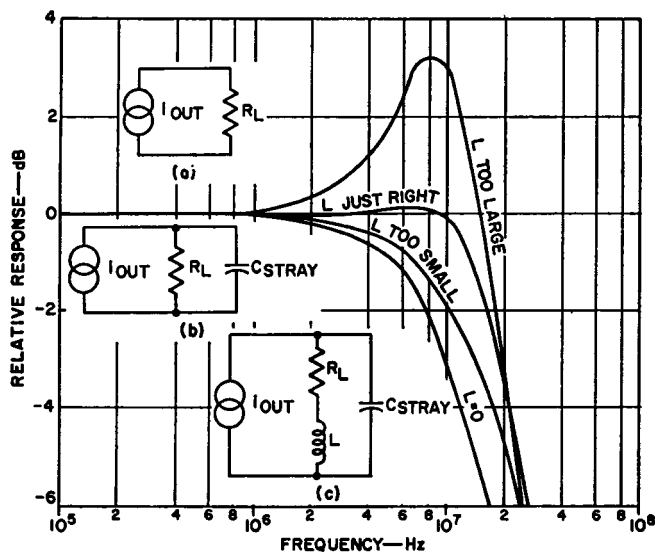

Fig. 74—Equivalent circuits and frequency response of uncompensated and shunt-peaked amplifiers.

frequency compensation systems can be demonstrated by consideration of an amplifier consisting of three identical stages. If each of the three stages is down 3 dB at 1 MHz, and if a total gain variation of plus 1 dB and minus 3 dB is allowed, the bandwidth of the amplifier is 0.5 MHz without compensation. Shunt peaking raises the bandwidth to 1.3 MHz. Self-resonant shunt

width of approximately 2.8 MHz. If the capacitance is perfectly distributed, and if an infinitely complex network of shunt and series peaking is employed, the ultimate capability is about 4 MHz.

The frequency response of a wide-band amplifier is influenced greatly by variations in component values due to temperature effects, variation of tube parameters with voltage and current (normal large-signal excursions), changes of stray capacitance due to relocated lead wires, or other variations. A change of 20 per cent in any of the critical parameters can cause a change of 0.7 dB in gain per stage over the last half-octave of the response for the most simple case of shunt peaking. As the bandwidth is extended by more complex peaking, a circuit becomes substantially more critical. (Measurement probes generally alter circuit performance because of their capacitance; this effect should be considered during frequency-response measurements.)

peaking raises it to 1.5 MHz. An infinitely complicated network of shunt-peaking techniques could raise it to 2 MHz. If the distribution of capacitance permits it, series peaking alone can provide a bandwidth of about 2 MHz, while a combination of shunt and series peaking can provide a band-

In the design of wideband amplifiers using many stages of amplification, it is necessary to consider time-delay variations as well as amplitude variation. When feedback capacitance

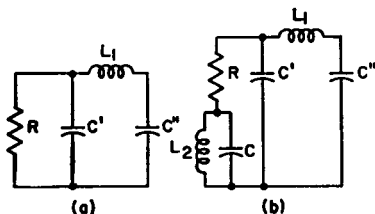

Fig. 75—Circuits using (a) series peaking, and (b) both self-resonant shunt peaking and series peaking.

is a major contributor to response limitation, the more complex compensating networks may produce severe ringing or even sustained oscillation. If feedback capacitance is treated as input capacitance produced by the Miller effect, the added input capacitance C_r' caused by the feedback capacitor C_r is given by

$$C_r' = C_r (1 - VG)$$

where VG is the input-to-output voltage gain. The gain VG , however, has a phase angle that varies with frequency. The phase angle is 180 degrees at low frequencies, but may lead or lag this value at high frequencies; the magnitude of VG then also varies. In the design of very wideband amplifiers (20 MHz or more), the phase of the transconductance g_m must be considered.

The video amplifier stage in a television receiver usually employs a pentode-type tube specially designed to amplify the wide band of frequencies contained in the video signal and, at the same time, to provide high gain per stage. Pentodes are more useful than triodes in such stages because they have high transconductance (to provide high gain) together with low input and output interelectrode capacitances (to permit the broadband requirements to be satisfied). An approximate "figure of merit" for a particular tube for this application can be determined from the ratio of its transconductance, g_m , to the sum of its input and output capacitances, C_{in} and C_{out} , as follows:

$$\text{Figure of Merit} = \frac{g_m}{C_{in} + C_{out}}$$

Typical values for this figure are in the order of 500×10^6 or greater.

A typical video amplifier stage, such as that shown in Fig. 76, is connected between the second detector of the television receiver and the picture tube. The contrast control, R_1 , in this circuit controls the gain of the video amplifier tube. The inductance, L_2 , in series with the load resistor, R_L , maintains the plate load impedance at a relatively constant value with increasing

frequency. The inductance L_1 isolates the output capacitance of the tube so that only stray capacitance is placed

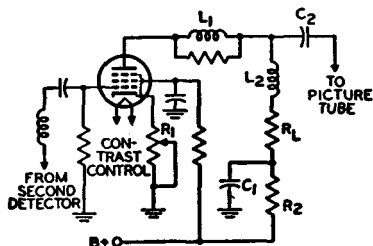

Fig. 76—Typical video amplifier stage.

across the load. As a result, a higher-value load resistor is used to provide higher gain without affecting frequency response or phase relations. The decoupling circuit, C_1R_2 , is used to improve the low-frequency response. Tubes used as video amplifiers include types 6CL6 and 12BY7A, or the pentode sections of types 6AW8A and 6AN8A.

The luminance amplifier in a color-television receiver is a conventional video amplifier having a bandwidth of approximately 3.5 MHz. In a color receiver, the portion of the output of the second detector which lies within the frequency band from approximately 2.4 to 4.5 MHz is fed to a bandpass amplifier, as shown in the block diagram in Fig. 77. The color

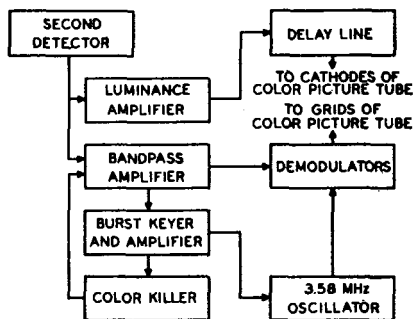

Fig. 77—Block diagram of video-amplifier section of color television receiver.

synchronizing signal, or "burst," contained in this signal may then be fed to a "burst-keyer" tube. At the same

time, a delayed horizontal pulse may be applied to the keyer tube. The output of the keyer tube is applied to the burst amplifier tube and the signal is then fed to the 3.58-MHz oscillator and to the "color-killer" stage.

The color killer applies a bias voltage to the bandpass amplifier in the absence of burst so that the color section, or **chrominance** channel, of the receiver remains inoperative during black-and-white broadcasts. A threshold control varies the bias and controls the burst level at which the killer stage operates.

The output of the 3.58-MHz oscillator and the output of the bandpass amplifier are fed into phase and amplitude demodulator circuits. The output of each demodulator circuit is an electrical representation of a color-difference signal, *i.e.*, an actual color signal minus the black-and-white, or luminance, signal. The two color-difference signals are combined to produce the third color-difference signal; each of the three signals then represents one of the primary colors.

The three color-difference signals are usually applied to the grids of the three electron guns of the color picture tube, in which case the black-and-white signal from the luminance amplifier may be applied simultaneously to the cathodes. The chrominance and luminance signals then combine to produce the color picture. In the absence of transmitted color information, the chrominance channel is cut off by the color killer, as described above, and only the luminance signal is applied to the picture tube, producing a black-and-white picture.

TV Scanning, Sync, and Deflection

For reproduction of a transmitted picture in a television receiver, the

face of a cathode-ray tube is scanned with an electron beam while the intensity of the beam is varied to control the emitted light at the phosphor screen. The scanning is synchronized with a scanned image at the TV transmitter, and the black-through-white picture areas of the scanned image are converted into an electrical signal that controls the intensity of the electron beam in the picture tube at the receiver.

Scanning Fundamentals

The scanning procedure used in the United States employs horizontal linear scanning in an odd-line interlaced pattern. The standard scanning pattern for television systems includes a total of 525 horizontal scanning lines in a rectangular frame having an aspect ratio of 4 to 3. The frames are repeated at a rate of 30 per second, with two fields interlaced in each frame. The first field in each frame consists of all odd-number scanning lines, and the second field in each frame consists of all even-number scanning lines. The field repetition rate is thus 60 per second, and the vertical scanning rate is 60 Hz.

The geometry of the standard odd-line interlaced scanning pattern is illustrated in Fig. 78. The scanning beam starts at the upper left corner of the frame at point A, and sweeps across the frame with uniform velocity to cover all the picture elements in one horizontal line. At the end of each trace, the beam is rapidly returned to the left side of the frame, as shown by the dashed line, to begin the next horizontal line. The horizontal lines slope downward in the direction of scanning because the vertical deflecting signal simultaneously produces a verti-

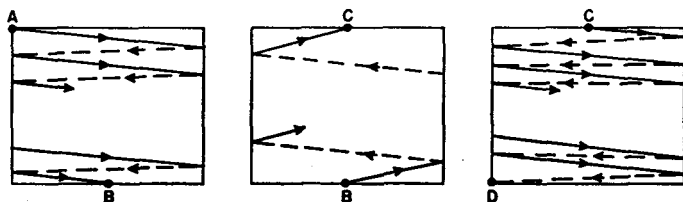

Fig. 78—The odd-line interlaced scanning procedure.

cal scanning motion, which is very slow compared with the horizontal scanning speed. The slope of the horizontal line trace from left to right is greater than the slope of the retrace from right to left because the shorter time of the retrace does not allow as much time for vertical deflection of the beam. Thus, the beam is continuously and slowly deflected downward as it scans the horizontal lines, and its position is successively lower as the horizontal scanning proceeds.

At the bottom of the field, the vertical retrace begins, and the beam is brought back to the top of the frame to begin the second or even-number field. The vertical "flyback" time is very fast compared to the trace, but is slow compared to the horizontal scanning speed; therefore, some horizontal lines are produced during the vertical flyback.

All odd-number fields begin at point A in Fig. 78 and are the same. All even-number fields begin at point C and are the same. Because the beginning of the even-field scanning at C is on the same horizontal level as A, with a separation of one-half line, and the slope of all lines is the same, the even-number lines in the even fields fall exactly between the odd-number lines in the odd field.

Sync

In addition to picture information, the composite video signal from the video detector of a television receiver contains timing pulses to assure that the picture is produced on the faceplate of the picture tube at the right instant and in the right location. These pulses, which are called sync pulses,

control the horizontal and vertical scanning generators of the receiver.

Fig. 79 shows a portion of the detected video signal. When the picture is bright, the amplitude of the signal is low. Successively deeper grays are represented by higher amplitudes until, at the "blanking level" shown in the diagram, the amplitude represents a complete absence of light. This "black level" is held constant at a value equal to 75 per cent of the maximum amplitude of the signal during transmission. The remaining 25 per cent of the signal amplitude is used for synchronization information. Portions of the signal in this region (above the black level) cannot produce light.

In the transmission of a television picture, the camera becomes inactive at the conclusion of each horizontal line and no picture information is transmitted while the scanning beam is retracing to the beginning of the next line. The scanning beam of the receiver is maintained at the black level during this retrace interval by means of the blanking pulse shown in Fig. 79. Immediately after the beginning of the blanking period, the signal amplitude rises further above the black level to provide a horizontal-synchronization pulse that initiates the action of the horizontal scanning generator. When the bottom line of the picture is reached, a similar vertical-synchronization pulse initiates the action of the vertical scanning generator to move the scanning spot back to the top of the pattern.

The sync pulses in the composite video signal may be separated from the video information in the output of the second or video detector by means of

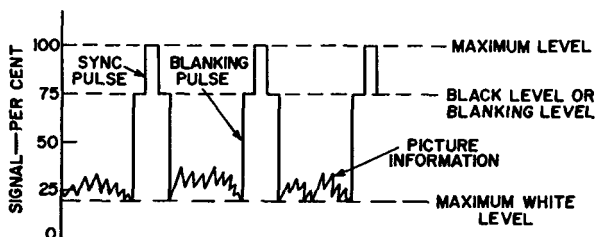

Fig. 79—Detected video signal.

the triode circuit shown in Fig. 80. In this circuit, the time constant of the network R_1C_1 is long with respect to the interval between pulses. During each pulse, the grid is driven positive and draws current, thereby charging capacitor C_1 . Consequently, the grid develops a bias which is slightly greater

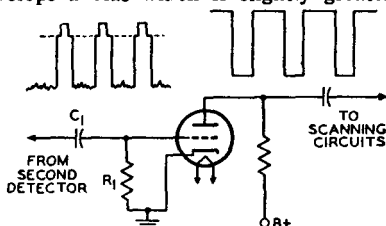

Fig. 80—Sync-separator circuit.

than the cutoff voltage of the tube. Because plate current flows only during the sync-pulse period, only the amplified pulse appears in the output. This sync-separator stage discriminates against the video information. Because the bias developed on the grid is proportional to the strength of the incoming signal, the circuit also has the advantage of being relatively independent of signal fluctuations.

After the synchronizing signals are separated from the composite video signal, it is necessary to filter out the horizontal and vertical sync signals so that each can be applied to its respective deflection generator. This filtering is accomplished by RC circuits designed to filter out all but the desired synchronizing signals. Although the horizontal, vertical, and equalizing pulses are all rectangular pulses of the same amplitude, they differ in frequency and pulse width, as shown in Fig. 81. The horizontal sync pulses have a repetition rate of 15,750 per second (one for

each horizontal line) and a pulse width of 5.1 microseconds. The equalizing pulses have a width approximately half the horizontal pulse width, and a repetition rate of 31,500 per second; they occur at half-line intervals, with six pulses immediately preceding and six following the vertical synchronizing pulse. The vertical pulse is repeated at a rate of 60 per second (one for each field), and has a width of approximately 190 microseconds. The serrations in the vertical pulse occur at half-line intervals, dividing the complete pulse into six individual pulses that provide horizontal synchronization during the vertical retrace. (Although the picture is blanked out during the vertical retrace time, it is necessary to keep the horizontal scanning generator synchronized.)

All the pulses described above are produced at the transmitter by the synchronizing-pulse generator; their waveshapes and spacings are held within very close tolerances to provide the required synchronization of receiver and transmitter scanning.

The horizontal sync signals are separated from the total sync in a differentiating circuit that has a short time constant compared to the width of the horizontal pulses. When the total sync signal is applied to the differentiating circuit shown in Fig. 82, the capacitor charges completely very soon after the leading edge of each pulse, and remains charged for a period of time equal to practically the entire pulse width. When the applied voltage is removed at the time corresponding to the trailing edge of each pulse, the capacitor discharges completely within a very short time. As a result, a positive peak of voltage is obtained for

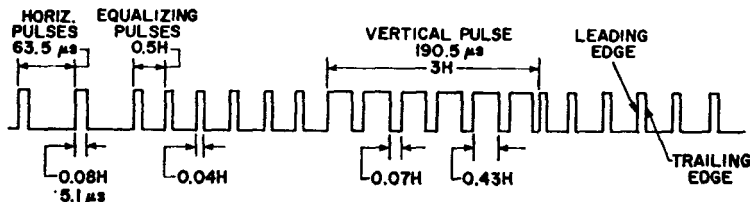

Fig. 81—Waveform of TV synchronizing pulses (H = horizontal line period of $1/15,750$ seconds, or $63.5 \mu s$).

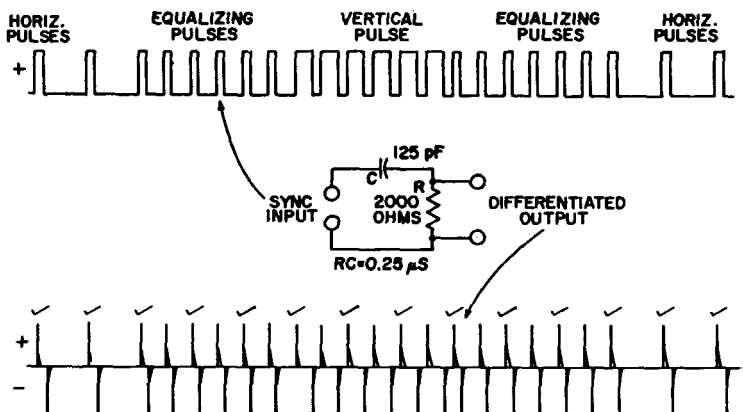

Fig. 82—Separation of the horizontal sync signals from the total sync by a differentiating circuit.

each leading edge and a negative peak for the trailing edge of every pulse. One polarity is produced by the charging current for the leading edge of the applied pulse, and the opposite polarity is obtained from the discharge current corresponding to the trailing edge of the pulse.

As mentioned above, the serrations in the vertical pulse are inserted to provide the differentiated output needed to synchronize the horizontal scanning generator during the time of vertical synchronization. During the vertical blanking period, many more voltage peaks are available than are necessary for horizontal synchronization (only one pulse is used for each horizontal line period). The check marks above the differentiated output in Fig. 82 indicate the voltage peaks used to synchronize the horizontal deflection generator for one field. Because the sync system is made sensitive only to positive pulses occurring at approximately the right horizontal timing, the negative sync pulses and alternate differentiated positive pulses produced by the equalizing pulses and the serrated vertical information have no effect on horizontal timing. It can be seen that although the total sync signal (including vertical synchronizing information) is applied to the circuit of Fig. 82, only horizontal synchronization information appears at the output.

The vertical sync signal is separated from the total sync in an integrating circuit which has a time constant that is long compared with the duration of the 5-microsecond horizontal pulses, but short compared with the 190-microsecond vertical pulse width. Fig. 83 shows the general circuit configuration

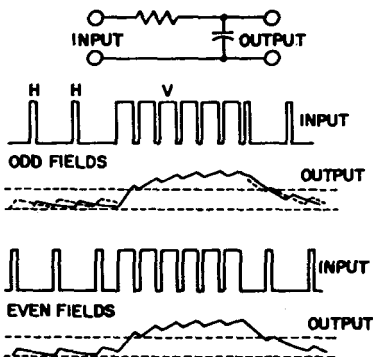

Fig. 83—Separation of vertical sync signals from the total sync for odd and even fields with no equalizing pulses. (Dashed line indicates triggering level for vertical scanning generator.)

used, together with the input and output signals for both odd and even fields. The period between horizontal pulses, when no voltage is applied to the RC circuit, is so much longer than the horizontal pulse width that the capacitor has time to discharge almost down to

zero. When the vertical pulse is applied, however, the integrated voltage across the capacitor builds up to the value required for triggering the vertical scanning generator. This integrated voltage across the capacitor reaches its maximum amplitude at the end of the vertical pulse, and then declines practically to zero, producing a pulse of the triangular wave shape shown for the complete vertical synchronizing pulse. Although the total sync signal (including horizontal information) is applied to the circuit of Fig. 83, therefore, only vertical synchronization information appears at the output.

The vertical synchronizing pulses are repeated in the total sync signal at the field frequency of 60 per second. Therefore, the integrated output voltage across the capacitor of the RC circuit of Fig. 83 can be coupled to the vertical scanning generator to provide vertical synchronization. The six equalizing pulses immediately preceding and following the vertical pulse improve the accuracy of the vertical synchronization for better interlacing. The equalizing pulses that precede the vertical pulses make the average value of applied voltage more nearly the same for even and odd fields, so that the integrated voltage across the capacitor adjusts to practically equal values for the two fields before the vertical pulse begins. The equalizing pulses that follow the vertical pulse minimize any

difference in the trailing edge of the vertical synchronizing signal for even and odd fields.

In fringe areas, two conditions complicate the process of sync separation. First, the incoming signal available at the antenna is weak and susceptible to fading and other variations; second, the receiver is operating at or near maximum gain, which makes it extremely susceptible to interference from pulse-type noise generated by certain types of electrical equipment, ignition systems, switches, or the like. Some type of **noise-immunity** provision is almost essential for acceptable performance. Noise may be reduced or eliminated from the sync and agc circuits by gating or by a combination of gating, inversion, and cancellation. An example, of the latter method is shown in Fig. 84. In this circuit the 6GY6, which has two independent control grids, serves the dual function of agc amplifier and noise inverter. Because the sync tips of the video signal at grid No. 1 of the 6GY6 drive the tube near its cutoff region, any noise signal extending above the tip level will appear inverted across the grid-No.2 load resistor R. This inverted noise signal is re-combined with the video signal and fed to the sync separator at point "A" in Fig. 84, where noise cancellation takes place. This process leaves the sync pulses relatively free of disturbing noise and results in a stable picture.

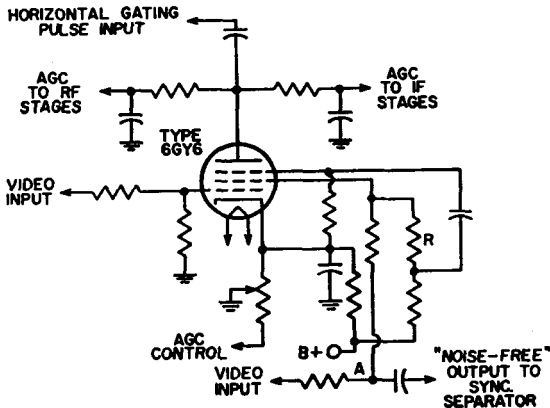

Fig. 84—Typical noise-cancellation circuit.

To prevent reduction of receiver gain due to the effect of noise on the agc amplifier, a portion of the inverted noise signal is fed to the second control grid, grid No.3, of the 6GY6 to cut off or gate the agc amplifier when a noise pulse occurs.

Horizontal Deflection

In the horizontal-deflection stages of a television receiver, a current that varies linearly with time and has a sufficient peak-to-peak amplitude must be passed through the horizontal-deflection-yoke winding to develop a magnetic field adequate to deflect the electron beam of the television picture tube. (This type of deflection is different from that used in a cathode-ray oscilloscope, where the beam is deflected electrostatically.) After the beam is deflected completely across the face of the picture tube, it must be returned very quickly to its starting point. (As explained previously, the beam is extinguished during this retrace by the blanking pulse incorporated in the composite video signal, or in some cases by additional external blanking derived from the horizontal-deflection system.)

The simplest form of a deflection circuit is shown in Fig. 85. In this circuit, the yoke impedance L is assumed to be a perfect inductor. When the



Fig. 85—Simplest form of deflection circuit.

switch is closed, the yoke current starts from zero and increases linearly. At any time t , the current i is equal to Et/L , where E is the applied voltage. When the switch is opened at a later time t_1 , the current instantly drops from a value of Et_1/L to zero.

Although the basic circuit of Fig. 85 crudely approaches the requirements for deflection, it presents some obvious problems and limitations. The voltage across the switch becomes extremely

high, theoretically approaching infinity. In addition, if very little of the total time is spent at zero current, the circuit would require a tremendous amount of dc power. Furthermore, the operation of the switch would be rather critical with regard to both its opening and its closing. Finally, because the deflection field would be phased in only one direction, the beam would have to be centered at the extreme left of the screen for zero yoke current.

If a capacitor is placed across the switch, as shown in Fig. 86, the yoke

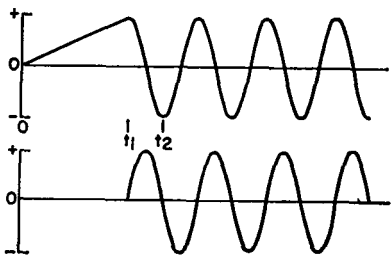
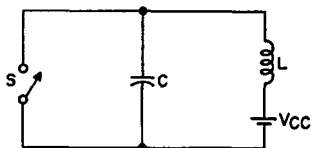

Fig. 86—Addition of capacitor to permit flyback ringing, and yoke-current (upper) and switch-voltage (lower) waveforms.

current still increases linearly when the switch is closed at time $t = 0$. However, when the switch is opened at time $t = t_1$, a tuned circuit is formed by the parallel combination of L and C . The resulting yoke currents and switch voltages are then as shown in Fig. 86. The current is at a maximum when the voltage equals zero, and the voltage is at a maximum when the current equals zero. If it is assumed that there are no losses, the ringing frequency f_{osc} is equal to $1/(2\pi\sqrt{LC})$.

If the switch is closed again at any time the capacitor voltage is not equal to zero, an infinite switch current flows as a result of the capacitive discharge. However, if the switch is closed at the precise moment t_2 that the capacitor voltage equals zero, the capacitor cur-

rent effortlessly transfers to the switch, and a new transient condition results. Fig. 87 shows the yoke-current and switch-voltage waveforms for this new condition.

If the switch is again opened at t_1 , closed at t_2 , and so on, the desired

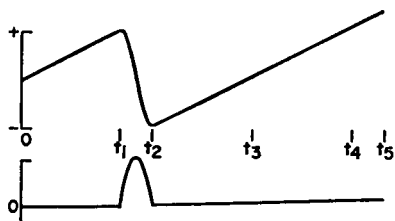

Fig. 87—Yoke-current (upper) and switch-voltage (lower) waveforms when switch is closed at t_2 .

sweep results, the peak switch voltage is finite, and the average supply current is zero. The deflection system is then lossless and efficient and, because the average yoke current is zero, beam decentering is avoided. The only fault of the circuit of Fig. 86 is the critical timing of the switch, particularly at time $t = t_2$. However, if the switch is shunted by a damper diode, as shown in Fig. 88, the diode acts as a closed switch as soon as the capacitor voltage reverses slightly. The switch may then be closed at any time between t_2 and t_3 .

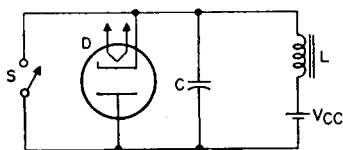

Fig. 88—Incorporation of damper diode.

Fig. 89 shows a typical horizontal-output-and-deflection circuit used in television receivers. In addition to supplying the deflection energy required for horizontal deflection of the picture-tube beam, this circuit provides the high dc voltage required for the ultor (anode) of the picture tube and the "boosted" B voltage for other portions of the receiver. The horizontal-output tube is usually a beam power tube such as the 6JB6A, 6JG6A, or 6LQ6/6JE6C.

In this circuit, a sawtooth voltage from the horizontal-oscillator tube is applied to the grid No. 1 of the horizontal-output tube. When this voltage rises above the cutoff point of the output tube, the tube conducts a sawtooth of plate current which is fed through the auto-transformer to the horizontal-deflecting yoke. At the end of the horizontal-deflecting cycle, which lasts for 63.4 microseconds, the sawtooth voltage on the grid suddenly cuts off the output tube. This sudden change sets up an oscillation of about 50 to 70 kHz in the output circuit, which may be considered as an inductor shunted by the stray capacitance of the circuit. During the first half of this oscillation, a positive voltage appears across the transformer. In the

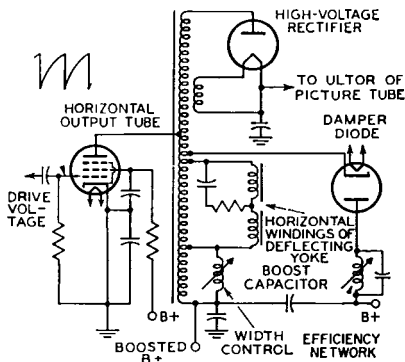

Fig. 89—Typical horizontal-deflection and high-voltage circuit.

second half of the cycle, the voltage swings below the plate supply voltage, and the damper diode conducts, damping out the oscillation. At the same time, the current through the deflecting yoke reverses and reaches its negative peak. As the damper-diode current decays to zero, the output tube begins to conduct again. The yoke current, therefore, is composed of current resulting from damper-diode conduction followed by output-tube conduction.

When the output tube is suddenly cut off, the high-voltage pulse produced is increased by means of an extra winding on the transformer. This high-voltage pulse charges a high-voltage capacitor through the high-voltage rec-

tifier. The output of this circuit is the dc high-voltage supply for the picture tube. The high-voltage rectifier also obtains its filament power through a separate winding on the horizontal-output transformer.

Current flowing through the damper diode charges the "boost" capacitor through the damper portion of the transformer winding. The polarity of the charge on the capacitor is such that the voltage at the low end of the winding is increased above the plate supply voltage, or $B+$. This higher voltage or "boost" is used for the output-tube plate supply, and may also supply the deflection oscillators and other low-current-drain circuits in the receiver.

Vertical Deflection

The vertical-deflection circuit in a television receiver is essentially a class A audio amplifier with a complex load line, severe low-frequency requirements (much lower than 60 Hz), and a need for controlled linearity. The equivalent low-frequency response for a 10-percent deviation from linearity is 1 Hz.

The required performance can be obtained in a vertical-deflection circuit in any of three ways. The amplifier may be designed to provide a flat response down to 1 Hz. This design, however, requires an extremely large output transformer and immense capacitors. Another arrangement is to design the amplifier for fairly good low-frequency response and predistort the generated signal.

The third method is to provide extra gain so that feedback techniques can be used to provide linearity. If loop feedback of 20 or 30 dB is used, tube gain variations and nonlinearities become fairly insignificant. The feedback automatically provides the necessary "predistortion" to correct low-frequency limitations. In addition, the coupling of miscellaneous signals (such as power-supply hum or horizontal-deflection signals) in the amplifying loop is suppressed.

A modified multivibrator in which the vertical-output tube is part of the oscillator circuit is used in the vertical-deflection stage of many television receivers. This stage supplies the deflection energy required for vertical deflection of the picture-tube beam. A simplified combined vertical-oscillator-output stage is shown in Fig. 90. Wave-shapes at critical points of the circuit are included to illustrate the development of the desired current through the vertical-output transformer and deflecting yoke.

The current waveform through the deflecting yoke and output transformer should be a sawtooth to provide the desired deflection. The grid and plate voltage waveforms of the output tube could also be sawtooth except for the effect of the inductive components in the yoke and transformer. The effect of these inductive components must be taken into consideration, however, particularly during retrace. The fast rate of current change during retrace time (which is approximately 1/15 as long as trace

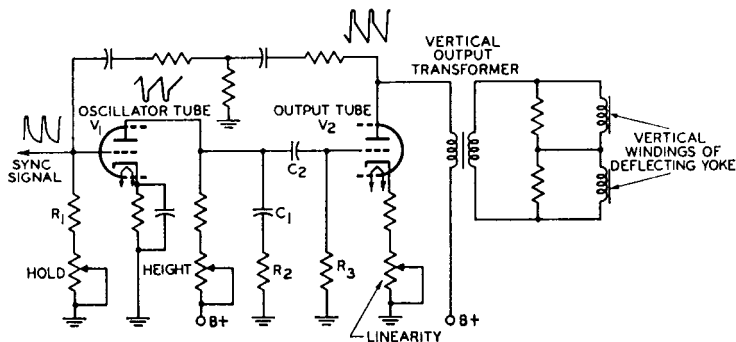

Fig. 90—Simplified combined vertical-oscillator-and-output stage.

time) causes a high-voltage pulse at the plate which could give a trapezoidal waveshape to the plate voltage and cause increased plate current, excess damping, and lengthened retrace time. However, the grid voltage is made sufficiently negative during retrace to keep the tube close to cutoff, as described below.

The frequency, and the relative deviation of the positive and negative portions of each cycle, are dependent on the values of resistors R_1 and R_2 and the RC combination R_3C_2 , as explained in the section on multivibrators. The desired trapezoidal waveshape at the grid of V_2 is created by capacitor C_1 and resistor R_2 . If R_2 were equal to zero, C_1 would cause the grid-voltage waveshape to take the form shown in Fig. 91(a). When R_2 is sufficiently large, C_1 does not discharge completely when V_1 conducts. When V_1 is cut off, therefore, the voltage on the grid of V_2 immediately rises to the voltage across C_1 . The resulting waveshape is shown in Fig. 91(b). The negative-going pulse of the grid-voltage waveshape prevents the high plate pulse from causing excess conduction, and thereby prevents overdamping.



Fig. 91—Waveforms showing effect of R_2 in Fig. 90.

This vertical-deflection stage utilizes twin-triode tubes such as the 6DR7 and 6GF7A. The 6GF7A is particularly suitable for this application because it incorporates dissimilar units to provide for the different operating requirements of the oscillator and output sections.

High-Voltage Regulation

In color television receivers, it is very important to regulate the high-voltage supply for the picture tube. Poor regulation of the high voltage can adversely affect the performance of the focusing and convergence circuits so that picture blooming results. In addi-

tion, excessive voltage or current may be applied to the high-voltage rectifier, horizontal-output tube, and horizontal-output (flyback) transformer so that the useful life of these components is substantially shortened. In modern color television receivers, regulation of the high voltage is accomplished by use of a shunt-type electronic voltage regulator connected across the output of the high-voltage power supply or by use of a pulse-type regulator connected in shunt with the flyback transformer.

Shunt Regulator Circuit—Fig. 92 shows the schematic diagram of a typical shunt regulator circuit. This circuit uses a 6BK4C/6EL4 or 6EN4 sharp-cutoff beam triode for the regulator tube and is suitable for regulation of the output of a high-voltage, high-impedance supply. The cathode of the regulator beam triode is held at a fixed positive potential with respect to ground. Because the grid potential is kept slightly less positive by the voltage drop across resistor R_2 , the tube operates in the negative grid region and no grid current is drawn.

When the output voltage, e_o , rises as a result of a decrease in load current,

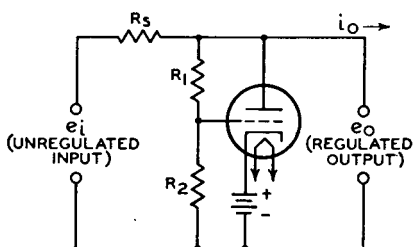

Fig. 92—High-voltage regulator circuit for color television.

a small fraction of the additional voltage is applied to the grid of the tube by the voltage-divider circuit consisting of R_1 and R_2 . This increased grid voltage causes the tube to draw an increased current from the unregulated supply. The increased current, in turn, causes a voltage drop across the high internal impedance of the unregulated supply, R_s , which tends to counteract the original rise of the voltage. If desired, the

grid may be connected to a variable point on the voltage divider to allow some adjustment of the output-voltage level.

The grid voltage for the regulator can also be obtained from a tap on the B-boost voltage supply. The use of this lower voltage (about 375 volts) eliminates the need for costly and troublesome high-voltage resistors. In this arrangement, variations in high voltage also vary the tapped-down B-boost voltage at the regulator grid, and the resulting variations in conduction of the regulator increase or decrease the loading of the high-voltage supply so that the total load remains nearly constant.

The shunt regulator circuit, in effect, presents a variable load impedance to the output of the high-voltage rectifier. Because the regulator is connected directly across the output of the rectifier, the regulator tube is required to handle the full amount of the high voltage (approximately 25 kilovolts) applied to the picture tube. The tube area, therefore, must be well shielded to provide adequate X-ray protection, and a relatively large area is required for voltage insulation. In addition, the high-voltage rectifier is required to conduct full-load current continuously. The shunt regulator maintains a constant high voltage by sensing changes in the B Boost voltage, which are indicative of changes in beam current, and increasing or decreasing conduction accordingly.

Pulse Regulator Circuit—In a pulse-regulator system, the regulator circuit is effectively shunted across part of the horizontal winding of the horizontal-output transformer. During operation, the pulse-regulator circuit maintains a substantially constant pulse amplitude in the primary winding of the horizontal-output transformer with changing loads on the high-voltage power supply. A constant-amplitude, stepped-up pulse is then applied to the high-voltage rectifier tube, and the high voltage developed from this pulse is maintained at a constant value. In the pulse-regulator system, regulator control is achieved by sampling the picture-

tube current by means of a special winding on the fly-back transformer and use of the resultant voltage drop (across a resistor) to control the grid circuit of the regulator tube.

Fig. 93 shows the schematic diagram and significant waveforms for a circuit that uses a 17KV6A beam-power pentode for the regulator tube. During trace and retrace, the cathode of the 17KV6A is held at B+. During the trace period, the screen grid of the 17KV6A is biased well below the cathode voltage and is unaffected by the beam current drawn by the picture tube. The control-grid bias is determined by the resistive voltage-divider network R_2 , R_3 , R_1 , and R_5 and is directly dependent on the beam current of the picture tube. The damper tube conducts during the trace period and holds the plate potential of the 17KV6A at B+. With the plate-to-cathode potential at zero and the screen grid negative with respect to the cathode, the regulator tube is completely cut off during the trace period. At the start of the retrace period, however, the damper tube becomes reverse-biased, and the voltage on the plate of the regulator tube begins to rise. This increasing voltage is coupled to the screen grid through C_1 and R_1 and to the control grid through the interelectrode capacitance of the tube.

The waveforms in Fig. 93 show that at the start of retrace the plate and screen grid of the 17KV6A have both been driven positive with respect to the cathode and the control grid has become less negative with respect to the cathode. The regulator tube then begins to conduct. The pulses impressed on the screen and control grids are short in duration so that the screen grid remains positive with respect to the cathode and the control grid remains near cathode potential for only a short time. The regulator tube is driven into conduction for approximately 2 to 4 microseconds at the start of retrace and is then cut off. As the beam current increases or decreases, the voltage developed across the re-

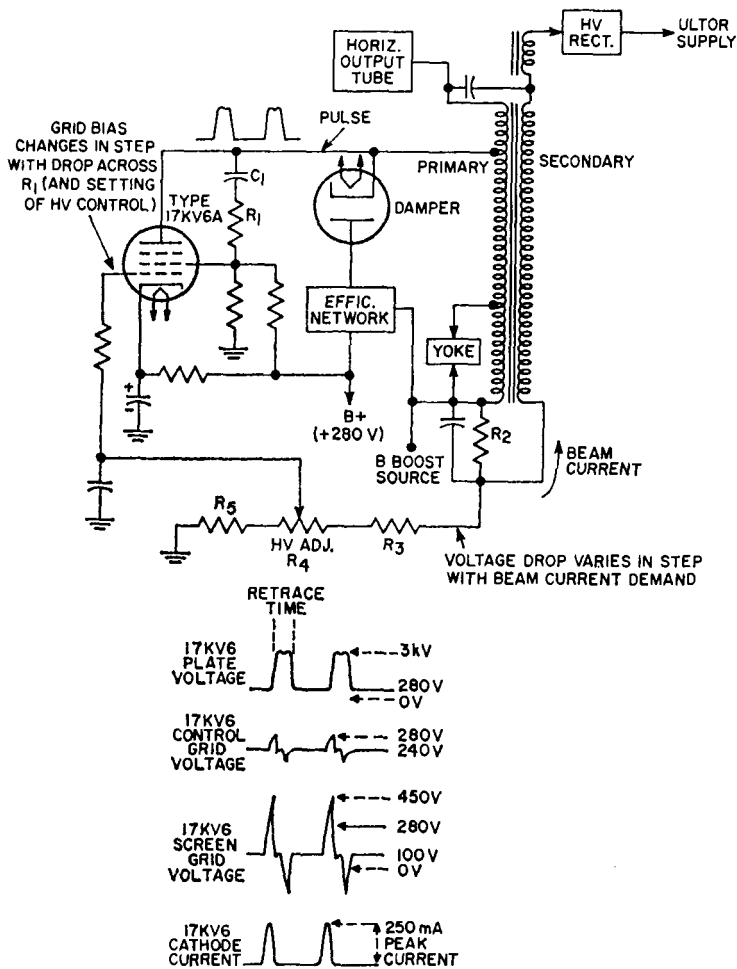

Fig. 93—Schematic diagram and significant waveforms for a typical pulse-regulator circuit.

sistive voltage-divider network R_2 , R_3 , R_4 , and R_5 tracks these changes and is applied to the control grid of the regulator tube. In this way, the conduction of the regulator tube is increased or decreased as required to maintain a constant high-voltage output. By re-

moval of the energy from the rising edge of the flyback pulse in this fashion, the height of the pulse used to develop the high voltage is controlled. At the same time interference with the shape of the deflection pulse is held to a minimum.

Color Demodulation

In the transmission of picture signals for color-television receivers, all the color information is contained in three signals, a luminance (black-and-white) or monochrome signal and two chrominance signals. The luminance signal, which is called the Y signal, contains brightness information only. The voltage response of the Y signal is made similar to the brightness response of the human eye by use of a composite signal that contains definite proportions of the red, green, and blue signals from the color-television camera (30 per cent red, 59 per cent green, and 11 per cent blue). This Y signal, which includes sync and blanking pulses, provides a correct monochrome picture in a conventional black-and-white television receiver.

For the generation of color-television signals, the Y signal is subtracted from the red, green, and blue signals to provide a new set of color-difference signals, which are designated as R-Y, B-Y, and G-Y. All of the original picture information is contained in the Y signal, the R-Y signal, and the B-Y signal. Therefore, the G-Y signal is not contained in the transmitted signal, but is synthesized in the receiver by proper combination of the R-Y and B-Y signals.

(Color signals transmitted under present color-television standards are not R-Y and B-Y, but a similar pair of signals designated as I and Q. In the color-television receiver, R-Y and B-Y signals are demodulated directly from the I and Q signals with negligible loss

of color quality. For purposes of simplicity, only R-Y and B-Y signals are considered in this explanation. In addition, a 90-degree phase-shift network is shown; the phase-shift angle could be, and often is, some other value.)

Because the luminance signal and the two color-difference signals must be transmitted with a standard 6-MHz channel, the two color signals are combined into one signal at the transmitter and are independently recovered at the receiver by proper detection techniques. A color subcarrier of approximately 3.58 MHz is used for transmitting the color information within the 6-MHz spectrum of the television station. As shown in Fig. 94, the 3.58-MHz subcarrier and one of the color-difference signals are applied directly to a balanced AM modulator. The other color-difference signal is applied directly to a second balanced AM modulator, and the 3.58-MHz subcarrier is applied to this second modulator through a 90-degree phase-shifting network. The balanced modulators effectively cancel both the individual color-difference signals and the subcarrier signal, and the output contains only the sidebands of the combined chrominance signal.

Recovery of the color information at the receiver involves a process called **synchronous detection**. In this process, two separate detectors are used to recover the separate color information, just as two separate modulators were used to combine the information at the transmitter. The 3.58-MHz subcarrier, which was suppressed during transmission, must be reinserted at the receiver for recovery of the color information.

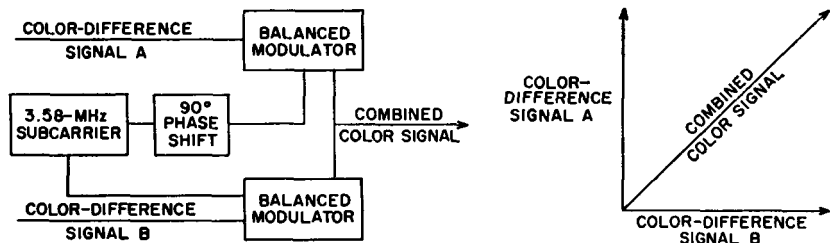

Fig. 94—Formation of combined color signal for transmission.

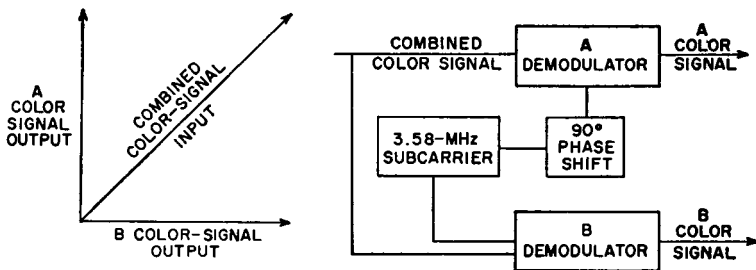

Fig. 95—Separation of combined color signal into two signals at the receiver.

The basis of synchronous detection is the phase relationship of this reinserted 3.58-MHz subcarrier.

For example, the original color information is represented in Fig. 94 by the color-difference signals A and B. At the receiver, the combined color signal is fed to two demodulators A and B, as shown in Fig. 95. At the same time, a 3.58-MHz subcarrier is also fed to the two demodulators, with the same phase relationship that was used in the modulators at the transmitter. This locally generated subcarrier essentially duplicates or replaces the original subcarrier, which was removed at the transmitter.

The local 3.58-MHz oscillator in the color-television receiver is made to function at the proper frequency and phase by means of a synchronizing signal sent out by the transmitter. This synchronizing signal consists of a short burst of 3.58-MHz signals transmitted during the horizontal blanking interval, immediately after the horizontal sync pulse, as shown in Fig. 96.

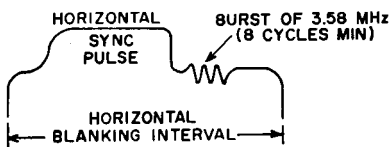

Fig. 96—Waveform for synchronizing signal.

Fig. 97 shows a simplified diagram of a low-level color demodulator fre-

quently used in color-television receivers. The locally generated 3.58-MHz signal is applied to the grid No. 3 of the pentode. The transmitted color signal containing the 3.58-MHz sidebands is applied to grid No. 1. The phase of the 3.58-MHz color signal constantly changes in accordance with its color content. For example, the following table shows six variations in color (hue) as a function of subcarrier phase:

Subcarrier Phase—degrees (with respect to 3.58-MHz local signal in phase with burst)	Hue
13	Yellow
77	Red
119	Magenta
193	Blue
257	Cyan
299	Green

The basic operating principle of the color demodulator shown in Fig. 97 is that plate current from the pentode is zero (or quite low) unless both grid No. 1 and grid No. 3 are simultaneously positive. For example, when the signals applied to the two grids are in phase, plate current can be expected to flow for 180 degrees of each ac cycle. Conversely, when the signals are 180 degrees out of phase, plate current is cut off. The output signal from the detector, therefore, is a function of the phase relationship between the transmitted color signal and the locally generated subcarrier.

In a typical color-television receiver, two color demodulators of the

type shown in Fig. 97 are required. In one demodulator, the 3.58-MHz subcarrier signal is applied directly to the pentode grid No. 3 from the local "burst" oscillator. In the other demodulator, the 3.58-MHz signal from the

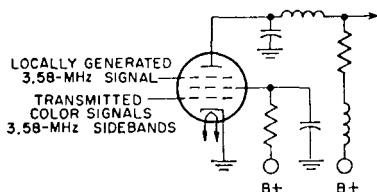

Fig. 97—Low-level color demodulator.

burst oscillator is shifted 90 degrees in phase before it is applied to the pentode grid No. 3. As shown previously in Fig. 95, the demodulator B produces R-Y signals. These B-Y and R-Y signals are then combined (matrixed) to produce the G-Y signal, as discussed earlier. The complete luminance signal is then amplified to the required level in a conventional video-amplifier circuit.

In some color-television receivers, the demodulators are designed so that the color output signals can be applied directly to the color picture tube. In the diagram shown in Fig. 98, for example, the 6JH8 sheet-beam demodula-

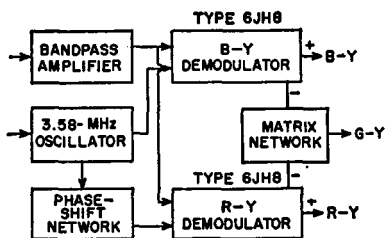

Fig. 98—Block diagram of demodulator circuit used to apply signals directly to color picture tube.

tors produce both positive and negative B-Y and R-Y signals. The positive signals are applied directly to the control grids (grid No. 1) of the blue and red guns of the color picture tube. At the same time, the negative color-difference signals are added (matrixed) in the correct proportions to produce the G-Y

signal, which is applied to grid No. 1 of the green gun.

Oscillation

As an oscillator, an electron tube can be employed to generate a continuously alternating voltage. In present-day radio broadcast receivers, this application is limited practically to superheterodyne receivers for supplying the heterodyning frequency. Several circuits (represented in Fig. 99) may be utilized, but they all depend on feeding more energy from the plate circuit to the grid circuit than is required to equal the power loss in the grid circuit. Feedback may be produced by electrostatic or electromagnetic coupling between the grid and plate circuits. When sufficient energy is fed back to more than compensate for the loss in the grid circuit, the tube will oscillate.

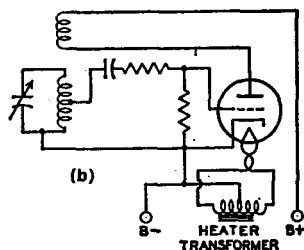
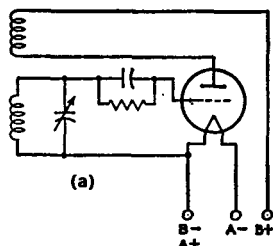

Fig. 99—Tuned-grid triode oscillator circuit: (a) using filament-type tube; (b) using heater-cathode-type tube.

The action consists of regular surges of power between the plate and the grid circuit at a frequency dependent on the circuit constants of inductance and capacitance. By proper choice of these values, the frequency may be adjusted over a very wide range.

Multivibrators

Relaxation oscillators, which are widely used in present-day electronic equipment, are used to produce non-sinusoidal waveshapes such as rectangular and sawtooth pulses. Probably the most common relaxation oscillator is the multivibrator, which may be considered as a two-stage resistance-coupled amplifier in which the output of each tube is coupled into the input of the other tube.

Fig. 100 is a basic multivibrator circuit of the free-running type. In this circuit, oscillations are maintained by the alternate shifting of conduction from one tube to the other. The cycle usually starts with one tube, V_1 , at zero bias, and the other, V_2 , at cutoff or beyond. At this point, the capacitor C_1 is charged sufficiently to cut off V_2 . C_1 then begins to discharge through the resistor R_4 , and the voltage on the grid of V_2 rises until V_2 begins to conduct. The voltage on the plate of V_2 then decreases, causing V_1 to conduct less and less. At the same time, the plate voltage of V_1 begins to rise, causing V_2 to conduct still more heavily. Because of the amplification, this cumulative effect builds up extremely fast, and conduction switches from V_1 to V_2

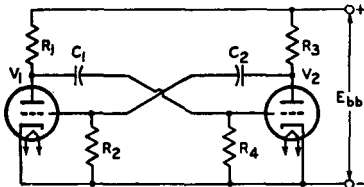

Fig. 100—Basic multivibrator circuit of the free-running type.

within a few microseconds, depending on the circuit components.

In this circuit, therefore, conduction switches from V_1 to V_2 over the interval during which C_1 discharges from the voltage across R_4 to the cutoff voltage for V_2 . The actual transfer of conduction does not occur until cutoff is reached. Conduction switches back to V_1 through a similar process to complete the cycle. The plate waveform is essentially rectangular in shape, and

may be adjusted as to symmetry, frequency, and amplitude by proper choice of circuit constants, tubes, and voltages.

Although this type of multivibrator is free-running, it may be triggered by pulses of a given amplitude and frequency to provide a frequency-stabilized output. Multivibrator circuits may also be designed so that they are not free-running, but must be triggered externally to shift conduction from one tube to the other. Depending on the type of circuit, conduction may shift back to the first tube after a given time interval, or the second tube may continue conducting until another trigger signal is applied.

Synchroguide Circuits

The "synchroguide" is a controlled type of oscillator used in television receivers to generate and control the synchronized sawtooth voltage necessary for adequate line- or horizontal-frequency scanning. A simplified synchroguide circuit is shown in Fig. 101. This circuit provides stable, noise-free control of a blocking oscillator which generates a horizontal-frequency signal. It permits comparison of the received sync pulses and the generated sawtooth voltages so that properly locked-in horizontal scanning results.

The triode V_2 in Fig. 101 is a conventional blocking oscillator which enables a sawtooth voltage to be developed across the capacitor C_2 . A portion of this sawtooth is fed back to the grid of

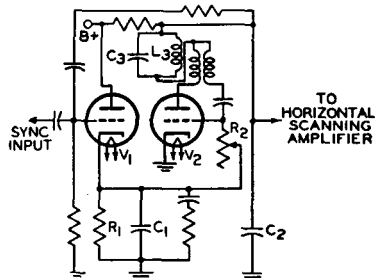

Fig. 101—Simplified synchroguide circuit.

the control tube, V_1 . The positive sync pulses are also applied to the grid of

V_1 . The waveforms shown in Fig. 102 illustrate the sawtooth and sync pulses (A and B) and their proper "in-sync" combination (C). The sync pulse occurs partly during the portion of the sawtooth voltage in which the triode V_1 draws current. Any shift in sync pulse as it is superimposed on the sawtooth, therefore, will affect the amount of conduction of the control tube. A change in control-tube conduction ultimately affects the bias on the oscillator-tube grid by changing the voltage to which the capacitor C_1 in the cathode circuit may charge. An increase in the positive bias increases the frequency of oscillation.

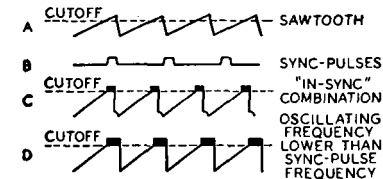

Fig. 102—Sawtooth and sync pulses in synchroguide circuit.

For example, waveform D in Fig. 102 illustrates a condition in which the sawtooth voltage is advanced in phase with respect to the sync pulses. The widening of the pulse which occurs at the corner of the sawtooth waveform allows the control tube to conduct more current and, consequently, allows the capacitor C_1 to charge to a higher voltage. This increased reference voltage also appears in the grid circuit of V_2 and makes the grid more positive. The increased grid voltage then speeds up the frequency of oscillations until proper synchronization results.

The blocking oscillator can be made more immune to changes in frequency and noise if V_2 is brought out of cutoff very sharply. This effect is obtained by sine-wave stabilization. The tuned circuit L_3C_3 in the plate circuit of Fig. 101 superimposes a shock-excited sine wave on the plate and grid waveforms, as shown in Fig. 103.

The blocking oscillator can be made more immune to changes in frequency and noise if V_2 is brought out of cutoff very sharply. This effect is obtained by sine-wave stabilization. The tuned circuit L_3C_3 in the plate circuit of Fig. 101 superimposes a shock-excited sine wave on the plate and grid waveforms, as shown in Fig. 103.

Automatic Frequency Control

An automatic frequency control

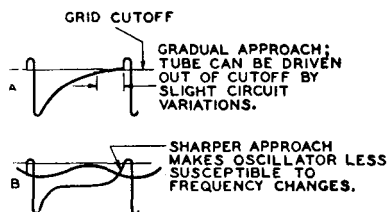

Fig. 103—Waveforms showing effect of tuned circuit L_3C_3 in Fig. 101.

(afc) circuit provides a means of correcting automatically the intermediate frequency of a superheterodyne receiver when, for any reason, it drifts from the frequency to which the if stages are tuned. This correction is made by adjusting the frequency of the oscillator. Such a circuit will automatically compensate for slight changes in rf carrier or oscillator frequency as well as for inaccurate manual or push-button tuning.

An afc system requires two sections: a frequency detector and a variable reactance. The detector section may be essentially the same as the FM detector illustrated in Fig. 30 and discussed under **Detection**. In the afc system, however, the output is a dc control voltage, the magnitude of which is proportional to the amount of frequency shift. This dc control voltage is used to control the grid bias of an electron tube which comprises the variable reactance section (Fig. 104).

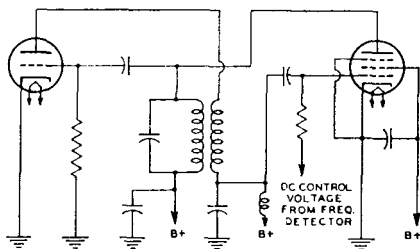

Fig. 104—Automatic-frequency-control (afc) circuit.

The plate current of the reactance tube is shunted across the oscillator tank circuit. Because the plate current and plate voltage of the reactance tube are

almost 90 degrees out of phase, the control tube affects the tank circuit in the same manner as a reactance. The grid bias of the tube determines the magnitude of the effective reactance and, consequently, a control of this grid bias can be used to control the oscillator frequency.

Automatic frequency control is also used in television receivers to keep the horizontal oscillator in step with the horizontal-scanning frequency (15,750 Hz) at the transmitter. A widely used horizontal afc circuit is shown in Fig. 105. This circuit, which is often referred to as a **balanced-phase-detector** or **phase-discriminator** circuit, is usually employed to control the frequency of a multivibrator-type horizontal-oscillator circuit. The 6AL5 detector supplies a dc control voltage to the grid of the horizontal-oscillator tube which counteracts changes in its operating frequency. The magnitude and polarity of the control voltages are determined by phase relationships in the afc circuit at a given moment.

The horizontal sync pulses obtained from the sync-separator circuit are fed through a single-triode phase-inverter or phase-splitter circuit to the two diode units of the 6AL5. Because of the action of the phase-inverter circuit, the signals applied to the two diode units are equal in amplitude but 180 degrees out of

phase. A reference sawtooth voltage obtained from the horizontal output circuit is also applied simultaneously to both units. Any change in the oscillator frequency alters the phase relationship between the reference sawtooth and the incoming horizontal sync pulses, causing one diode unit of the 6AL5 to conduct more heavily than the other, and thus producing a correction signal. The system remains balanced at all times, therefore, because momentary changes in oscillator frequency are instantaneously corrected by the action of the control voltage.

The diode units of the 6AL5 are biased so that conduction takes place only during the tips of the sync pulses. The relative position of the sync pulses on the retrace portion of the sawtooth waveform at any given instant determines which diode unit conducts more heavily, and thereby establishes the magnitude and polarity of the control voltage. The network between the diode units and the grid of the horizontal-oscillator tube is essentially a low-pass filter which prevents the horizontal sync pulses from affecting the horizontal-oscillator performance.

Frequency Conversion

Frequency conversion is used in superheterodyne receivers to change the frequency of the rf signal to an intermediate frequency. To perform this change in frequency, a frequency-converting device consisting of an oscillator and a frequency mixer is employed. In such a device, shown diagrammatically in Fig. 106, two voltages of different frequency, the rf signal voltage and the voltage generated by the oscillator, are applied to the input of the frequency mixer. These voltages beat, or heterodyne, within the mixer tube to produce a plate current having, in addition to

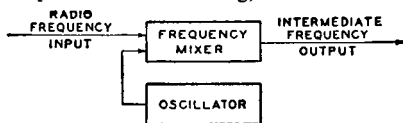

Fig. 106—Block diagram of simple frequency-converter circuit.

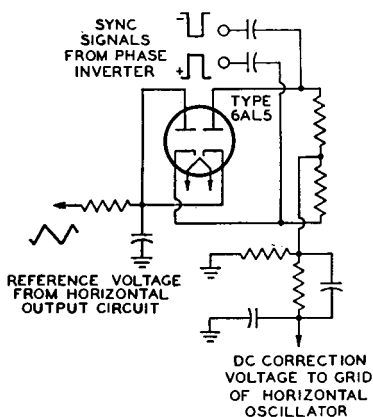

Fig. 105—Balanced phase-detector or phase-discriminator circuit for horizontal afc.

the frequencies of the input voltages, numerous sum and difference frequencies.

The output circuit of the mixer stage is provided with a tuned circuit which is adjusted to select only one beat frequency, *i.e.*, the frequency equal to the difference between the signal frequency and the oscillator frequency. The selected output frequency is known as the intermediate frequency, or *if*. The output frequency of the mixer tube is kept constant for all values of signal frequency by tuning the oscillator to the proper frequency.

Important advantages gained in a receiver by the conversion of signal frequency to a fixed intermediate frequency are high selectivity with few tuning stages and a high, as well as stable, overall gain for the receiver.

Several methods of frequency conversion for superheterodyne receivers are of interest. These methods are alike in that they employ a frequency-mixer tube in which plate current is varied at a combination frequency of the signal frequency and the oscillator frequency. These variations in plate current produce across the tuned plate load a voltage of the desired intermediate frequency. The methods differ in the types of tubes employed and in the means of supply input voltages to the mixer tube.

A method widely used before the availability of tubes especially designed for frequency-conversion service, and currently used in many FM, television, and standard broadcast receivers, employs as mixer tube either a triode, a tetrode, or a pentode, in which oscillator voltage and signal voltage are applied to the same grid. In this method, coupling between the oscillator and mixer circuits is obtained by means of inductance or capacitance.

A second method employs a tube having an oscillator and frequency mixer combined in the same envelope. In one form of such a tube, coupling between the two units is obtained by means of the electron stream within the tube. Because five grids are used, the tube is called a pentagrid converter.

Grids No. 1 and No. 2 and the

cathode are connected to an external circuit to act as a triode oscillator. Grid No. 1 is the grid of the oscillator and grid No. 2 is the anode. Grid No. 2 is connected within the tube to the screen grid (grid No. 4). The combined two grids, Nos. 2 and 4, shield the signal grid (grid No. 3) and act as the composite anode of the oscillator triode. Grid No. 5 acts as the suppressor grid.

Converter tubes of this type are designed so that the space charge around the cathode is unaffected by electrons from the signal grid. Furthermore, the electrostatic field of the signal grid also has little effect on the space charge. The result is that rf voltage on the signal grid produces little effect on the cathode current. There is, therefore, little detuning of the oscillator by *avc* bias because changes in *avc* bias produce little change in oscillator transconductance or in the input capacitance of grid No. 1.

Examples of the pentagrid converters discussed in the preceding paragraph are the single-ended types 1R5 and 6BE6. A schematic diagram illustrating the use of the 6BE6 with self-excitation is given in Fig. 107. The 6BE6 may also be used with separate excitation. A complete circuit is shown in the **Circuits** section.

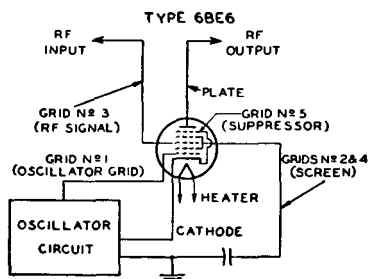

Fig. 107—Frequency-converter circuit using the 6BE6 pentagrid converter with self-excitation.

A further method of frequency conversion employs a tube called a pentagrid mixer. This type has two independent control grids and is used with a separate oscillator tube. RF signal voltage is applied to one of the control grids

and oscillator voltage is applied to the other. It follows, therefore, that the variations in plate current are due to the combination of the oscillator and signal frequencies.

The tube contains a heater-cathode, five grids, and a plate. Grids Nos. 1 and 3 are control grids. The rf signal voltage is applied to grid No. 1. This grid has a remote-cutoff characteristic and is suited for control by avc bias voltage. The oscillator voltage is applied to grid No. 3. This grid has a sharp-cutoff characteristic and produces a comparatively large effect on plate current for a small amount of oscillator voltage. Grids Nos. 2 and 4 are connected together within the tube. They accelerate the electron stream and shield grid No. 3 electrostatically from the other electrodes. Grid No. 5, connected within the tube to the cathode, functions similarly to the suppressor grid in a pentode.

In the converter or mixer stage of a television receiver, stable oscillator operation is most readily obtained when separate tubes or tube sections are used for the oscillator and mixer functions. A typical television mixer-oscillator circuit is shown in Fig. 108. In such circuits, the oscillator voltage is applied to the mixer grid by inductive coupling, capacitive coupling, or a combination of the two. Tubes containing electrically independent oscillator and mixer units in the same envelope, such as the 6EA8 and 6KE8 are designed especially for this application.

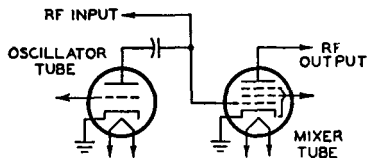

Fig. 108—Typical television mixer-oscillator circuit.

Tuning Indication With Electron-Ray Tubes

Electron-ray tubes are designed to indicate visually by means of a fluorescent target the effects of a change in controlling voltage. One application of them is as tuning indicators in radio receivers. Types such as the 6U5 and

the 6E5 contain two main parts: (1) a triode which operates as a dc amplifier and (2) an electron-ray indicator which is located in the bulb as shown in Fig. 109. The target is operated at a positive voltage and, therefore, attracts electrons from the cathode. When the electrons strike the target they produce a glow on the fluorescent coating of the target. Under these conditions, the target appears as a ring of light.

A ray-control electrode is mounted between the cathode and target. When the potential of this electrode is less positive than the target, electrons flowing to the target are repelled by the electrostatic field of the electrode, and do not reach that portion of the target behind the electrode. Because the target does not glow where it is shielded from electrons, the control electrode casts a

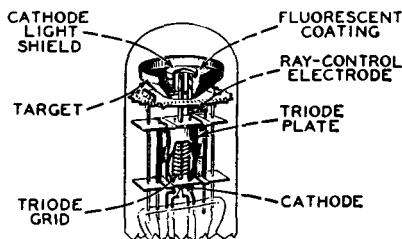

Fig. 109—Structure of electron-ray tube.

shadow on the glowing target. The extent of this shadow varies from approximately 100 degrees of the target when the control electrode is much more negative than the target to 0 degrees when the control electrode is at approximately the same potential as the target.

In the application of the electron-ray tube, the potential of the control electrode is determined by the voltage on the grid of the triode section, as can be seen in Fig. 110. The flow of the triode plate current through resistor R produces a voltage drop which determines the potential of the control electrode. When the voltage of the triode grid changes in the positive direction, plate current increases, the potential of the control electrode goes down because of the increased drop across R, and the

shadow angle widens. When the potential of the triode grid changes in the negative direction, the shadow angle narrows.

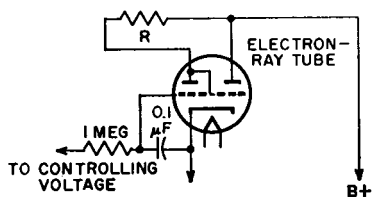
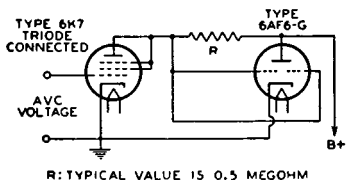

Fig. 110—Indicating circuit using an electron-ray tube.

Another type of indicator tube is the 6AF6G. This tube contains only an indicator unit but employs two ray-control electrodes mounted on opposite sides of the cathode and connected to individual base pins. It employs an external dc amplifier. (See Fig. 111.) Thus, two symmetrically opposite shadow angles may be obtained by connecting the two ray-control electrodes together; or, two unlike patterns may be obtained by individual connection of each ray-control electrode to its respective amplifier.

In radio receivers, avc voltage is applied to the grid of the dc amplifier.



R: TYPICAL VALUE IS 0.5 MEGOHM

Fig. 111—Indicating circuit using 6AF6G electron-ray tube and external dc amplifier.

Because avc voltage is at maximum when the set is tuned to give maximum response to a station, the shadow angle is at minimum when the receiver is tuned to resonance with the desired station.

The choice between electron-ray tubes depends on the avc characteristic of the receiver. The 6E5 contains a sharp-cutoff triode which closes the shadow angle on a comparatively low value of avc voltage. The 6U5 has a remote-cutoff triode which closes the shadow on a larger value of avc voltage than the 6E5. The 6AF6G may be used in conjunction with dc amplifier tubes having either remote- or sharp-cutoff characteristics.

Electron Tube Installation

THE installation of electron tubes requires care if reliable performance is to be obtained from the associated circuits. Installation suggestions and precautions which are generally common to all types of tubes are covered in this section. Additional pertinent information is given under each tube type and in the **Circuits** section.

Filament and Heater Power Supply

The design of electron tubes allows for some variation in the voltage and current supplied to the filament or heater, but most satisfactory results are obtained from operation at the rated values. When the voltage is low, the temperature of the cathode is below normal, with the result that electron emission is limited. The limited emission may cause unsatisfactory operation and reduced tube life. On the other hand, high heater voltage may cause rapid evaporation of cathode material and shorten tube life.

To insure proper tube operation, it is important that the filament or heater voltage be checked at the socket terminals by means of a high-resistance voltmeter while the equipment is in operation. In the case of series operation of heaters or filaments, correct adjustment can be checked by means of an ammeter in the heater or filament circuit.

The filament or heater voltage supply may be a direct-current source (a battery or a dc power line) or an alternating-current power line, depending on the type of service and type of tube.

Ordinarily, a step-down transformer is used with an ac supply to provide the proper filament or heater voltage. Receivers intended for operation on both dc and ac power lines have the heaters connected in series with a suitable resistor and supplied directly from the power line.

Mobile and marine receivers have the heaters of the tubes connected directly across the battery supply.

Parallel heater operation usually requires a step-down transformer to reduce the 120 Vac line voltage to typically 6.3 Vac. Care must be taken to prevent excessive voltage drop in the heater circuit wiring which would result in incorrect voltage at the tube terminals.

Series heater operation eliminates the need for a step-down transformer and is economical when a number of tubes rated at the same heater current have a total heater voltage drop which adds up to an available supply voltage. A voltage-dropping resistor in series with the heaters and the supply line is usually required. This resistance should be of such value that for normal line voltage the tubes will operate at their rated heater current. The resistor value is calculated by the following formula.

$$\text{Required resistance (ohms)} = \frac{\text{supply volts} - \text{total rated volts of tubes}}{\text{rated amperes of tubes}}$$

The power dissipation of the resistor (in watts) is equal to the voltage drop of the resistor multiplied by the series string current in amperes. A resistor having a wattage rating well

in excess of this value should be chosen.

A convenient means exists for obtaining a heater supply voltage drop without the disadvantage of a power-dissipating resistor. A diode in series with the 120 Vac line provides a half wave rectified sine wave of 84 V ($\frac{\sqrt{2}}{2} \times \text{RMS input}$). The diode polarity should be such as to operate the heaters negative. (See **heater-cathode voltage** below.) In TV receivers designed for instant-on operation such a series-connected diode can be used for stand-by operation (70% of rated heater voltage) of a 120 Vac series string.

Heater-Cathode Voltage

When the series-heater connection is used in equipment, it is advisable to arrange the heaters in the circuit so that tubes most sensitive to hum disturbances are at or near ground potential of the circuit. This arrangement reduces the amount of AC heater-cathode voltage of these tubes and minimizes hum interference. Other tubes operated with grounded cathode, such as horizontal deflection amplifiers or tube insulated for high heater cathode voltage, such as damper, are more immune to heater-cathode leakage.

Typical orders of series-string connections, by tube function, are shown below.

Heater-type tubes may produce

hum as a result of conduction between heater and cathode or between heater and control grid, or by modulation of the electron stream by the alternating magnetic field surrounding the heater. When a large resistor is used between heater and cathode (as in series-connected heater strings), or when one side of the heater is grounded, even a minute pulsating leakage current between heater and cathode can develop a small voltage across the cathode-circuit impedance and cause objectionable hum. The use of a large cathode bypass capacitor is recommended to minimize this source of hum.

Much lower hum levels can be achieved when heaters are connected in parallel systems in which the center-tap of the heater supply is grounded or, preferably, connected to a positive bias source of 15 to 80 volts dc to reduce the flow of alternating current. The heater leads of the tubes should be twisted and kept away from high-impedance circuits. The balanced ac supply provides almost complete cancellation of the alternating-current components.

The balanced arrangement described above also minimizes heater-grid hum. High grid-circuit impedances should be avoided, if possible. High heater voltages should also be avoided because heater-cathode hum rises sharply when the heater voltage is increased above the published value.

Certain tube types are designed especially to minimize hum in high-quality, high-fidelity audio equipment. Examples are the 5879, 7025, and 7199.

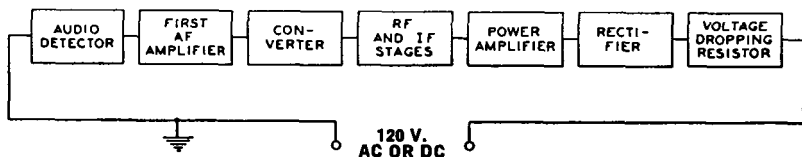

Fig. 112A—Order of series heater-string connection, by tube function, to minimize hum in a radio receiver.

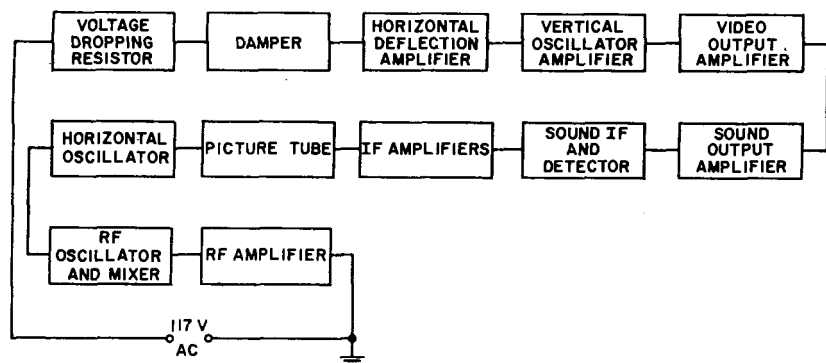

Fig. 112B—Order of series heater-string connection, by tube function, to minimize hum in a TV receiver.

Plate Voltage Supply

The plate voltage for electron tubes is obtained from batteries, rectifiers, direct-current power lines, and small local generators. The maximum plate-voltage value for any tube type should not be exceeded if most satisfactory performance is to be obtained. Plate voltage should not be applied to a tube unless the corresponding recommended voltage is also supplied to the grid.

It is recommended that the primary circuit of the power transformer be fused to protect the rectifier tube(s), the power transformer, filter capacitor, and chokes in case a rectifier tube fails.

Grid Voltage Supply

The recommended grid voltages for different operating conditions have been carefully determined to give the most satisfactory performance. Grid voltage may be obtained from a fixed source such as a separate C-battery or a tap on the voltage divider of the high-voltage dc supply, from the voltage drop across a resistor in the cathode circuit, or from the voltage drop across a resistor in the grid circuit. The first method is called "fixed bias"; the second is called "cathode bias" or "self bias"; the third is called "grid-resistor bias" and is sometimes incorrectly referred to in receiving-tube practice as "zero-bias operation."

In any case, the object is to make the grid negative with respect to the cathode by the specified voltage. When a C-battery is used, the negative terminal is connected to the grid return and the positive terminal is connected to the negative filament socket terminal, or to the cathode terminal if the tube is of the heater-cathode type. If the filament is supplied with alternating current, this connection is usually made to the center-tap of a low resistance (20 to 50 ohms) shunted across the filament terminals. This method reduces hum disturbances caused by the ac supply. If bias voltages are obtained from the voltage divider of a high-voltage dc supply, the grid return is connected to a more negative tap than the cathode.

The **cathode-biasing** method utilizes the voltage drop produced by the cathode current flowing through a resistor connected between the cathode and the negative terminal of the B-supply. (See Fig. 113.) The cathode current is, of course, equal to the plate current in the case of a triode, or to the sum of the plate and grid-No. 2 currents in the case of a tetrode, pentode, or beam power tube. Because the voltage drop along the resistance is increasingly negative with respect to the cathode, the required negative grid-bias voltage can be obtained by connecting the grid return to the negative end of the resistance.

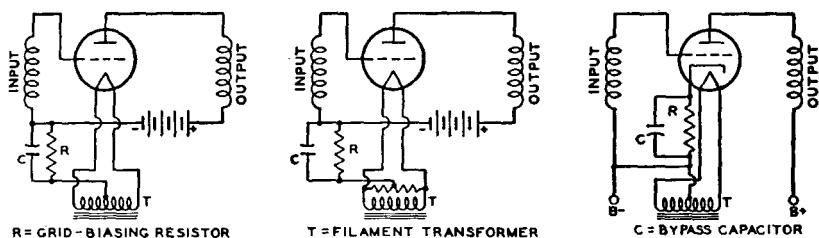

Fig. 113—Typical grid-voltage supply circuits.

The value of the resistance for cathode-biasing a single tube can be determined from the following formula:

$$\text{Resistance (ohms)} = \frac{\text{desired grid-bias voltage} \times 1000}{\text{rated cathode current in milliamperes}}$$

Thus, the resistance required to produce 9 volts bias for a triode which operates at 3 milliamperes plate current is $9 \times 1000/3 = 3000$ ohms. If the cathode current of more than one tube passes through the resistor, or if the tube or tubes employ more than three electrodes, the total current determines the size of the resistor.

Bypassing of the cathode-bias resistor depends on circuit-design requirements. In rf circuits the cathode resistor usually is bypassed. In af circuits the use of an unbypassed resistor will reduce distortion by introducing degeneration into the circuit. However, the use of an unbypassed resistor decreases gain and power sensitivity. When bypassing is used, it is important that the bypass capacitor be sufficiently large to have negligible reactance at the lowest frequency to be amplified.

In the case of power-output tubes having high transconductance, such as beam power tubes, it may be necessary to shunt the bias resistor with a small mica capacitor (approximately 0.001 μ F) in order to prevent oscillations. The usual af bypass may or may not be used, depending on whether or not degeneration is desired. In tubes having high values of transconductance, such as the 6BA6, 6CB6A, and 6AC7, input capacitance and input conductance change appreciably with plate current.

When such a tube having a separate suppressor-grid connection is used as an rf amplifier, these changes may be minimized by leaving a certain portion of the cathode-bias resistor unbypassed. In order to minimize feedback when this method is used, the external grid-No. 1-to-plate (wiring) capacitances should be kept to a minimum, the grid No. 2 should be bypassed to ac ground, and the grid No. 3 should be connected to ac ground.

The use of a cathode resistor to obtain bias voltage is not recommended for amplifiers in which there is appreciable shift of electrode currents with the application of a signal. In such amplifiers, a separate fixed supply is recommended.

The **grid-resistor biasing** method is also a self-bias method because it utilizes the voltage drop across the grid resistor produced by small amounts of grid current flowing in the grid-cathode circuit. This current is due to (1) an electromotive potential difference between the materials comprising the grid and cathode and (2) grid rectification when the grid is driven positive. A large value of resistance is required in order to limit this current to a very small value and to avoid undesirable loading effects on the preceding stage.

Examples of this method of bias are given in the **Circuits** section. In these circuits, the audio amplifier type 1U5 or 12AV6 has a 10-megohm resistor between the grid and the negative filament or cathode to furnish the required bias, which is usually less than 1 volt.

This method of biasing is used principally in the early voltage-amplifier stages (usually employing high- μ triodes) of audio amplifier circuits, where the tube dissipation will not be excessive under zero-signal conditions.

A grid resistor is also used in many oscillator circuits for obtaining the required bias. In these circuits, the grid voltage is relatively constant and its magnitude is usually in the order of 5 volts or more. Consequently, the bias voltage is obtained only through grid rectification. A relatively low value of resistor, 0.1 megohm or less, is used. Oscillator circuits employing this method of bias are given in the **Circuits** section.

Grid-bias variation for the rf and if amplifier stages is a convenient and frequently used method for controlling receiver volume. The variable voltage supplied to the grid may be obtained: (1) from a variable cathode resistor as shown in Figs. 114 and 115; (2) from a bleeder circuit by means of a potentiometer as shown in Fig. 116; or (3) from a bleeder circuit in which the bleeder current is varied by a tube

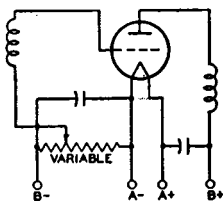

Fig. 114—Amplifier stage using a variable cathode-bias resistor for volume control.

used for automatic volume control. The latter circuit is shown in Fig. 61.

In all cases it is important that the control be arranged so that at no time will the bias be less than the recommended minimum grid-bias voltage for the particular tubes used. This requirement can be met by providing a fixed stop on the potentiometer, by connecting a fixed resistance in series with the variable resistance, or by con-

necting a fixed cathode resistance in series with the variable resistance used for regulation. Where receiver gain is

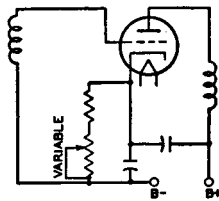

Fig. 115—Amplifier stage similar to Fig. 114 but using heater-cathode-type tube.

controlled by grid-bias variation, it is advisable to have the control voltages extend over a wide range in order to minimize cross-modulation and modulation-distortion. A remote-cutoff type of tube should, therefore, be used in the controlled stages.

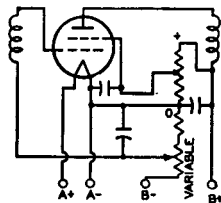

Fig. 116—Amplifier stage using a bleeder circuit and potentiometer for volume control.

In most tubes employing a unipotential cathode, a **positive grid current** begins to flow when the grid is slightly negative and increases rapidly as the grid is made more positive, as shown in Fig. 117. The value of grid voltage at which the grid-current curve intercepts the horizontal axis is determined by several different physical processes, including an electrothermal effect due to the differences in temperature and in material composition of the grid and the cathode, and by the positive grid current. For values of grid potentials which are larger than this intercept, the direction of the grid current is positive (*i.e.*, from the cathode to the grid). At smaller values of grid potential, the direction of the grid current

is negative (*i.e.*, from the grid to the cathode).

Positive grid current consists of electrons emitted from the cathode which are intercepted by the control grid. Negative grid current, which becomes appreciable only when the grid potential is more negative than the value of the intercept, is a result of the emission of electrons from the heated control grid to the cathode, the effect of gas molecules in the tube, and the influence of leakage currents between the grid and cathode and the grid and the plate.

The value of grid potential at the intercept of the grid-current curve on the horizontal axis (often mistakenly called **contact potential**) may be as high as $1\frac{1}{2}$ volts. If the operating bias of the tube is less than this intercept, it is found that two effects are present. Direct current flows in the grid circuit, and the dynamic input resistance of the tube may be relatively low. It is generally desirable to supply the tube with a value of bias sufficiently high so that the operating point of the tube is not near the value of this intercept. If the value of the operating bias is near the value of the intercept, care should be taken to avoid undesirable effects in the grid circuit due to grid current or low input resistance.

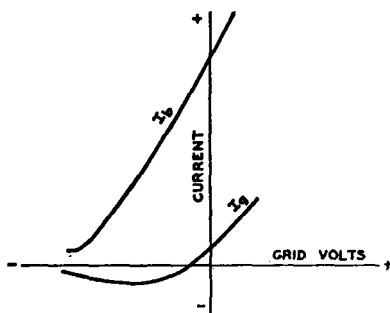

Fig. 117—Curves showing flow of positive grid current in tubes employing unipotential cathodes.

Screen-Grid Voltage Supply

The positive voltage for the screen grid (grid No. 2) of screen-grid tubes may be obtained from a tap on a voltage divider, from a potentiometer, or from a series resistor connected to a high-voltage source, depending on the particular tube type and its application. The screen-grid voltage for tetrodes should be obtained from a voltage divider or a potentiometer rather than through a series resistor from a high-voltage source because of the characteristic screen-grid current variations of tetrodes. Fig. 118 shows a tetrode with its screen-grid voltage obtained from a potentiometer.

When pentodes or beam power tubes are operated under conditions where a large shift of plate and screen-grid currents does not take place with the application of the signal, the screen-grid voltage may be obtained through a series resistor from a high-voltage

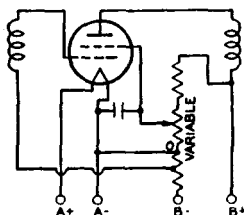

Fig. 118—Tetrode circuit in which screen-grid voltage is obtained from a potentiometer.

source. This method of supply is possible because of the high uniformity of the screen-grid current characteristic in pentodes and beam power tubes. Because the screen-grid voltage rises with increase in bias and resulting decrease in screen-grid current, the cutoff characteristic of a pentode is extended by this method of supply.

This method is sometimes used to increase the range of signals which can be handled by a pentode. When used in resistance-coupled amplifier circuits employing pentodes in combination

with the cathode-biasing method, it minimizes the need for circuit adjustments. Fig. 119 shows a pentode with its screen-grid voltage supplied through a series resistor.

When power pentodes and beam power tubes are operated under conditions such that there is a large change in plate and screen-grid currents with the application of signal, the series-resistor method of obtaining screen-grid voltage should not be used. A change in screen-grid current appears as a

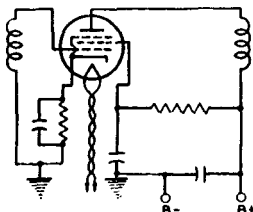

Fig. 119—Pentode circuit in which screen-grid voltage is supplied through a series resistor.

change in the voltage drop across the series resistor in the screen-grid circuit; the result is a change in the power output and an increase in distortion. The screen-grid voltage should be obtained from a point in the plate-voltage-supply filter system having the correct voltage, or from a separate source.

It is important to note that the plate voltage of tetrodes, pentodes, and beam power tubes should be applied before or simultaneously with the screen-grid voltage. Otherwise, with voltage on the screen grid only, the screen-grid current may rise high enough to cause excessive screen-grid dissipation.

Screen-grid voltage variation for the rf amplifier stages has sometimes been used for volume control in older-type receivers. Reduced screen-grid voltage decreases the transconductance of the tube and results in reduced gain per stage. The voltage variation is obtained by means of a potentiometer shunted across the screen-grid voltage supply. (See Fig. 118.) When the screen-grid voltage is varied, it must never

exceed the rating of the tube. This requirement can be met by providing a fixed stop on the potentiometer.

Shielding

In high-frequency stages having high gain, the output circuit of each stage must be shielded from the input circuit of that stage. Each high-frequency stage also must be shielded from the other high-frequency stages. Unless shielding is employed, undesired feedback may occur and may produce many harmful effects on receiver performance.

To prevent this feedback, it is a desirable practice to shield separately each unit of the high-frequency stages. For instance, in a superheterodyne receiver, each if and rf coil may be mounted in a separate shield can. Baffle plates may be mounted on the ganged tuning capacitor to shield each section of the capacitor from the other section. The oscillator coil may be especially well shielded by being mounted under the chassis.

The shielding precautions required in a receiver depend on the design of the receiver and the layout of the parts. In all receivers having high-gain high-frequency stages, it is necessary to shield separately each tube in high-frequency stages. When metal tubes, and in particular the single-ended types, are used, complete shielding of each tube is provided by the metal shell which is grounded through its grounding pin at the socket terminal. The grounding connection should be short and sturdy. Many modern tubes of glass construction have internal shields, usually connected to the cathode; where present, these shields are indicated in the socket diagram.

Dress of Circuit Leads

At high frequencies such as are encountered in FM and television receivers, lead dress, that is, the location and arrangement of the leads used for

connections in the receiver, is very important. Because even a short lead provides a large impedance at high frequencies, it is necessary to keep all high-frequency leads as short as possible. This precaution is especially important for ground connections and for all connections to bypass capacitors and high-frequency filter capacitors. The ground connections of plate and screen-grid bypass capacitors of each tube should be kept short and made directly to cathode ground.

Particular care should be taken with the lead dress of the input and output circuits of high-frequency stages so that the possibility of stray coupling is minimized. Unshielded leads connected to shielded components should be dressed close to the chassis. As the frequency increases, the need for careful lead dress becomes increasingly important.

In high-gain audio amplifiers, these same precautions should be taken to minimize the possibility of self-oscillation.

Filters

Feedback effects also are caused in radio or television receivers by coupling between stages through common voltage-supply circuits. Filters find an important use in minimizing such effects. They should be placed in voltage-supply leads to each tube in order to return the signal current through a low-impedance path direct to the tube cathode rather than by way of the voltage-supply circuit. Fig. 120 illustrates several forms of filter circuits. Capacitor C forms the low-impedance path, while the choke or resistor assists in diverting the signal through the capacitor by offering a high impedance to the power-supply circuit.

The choice between a resistor and a choke depends chiefly upon the permissible dc voltage drop through the filter. In circuits where the current is small (a few milliamperes), resistors are practical; where the current is large or

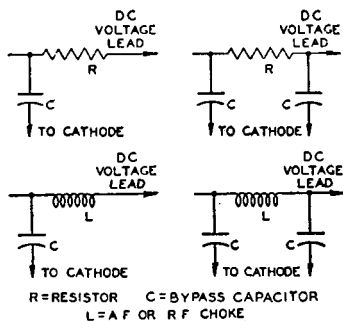

Fig. 120—Typical filter circuits.

regulation important, chokes are more suitable.

The minimum practical size of the capacitors may be estimated in most cases by the following rule: The impedance of the capacitor at the lowest frequency amplified should not be more than one-fifth of the impedance of the filter choke or resistor at that frequency. Better results will be obtained in special cases if the ratio is not more than one-tenth.

Radio-frequency circuits, particularly at high frequencies, require high-quality capacitors. Mica or ceramic capacitors are preferable. Where stage shields are employed, filters should be placed within the shield.

Another important application of filters is to smooth the output of a rectifier tube. (See **Rectification**.) A smoothing filter usually consists of capacitors and iron-core chokes. In any filter-design problem, the load impedance must be considered as an integral part of the filter because the load is an important factor in filter performance. Smoothing effect is obtained from the chokes because they are in series with the load and offer a high impedance to the ripple voltage. Smoothing effect is obtained from the capacitors because they are in parallel with the load and store energy on the voltage peaks; this energy is released on the voltage dips and serves to maintain the voltage at the load substantially

constant. Smoothing filters are classified as choke-input or capacitor-input according to whether a choke or capacitor is placed next to the rectifier tube. (See Fig. 121.)

plate and transformer winding and to connect high-voltage, rf bypass capacitors between the outside ends of the tap of the secondary and the center tap. (See Fig. 122.) The rf chokes should

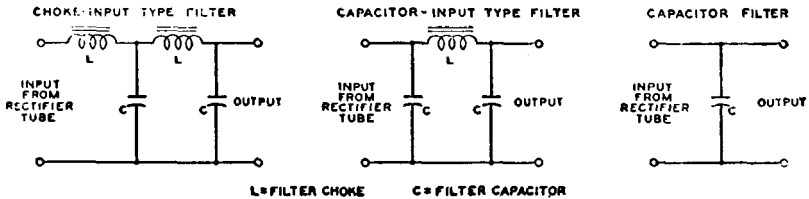

Fig. 121—Typical smoothing filters for rectifier tubes.

The **Circuits** section gives a number of examples of rectifier circuits with recommended filter constants.

If an input capacitor is used, consideration must be given to the instantaneous peak value of the ac input voltage. This peak value is about 1.4 times the rms value as measured by an ac voltmeter. Filter capacitors, therefore, especially the input capacitor, should have a rating high enough to withstand the instantaneous peak value if breakdown is to be avoided. When the input-choke method is used, the available dc output voltage will be somewhat lower than with the input-capacitor method for a given ac plate voltage. However, improved regulation together with lower peak current will be obtained.

Mercury-vapor and gas-filled rectifier tubes occasionally produce a form of local interference in radio receivers through direct radiation or through the power line. This interference is generally identified in the receiver as a broadly tunable 120-Hz buzz (100 Hz for 50-Hz supply line, etc.). It is usually caused by the formation of a steep wave front when plate current within the tube begins to flow on the positive half of each cycle of the ac supply voltage.

There are several ways of eliminating this type of interference. One is to shield the tube. Another is to insert an rf choke having an inductance of one millihenry or more between each

be placed within the shielding of the tube. The rf bypass capacitors should have a voltage rating high enough to withstand the peak voltage of each half of the secondary, which is approximately 1.4 times the rms value.

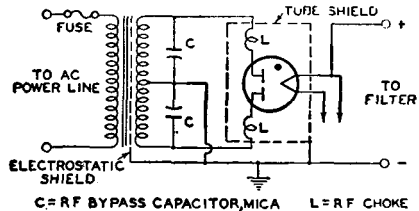

Fig. 122—Filter circuit used to eliminate interference produced by mercury-vapor or gas-filled rectifier tubes.

Transformers having electrostatic shielding between primary and secondary are not likely to transmit rf disturbances to the line. Often the interference may be eliminated simply by making the plate leads of the rectifier extremely short. In general, the particular method of interference elimination must be selected by experiment for each installation.

Output Coupling Devices

An output-coupling device is used in the plate circuit of a power output tube to keep the comparatively high dc plate current from the winding of an electromagnetic speaker and, also, to

transfer power efficiently from the output stage to a loudspeaker of either the electromagnetic or dynamic type.

Output-coupling devices are of two types, (1) choke-capacitor and (2) transformer. The choke-capacitor type includes an iron-core choke having an inductance of not less than 10 henries which is placed in series with the plate and B-supply. The choke offers a very low resistance to the dc plate current component of the signal voltage but opposes the flow of the fluctuating component. A bypass capacitor of 2 to 6 microfarads supplies a path to the speaker winding for the signal voltage. The choke-coil output coupling device, however, is now only of historical interest.

The transformer type is constructed with two separate windings, a primary and a secondary wound on an iron core. This construction permits designing each winding to meet the requirements of its position in the circuit. Typical arrangements of each type of coupling device are shown in Fig. 123. Examples of transformers for push-pull stages are shown in several of the circuits given in the **Circuits** section.

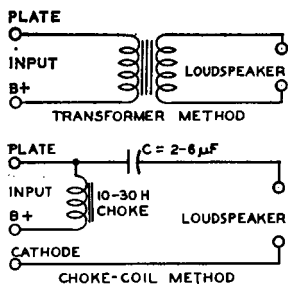

Fig. 123—Typical output-coupling devices.

High-Fidelity Systems

The results achieved from any high-fidelity amplifier system depend to a large degree upon the skill and care with which the system is constructed. Improper placement of transformers, other components, and wiring, and attempts to achieve excessive compact-

ness, can only result in instability, oscillation, hum, and other operating difficulties, as well as in damage to components by overheating. It is important, therefore, that construction of high-fidelity amplifier systems be undertaken only by persons who have had some experience in the layout, mechanical construction, and wiring of audio equipment.

It is impractical to give specific construction data for various amplifiers and supplementary units because the best arrangement of units will depend on the requirements of the user. It is possible, however, to list some general considerations which should be observed in the construction of any high-fidelity amplifier system.

Any amplifier having two or more stages should be constructed with a straight-line layout so that maximum separation is provided between the signal input and output circuits and terminals. Power-supply connections, particularly those carrying ac, should be isolated as far as possible from signal connections, especially from the input connection. Signal-carrying conductors, even when shielded, should not be cabled together with power-supply conductors. Internal wiring for ac-operated tube heaters, switches, pilot-light sockets, and other devices, should be twisted and placed flat against the chassis. All connections to the ground side of the circuit in each unit should be made to a common bus of heavy wire. This bus should be connected to the chassis only at the point of minimum signal voltage, *i.e.*, at the signal-input terminal of the unit.

All internal wiring that carries signal voltages should be as short as possible, and as far as possible above the chassis, to minimize losses at the higher audio frequencies due to stray shunt capacitance. All connections between units should be made with shielded cable having a capacitance of not more than 30 picofarads per foot, such as Alpha Type 1249 or 1704, Belden Type 8401 or 8410, or equivalent cable.

Because power amplifiers and power-supply units of high-fidelity systems normally dissipate large amounts of heat, they should be constructed and installed in such a manner as to assure adequate ventilation for the tubes and other components. A beam power tube or rectifier tube should be separated from any other tube or component on the same side of the chassis by at least $1\frac{1}{2}$ tube diameters.

Power amplifiers and power-supply units which are to be installed horizontally (*i.e.*, with the tubes vertical) in cabinets or on shelves should be provided with mounting feet, perforated bottom covers, and a number of small holes around each tube socket to permit relatively cool air to enter from below and provide ventilation for the under side of the chassis and tubes.

If a power amplifier, tone-control amplifier, and one or more preamplifiers are to be constructed on the same chassis, the mechanical layout should be planned so that the circuits operating at the lowest signal levels are farthest from the output stage and power supply. Amplifier units which normally operate at comparable signal levels but are not used simultaneously (such as preamplifiers for tape pickup heads and magnetic phonograph pickups) may be installed side by side on the same chassis without danger of interaction. Units which operate simultaneously, however (such as the channels of a stereophonic system), should not be installed side by side on the same chassis without careful consideration to placement of components and wiring, and the possible use of shielding to prevent interaction.

When an amplifier, preamplifier, mixer, or other unit requiring heater power is located more than five or six feet from its power-supply unit, the heater-current conductors in the power-supply cable must be large enough to assure that each tube receives its rated heater voltage. In cases where very large heater currents or very long power-supply cables are involved, it may be desirable to install a heater-

supply transformer on or near the amplifier unit. If such a transformer is installed on or near a preamplifier for a magnetic-tape pickup head, a magnetic phonograph pickup, or a dynamic microphone, the transformer should be completely shielded and positioned to prevent its field from inducing hum in the pickup device.

Considerations for Television Picture Tubes

Like other high-voltage devices, television picture tubes require that certain precautions be observed to minimize the possibility of failure caused by humidity, dust, and corona.

Humidity Considerations. When humidity is high, a continuous film of moisture may form on the glass bulb immediately surrounding the anode cavity cap of all-glass picture tubes or on the glass part of the envelope of metal picture tubes. This film may permit sparking to take place over the glass surface to the external conductive coating or to the metal shell. Such sparking may introduce noise into the receiver. To prevent such a possibility, the uncoated bulb surface around the cap and the glass part of the envelope of metal picture tubes should be kept clean and dry.

Dust Considerations. The accumulation of dust on the uncoated area of the bulb around the anode cap of all-glass picture tubes or on the glass part of the envelope or insulating supports for metal picture tubes will decrease the insulating qualities of these parts. The dust usually consists of fibrous materials and may contain soluble salts. The fibers absorb and retain moisture; the soluble salts provide electrical leakage paths that increase in conductivity as the humidity increases. The resulting high leakage currents may overload the high-voltage power supply.

It is recommended, therefore, that the uncoated bulb surface of all-glass picture tubes and the coated glass sur-

face and insulating supports for metal picture tubes be kept clean and free from dust or other contamination such as finger-prints. The frosted Filterglass faceplate of the metal picture tubes may be cleaned with a soapless detergent, such as Dreft, then rinsed with clean water, and immediately dried.

Corona Considerations. A high-voltage system may be subject to corona, especially when the humidity is high, unless suitable precautions are taken. Corona, which is an electrical discharge appearing on the surface of a conductor when the voltage gradient exceeds the breakdown value of air, causes deterioration of organic insulating materials through formation of ozone, and induces arc-over at points and sharp edges. Sharp points or other irregularities on any part of the high-

voltage system may increase the possibility of corona and should be avoided.

In the metal-shell picture tubes, the metal lip at the maximum diameter has rounded edges to prevent corona. Adequate spacing between the lip and any grounded element in the receiver, or between the small end of the metal shell and any grounded element, should be provided to preclude the possibility of corona. Such spacing should not be less than 1 inch of air. Similarly, an air space of 1 inch, or equivalent, should be provided around the body of the metal shell. As a further precaution to prevent corona, the deflecting-yoke surface on the end adjacent to the shell should present a smooth electrical surface with respect to the small end of the metal shell or the anode terminal of all-glass tubes.

Safety Precautions

Shock Hazard and High Voltage Warning—Receiving Tubes

Most electron tubes present a shock hazard in use because of the voltages at which they operate. This hazard applies to all applications and is not restricted to high-voltage circuits. Therefore, precautions should be taken when servicing equipment in which electron tubes are used.

Some electron tubes, such as high-voltage rectifiers and those used in the high-voltage regulators of television receivers, operate with very high electrode voltages. Extreme care should be taken during testing or adjustment of circuits in which such tubes are employed. Precautions must be exercised during the replacement or servicing of these tubes in equipment to assure that the high voltage output terminal is properly grounded when the tube is being removed from or inserted into its socket or when the top cap connector is being disconnected or connected. The tube and its associated apparatus, especially all parts which may be at high-potential with respect to ground, should be housed in a protective enclosure. The protective housing should be designed with interlocks so that personnel cannot possibly come in contact with any high-potential point in the electrical system.

It should be noted that high voltages may appear at normally low-potential points in the circuit as a result of capacitor breakdown or incorrect circuit connections. Therefore, before any part of the circuit is touched, the power supply switch should be turned off and both terminals of any capacitor should be grounded.

X-Radiation Warning—Receiving Tubes

Electron tubes that are operated at potentials exceeding several thousand volts may emit X-radiation. The X-radiation is generated when electrons (or ions) which are accelerated to high velocities impact with high energy on various parts of the tube's structure. Tube types which specify an X-radiation characteristic in their published data are designed and controlled for this characteristic.

X-Radiation is measured in accordance with JEDEC Publication No. 67A, "Recommended Practice for Measurement of X-Radiation from Receiving Tubes", and controlled in accordance with JEDEC Publication No. 73A, "Recommended Practice for Quality Control of X-Radiation from High Voltage Rectifier and Shunt Regulator Receiving Tubes". These publications are available from the Electronic Industries Association, 2001 Eye St., N.W., Washington, D.C. 20006.

Operation of these devices above the maximum values indicated in their Maximum Ratings may result in either temporary or permanent changes in the X-radiation characteristic of the tube. Equipment design must be such that these maximum values are not exceeded.

The high voltages associated with these devices result in production of X-radiation which may constitute a health hazard on prolonged exposure at close range unless the tube is adequately shielded. Equipment design must provide for this shielding.

Precautions must be exercised during the servicing of equipment employ-

ing these devices to assure that the high voltage is adjusted to the recommended value and that any shielding components are replaced to their intended positions before the equipment is operated.

Shock Hazard Warning— Picture Tubes

The high voltage at which picture tubes are operated may be very dangerous. Design of the TV receiver should include safeguards to prevent the user from coming in contact with the high voltage. Extreme care should be taken in the servicing or adjustment of any high-voltage circuit.

Caution must be exercised during the replacement or servicing of the picture tube since a residual electrical charge may be contained on the high voltage capacitor formed by the external and internal conductive coatings of the picture tube funnel. To remove any undesirable residual high voltage charges from the picture tube, "bleed off" the charge by shorting the anode contact button, located in the funnel of the picture tube, to the external conductive coating before handling the tube. Discharging the high voltage to isolated metal parts such as cabinets and control brackets may produce a shock hazard.

Tube Handling Precaution— Picture Tubes

Picture tubes should be kept in the shipping box or similar protective container until just prior to installation. Wear heavy protective clothing, including gloves and safety goggles with side shields, in areas containing unpacked and unprotected tubes to prevent possible injury from flying glass in the event a tube breaks. Handle the picture tube with extreme care. Do not strike, scratch, or subject the tube to

more than moderate pressure. On types having an integral safety panel, particular care should be taken to prevent damage to the seal area and the edge of the integral safety panel.

Implosion Protection— Picture Tubes

Picture tubes which employ integral implosion protection must be replaced with a tube of the same type number or an RCA recommended replacement to assure continued safety.

X-Radiation Warning— Picture Tubes

High-voltage electron tubes that operate at potentials exceeding several thousand volts may emit X-radiation. Operation of a television picture tube at abnormal conditions may produce X-radiation in excess of design limits.

X-Radiation is measured in accordance with JEDEC Publication No. 64C, "Recommended Practice for Measurement of X-Radiation from Direct-View Television Picture Tubes." This publication is available from the Electronics Industries Association, 2001 Eye St., N.W., Washington, D. C. 20006.

For radiation safety when servicing a television receiver, it is essential to adjust the high voltage, using an accurate and reliable high-voltage meter, to the value specified by the set manufacturer following his recommended procedure. It is also essential that all external shields are properly replaced. In servicing a television receiver that requires a replacement picture tube, a tube with the same type number or an RCA recommended replacement tube type should be used to assure the same or improved integral X-radiation shielding.

Interpretation of Tube Data

THE tube data given in the following **Technical Data** section include ratings, typical operation values, characteristics, and characteristic curves.

The values for grid-bias voltages, other electrode voltages, and electrode supply voltages are given with reference to a specified **datum point** as follows: For types having filaments heated with dc, the negative filament terminal is taken as the datum point to which other electrode voltages are referred. For types having filaments heated with ac, the mid-point (*i.e.*, the center tap on the filament-transformer secondary, or the mid-point on a resistor shunting the filament) is taken as the datum point. For types having unipotential cathodes indirectly heated, the cathode is taken as the datum point.

Ratings are established on electron tube types to help equipment designers utilize the performance and service capabilities of each tube type to best advantage. Ratings are given for those characteristics which careful study and experience indicate must be kept within certain limits to insure satisfactory performance.

Three rating systems are in use by the electron-tube industry. The oldest is known as the Absolute Maximum system, the next as the Design Center system, and the latest and newest as the Design Maximum system. Definitions of these systems have been formulated by the Joint Electron Device Engineering Council (JEDEC) and standardized by the National Electrical Manufacturers Association (NEMA) and the Electronic Industries Association (EIA) as follows:

Absolute Maximum ratings are limiting values which should not be exceeded with any tube of the specified type under any condition of operation. These ratings are not used too often for receiving types, but are generally used for transmitting and industrial types.

Design Center ratings are limiting values which should not be exceeded with a tube of the specified type having characteristics equal to the published values under normal operating conditions. These ratings, which include allowances for normal variations in both tube characteristics and operating conditions, were used for most receiving tubes prior to 1957.

Design Maximum ratings are limiting values which should not be exceeded with a tube of the specified type having characteristics equal to the published values under any conditions of operation. These ratings include allowances for normal variations in tube characteristics, but do not provide for variations in operating conditions. Design Maximum ratings were adopted for receiving tubes in 1957.

Electrode voltage and current ratings are in general self-explanatory, but a brief explanation of other ratings will aid in the understanding and interpretation of tube data.

Heater warm-up time is defined as the time required for the voltage across the heater to reach 80 per cent of the rated value in the circuit shown in Fig. 124. The heater is placed in series with a resistance having a value 3 times the nominal heater operating resistance

($R = 3 E_r / I_r$), and a voltage having a value 4 times the rated heater voltage ($V = 4 E_r$) is then applied. The warm-up time is determined when $E = 0.8 E_r$.

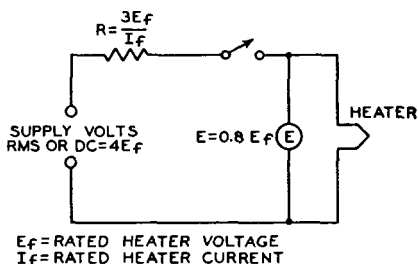

Fig. 124—Test circuit for measuring heater warm-up time.

Plate dissipation is the power dissipated in the form of heat by the plate as a result of electron bombardment. It is the difference between the power supplied to the plate of the tube and the power delivered by the tube to the load.

Peak heater-cathode voltage is the highest instantaneous value of voltage that a tube can safely stand between its heater and cathode. This rating is applied to tubes having a separate cathode terminal and used in applications where excessive voltage may be introduced between heater and cathode.

Maximum dc output current is the highest average plate current which can be handled continuously by a rectifier tube. Its value for any rectifier tube type is based on the permissible plate dissipation of that type. Under operating conditions involving a rapidly repeating duty cycle (steady load), the average plate current may be measured with a dc meter.

The nomograph shown in Fig. 125 can be used to determine tube voltage drop or plate current for any diode unit when values for a single plate-voltage, plate-current condition are available from the data. It can also be used to compare the relative perveance ($G = I_b / E_b^{3/2}$) of several diodes. **Perveance** can be considered a figure of merit for diodes; high-perveance units have

lower voltage drop at a fixed current level.

Tube voltage drop or plate current for a specific diode unit can be determined as follows: First, convenient values are selected for the plate-voltage and plate-current scales of the nomograph. The published plate-current and plate-voltage values are then located on the scales and connected with a straight edge. The intersection of the connecting line with the perveance scale is then used as a pivot point to determine the value of tube voltage drop corresponding to a desired current value, or the value of plate current corresponding to a desired tube voltage drop. Because the pivot point for a specific diode

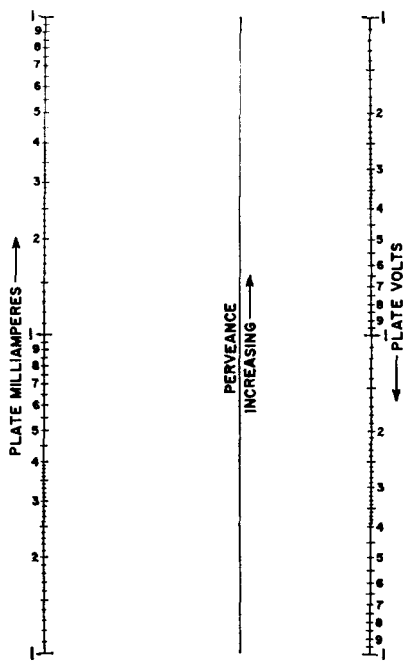

92CM-11244

Fig. 125—Diode perveance nomograph.

unit represents its perveance, the pivot points for several units (plotted to the same scales) can be used to compare their relative perveance.

For example, type 5U4GB has a tube voltage drop (per plate) of 44 volts at a plate current of 225 milliamperes. Convenient scales for this type are from 1 to 100 volts for plate voltage and from 10 to 1000 milliamperes for plate current. The points 44 volts and 225 milliamperes are then connected with a straight line to determine the pivot point. Using this pivot point, it is easy to determine such values as a plate current of 150 milliamperes at a tube voltage drop of 33 volts, or a voltage drop of 25 for a current of 100 milliamperes.

For readings in the order of one volt and/or one milliampere, the nomograph is not accurate because of the effects of contact potential and initial electron velocity.

Maximum peak plate current is the highest instantaneous plate current that a tube can safely carry recurrently in the direction of normal current flow. The safe value of this peak current in hot-cathode types of rectifier tubes is a function of the electron emission available and the duration of the pulsating current flow from the rectifier tube in each half-cycle.

The value of peak plate current in a given rectifier circuit is largely determined by filter constants. If a large choke is used at the filter input, the peak plate current is not much greater than the load current; but if a large capacitor is used as the filter input, the peak current may be many times the load current. In order to determine accurately the peak plate current in any rectifier circuit, measure it with a peak-indicating meter or use an oscillograph.

Maximum peak inverse plate voltage is the highest instantaneous plate voltage which the tube can withstand recurrently in the direction opposite to that in which it is designed to pass current. For mercury-vapor tubes and gas-filled tubes, it is the safe top value to prevent arc-back in the tube operating within the specified temperature range.

Referring to Fig. 126, when plate A of a full-wave rectifier tube is positive, current flows from A to C, but not from B to C, because B is negative. At the

instant plate A is positive, the filament is positive (at high voltage) with respect to plate B. The voltage between the positive filament and the negative plate B is in inverse relation to that causing current flow. The peak value of this voltage is limited by the resistance and nature of the path between plate B and filament. The maximum value of this voltage at which there is no danger of breakdown of the tube is known as maximum peak inverse voltage.

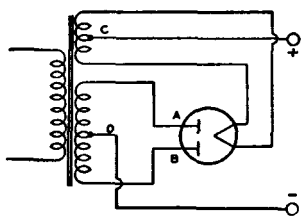

Fig. 126—Schematic diagram of full-wave rectifier tube and circuit connections.

The relations between peak inverse voltage, rms value of ac input voltage, and dc output voltage depend largely on the individual characteristics of the rectifier circuit and the power supply. The presence of line surges or any other transient, or wave-form distortion, may raise the actual peak voltage to a value higher than that calculated for sine-wave voltages. Therefore, the **actual** inverse voltage, and not the calculated value, should be such as not to exceed the rated maximum peak inverse voltage for the rectifier tube. A calibrated cathode-ray oscillograph or a peak-indicating electronic voltmeter is useful in determining the actual peak inverse voltage.

In single-phase, full-wave circuits with sine-wave input and with no capacitor across the output, the peak inverse voltage on a rectifier tube is approximately 1.4 times the rms value of the plate voltage applied to the tube. In single-phase, half-wave circuits with sine-wave input and with capacitor input to the filter, the peak inverse voltage may be as high as 2.8 times the rms value of the applied plate voltage.

In polyphase circuits, mathematical determination of peak inverse voltage requires the use of vectors.

The **Rating Chart** for full-wave rectifiers presents graphically the relationships between maximum ac voltage input and maximum dc output current derived from the fundamental ratings for conditions of capacitor-input and choke-input filters. This graphical presentation provides for considerable latitude in choice of operating conditions.

The **Operation Characteristics** for a full-wave rectifier with capacitor-input filter show by means of boundary line the limiting current and voltage relationships presented in the Rating Chart.

The **Operation Characteristics** for a full-wave rectifier with choke-input filter not only show by means of boundary line the limiting current and voltage relationships presented in the Rating Chart, but also give some information as to the effect on regulation of various sizes of chokes. The solid-line curves show the dc voltage outputs which would be obtained if the filter chokes had infinite inductance. The long-dash lines radiating from the zero position are boundary lines for various sizes of chokes as indicated. The intersection of one of these lines with a solid-line curve indicates the point on the curve at which the choke no longer behaves as though it had infinite inductance. To the left of the choke boundary line, the regulation curves depart from the solid-line curves as shown by the representative short-dash regulation curves.

Typical Operation Values. Values for typical operation are given for many types in the **Technical Data** section. These typical operating values are given to serve as guiding information for the use of each type. These values should not be confused with ratings, because a tube can be used under any suitable conditions within its maximum ratings, according to the application.

The power output value for any operating condition is an approximate

tube output—that is, plate input minus plate loss. Circuit losses must be subtracted from tube output in order to determine the useful output.

Characteristics are covered in the **Electron Tube Characteristics** section and such data should be interpreted in accordance with the definitions given in that section. **Characteristic curves** represent the characteristics of an average tube. Individual tubes, like any manufactured product, may have characteristics that range above or below the values given in the characteristic curves.

Although some curves are extended well beyond the maximum ratings of the tube, this extension has been made only for convenience in calculations. Do NOT operate a tube outside of its maximum ratings.

Interelectrode capacitances are direct capacitances measured between specified elements or groups of elements in electron tubes. Unless otherwise indicated in the data, all capacitances are measured with filament or heater cold, with no direct voltages present, and with no external shields. All electrodes other than those between which capacitance is being measured are grounded. In twin or multi-unit types, inactive units are also grounded.

The capacitance between the input electrode and all other electrodes, except the output electrode, connected together is commonly known as the input capacitance. The capacitance between the output electrode and all other electrodes, except the input electrode, connected together is known as the output capacitance.

Hum and noise characteristics of high-fidelity audio amplifier tube types such as the 7025 and the 7199 are tested in an amplifier circuit such as that shown in Fig. 127. The output of the test circuit is fed into a low-noise amplifier. The bandwidth of this amplifier depends on the characteristic being measured. If hum alone is being tested, a relatively narrow bandwidth is used to include both the line frequency and

the major harmonics generated by the tube under test. In noise or combination hum-and-noise measurements, the bandwidth is defined in the registration of the tube type.

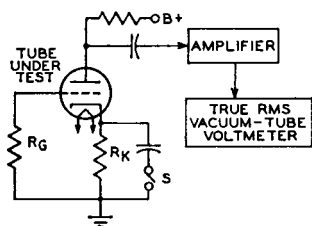

Fig. 127—Test circuit for measuring hum and noise characteristics of high-fidelity audio-amplifier tubes.

The amplifier gain is calibrated so that the vacuum-tube voltmeter measures hum and noise in microvolts referenced to the grid of the tube under test. A pentode can also be evaluated in this manner by the addition of a screen-grid supply adequately bypassed at the tube screen-grid pin connection. Power-supply ripple at the plate of the tube under test must be negligible compared to its hum and noise output. Extraordinary shielding of both the test socket and the associated operating circuit is required to minimize capacitances between heater leads and high-impedance connections.

The test-circuit components are determined by the tube type being tested and the type of hum to be controlled. Heater-cathode hum can be eliminated from the measurement by closing the switch S. The circuit can also be made more or less sensitive to heater-grid hum by increasing or decreasing the grid resistance R_g . No circuit changes affect the component of magnetic hum generated by the tube.

Grid-No. 2 (Screen-grid) Input is the power applied to the grid-No. 2 electrode and consists essentially of the power dissipated in the form of heat by grid No. 2 as a result of electron bombardment. With tetrodes and pentodes, the power dissipated in the screen-grid circuit is added to the power in the plate circuit to obtain the total B-supply input power.

When the screen-grid voltage is supplied through a series voltage-dropping resistor, the maximum screen-grid voltage rating may be exceeded, provided the maximum screen-grid dissipation rating is not exceeded at any signal condition, and the maximum screen-grid voltage rating is not exceeded at the maximum-signal condition. Provided these conditions are fulfilled, the screen-grid supply voltage may be as high as, but not above, the maximum plate voltage rating. The rating chart on page 300 shows the relationship between the maximum permissible input power to the screen grid and the screen-grid supply voltage.

Electron Tube Testing

THE electron-tube user—service-man, experimenter, or non-technical radio listener—is interested in knowing the condition of his tubes, since they govern the performance of the device in which they are used. In order to determine the condition of a tube, some method of test is necessary. Because the operating capabilities and design features of a tube are indicated and described by its electrical characteristics, a tube is tested by measuring its characteristics and comparing them with values established as standard for that type. Tubes which read abnormally high with respect to the standard for the type are subject to criticism just the same as tubes which are too low.

Certain practical limitations are placed on the accuracy with which a tube test can be correlated with actual tube performance. These limitations make it impractical for the service man and dealer to employ complex and costly testing equipment having laboratory accuracy. Because the accuracy of the tube-testing device need be no greater than the accuracy of the correlation between test results and receiver performance, and since certain fundamental characteristics are virtually fixed by the manufacturing technique of leading tube manufacturers, it is possible to employ a relatively simple test in order to determine the serviceability of a tube.

In view of these factors, dealers and servicemen will find it economically expedient to obtain adequate accuracy and simplicity of operation by employing a device which indicates the status of a single characteristic. Whether the tube is satisfactory or unsatisfactory is judged from the test result of this single characteristic. Consequently, it is very desirable that the characteristic selected for the test be one which is truly representative of the tube's over-all condition.

The following information and cir-

cuits are given to describe and illustrate general theoretical and practical tube-tester considerations and not to provide information on the construction of a home-made tube tester. In addition to the problem of determining what tube characteristic is most representative of performance capabilities in all types of receivers, the designer of a home-made tester faces the difficult problem of determining satisfactory limits for his particular tester. Getting information of this nature, if it is to be accurate and useful, is a big job. It requires the testing of many tubes of each type, testing of many types, and correlation of the data with performance in many kinds of equipment.

Short-Circuit Test

The fundamental circuit of a short-circuit tester is shown in Fig. 128. Although this circuit is suitable for tet-

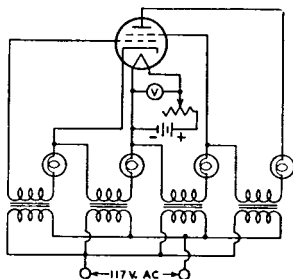

Fig. 128—Fundamental circuit of a short circuit tester.

rodes and types having less than four electrodes, tubes of more electrodes may be tested by adding more indicator lamps to the circuit. Voltages are applied between the various electrodes with lamps in series with the electrode leads. The value of the voltages applied will depend on the type of tube being tested and its maximum ratings. Any two shorted electrodes complete a circuit and light one or more lamps. Since two electrodes may be just touching to give a high-resistance short, it is de-

sirable that the indicating lamps operate on very low current. It is also desirable to maintain the filament or heater of the tube at its operating temperature during the short-circuit test, because short-circuits in a tube may sometimes occur only when the electrodes are heated. However, a short-circuit tester having too high a sensitivity may indicate very-high-resistance shorts that do not adversely affect tube operation.

Selection of a Suitable Characteristic for Test

Some characteristics of a tube are far more important in determining its operating worth than are others. The cost of building a device to measure any one of the more important characteristics may be considerably higher than that of a device which measures a less representative characteristic. Consequently, three methods of test will be discussed, ranging from relatively simple and inexpensive equipment to more elaborate, more accurate, and more costly devices.

An emission test is perhaps the simplest method of indicating a tube's condition. (Refer to *Diodes*, in **Electrons, Electrodes, and Electron Tubes** section, for a discussion of electron emission.) Since emission falls off as the tube wears out, low emission is indicative of the end of tube serviceability. However, the emission test is subject to limitations because it tests the tube under static conditions and does not take into account the actual operation of the tube. On the one hand, coated filaments, or cathodes, often develop active spots from which the emission is so great that the relatively small grid area adjacent to these spots cannot control the electron stream. Under these conditions, the total emission may indicate the tube to be normal although the tube is unsatisfactory. On the other hand, coated types of filaments are capable of such large emission that the tube will often operate satisfactorily after the emission has fallen far below the original value.

Fig. 129 shows the fundamental

circuit diagram for an emission test. All of the electrodes of the tube, except the cathode, are connected to the plate. The filament, or heater, is operated at rated voltage; after the tube has reached con-

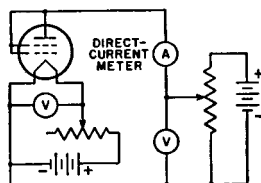

Fig. 129—Fundamental circuit of an emission tester

stant temperature, a low positive voltage is applied to the plate and the electron emission is read on the meter. Readings which are well below the average for a particular tube type indicate that the total number of available electrons has been so reduced that the tube is no longer able to function properly.

A transconductance test takes into account a fundamental operating principle of the tube. (This fact will be seen from the definition of transconductance in the Section on **Electron Tube Characteristics**.) It follows that transconductance tests, when properly made, permit better correlation between test results and actual performance than does a straight emission test.

There are two forms of transconductance test which can be utilized in a tube tester. In the first form (illustrated by Fig. 130 giving a fundamental circuit with a tetrode under test), appropriate

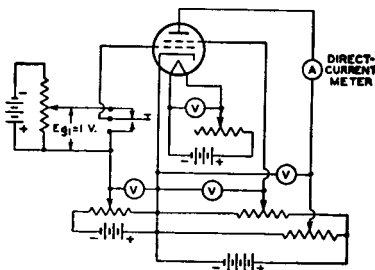

Fig. 130—Fundamental circuit of a transconductance tester using the "grid-shift" method.

operating voltages are applied to the electrodes of the tube. A plate current depending upon the electrode voltages will then be indicated by the meter. If the bias on the grid is then shifted by the application of a different grid voltage, a new plate-current reading is obtained. The difference between the two plate-current readings is indicative of the transconductance of the tube. This method of transconductance testing is commonly called the "grid-shift" method, and depends on readings under static conditions. The fact that this form of test is made under static conditions imposes limitations not encountered in the second form of test made under dynamic conditions.

The dynamic transconductance test illustrated in Fig. 131 gives a fundamental circuit with a tetrode under test. This method is superior to the static transconductance test in that ac voltage

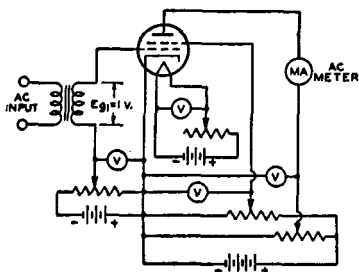

Fig. 131—Fundamental circuit of a dynamic transconductance tester.

is applied to the grid. Thus, the tube is tested under conditions which approximate actual operating conditions. The alternating component of the plate current is read by means of an ac ammeter of the dynamometer type. The transconductance of the tube is equal to the ac plate current divided by the input-signal voltage. If a one-volt rms signal is applied to the grid, the plate-current-meter reading in milliamperes multiplied by one thousand is the value of transconductance in micromhos.

The **power-output test** probably gives the best correlation between test results and actual operating performance of a tube. In the case of voltage amplifiers, the power output is indicative of the amplification and output

voltages obtainable from the tube. In the case of power-output tubes, the performance of the tube is closely checked. Consequently, although more complicated to set up, the power-output test will give closer correlation with actual performance than any other single test.

Fig. 132 shows the fundamental circuit of a power-output test for class A operation of tubes. The diagram illustrates the method for a pentode. The ac output voltage developed across the

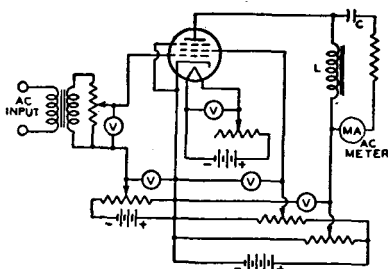

Fig. 132—Fundamental circuit of a power-output tester for class A operation of tubes.

plate-load impedance (L) is indicated by the current meter. The current meter is isolated as far as the dc plate current is concerned by the capacitor (C). The power output can be calculated from the current reading and known load resistance. In this way, it is possible to determine the operating condition of the tube quite accurately.

Fig. 133 shows the fundamental circuit of a power-output test for class

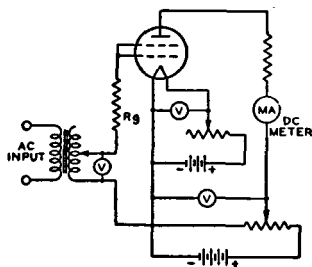

Fig. 133—Fundamental circuit of a power-output tester for class B operation of tubes.

B operation of tubes. With ac voltage applied to the grid of the tube, the current in the plate circuit is read on a dc milliammeter. The power output

of the tube is approximately equal to:

$$(I_b^2 \times R_L)/0.405,$$

where P_o is the power output in watts, I_b is the dc current in amperes, and R_L is the load resistance in ohms.

Essential Tube-Tester Requirements

1. The tester should provide for making a short-circuit test before measurement of the tube's characteristics.

2. It is important that some means of controlling the voltages applied to the electrodes of the tube be provided. If the tester is ac operated, a line-voltage control permits the supply of proper electrode voltages.

3. It is essential that the rated voltage applied to the filament or heater be maintained accurately.

4. It is suggested that the characteristics test follow one of the methods described. The method selected and the quality of the parts used in the test will depend upon the user's requirements.

Tube-Tester Limitations

A tube tester can only indicate the difference between a tube characteristic and those which are standard for that type. Because the operating conditions imposed upon a tube may vary within wide limits, it is impossible for a tube tester to evaluate tubes for all applications.

Commercially available tube checkers vary widely in purpose, performance, and significance of results. They range from relatively inexpensive portable units to costly laboratory-quality instruments. Design trade-offs are made by tube checker manufacturers to provide a product simple to operate, capable of testing a wide variety of tube types, and in some cases, low in cost. Accuracy of readings, completeness of testing, and even proper testing conditions for certain tube types are sometimes sacrificed in these trade-offs. Recognition of the individual tester limitations are absolutely necessary before valid judgments on tube quality can be made from test results.

Tube checkers generally make two types of evaluations: tests for inter-

element shorts (leakage) and an electrical test of quality that is either an ac cathode-emission test or a more complex large-signal transconductance test.

The shorts or leakage tests are often more sensitive than those of the tube manufacturer and also, in some cases more stringent than circuit application requirements. Leakage sensitivity of 100 megohms between elements is available in some tube checkers. Some can be adjusted by the user to even higher sensitivities. Many tube checkers tie several elements together to test many parallel paths in a single test position. As a result, multiple paths having individual inter-element leakage resistances which are acceptable result in parallel combinations which cause the tube to read as defective.

Quality-test interpretations must be tempered by knowledge of the character of the quality test. Large-signal transconductance (g_m) often does not correlate with small-signal transconductance, or the control limits for applications that require this characteristic. Cathode emission, as read on many tube checkers, is a function of both the emitting capability of the cathode and the mechanical spacing of the tube's internal parts. While high cathode emitting capability is generally desirable for all tubes, a high emission reading obtained by close mechanical spacing of parts can result in a false indication of good quality. In addition, high or low indications in a tube checker are often caused by compromise test conditions rather than the quality of the tube being tested.

The set-up instruction and charts furnished by the tester manufacturer establish the conditions and limits which the tester manufacturer considers adequate for the tube types evaluated. These conditions and limits are usually established independently of the tube manufacturer and without consideration of application requirements.

The tube tester cannot be looked upon as a final authority in determining whether or not a tube is satisfactory. An actual operating test in the application will give the best possible indication of a tube's worth.

Application Guide for RCA Receiving Tubes

In the Application Guide on the following pages, RCA receiving tubes are classified in two ways: (a) by function, and (b) by structure (diode, triode, etc.). The functional classification covers 27 principal types of application, as listed below.

Tube types are grouped by structure under each classification; they are also keyed to indicate miniature, octal, nuvistor, duodecar, and novar types.

Triodes are designated as *low-*, *medium-*, or *high-mu* types on the following basis: *low*, less than 10; *medium*, 10 or more, but less than 50; *high*, 50

or more. Where applicable, tubes are designated as *sharp-*, *semiremote-*, or *remote-cutoff* on the basis of the ratio, in per cent, of the negative control-grid voltage to the screen-grid voltage (or, for triodes, the plate voltage) for cut-off, as given in the characteristics or typical operation values. These terms are defined as follows: *sharp*, less than 10 per cent; *semiremote*, 10 or more, but less than 20 per cent, *remote*, 20 per cent or more.

For more complete data on these types, refer to the **Technical Data For RCA Receiving Tubes**.

APPLICATIONS

- | | |
|------------------------------------------------------------------------------------------------------------------------------------------------------------------------------------------------------------------------------------------------------------------------------------------------------------------------------------------------------------------------------------------------------------------------------------------------------------------------------------------------------------------------------|------------------------------------------------------------------------------------------------------------------------------------------------------------------------------------------------------------------------------------------------------------------------------------------------------------------------------------------------------------------------------------------------------------------------------------------------------------------------------------------------------------------------------|
| <ol style="list-style-type: none"> 1. Audio-Frequency Amplifiers 2. Automatic Gain Control Circuits (AGC and AVC) 3. Blankers 4. Burst Amplifiers 5. Chroma Amplifiers 6. Color Killers 7. Color Matrixing Circuits 8. Dampers 9. Demodulators (Color TV) 10. Detectors (AM) 11. Discriminators (Detectors) 12. Horizontal-Deflection 13. Intermediate-Frequency Amplifiers 14. Limiters | <ol style="list-style-type: none"> 15. Pentagrid Converters 16. Mixer-Oscillators—RF 17. Multivibrators 18. Oscillators 19. Phase Splitters 20. Radio-Frequency Amplifiers 21. Reactance Circuits 22. Rectifiers (Vacuum) 23. Regulators (High Voltage) 24. Sync Separators and Amplifiers 25. Tuning Indicators 26. Vertical-Deflection Circuits (Oscillator and Amplifier) 27. Video Amplifiers |
|------------------------------------------------------------------------------------------------------------------------------------------------------------------------------------------------------------------------------------------------------------------------------------------------------------------------------------------------------------------------------------------------------------------------------------------------------------------------------------------------------------------------------|------------------------------------------------------------------------------------------------------------------------------------------------------------------------------------------------------------------------------------------------------------------------------------------------------------------------------------------------------------------------------------------------------------------------------------------------------------------------------------------------------------------------------|

1. AUDIO-FREQUENCY AMPLIFIERS

Voltage Amplifiers

Medium-Mu Triode—Sharp-Cutoff Pentode
• 7199†

Medium-Mu Twin Triode
• 6SN7GTB • 12SN7GTA
• 12AU7A/ECC82

Twin Diode—High-Mu Triode

• 4AV6 • 6BN8 • 12AV6
• 6AT6 • 8BN8 • 14GT8
• 6AV6 • 12AT6

Triple Diode—High-Mu Triode

• 5T8 • 6T8A • 19T8

• Miniature

○ Octal

† For high-fidelity equipment

High-Mu Twin Triode

- 6EU7† • 12AX7A/ ○ 12SL7GT
- 6SL7GT ECC83† • 7025†

Sharp-Cutoff Pentode

- 6AU6A • 5879†
- 6HS6 • 7543†

*Power Amplifiers***Beam Power Tube**

- 5AQ5 ○ 6Y6GA/6Y6G • 25C5
- 6AQ5A • 11DS5 • 35C5
- 6AS5 • 12AB5 • 50C5
- 6CU5 • 12AQ5 ○ 50L6GT
- 6DS5 • 12CA5 • 6973†
- 6GC5 • 12CU5/12C5 • 7027A†
- 6L6 ○ 12V6GT ○ 7355†
- 6L6GC† ○ 12W6GT ○ 7408†
- 6V6GTA • 17CU5/17C5 ○ 7581A†
- 6W6GT

Beam Power Tube—Sharp-Cutoff Pentode

- ‡ 6AD10 ‡ 6T10* ‡ 12BF11*
- ‡ 6AL11 ‡ 12AL11 ‡ 17BF11*
- ‡ 6BF11*

Power Pentode

- 6BQ5/EL34 • 10BQ5 • 35EH5
- 6EH5 • 10GK6 • 50EH5
- 6F6 • 12FX5 • 60FX5
- 6GK6 • 16GK6 • 7189†
- 6K6GT • 19FX5 ▲ 7868†
- 8BQ5 • 25EH5 ○ 7591A

2. AUTOMATIC GAIN CONTROL CIRCUITS (AGC & AVC)**Twin Diode—High-Mu Triode**

- 4AV6 • 6AV6 • 12AV6
- 6AT6 • 12AT6

Medium-Mu Triode—Sharp-Cutoff Pentode

- 5AN8 • 6AZ8 • 6GH8A
- 5GH8A • 6BA8A • 9GH8A
- 6AN8A

High-Mu Triode—Sharp-Cutoff Pentode

- 6AW8A • 6LC8 • 8KA8
- 6HF8 • 8AW8A • 8LC8
- 6JV8 • 8JV8 • 10HF8
- 6KA8

Sharp-Cutoff Twin Pentode

- 3BU8/ • 4HS8 • 6HS8
- 3GS8 • 6BU8

Sharp-Cutoff Pentode*

- 6GY6/6GX6

Pentagrid Amplifier

- 3BY6 • 4CS6 • 6CS6
- 3CS6 • 6BY6

3. BLANKERS**Medium-Mu Triode—Sharp-Cutoff Pentode**

- 5GH8A • 6MQ8 • 9GH8A
- 6GH8A

Medium-Mu Twin Triode

- 6FQ7/6CG7 • 8FQ7/8CG7 • 12BH7A
- 6GU7 • 8GU7 • 12FQ7

Medium-Mu Triode—Semiremote-Cutoff Pentode

- 6LM8

High-Mu Triode—Sharp-Cutoff Pentode

- 6KT8

4. BURST AMPLIFIERS**Medium-Mu Triode—Sharp-Cutoff Pentode**

- 5EA8 • 6EA8 • 9GH8A
- 5GH8A • 6GH8A • 19EA8

Medium-Mu Triode—Semiremote-Cutoff Pentode

- 6LM8 • 6MU8

Twin Diode—High-Mu Triode

- 6BN8 • 8BN8

Sharp-Cutoff Pentode

- 3CB6/3CF6 • 4EW6 • 6CB6A/6CF6
- 3JC6A • 4JC6A • 6EW6
- 4CB6 • 5EW6 • 6JC6A

5. CHROMA AMPLIFIERS**Medium-Mu Triode—Sharp-Cutoff Pentode**

- 5GH8A • 6HL8 • 9GH8A
- 6GH8A • 6MQ8

High-Mu Triode—Sharp-Cutoff Pentode

- 6AW8A • 6LF8
- 6KT8 • 8AW8A

Medium-Mu Twin Triode

- 6FQ7/6CQ7 • 8FQ7/8CG7 • 12BH7A
- 6GU7 • 8GU7 • 12FQ7

6. COLOR KILLERS**Quadruple Diode**

- 6JU8A • 8JU8A

Medium-Mu Triode—Sharp-Cutoff Pentode

- 5GH8A • 6MQ8 • 9GH8A
- 6GH8A

High-Mu Triode—Sharp-Cutoff Pentode

- 6KT8

7. COLOR MATRIXING CIRCUITS

Medium-Mu Twin Triode

- 6FQ7/6CG7 • 8GU7 • 12FQ7
- 6GU7 • 12AZ7
- 8FQ7/8CG7 • 12BH7A

Medium-Mu Triode—Sharp Cutoff Pentode

- 5GH8A • 6GH8A • 9GH8A

Medium-Mu Triple Triode

- ▲ 6MD8 ‡ 6MJ8 ▲ 12MD8

High-Mu Triple Triode

- ‡ 6MN8

Twin Pentode

- 6LE8 • 10LE8 • 15LE8

Quadruple Diode

- 6JU8A • 8JU8A

Sharp-Cutoff Pentode

- 3CB6/3CF6 • 6CB6A/6CF6
- 4CB6

8. DAMPERS

Half-Wave (Diode)

- 6AU4GTA ○ 6DM4A/ ‡ 17BE3/
- 6AX4GTB 6DA4 17BZ3
- ▲ 6BA3 ▲ 6DN3 • 17BR3/
- ‡ 6BE3 ▲ 6DW4B 17RK19
- ▲ 6BS3A • 12AF3/ ▲ 17BS3A/
- ‡ 6CE3/6CD3/ 12BR3/ 17DW4A
- 6DT3 12RK19 ‡ 17BW3
- ‡ 6CG3/6BW3/ ○ 12AX4GTB • 17CT3
- 6DQ3 ▲ 12AY3A ○ 17DE4
- ▲ 6CJ3/ ‡ 12BE3 ○ 17DM4A
- 6CH3 ▲ 12BS3A/ ▲ 19DK3
- ▲ 6CL3/ 12DW4A ‡ 22BW3
- 6CK3 ▲ 12CL3 ○ 22DE4
- ▲ 6CM3 ▲ 12CM3 • 25CT3
- 6DE4/ ▲ 12DL3 ▲ 25DL3
- 6CQ4 ○ 17AX4GTA ‡ 34CE3
- ▲ 6DL3 ▲ 17AY3A

Half-Wave (Diode)—Horizontal-Deflection Amplifier

- ‡ 33GY7A ‡ 38HK7 ‡ 53HK7
- ‡ 38HE7 ‡ 50GY7A

9. DEMODULATORS (COLOR TV)

Medium-Mu Twin Triode

- 12BH7A • 12AZ7A

Medium-Mu Triode—Sharp-Cutoff Pentode

- 5GH8A • 6MQ8 • 9GH8A
- 6GH8A

High-Mu Twin Triode

- 12AZ7A

Sharp-Cutoff Pentode*

- 5HZ6 • 6GY6/6GX6 ‡ 12BV11
- ‡ 6BV11 • 6HZ6

Pentagrid Amplifier

- 6BY6

Twin Pentode

- 4MK8A • 6MK8A • 15LE8
- 6LE8 • 10LE8

Beam Deflection Tube

- 6JH8 • 6ME8

10. DETECTORS (AM)

Diode—Sharp-Cutoff Pentode

- 5AM8 • 6AM8A • 6AS8

Twin Diode

- 3AL5 • 6AL5 • 12AL5

Twin Diode—High-Mu Triode

- 4AV6 • 6BN8 • 12AT6
- 6AT6 • 6CN7 • 12AV6
- 6AV6 • 8BN8 • 14GT8

Triple Diode—High-Mu Triode

- 5T8 • 6T8A • 19T8

Quadruple Diode

- 6JU8A • 8JU8A

11. DISCRIMINATORS (DETECTORS)

FM

Twin Diode

- 3AL5 • 6AL5 • 12AL5

Twin Diode—High-Mu Triode

- 6BN8

Triple Diode—High-Mu Triode

- 5T8 • 6T8A • 19T8

Beam Tube

- 3BN6 • 4BN6 • 6BN6/
- 6KS6

Beam Power Tube—Sharp-Cutoff Pentode

- ‡ 6AD10 ‡ 6T10 ‡ 12BF11
- ‡ 6AL11 ‡ 6Z10/6J10 ‡ 13Z10/13J10
- ‡ 6BF11 ‡ 12AL11 ‡ 17BF11

FM Quadrature-Grid

Sharp-Cutoff Pentode*

- 3DT6A • 5HZ6 • 6GY6/6GX6
- 4DT6A • 6DT6A • 6HZ6

Beam Tube

- 3BN6 • 4BN6 • 6BN6/
- 6KS6

*Horizontal AFC***Twin Diode—High-Mu Triode**

- 6BN8 • 8BN8 • 8CN7
- 6CN7

Twin Diode—Medium-Mu Twin Triode

- ‡ 6B10 ‡ 8B10

Twin Diode—Sharp Cutoff Pentode

- 6LT8 • 8LT8 • 11LT8

12. HORIZONTAL-DEFLECTION*Oscillators***Medium-Mu Triode—Sharp-Cutoff Pentode**

- 5GH8A • 6GH8A • 9GH8A

Twin Diode—Medium-Mu Twin Triode

- ‡ 6B10 ‡ 8B10

Three Unit Triode

- ‡ 6U10

Medium-Mu Twin Triode

- 6FQ7/6CG7 • 12AU7A/ • 12FQ7
- 6SN7GTB • ECC82 • 12SN7GTA
- 8FQ7/8CG7 • 12BH7A

*Horizontal-Deflection Amplifiers***Beam Power Tube**

- 6AU5GT ‡ 6KN6 ▲ 22JF6
- 6AV5GA ‡ 6LB6 ▲ 22JG6A
- 6BQ6GTB/ ‡ 6LR6 ▲ 22JR6
- 6CU6 ▲ 6ME6 ▲ 22KM6
- 6CBSA ▲ 6MJ6/ ▲ 24LQ6/
- 6CD6GA 6LQ6/ 24JE6C
- 6DQ5 6JE6C • 25A V5GA
- ▲ 6GJ5A • 12AV5GA • 25BQ6GTB/
- ▲ 6GT5A • 12BQ6GTB/ 25CU6
- 6GW6/ 12CU6 • 25CD6GB
- 6DQ6B ▲ 12JB6A • 25DN6
- ▲ 6JB6A ▲ 12JT6A ‡ 31JS6C
- ▲ 6JF6 ▲ 17GJ5A ▲ 31LQ6
- ▲ 6JG6A ▲ 17GT5A ▲ 31LZ6
- ‡ 6JM6A • 17GW6/ ‡ 35LR6
- ▲ 6JR6 17DQ6B ‡ 36KD6/
- ‡ 6JS6C ▲ 17JB6A 40KD6
- ▲ 6JT6A ▲ 17JG6A ▲ 36MC6
- ▲ 6JU6 ‡ 17JM6A ‡ 38HK7
- ▲ 6KM6 ▲ 17JT6A ‡ 42KN6

13. INTERMEDIATE-FREQUENCY AMPLIFIERS**Medium-Mu Triode—Sharp-Cutoff Pentode**

- 5AN8 • 6AZ8 • 6MQ8
- 5GH8A • 6BA8A • 8AU8A
- 6AN8A • 6HL8 • 9GH8A
- 6AU8A • 6GH8A

High-Mu Triode—Sharp-Cutoff Pentode

- 6AW8A • 6KV8 • 10GN8
- 6EB8 • 6MV8 • 10HF8
- 6GN8 • 8AW8A • 10JA8/
- 6HF8 • 8GN8/ 10LZ8
- 6JV8 8EB8 • 11KV8
- 6KT8 • 8JV8

Sharp-Cutoff Pentode

- 3AU6 • 4EW6 • 6DC6
- 3BC5/ • 4JC6A • 6DE6
- 3CE5 • 4JD6 • 6DK6
- 3CB6/ • 5EW6 • 6EJ7/
- 3CF6 • 6AG5 EF184
- 3DK6 • 6AK5/ • 6EW6
- 3JC6A EF95 • 6HS6
- 3JD6 • 6AU6A • 6JC6A
- 4AU6 • 6BC5/ • 6JD6
- 4CB6 6CE5 • 12AU6
- 4DE6 • 6CB6A/ • 12DK6
- 4DK6 6CF6

Diode—Sharp-Cutoff Pentode

- 5AM8 • 6AM8A • 6AS8

Semiremote-Cutoff Pentode

- 3BZ6 • 4JH6 • 6GM6
- 3EH7/ • 4KT6 • 6HR6
- XE183 • 5GM6 • 6JH6
- 3KT6 • 6BZ6 • 6KT6
- 4BZ6 • 6EH7/ • 12BZ6
- 4EH7/ EF183 • 19HR6
- LF183

Remote-Cutoff Pentode

- 6BA6/ • 12BA6
- EF93

14. LIMITERS

- 3AU6 • 4JD6 • 6DE6
- 3BC5/3CE5 • 5EW6 • 6DK6
- 3CB6/3CF6 • 6AG5 • 6EJ7/
- 3DK6 • 6AK5/ EF184
- 3JC6A EF95 • 6EW6
- 4AU6 • 6AU6A • 6HS6
- 4CB6 • 6BC5/ • 6JC6A
- 4DE6 6CE5 • 6JD6
- 4DK6 • 6CB6A/ • 12AU6
- 4EW6 6CF6 • 12DK6
- 4JC6A • 6DC6

15. PENTAGRID CONVERTERS

- 6BA7 • 6BE6 • 12BE6

16. MIXER-OSCILLATORS—RF**Medium-Mu Triode—Sharp-Cutoff Tetrode**

- 5CL8A • 6CL8A • 19JN8/
- 6CQ8 • 6CQ8 19CL8A

• Miniature

○ Octal

▲ Novar

‡ Duodecar

* Dual-control grids

Medium-Mu Triode—Sharp-Cutoff Pentode

- 4KE8 • 5U8 • 6KZ8
- 5AT8 • 5X8 • 6U8A/
- 5B8 • 6AT8A 6KD8
- 5BR8/ • 6BR8A/ • 6X8A
- 5FV8 • 6FV8A • 9KZ8
- 5CG8 • 6EA8 • 9U8A
- 5EA8 • 6FG7 • 19EA8
- 5FG7 • 6HB7 • 19X8
- 5KE8 • 6KE8

High-Mu Twin Triode

- 6DT8 • 12AT7/ • 12DT8
- ECC81

17. MULTIVIBRATORS**Medium-Mu Triode—Sharp-Cutoff Pentode**

- 5GH8A • 6GH8A • 9GH8A

Medium-Mu Twin Triode

- 5J6 • 8FQ7/8CG7 • 12BH7A
- 6FQ7/6CG7 • 8GU7 ◊ 12SN7-
- 6GU7 • 9AU7 GTA
- 6J6A • 12AU7A/ • 12FQ7
- ◊ 6SN7GTB ECC82 • 19J6
- 7AU7

High-Mu Twin Triode

- 12AX7A/ ECC83

18. OSCILLATORS*Radio Frequency—UHF***Medium-Mu Triode**

- 2AF4B/ • 3AF4A/ ◊ 6DV4
- 2DZ4 3DZ4 6DZ4
- ◊ 2DV4 • 6AF4A/
- 6DZ4

*Radio Frequency—VHF***Medium-Mu Twin Triode**

- 5J6 • 6J6A • 19J6

High-Mu Triode

- 6AB4

Power Triode

- 6C4 (Class C)

*3.58-MHz (Color TV)***Medium-Mu Triode—Sharp-Cutoff Pentode**

- 5GH8A • 6GH8A • 9GH8A

High-Mu Triode—Sharp-Cutoff Pentode

- 6KT8

19. PHASE SPLITTERS**Medium-Mu Twin Triode**

- 6FQ7/6CG7 • 8FQ7/8CG7 • 12BH7A
- 6GU7 • 8GU7 • 12FQ7
- ◊ 6SN7GTB • 9AU7 ◊ 12SN7-
- 7AU7 • 12AU7A/ GTA
- ECC82

High-Mu Triode—Sharp-Cutoff Pentode

- 6AW8A • 8AW8A • 10GN8
- 6EB8 • 8GN8/ • 10HF8
- 6GN8 8EB8 • 10JA8/
- 6HF8 10LZ8

High-Mu Twin Triode

- ◊ 6SL7GT • 12AX7A/ ◊ 12SL7GT
- ECC83 • 70Z5

Medium-Mu Triode—Sharp-Cutoff Pentode

- 5EA8 • 6GH8A • 7199†
- 5GH8A • 9GH8A • 19EA8
- 6EA8

20. RADIO-FREQUENCY AMPLIFIERS**Medium-Mu Triode**

- 2BN4A • 6BC4 • 6BN4A
- 3BN4A

Medium-Mu Triode—Sharp-Cutoff Tetrode

- 6CQ8

Medium-Mu Twin Triode

- 4BC8 • 5BQ7A • 6HQ7A/
- 4BQ7A/ • 6BC8/ 6BZ7/
- 4BZ7 6BZ8 6BS8
- 5BK7A • 6BK7B

High-Mu Triode

- △ 2CW4 • 3FH5 △ 6DS4
- △ 2DS4 • 3GK5 • 6ER5
- △ 2EG4 • 3HM5/3HA5 • 6FH5
- 2FH5 • 3HQ5 • 6GK5/
- 2GK5/ • 4GK5 6FQ5A
- 2FQ5A • 4HM5/ • 6HM5/6HA5
- 2HM5/ 4HA5 • 6HQ5
- 2HA5 • 4HQ5 △ 13CW4
- 2HQ5 • 6AB4
- 3ER5 △ 6CW4

High-Mu Twin Triode

- 6DT8 • 12DT8

Power Triode

- 6C4 (Class C)

Sharp-Cutoff Tetrode

- 2CY5 • 3CY5 • 6CY5

Sharp-Cutoff Pentode

- 3AU6 • 6AG5 • 6CB6A/
- 3CB6/ • 6AK5/ 6CF6
- 3BC5/3CE5 EF95 • 6DC6
- 3CF6 • 6AU6A • 6DE6
- 4AU6 • 6BC5/ • 12AU6
- 4CB6 6CE5
- ◊ 4DE6 • 6BH6

Remote-Cutoff Pentode

- 6BA6/ • 6BJ6 • 12BA6
- EF93

21. REACTANCE CIRCUITS

Medium-Mu Triode—Sharp-Cutoff Pentode

- 5AN8 • 6AZ8 • 6GH8A
- 5GH8A • 6BA8A • 9GH8A
- 6AN8A

Twin Diodes—High-Mu Triode

- 6CN7 • 8CN7

High-Mu Triode—Sharp-Cutoff Pentode

- 6AW8A • 8AW8A

22. RECTIFIERS (VACUUM)

Power-Supply Types

Half-Wave (Diode)

- 35W4 ⊙ 35Z5GT

Full-Wave (Twin Diode)

- ⊙ 3DG4 ⊙ 5V4GA • 6X4
- ⊙ 5AS4A ⊙ 5Y3GT ⊙ 6X5GT
- ▲ 5BC3A • 6CA4 • 12X4
- ⊙ 5U4GB

High-Voltage Types

Half-Wave (Diode)

- 1AY2A ‡ 2BU2/ ⊙ 3CN3B
- ⊙ 1G3GTA/ 2AH2 ⊙ 3CU3A
- 1B3GT • 3A2 ⊙ 3CZ3A
- ⊙ 1K3A/ ⊙ 3A3C ⊙ 3DA3/
- 1J3 ‡ 3AT2B 3DH3
- 1V2 ‡ 3AW2A ⊙ 3DB3/
- 1X2C ‡ 3BN2A 3CY3
- ‡ 2AS2A ‡ 3BW2/ ⊙ 3DC3
- 2AV2 3BS2A/ ⊙ 3DJ3
- 3BT2

23. REGULATORS
(HIGH VOLTAGE)

Beam Triode—Shunt Type

- ⊙ 6BK4C/ ⊙ 6LJ6A/ • 6MA6
- 6EL4A 6LH6A
- ⊙ 6EN4

Beam Power Tube—Pulse Type

- ‡ 6HS5 ▲ 17KV6A ▲ 22KV6A
- ▲ 6KV6A

24. SYNC SEPARATORS
AND AMPLIFIERS

High-Mu Twin Triode

- 12BZ7

Medium-Mu Triode—Sharp-Cutoff Tetrode

- 6CQ8

Sharp-Cutoff Twin Pentode

- 3BU8/ • 4HS8 • 6HS8
- 3GS8 • 6BU8

Pentagrid Amplifier

- 3BY6 • 4CS6 • 6CS6
- 3CS6 • 6BY6

High-Mu Triode—Sharp-Cutoff Pentode

- 6KT8 • 6MV8

Medium-Mu Triode—Sharp-Cutoff Pentode
(Video Output)

- 6CX8 • 8CX8 • 11LQ8
- 6LQ8

Medium-Mu Triode—Sharp-Cutoff Pentode

- 5AN8 • 6AZ8 • 6HL8
- 5GH8A • 6BA8A • 6MQ8
- 6AN8A • 6CU8 • 8AU8
- 6AU8A • 6GH8A • 9GH8A

Medium-Mu Twin Triode

- 6FQ7/6CG7 • 12AU7A/ • 12FQ7
- 8FQ7/8CG7 ECC82

Twin Diode—High-Mu Triode

- 6CN7 • 8CN7

High-Mu Triode—Sharp-Cutoff Pentode
(Video Output)

- 6AW8A • 6KT8 • 8KA8
- 6EB8 • 6KV8 • 8LC8
- 6GN8 • 6LC8 • 10GN8
- 6GW8/ • 8AW8A • 10HF8
- ECL86 • 8GN8/ • 10JA8/
- 6HF8 • 8EB8 10LZ8
- 6JV8 • 8JV8 • 11KV8
- 6KA8

25. TUNING INDICATORS

Indicator with Triode Unit

- 6E5 6U5

Twin Indicator Units

- ⊙ 6AF6G

26. VERTICAL-DEFLECTION
CIRCUITS*Oscillators and Amplifiers (Combined)*

Medium-Mu Triode—Low-Mu Triode

- 6DE7 • 10EW7 • 13DE7
- 6EW7 • 10DE7

Medium-Mu Dual Triode

- 6CM7 • 8CM7 • 8CS7
- 6CS7

Medium-Mu Twin Triode

- 6FQ7/6CG7 • 8FQ7/8CG7 • 12FQ7

• Miniature

⊙ Octal

▲ Novar

‡ Duodecar

High-Mu Triode—Low-Mu Triode

- | | | |
|---------|----------|----------|
| • 6CY7 | • 10DR7 | ⊙ 13FM7/ |
| • 6DR7 | ⊙ 10EM7 | 15FM7 |
| ⊙ 6EM7/ | ▲ 10GF7A | ▲ 13FD7 |
| 6EA7 | ▲ 13DR7 | ▲ 13GF7A |
| ▲ 6FD7 | ⊙ 13EM7/ | |
| ▲ 6GF7A | 15EA7 | |

High-Mu Triode—Beam Power Tube

- | | | |
|---------|----------|---------|
| ▲ 6KY8A | ‡ 6LU8 | ‡ 16LU8 |
| ▲ 6LR8 | ▲ 15KY8A | ▲ 21LR8 |
| | | ‡ 21LU8 |
| | | ▲ 31LR8 |

Dual Triode

- | | | |
|---------|---------|----------|
| ⊙ 6EM7/ | ▲ 6GF7A | ⊙ 13EM7/ |
| 6EA7 | | 15EA7 |

Dual Triode—Beam Power Tube

- ‡ 23Z9

Medium-Mu Triode—Power Pentode

- | | | |
|---------|---------|---------|
| ‡ 6JZ8 | ‡ 17JZ8 | ‡ 25JZ8 |
| ‡ 13JZ8 | ‡ 24JZ8 | |

Amplifiers

Low-Mu Triode

- 12B4A

Medium-Mu Triode

- 6S4A

Beam Power Tube

- | | | |
|---------|----------|----------|
| • 5AQ5 | ‡ 6JB5/ | • 11DS5 |
| • 5CZ5 | 6HE5 | • 12AQ5 |
| • 6AQ5A | • 6JQ6# | • 12JQ6# |
| • 6CZ5 | ⊙ 6V6 | ⊙ 12V6GT |
| • 6DS5 | ⊙ 6V6GTA | • 17JQ6# |
| • 6EM5 | • 8EM5 | |
| ‡ 6JA5 | ‡ 10JA5 | |

Power Pentode

- | | | |
|---------|---------|---------|
| • 6GK6 | • 10GK6 | • 16GK6 |
| ⊙ 6K6GT | | |

27. VIDEO AMPLIFIERS

Medium-Mu Triode—Sharp-Cutoff Pentode

- | | | |
|---------|---------|---------|
| • 5AN8 | • 6AZ8 | • 6MQ8 |
| • 5GH8A | • 6BA8A | • 8AU8 |
| • 6AN8A | • 6GH8A | • 9GH8A |
| • 6AU8A | • 6HL8 | |

Medium-Mu Triode—Sharp-Cutoff Pentode

(Video Output)

- | | | |
|--------|--------|---------|
| • 6CX8 | • 8CX8 | • 11LQ8 |
| • 6LQ8 | | |

High-Mu Triode—Sharp Cutoff Pentode

(Video Output)

- | | | |
|---------|---------|----------|
| • 6AW8A | • 6LF8 | • 10GN8 |
| • 6EB8 | • 8AW8A | • 10HF8 |
| • 6GN8 | • 8GN8/ | • 10JA8/ |
| • 6HF8 | 8EB8 | 10LZ8 |
| • 6JV8 | • 8JV8 | • 10LY8 |
| • 6KV8 | | • 11KV8 |

Sharp-Cutoff Pentode (Video Output)

- | | | |
|--------|-----------|----------|
| • 6AG7 | • 10GK6 | • 12HG7 |
| • 6CL6 | • 11HM7 | • 12HG7/ |
| • 6GK6 | • 12BY7A/ | 12GN7A |
| • 6JG5 | 12BV7/ | • 12HL7 |
| • 7KY6 | 12DQ7 | |

Diode—Sharp-Cutoff Pentode

- | | | |
|--------|---------|--------|
| • 5AM8 | • 6AM8A | • 6AS8 |
|--------|---------|--------|

High-Mu Triode—Sharp-Cutoff Pentode

- 6KT8

Sharp-Cutoff Pentode

- | | | |
|---------|---------|---------|
| • 3JC6A | • 4JC6A | • 6JC6A |
|---------|---------|---------|

Technical Data for RCA

Receiving Tubes

Entertainment and Industrial Types

This section contains technical data for RCA receiving tubes, intended for use in many diverse entertainment and industrial applications such as standard broadcast, FM, television receiver, audio amplifier, on-off control, voltage regulator, and voltage reference. Detailed data are presented on popular types. Essential information on less active types and on discontinued types in which there still may be some interest is given in chart form at the end of the section.

Tube types are listed in this section according to the numerical-alphabetical-numerical sequence of their type designations. Tube types which have superseding versions are cross-referenced to active types. In addition, an alpha-numeric listing of foreign type designations is included at the end of this data section.

A grid-No. 2 input rating chart for certain voltage-amplifier types, as specified in the technical data, is shown on page 300. **Safety Precautions** are given on page 93. Characteristics for RCA television picture tubes for replacement use are given in **RCA Picture Tube Characteristics Charts**.

When choosing types for the design of new electronic equipment, the designer should refer to the **Application Guide for RCA Receiving Tubes** which starts on page 104.

To expedite the preliminary search for interchangeable tube types, the section **Terminal Diagrams**, which starts on page 594, includes a comprehensive listing of domestic and foreign tube types having the same basing arrangement. The **Key To Terminal Diagrams** is given on page 612.

Two replacement guides are also included. A **Replacement Guide—Entertainment Receiving Types** and a **Replacement Guide—Industrial Receiving Types** are given on pages 650 and 657 respectively.

OA2INDUSTRIAL
TYPE**VOLTAGE REGULATOR**

Miniature type cold-cathode, glow-discharge tube used in voltage regulator applications. Outlines section, 5D; requires miniature 7-contact socket.

MAXIMUM RATINGS (Absolute-Maximum Values)

Average Starting Current♦	75	mA
DC Cathode Current	30	mA
Frequency	5 min	mA
Ambient-Temperature Range	0	Hz
	-55 to +90	°C

MAXIMUM CIRCUIT VALUES

Shunt Capacitor	0.1	μF
Series Resistor	See Operating Considerations	

CHARACTERISTICS RANGE VALUES FOR EQUIPMENT DESIGN

	Min.	Av.	Max.	
DC Anode-Supply Voltage	185 [■]	—	—	volts
Anode Breakdown Voltage	—	156	185*	volts
Anode Voltage Drop	140 [●]	151	168*	volts
Regulation (5 to 30 mA)	—	2	6*	volts

♦ Averaged over starting period not exceeding 10 seconds. This starting period must be followed by a steady-state operating condition of at least 20 minutes, or tube performance will be impaired.

■ Not less than indicated supply voltage should be provided to insure "starting" throughout tube life.

* Maximum individual tube value during useful life.

● Minimum individual tube value during useful life.

Operating Considerations

Sufficient resistance must always be used in series with the tube to limit the current through the tube. The value for the series resistor is dependent on the maximum anode-supply voltage and the ratio of the current through the load to the operating current of the tube, and should be chosen to limit the operating current through the tube to the maximum rated value at all times after the starting period.

The maximum load current that can be regulated by the tube is determined by the minimum and maximum values of the supply voltage. After the value of series resistor for the maximum supply voltage has been calculated as indicated above, it is then in order to determine if this value will permit adequate starting voltage when the supply voltage falls to its minimum value. If adequate starting voltage is not obtained, a new load current of lower value must be used and the calculations repeated. It will be apparent from such calculations that the higher the minimum supply voltage and the smaller the difference between its minimum and maximum values, the higher will be the load current that can be regulated.

When equipment utilizing the tube is "turned on", a starting current in excess of the average operating current is permissible as indicated under Maximum Ratings. When the tube is subjected to such high starting currents, the regulated voltage may require up to 20 minutes to drop to its normal operating value. This performance is characteristic of voltage-regulator tubes of the glow-discharge type. Similarly, the regulation is affected by changes in current within the operating current range.

In order to handle more load current, two or more tubes may be operated in parallel, but such parallel operation requires that a resistance of approximately 100 ohms be used in series with each tube in order to equalize division of the current between the paralleled tubes. The disadvantage of this method, of course, is that the use of resistors impairs the regulation which can be obtained.

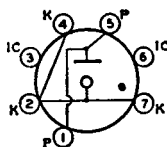

5B0

If the associated circuit has a capacitor in shunt with the tube, the capacitor should be limited in value to 0.1 μ F. A larger value may cause the tube to oscillate and thus give unstable regulation performance.

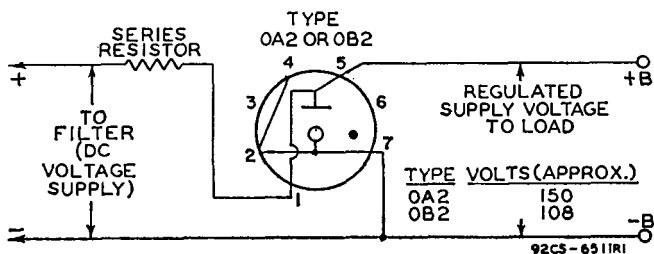

Typical circuit to provide regulated supply voltage of approximately 150 or 108 volts to load. Removal of tube from socket removes voltage from load.

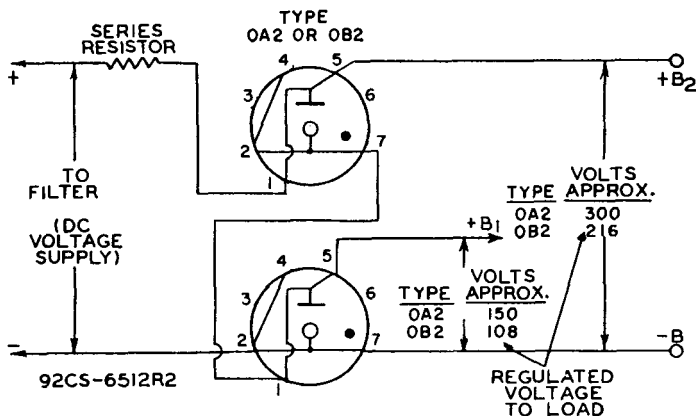

Typical circuit using two OA2's or two OB2's to provide regulated supply voltages of approximately 300 or 216 volts and 150 or 108 volts to load. Socket connections are so made that voltage on load is removed when either tube is taken from its socket.

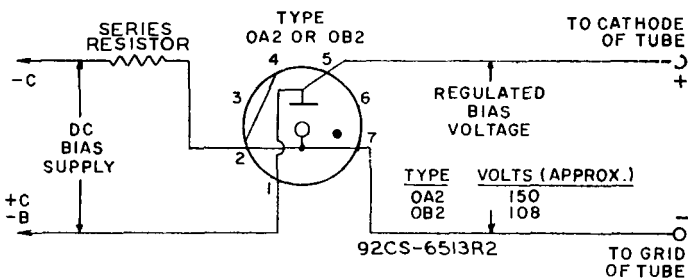

Typical circuit for bias-supply regulation. Removal of tube from socket opens B-supply circuit of regulated tubes.

OA2WA
OA3
OA3A
OA4G

Refer to chart at end of section.
Refer to chart at end of section.
Refer to chart at end of section.
Refer to chart at end of section.

OB2
INDUSTRIAL
TYPE

VOLTAGE REGULATOR

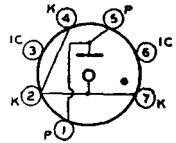

5B0

Miniature type cold-cathode, glow-discharge tube used in voltage regulator applications. Outlines section, 5D; requires miniature 7-contact socket.

MAXIMUM RATINGS (Absolute-Maximum Values)

Average Starting Current♦	75	mA
DC Cathode Current	30	mA
	5 min.	mA
Frequency	0	Hz
Ambient-Temperature Range	-55 to +90	°C

MAXIMUM CIRCUIT VALUES

Shunt Capacitor	0.1	μF
Series Resistor	See Operating Considerations	

CHARACTERISTICS RANGE VALUES FOR EQUIPMENT DESIGN

	Min.	Av.	Max.	
DC Anode-Supply Voltage	133■	—	—	volts
Anode Breakdown Voltage	—	115	133*	volts
Anode Voltage Drop	101●	108	114*	volts
Regulation (5 to 30 mA)	—	1	4*	volts

♦ Averaged over starting period not exceeding 10 seconds. This starting period must be followed by a steady-state operating condition of at least 20 minutes, or tube performance will be impaired.

■ Not less than indicated supply voltage should be provided to insure "starting" throughout tube life.

* Maximum individual tube value during useful life.

● Minimum individual tube value during useful life.

Operating Considerations

Refer to type OA2.

OB2WA
OC2

Refer to chart at end of section.

Refer to chart at end of section.

OC3
INDUSTRIAL
TYPE

VOLTAGE REGULATOR

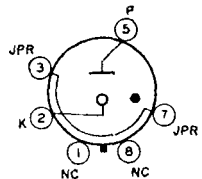

4AJ

Glass octal type cold-cathode, glow-discharge tube used in voltage regulator applications. Outlines section, 22; requires octal socket.

MAXIMUM RATINGS (Absolute-Maximum Values)

Average Starting Current♦	100	mA
DC Cathode Current	40	mA
	5 min.	mA
Frequency	0	Hz
Ambient-Temperature Range	-55 to +90	°C

MAXIMUM CIRCUIT VALUES

Shunt Capacitor	0.1	μF
Series Resistor	See Operating Considerations	

CHARACTERISTICS RANGE VALUES FOR EQUIPMENT DESIGN

	Min.	Av.	Max.	
DC Anode-Supply Voltage	133 [■]	—	—	volts
Anode Breakdown Voltage	—	115	133*	volts
Anode Voltage Drop	103 [●]	108	116*	volts
Regulation (5 to 40 mA)	—	2	4*	volts

♦ Averaged over starting period not exceeding 10 seconds. This starting period must be followed by a steady-state operating condition of at least 20 minutes, or tube performance will be impaired.

■ Not less than indicated supply voltage should be provided to insure "starting" throughout tube life.

* Maximum individual tube value during useful life.

● Minimum individual tube value during useful life.

Operating Considerations

Refer to type OA2. For circuit diagrams refer to next page.

Refer to chart at end of section.

OC3A

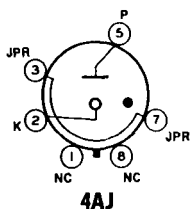

VOLTAGE REGULATOR

OD3
INDUSTRIAL
TYPE

Glass octal type cold-cathode, glow-discharge tube used in voltage regulator applications. Outlines section, 22; requires octal socket.

MAXIMUM RATINGS (Absolute-Maximum Values)

Average Starting Current ♦	100	mA
DC Cathode Current	{ 40	mA
Frequency	0	Hz
Ambient-Temperature Range	—55 to +90	°C

MAXIMUM CIRCUIT VALUES

Shunt Capacitor	0.1	μF
Series Resistor	See Operating Considerations	

CHARACTERISTICS RANGE VALUES FOR EQUIPMENT DESIGN

	Min.	Av.	Max.	
DC Anode-Supply Voltage	185 [■]	—	—	volts
Anode Breakdown Voltage	—	160	185*	volts
Anode Voltage Drop	142 [●]	153	165*	volts
Regulation (5 to 40 mA)	—	4	5.5*	volts

♦ Averaged over starting period not exceeding 10 seconds. This starting period must be followed by a steady-state operating condition of at least 20 minutes, or tube performance will be impaired.

■ Not less than indicated supply voltage should be provided to insure "starting" throughout tube life.

* Maximum individual tube value during useful life.

● Minimum individual tube value during useful life.

Operating Considerations

Refer to type OA2. For circuit diagrams refer to next page.

Refer to chart at end of section.

OD3A

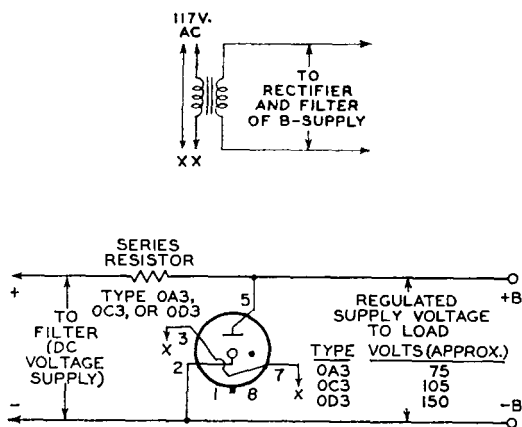

92CS-19183

Typical circuit to provide regulated supply voltage of approximately 75, 105, or 150 volts to load. Removal of tube from socket removes voltage from load.

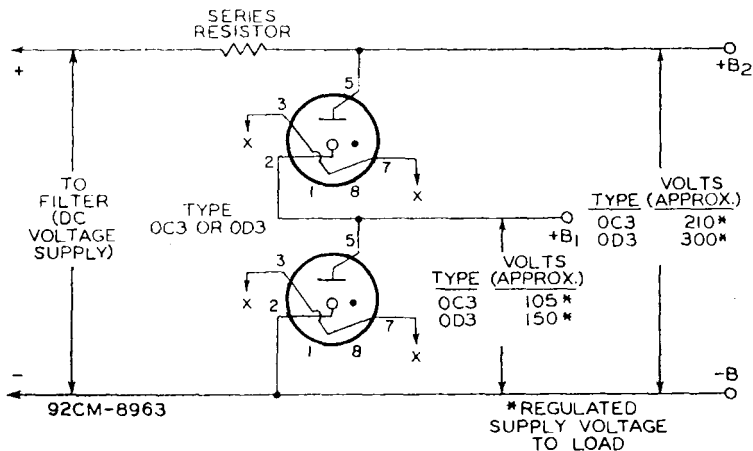

Typical circuit using two OC3's, or two OD3's to provide regulated supply voltages of approximately 210 or 300 volts and 105 or 150 volts to load. Socket connections are so made that voltage on load is removed when either tube is taken from its socket.

Refer to chart at end of data section.

OZ4

Refer to type OZ4A/OZ4.

OZ4A

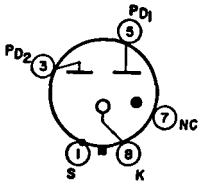

4R

FULL-WAVE GAS RECTIFIER **OZ4A/OZ4**

Metal type used as a power rectifier in equipment with vibrator-type power supplies. Outlines section, 2A; requires octal socket. This tube, like other power-handling tubes, should be adequately ventilated.

Full-Wave Rectifier

MAXIMUM AND MINIMUM RATINGS (Design-Center Values)

Peak Inverse Plate Voltage (Per Plate)	880 max	volts
Peak Starting-Supply Voltage (Per Plate)	300 [▲] min	volts
Peak Plate Current (Per Plate)	330 max	mA
DC Output Current	{ 110 max	mA
	{ 30 [▲] min	mA

TYPICAL OPERATION WITH VIBRATOR-TYPE POWER SUPPLY AND CAPACITOR INPUT TO FILTER

Peak Plate Supply Voltage (Per Plate)†	440	volts
Filter-Input Capacitor	8	μF
Total Effective Plate Supply Impedance (Per Plate)	600	ohms
DC Output at Input to Filter	310	volts
DC Output Current	100	mA

CHARACTERISTICS

Tube Voltage Drop for current of 110 mA (Per Plate)	24	volts
-----------------------------------------------------------	----	-------

MINIMUM CIRCUIT VALUE

Total Effective Plate-Supply Impedance (Per Plate)	300	ohms
----------------------------------------------------------	-----	------

[▲] Absolute value. Under no circumstances should the tube be operated below the value shown.

† Open-circuit voltage (flat portion of transformer voltage wave).

- Refer to chart at end of section. **OZ4G**
- Refer to chart at end of section. **1A3**
- Refer to chart at end of section. **1A4P**
- Refer to chart at end of section. **1A5GT**
- Refer to chart at end of section. **1A6**
- Refer to chart at end of section. **1A7GT**
- Refer to chart at end of section. **1AC5**
- Refer to chart at end of section. **1AD2**

HALF-WAVE VACUUM RECTIFIER

1AD2A

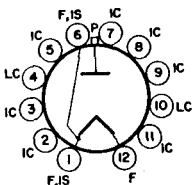

12GV

Duodecar type used as a rectifier in high-voltage pulse circuits of color and black-and-white television receivers. Outlines section, 9A; requires duodecar 12-contact socket. Socket terminals 4 and 10 may be used as tie points for components at or near filament potential. For high-voltage and X-ray safety considerations, refer to page 93.

Filament Voltage (ac/dc)	1.25	volts
Filament Current	0.2	ampere
Direct Interelectrode Capacitance (Approx.):		
Plate to Filament	1.6	pF

Pulsed Rectifier

For operation in a 525-line, 30-frame system

MAXIMUM RATINGS (Design-Maximum Values)

Peak Inverse Plate Voltage#	26000*	volts
Peak Plate Current	50	mA
Average Plate Current	0.5	mA
Filament Voltage:		
Absolute-maximum value	1.45	volts
Absolute-minimum value	1.05	volts

CHARACTERISTIC, Instantaneous Value

Tube Voltage Drop for plate current of 7 mA	225	volts
---------------------------------------------	-----	-------

X-RADIATION CHARACTERISTIC

X-Radiation, Maximum:

Statistical value controlled on a lot sampling basis	0.5	mR/hr
------------------------------------------------------	-----	-------

Pulse duration must not exceed 15% of a horizontal scanning cycle (10 microseconds).

* The dc component must not exceed 22000 volts.

Caution—Operation of this tube outside of the maximum values indicated above may result in either temporary or permanent changes in the X-radiation characteristic of the tube. Equipment design must be such that these maximum values are not exceeded.

1AD5

Refer to chart at end of section.

1AX2

Refer to chart at end of section.

1AY2

Refer to chart at end of section.

1AY2A

HALF-WAVE VACUUM RECTIFIER

Miniature type used to supply high voltage to the anode of the picture tube in television receivers. Outlines section, 33A; requires 2-contact socket. For high-voltage and X-ray safety considerations, refer to page 93.

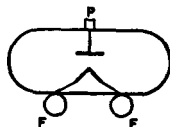

Filament Voltage (ac/dc)	1.25	volts
Filament Current	0.2	ampere
Direct Interelectrode Capacitances:		
Plate to Filament	1.4	pF

Flyback Rectifier

For operation in a 525-line, 30-frame system

MAXIMUM RATINGS (Design-Maximum Values)

Peak Inverse Plate Voltage#	26000*	volts
Peak Plate Current	50	mA
Average Plate Current	0.5	mA
Filament Voltage:		
Absolute-maximum value	1.45	volts
Absolute-minimum value	1.05	volts

CHARACTERISTIC, Instantaneous Value

Tube Voltage Drop for plate current of 7 mA	100	volts
---------------------------------------------	-----	-------

X-RADIATION CHARACTERISTIC

X-Radiation Maximum:

Statistical value controlled on a lot sampling basis	0.5	mR/hr
------------------------------------------------------	-----	-------

Pulse duration must not exceed 15% of a horizontal scanning cycle (10 microseconds).

* The dc component must not exceed 22000 volts.

Caution—Operation of this tube outside of the maximum values indicated above may result in either temporary or permanent changes in the X-radiation characteristic of the tube. Equipment design must be such that these maximum values are not exceeded.

1B3GT

Refer to chart at end of section.

For replacement use type 1G3GTA/1B3GT.

Refer to chart at end of section.
 Refer to chart at end of section.
 Refer to chart at end of section.
 Refer to chart at end of section.

1B4P
1B5/25S
1B7GT
1BC2

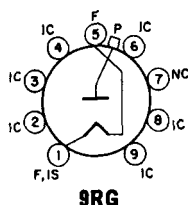

**HALF-WAVE
 VACUUM RECTIFIER**

1BC2A

Miniature type used as a high-voltage rectifier to supply power to the anode of the television picture tube. Outlines section, 7E. For high-voltage and X-ray safety considerations, refer to page 93. Heater: volts (ac/dc), 1.25; amperes, 0.2.

Flyback Rectifier

For operation in a 525-line, 30-frame system

MAXIMUM RATINGS (Design-Maximum Values)

Peak Inverse Plate Voltage#	18000 [▲]	volts
Peak Plate Current	45	mA
Average Plate Current	0.5	mA
Filament Voltage:		
Absolute-maximum value	1.45	volts
Absolute-minimum value	1.05	volts

CHARACTERISTIC, Instantaneous Value

Tube Voltage Drop for plate current of 7 mA	80	volts
---------------------------------------------	----	-------

X-RADIATION CHARACTERISTIC

X-Radiation, Maximum:

Statistical value controlled on a lot sampling basis	0.5	mR/hr
------------------------------------------------------	-----	-------

Pulse duration must not exceed 15% of a horizontal scanning cycle (10 microseconds).

▲ The dc component must not exceed 15000 volts.

Caution—Operation of this tube outside of the maximum values indicated above may result in either temporary or permanent changes in the X-radiation characteristic of the tube. Equipment design must be such that these maximum values are not exceeded.

Refer to chart at end of section.
 Refer to chart at end of section.
 Refer to chart at end of section.
 Refer to chart at end of section.
 Refer to chart at end of section.
 Refer to chart at end of section.
 Refer to chart at end of section.
 Refer to chart at end of section.
 Refer to chart at end of section.
 Refer to chart at end of section.

1BH2
1BH2A
1C5GT
1C6
1C7G
1C21
1D5GP
1D5GT
1D7G
1D8GT
1DG3

1DG3A**HALF-WAVE
VACUUM RECTIFIER**

Glass octal type used as a high-voltage rectifier to supply power to the television picture tube. Outlines section, 14J; requires octal socket. Socket terminals 1 and 7 may be used as tie points for components at or near filament potential. For high-voltage and X-ray safety considerations, refer to page 93. Filament: volts (ac/dc), 1.25; ampere, 0.2.

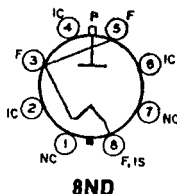
**Flyback Rectifier**

For operation in a 525-line, 30-frame system

MAXIMUM RATINGS (Design-Maximum Values)

Peak Inverse Plate Voltage#	26000●	volts
Peak Plate Current	50	mA
Average Plate Current	0.5	mA
Filament Voltage:		
Absolute-maximum value	1.45	volts
Absolute-minimum value	1.05	volts

CHARACTERISTIC, Instantaneous Value

Tube Voltage Drop for plate current of 7 mA	225	volts
---------------------------------------------	-----	-------

X-RADIATION CHARACTERISTIC**X-Radiation, Maximum:**

Statistical value controlled on a lot sampling basis	0.5	mR/hr
------------------------------------------------------	-----	-------

Pulse duration must not exceed 15% of a horizontal scanning cycle.

● The dc component must not exceed 22000 volts.

Caution—Operation of this tube outside of the maximum values indicated above may result in either temporary or permanent changes in the X-radiation characteristic of the tube. Equipment design must be such that these maximum values are not exceeded.

1DN5

Refer to chart at end of section.

1E5GP

Refer to chart at end of section.

1E7GT

Refer to chart at end of section.

1E8

Refer to chart at end of section.

1F4

Refer to chart at end of section.

1F5G

Refer to chart at end of section.

1F6

Refer to chart at end of section.

1F7G

Refer to chart at end of section.

**1G3GT/
1B3GT**

Refer to chart at end of section.

For replacement use type 1G3GTA/1B3GT.

1G3GTA

For replacement use type 1G3GTA/1B3GT.

**1G3GTA/
1B3GT****HALF-WAVE
VACUUM RECTIFIER**

Glass octal type used as a high-voltage rectifier to supply power to the anode of the television picture tube. Outlines section, 14B; requires octal socket. Socket terminals 4 and 6 may be used as tie points for components at or near filament potential. For high-voltage and X-ray safety considerations, refer to page 93. Filament: volts (ac/dc), 1.25; ampere, 0.2.

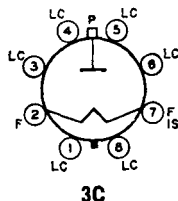

Flyback Rectifier

For operation in a 525-line, 30-frame system

MAXIMUM RATINGS (Design-Maximum Values)

Peak Inverse Plate Voltage#	26000*	volts
Peak Plate Current	50	mA
Average Plate Current	0.5	mA
Filament Voltage:		
Absolute-maximum value	1.45	volts
Absolute-minimum value	1.05	volts

CHARACTERISTIC, Instantaneous Value

Tube Voltage Drop for plate current of 7 mA	100	volts
---------------------------------------------	-----	-------

X-RADIATION CHARACTERISTIC

X-Radiation, Maximum:

Statistical value controlled on a lot sampling basis	0.5	mR/hr
------------------------------------------------------	-----	-------

Pulse duration must not exceed 15% of a horizontal scanning cycle (10 microseconds).

* The dc component must not exceed 21000 volts.

Caution—Operation of this tube outside of the maximum values indicated above may result in either temporary or permanent changes in the X-radiation characteristic of the tube. Equipment design must be such that these maximum values are not exceeded.

- | | |
|-----------------------------------|----------------|
| Refer to chart at end of section. | 1G4GT |
| Refer to chart at end of section. | 1G5G |
| Refer to chart at end of section. | 1G6GT |
| Refer to chart at end of section. | 1H4G |
| Refer to chart at end of section. | 1H5GT |
| Refer to chart at end of section. | 1H6G |
| Refer to chart at end of section. | 1J3 |
| Refer to chart at end of section. | 1J5G |
| Refer to chart at end of section. | 1J6G |
| | 1J6GT |
| | 1K3 |
| Refer to chart at end of section. | 1K3/1J3 |

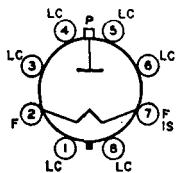

3C

HALF-WAVE VACUUM RECTIFIER 1K3A/1J3

Glass octal type used as a high-voltage rectifier to supply power to the anode of the television picture tube. Outlines section, 14B; requires octal socket. Socket terminals 4 and 6 may be used as tie points for components at or near filament potential. For high-voltage and X-ray safety considerations, refer to page 93.

Filament: volts (ac/dc), 1.25; ampere, 0.2.

Flyback Rectifier

For operation in a 525-line, 30-frame system

MAXIMUM RATINGS (Design-Maximum Values)

Peak Inverse Plate Voltage#	26000*	volts
Peak Plate Current	50	mA
Average Plate Current	0.5	mA
Filament Voltage:		
Absolute-maximum value	1.45	volts
Absolute-minimum value	1.05	volts

CHARACTERISTIC, Instantaneous Value

Tube Voltage Drop for plate current of 7 mA 225 volts

X-RADIATION CHARACTERISTIC**X-Radiation, Maximum:**

Statistical value controlled on a lot sampling basis 0.5 mR/hr

Pulse duration must not exceed 15% of a horizontal scanning cycle (10 microseconds).

* The dc component must not exceed 22000 volts.

Caution—Operation of this tube outside of the maximum values indicated above may result in either temporary or permanent changes in the X-radiation characteristic of the tube. Equipment design must be such that these maximum values are not exceeded.

1L4	Refer to chart at end of section.
1L6	Refer to chart at end of section.
1LA4	Refer to chart at end of section.
1LA6	Refer to chart at end of section.
1LB4	Refer to chart at end of section.
1LC5	Refer to chart at end of section.
1LC6	Refer to chart at end of section.
1LD5	Refer to chart at end of section.
1LE3	Refer to chart at end of section.
1LG5	Refer to chart at end of section.
1LH4	Refer to chart at end of section.
1LN5	Refer to chart at end of section.
1N2A	Refer to chart at end of section.
1N5GT	Refer to chart at end of section.
1N6G	Refer to chart at end of section.
1P5GT	Refer to chart at end of section.
1Q5GT	Refer to chart at end of section.
1R5	Refer to chart at end of section.
1S2A/DY87	Refer to chart at end of section.
1S4	Refer to chart at end of section.
1S5	Refer to chart at end of section.
1T4	Refer to chart at end of section.
1T5GT	Refer to chart at end of section.
1T6	Refer to chart at end of section.
1U4	Refer to chart at end of section.

Refer to chart at end of section.

1U5

Refer to chart at end of section.

IV

HALF-WAVE VACUUM RECTIFIER

1V2

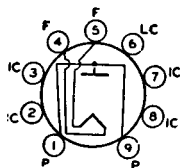

9U

Miniature type used as a doubler in high-voltage pulse rectifier circuits of black-and-white television receivers and as a focus rectifier in color television receivers. The very low power required by the filament permits the use of a rectifier transformer having small size and light weight. Outlines section, 6B; requires miniature 9-contact socket.

Filament Voltage (ac)	0.625*	volt
Filament Current	0.3	ampere
Direct Interelectrode Capacitance:		
Plate to Filament (Approx.)	0.8	pF

* Under no circumstances should the filament voltage be less than 0.525 volt or greater than 0.725 volt.

Pulsed Rectifier

For operation in a 525-line, 30-frame system

MAXIMUM RATINGS (Design-Maximum Values)

Peak Inverse Plate Voltage#	8250*	volts
Peak Plate Current	11	mA
Average Plate Current	0.6	mA

Pulse duration must not exceed 15% of a horizontal scanning cycle (10 microseconds).

* The dc component must not exceed 7000 volts.

Refer to chart at end of section.

1X2A

Refer to chart at end of section.

1X2B
1X2B/1X2A

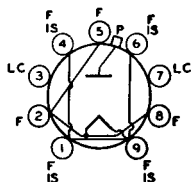

9Y

HALF-WAVE VACUUM RECTIFIER

1X2C

Miniature type used as a rectifier in high-voltage pulse circuits of black-and-white television receivers and as a focus rectifier in color television receivers. Outlines section, 7A; requires miniature 9-contact socket. Socket terminals 3 and 7 may be used as tie points for components at or near filament potential. For high-voltage and X-ray safety considerations, refer to page 93.

Filament Voltage (ac)	1.25	volts
Filament Current	0.2	ampere
Direct Interelectrode Capacitance:		
Plate to Filament and Internal Shield (Approx.)	1	pF

Flyback Rectifier

For operation in a 525-line, 30-frame system

MAXIMUM RATINGS (Design-Maximum Values)

Peak Inverse Plate Voltage#	22000*	volts
Peak Plate Current	45	mA
Average Plate Current	0.5	mA
Filament Voltage:		
Absolute-maximum value	1.45	volts
Absolute-minimum value	1.05	volts

CHARACTERISTIC, Instantaneous Value

Tube Voltage Drop for plate current of 7 mA	80	volts
---------------------------------------------------	----	-------

X-RADIATION CHARACTERISTIC

X-Radiation, Maximum:

Statistical value controlled on a lot sampling basis 0.5 mR/hr

Pulse duration must not exceed 15% of a horizontal scanning cycle (10 microseconds).

* The dc component must not exceed 18000 volts.

Caution—Operation of this tube outside of the maximum values indicated above may result in either temporary or permanent changes in the X-radiation characteristic of the tube. Equipment design must be such that these maximum values are not exceeded.**2A3** Refer to chart at end of section.**2A5** Refer to chart at end of section.**2A6** Refer to chart at end of section.**2A7** Refer to chart at end of section.**2AF4A** Refer to chart at end of section.**2AF4B** Refer to chart at end of section.**2AF4B/2DZ4** Refer to type 6AF4A.**2AH2** Refer to chart at end of section.
For replacement use type 2BU2/2AH2.**2AS2** Refer to chart at end of section.**2AS2A****HALF-WAVE
VACUUM RECTIFIER**

Duodecar type used as a rectifier in high-voltage pulse circuits of color television receivers. **Outlines section, 9B**; requires duodecar 12-contact socket. Socket terminals 4, 7, and 10 may be used as tie points for components at or near heater potential. For high-voltage and X-ray safety considerations, refer to page 93. **Heater:** volts (ac/dc), 2.5; amperes, 0.33.

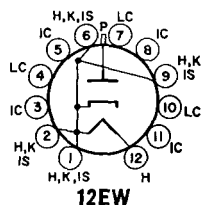
**12EW****Pulsed Rectifier**

For operation in a 525-line, 30-frame system

MAXIMUM RATINGS (Design-Maximum Values)

Peak Inverse Plate Voltage#	30000*	volts
Peak Plate Current	90	mA
Average Plate Current	1.7	mA

CHARACTERISTIC, Instantaneous Value

Tube Voltage Drop for plate current of 7 mA	75	volts
---------------------------------------------	----	-------

X-RADIATION CHARACTERISTIC

X-Radiation, Maximum:

Statistical value controlled on a lot sampling basis 25 mR/hr

Pulse duration must not exceed 15% of a horizontal scanning cycle (10 microseconds).

* The dc component must not exceed 24000 volts.

Caution—Operation of this tube outside of the maximum values indicated above may result in either temporary or permanent changes in the X-radiation characteristic of the tube. Equipment design must be such that these maximum values are not exceeded.

**HALF-WAVE
VACUUM RECTIFIER**

2AV2

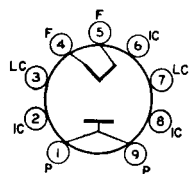

9U

Miniature type used as a high-voltage, low-current pulse-operated focus rectifier in color television receivers. The filament of the tube can be operated directly across the filament winding of the horizontal-output transformer without a series voltage-dropping resistor. Outlines section, 6B; requires miniature 9-contact socket.

Filament Voltage (ac)	1.8*	volts
Filament Current	0.225	ampere
Direct Interelectrode Capacitance (Approx.):		
Plate to Filament	0.8	pF

Pulsed Rectifier

For operation in a 525-line, 30-frame system

MAXIMUM RATINGS (Design-Maximum Values)

Peak Inverse Plate Voltage#	3250**	volts
Peak Plate Current	50	mA
Average Plate Current	0.6	mA

CHARACTERISTIC, Instantaneous Value

Tube Voltage Drop for plate current of 1 mA	20	volts
---------------------------------------------	----	-------

Pulse duration must not exceed 15% of a horizontal scanning cycle (10 microseconds).
 ** Under no circumstances should this absolute value be exceeded; the dc component must not exceed 7000 volts.
 * Under no circumstances should the filament voltage be less than 1.53 volts or greater than 2.07 volts.

Refer to chart at end of section. **2B7**

Refer to chart at end of section. **2BA2**

Refer to chart at end of section. **2BJ2**
2BJ2A

Refer to chart at end of section. **2BN4**

Refer to type 6BN4A. **2BN4A**

Refer to type 2BU2/2AH2 **2BU2**

**2BU2/
2AH2**

**HALF-WAVE
VACUUM RECTIFIER**

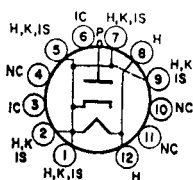

12JB

Duodecar type used as a high-voltage rectifier to supply power to the anode of the picture tube in television receivers. Outlines section, 9B; requires 12-contact socket. Socket terminals 4, 10, and 11 may be used as tie points for components at or near heater potential. For high-voltage and X-ray safety considerations, refer to page 93. Heater: volts (ac/dc), 2.5; ampere, 0.33.

Flyback Rectifier

For operation in a 525-line, 30-frame system

MAXIMUM RATINGS (Design-Maximum Values)

Peak Inverse Plate Voltage#	30000*	volts
Peak Plate Current	80	mA
Average Plate Current	1.5	mA
Heater Voltage:		
Absolute-maximum value	2.9	volts
Absolute-minimum value	2.1	volts

CHARACTERISTIC, Instantaneous Value

Tube Voltage Drop (Approx.), for plate current of 7 mA	60	volts
--------------------------------------------------------	----	-------

X-RADIATION CHARACTERISTIC

X-Radiation, Maximum:		
Statistical value controlled on a lot sampling basis	0.5	mR/hr

Pulse duration must not exceed 15% of a horizontal scanning cycle (10 microseconds).

* The dc component must not exceed 24000 volts.

Caution—Operation of this tube outside of the maximum values indicated above may result in either temporary or permanent changes in the X-radiation characteristic of the tube. Equipment design must be such that these maximum values are not exceeded.

2CN3A

Refer to chart at end of section.

2CW4

Refer to type 6CW4.

2CY5

Refer to type 6CY5.

2D21

INDUSTRIAL
TYPE

GAS THYRATRON

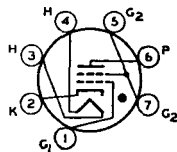

7BN

Miniature type gas-tetrode thyatron intended for relay applications. Outlines section, 5C; requires miniature 7-contact socket.

Heater Voltage (ac/dc)	6.3 ± 10%	volts
Heater Current	0.6	ampere
Cathode:		
Heating time prior to tube conduction	10	seconds
Heater-Cathode Voltage:		
Peak value	-100 +25	volts
Direct Interelectrode Capacitances (Approx.):		
Grid-No. 1 to anode	0.026	pF
Input	2.4	pF
Output	1.6	pF
Ionization Time (Approx.):		
For conditions: dc anode volts = 100; grid-No. 1 square-pulse volts = 50; peak anode amp. during conduction = 0.5	0.5	μs
Deionization Time (Approx.):		
For conditions: dc anode volts = 125; grid-No. 1 volts = -100; grid-No. 1 resistor (ohms) = 1000; ac anode amp. = 0.1	35	μs
For conditions: dc anode volts = 125; grid-No. 1 volts = -10; grid-No. 1 resistor (ohms) = 1000, dc anode amp. = 0.1	75	μs
Maximum Critical Grid-No. 1 Current with an anode-supply volts (rms) = 460, and average anode amp. = 0.1	0.5	μA
Anode Voltage Drop (Approx.)	8	volts
Grid-No. 1 Control Ratio (Approx.) with grid-No. 1 resistor (megohms) = 0; grid-No. 2 volts = 0	250	
Grid-No. 2 Control Ratio (Approx.) with grid-No. 1 resistor (megohms) = 0; grid-No. 2 resistor (megohms) = 0; grid-No. 1 volts = 0	1000	

Relay and Grid-Controlled Rectifier Service

MAXIMUM RATINGS (Absolute-Maximum Values)

Peak Anode Voltage:		
Forward	650	volts
Inverse	1300	volts
Grid-No. 2 (Shield-Grid) Voltage:		
Peak, before anode conduction	-100	volts
Average, during anode conduction	-10	volts

Grid-No. 1 (Control-Grid) Voltage:		
Peak, before anode conduction	—100	volts
Average, during anode conduction [■]	—10	volts
Cathode Current:		
Peak	0.5	ampere
Average [■]	0.1	ampere
Fault, for duration of 0.1 sec. max.	10	amperes
Grid-No. 2 Current:		
Average [■]	+0.01	ampere
Grid-No. 1 Current:		
Average [■]	+0.01	ampere
Ambient Temperature Range	—75 to +90	°C

Operational Range of Critical Grid-No. 1 Voltage.

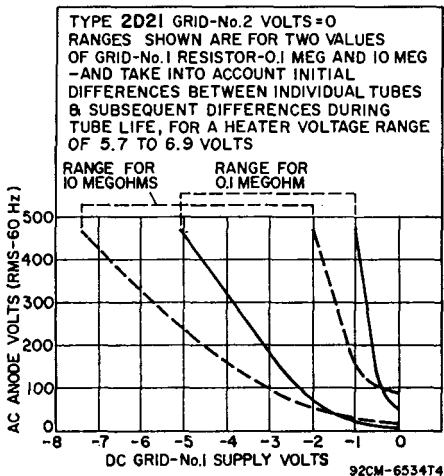

TYPICAL OPERATING CONDITIONS FOR RELAY SERVICE

RMS Anode Voltage	117	400	volts
Grid-No.2 Voltage	0	0	volts
RMS Grid-No.1 Bias Voltage [□]	5	—	volts
DC Grid-No.1 Bias Voltage	—	—6	volts
Peak Grid-No.1 Signal Voltage	5	6	volts
Grid-No.1-Circuit Resistance	1.0	1.0	megohm
Anode-Circuit Resistance [#]	1200	2000	ohms

MAXIMUM CIRCUIT VALUE

Grid-No.1-Circuit Resistance	10	megohms
------------------------------	----	---------

[■] Averaged over any interval of 30 seconds maximum.

[□] Approximately 180° out of phase with the anode voltage.

[#] Sufficient resistance, including the tube load, must be used under any conditions of operation to prevent exceeding the current ratings.

Refer to chart at end of section.

2D21W

Refer to type 6DS4.

2DS4

Refer to type 6DV4.

2DV4

Refer to chart at end of section.
 For replacement use type 2AF4B/2DZ4.

2DZ4

Refer to chart at end of section.

2E5

2EG4

HIGH-MU TRIODE

Nuvistor type used as a grounded-cathode, neutralized rf amplifier in vhf tuners of television and FM receivers. Outlines section, 1; requires nuvistor socket.

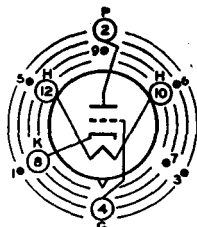

INDEX—LARGE LUG
●—SHORT PIN—IC

12AQ

Heater Voltage (ac/dc)	1.7	volts
Heater Current	0.6	ampere
Heater Warm-up Time (Average)	8	seconds
Peak Heater-Cathode Voltage	±100	volts

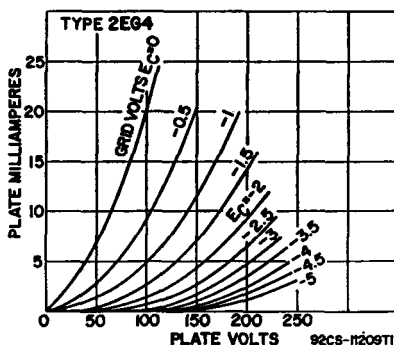

Direct Interelectrode Capacitances (Approx.):

Grid to Plate	0.92	pF
Grid to Cathode, Heater, and Shell	4.3	pF
Plate to Cathode, Heater, and Shell	1.8	pF
Plate to Cathode	0.18	pF
Heater to Cathode	1.6	pF

Class A₁ Amplifier

MAXIMUM RATINGS (Design-Maximum Values)

Plate Supply Voltage	300*	volts
Plate Voltage	135	volts
Grid Voltage:		
Negative-bias value	55	volts
Peak or dc positive value	0	volts
Plate Dissipation	1.5	watts
Cathode Current	15	mA

CHARACTERISTICS AND TYPICAL OPERATION

	Characteristics	Typical Operation	
Plate Supply Voltage	110	70	volts
Grid Supply Voltage	—	0	volts
Cathode-Bias Resistor	130	—	ohms
Grid Resistor	—	47000	ohms
Amplification Factor	63	68	
Plate Resistance (Approx.)	7000	5440	ohms
Transconductance	9000	12500	μmhos
Grid Voltage (Approx.) for plate current of 100 μA	—5	—	volts
Grid Voltage (Approx.) for plate current of 10 μA	—6.8	—	volts
Plate Current	6.5	7	mA

MAXIMUM CIRCUIT VALUES

Grid-Circuit Resistance:*		
For fixed-bias operation	2.2	megohms
For cathode-bias operation	0.5	megohm

* A plate supply voltage of 300 volts may be used provided that a sufficiently large resistor is used in the plate circuit to limit the plate dissipation to 1.5 watts under any condition of operation.

* For operation at metal-shell temperatures up to 135° C.

Refer to chart at end of section.	2EN5
Refer to chart at end of section.	2ER5
Refer to type 6FH5.	2FH5
Refer to chart at end of section. For replacement use type 2GK5/2FQ5A.	2FQ5A
Refer to type 6FS5.	2FS5
Refer to chart at end of section.	2GK5
Refer to type 6GK5.	2GK5/2FQ5A
Refer to chart at end of section. For replacement use type 2GU5.	2GU5
For replacement use type 2HM5/2HA5.	2HA5
Refer to type 6HM5/6HA5.	2HM5/2HA5
Refer to type 6HQ5.	2HQ5
Refer to chart at end of section.	3A2

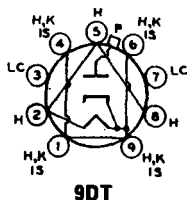

**HALF-WAVE
VACUUM RECTIFIER**

3A2A

Miniature type used in high-voltage rectifier circuits of small-screen black-and-white television receivers. Outlines section, 7A; requires miniature 9-contact socket. Socket terminals 1, 3, 4, 6, and 7 may be connected to terminal 9 or to a corona shield which connects to terminal 9. Terminals 3 and 7 may be used as tie points

at or near cathode potential. For high-voltage and X-ray safety considerations, refer to page 93.

Heater Voltage (ac/dc)	3.15	volts
Heater Current	0.22	ampere
Direct Interelectrode Capacitances:		
Plate to Cathode, Heater, and Internal Shield	1	pF

Pulsed Rectifier

For operation in a 525-line, 30-frame system

MAXIMUM RATINGS (Design-Maximum Ratings)

Peak Inverse Plate Voltage*	20000	volts
Peak Plate Current	80	mA
Average Plate Current	1.5	mA
Heater Voltage:		
Absolute-maximum value	3.65	volts
Absolute-minimum value	2.65	volts

CHARACTERISTIC, Instantaneous Value

Tube Voltage Drop for plate current of 7 mA	70	volts
---------------------------------------------------	----	-------

X-RADIATION CHARACTERISTIC

X-Radiation, Maximum:		
Statistical value controlled on a lot sampling basis	0.5	mR/hr

* Pulse duration must not exceed 15% of a horizontal scanning cycle (10 microseconds).
 • The dc component must not exceed 18000 volts.

Caution—Operation of this tube outside of the maximum values indicated above may result in either temporary or permanent changes in the X-radiation characteristic of the tube. Equipment design must be such that these maximum values are not exceeded.

3A3	Refer to chart at end of section.
3A3/3B2	Refer to chart at end of section.
3A3A 3A3A/3B2	Refer to chart at end of section.
3A3B	Refer to chart at end of section.

3A3C HALF-WAVE VACUUM RECTIFIER

Glass octal type used as a rectifier in high-voltage pulse circuits of color television receivers. Outlines section, 14F; requires octal socket. Socket terminals 1, 3, 4, 5, 6, and 8 may be connected to terminal 7. Socket terminals 4 and 6 may be used as tie points at or near cathode potential. For high-voltage and X-ray safety considerations, refer to page 93.

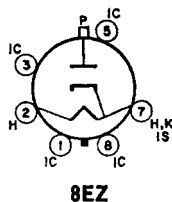

Heater Voltage (ac)	3.15	volts
Heater Current	0.22	ampere
Direct Interelectrode Capacitances:		
Plate to Heater, Cathode, and Internal Shield	1.5	pF

Pulsed Rectifier

MAXIMUM RATINGS (Design-Maximum Values)

Peak Inverse Plate Voltage#	35000*	volts
Peak Plate Current	100	mA
Average Plate Current	2	mA
Heater Voltage:		
Absolute-maximum value	3.65	volts
Absolute-minimum value	2.65	volts

CHARACTERISTIC, Instantaneous Value

Tube Voltage Drop (Approx.) for plate current of 7 mA	100	volts
-------------------------------------------------------	-----	-------

X-RADIATION CHARACTERISTIC

X-Radiation, Maximum:		
Statistical value controlled on a lot sampling basis	25	mR/hr
# Pulse duration must not exceed 15% of a horizontal scanning cycle (10 microseconds).		
* DC component must not exceed 30000 volts.		
Caution—Operation of this tube outside of the maximum values indicated above may result in either temporary or permanent changes in the X-radiation characteristic of the tube. Equipment design must be such that these maximum values are not exceeded.		

3A4	Refer to chart at end of section.
------------	-----------------------------------

3A5 INDUSTRIAL TYPE

H-F TWIN TRIODE

Miniature type twin triode used as a A-F power amplifier or an R-F power amplifier or oscillator. Each triode can be used independently of the other. Outlines section, 5C; requires miniature 7-contact socket.

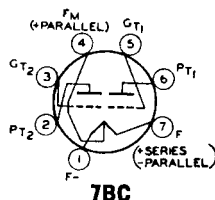

Filament Arrangement	Series*	Parallel**	
Filament Voltage (dc)	2.8	1.4	volts
Filament Current	0.11	0.22	ampere

Direct Interelectrode Capacitances:	Unit No. 1	Unit No. 2	
Grid to Plate	3.2	3.2	pF
Grid to Filament	0.9	0.9	pF
Plate to Filament	1.0	1.0	pF
Plate to Plate		0.32	pF

A-F Power Amplifier (Each Unit)

MAXIMUM RATINGS (Design-Center Values)

Plate Voltage	135	volts
Plate Current	5	mA
Plate Dissipation	0.5	watt

CHARACTERISTICS

Plate Voltage	90	volts
Grid Voltage	-2.5	volts
Amplification Factor	15	
Plate Resistance	8300	ohms
Transconductance	1800	μmbhos
Plate Current	3.7	mA

R-F Power Amplifier and Oscillator—Class C Telegraphy

Key-down conditions per tube without modulation

MAXIMUM RATINGS (Design-Center Values)

DC Plate Voltage	135	volts
DC Grid Voltage	-30	volts
DC Plate Current (per unit)	15	mA
DC Grid Current (per unit)	2.5	mA
Plate Input (per unit)	2.0	watts
Plate Dissipation (per unit)	1.0	watt

TYPICAL OPERATION (At 40 MHz With Both Units In Push-Pull)

DC Plate Voltage	135	volts
DC Grid Voltage ●	-20	volts
	4000	ohms
	570	ohms
Peak R-F Grid-to-Grid Voltage	90	volts
DC Plate Current	30	mA
DC Grid Current (approx.)	5	mA
Driving Power (approx.)	0.2	watt
Power Output (approx.)	2	watts

* Filament voltage applied across two sections in series between pins No. 1 and No. 7. Grid voltage is referred to pin No. 1. For series filament operation, a shunting resistor must be connected across the section between pins No. 1 and No. 4, to by-pass excess cathode current in this section. The value of the shunting resistor should be adjusted to make the voltage across the shunted section equal to the voltage across the section between pins No. 4 and No. 7. When other tubes in series-filament arrangement contribute to the filament current of the 3A5, an additional shunting resistor may be required between pins No. 1 and No. 7.

** Filament voltage applied across the two sections in parallel between pin No. 4 and pins No. 1 and No. 7 connected together. Grid voltage is referred to pins No. 1 and No. 7 tied together.

● Obtained by grid resistor (4000), cathode resistor (570), or fixed supply.

Refer to chart at end of section. **3A8GT**

Refer to chart at end of section. **3AF4A**

Refer to type 6AF4A. **3AF4A/3DZ4**

Refer to type 6AL5. **3AL5**

Refer to chart at end of section. **3AT2**

3AT2B**HALF-WAVE
VACUUM RECTIFIER**

Duodecar type used as a high-voltage rectifier to supply power to the anode of the television picture tube. Outlines section, 9B; requires duodecar 12-contact socket. Socket terminals 4, 7, and 10 may be used as tie points for components at or near filament potential. For high-voltage and X-ray safety considerations, refer to page 93. Heater: volts (ac/dc), 3.15; ampere, 0.22.

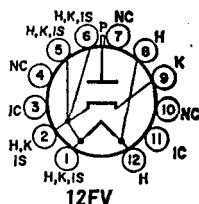
**Flyback Rectifier**

For operation in a 525-line, 30-frame system

MAXIMUM RATINGS (Design-Maximum Values)

Peak Inverse Plate Voltage#	38000*	volts
Peak Plate Current	88	mA
Average Plate Current	1.7	mA
Heater Voltage:		
Absolute-maximum value	3.65	volts
Absolute-minimum value	2.65	volts

CHARACTERISTIC, Instantaneous Value

Tube Voltage Drop for plate current of 7 mA	60	volts
---------------------------------------------	----	-------

X-RADIATION CHARACTERISTIC**X-Radiation, Maximum:**

Statistical value controlled on a lot sampling basis	25	mR/hr
------------------------------------------------------	----	-------

Pulse duration must not exceed 15% of a horizontal scanning cycle (10 microseconds).

* The dc component must not exceed 30000 volts.

Caution—Operation of this tube outside of the maximum values indicated above may result in either temporary or permanent changes in the X-radiation characteristic of the tube. Equipment design must be such that these maximum values are not exceeded.

3AU6

Refer to type 6AU6A.

3AV6

Refer to chart at end of section.

3AW2

Refer to chart at end of section.

3AW2A**HALF-WAVE
VACUUM RECTIFIER**

Duodecar type used as a high-voltage rectifier to supply power to the anode of the picture tube in color and black-and-white television receivers. Outlines section, 9B; requires duodecar 12-contact socket. Socket terminals 4, 7, and 10 may be used as tie points at or near heater potential. For high-voltage and X-ray safety considerations, refer to page 93. Heater: volts (ac/dc), 3.15; ampere, 0.35.

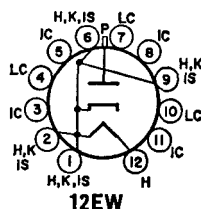
**Pulsed Rectifier**

For operation in a 525-line, 30-frame system

MAXIMUM RATINGS (Design-Maximum Values)

Peak Inverse Plate Voltage#	38000*	volts
Peak Plate Current	110	mA
Average Plate Current	2.2	mA
Heater Voltage:		
Absolute-maximum value	3.65	volts
Absolute-minimum value	2.65	volts

CHARACTERISTIC, Instantaneous Value

Tube Voltage Drop for plate current of 7 mA	60	volts
---------------------------------------------	----	-------

X-RADIATION CHARACTERISTIC

X-Radiation, Maximum:

Statistical value controlled on a lot sampling basis 25 mR/hr

Pulse duration must not exceed 15% of a horizontal scanning cycle (10 microseconds).

*The dc component must not exceed 30000 volts.

Caution—Operation of this tube outside of the maximum values indicated above may result in either temporary or permanent changes in the X-radiation characteristic of the tube. Equipment design must be such that these maximum values are not exceeded.

Refer to chart at end of section.	3AW3
Refer to chart at end of section.	3B2
Refer to chart at end of section.	3B4WA
Refer to chart at end of section.	3BA6
Refer to chart at end of section.	3BC5
Refer to type 6BC5.	3BC5/3CE5
Refer to chart at end of section.	3BE6
Refer to chart at end of section.	3BL2
Refer to chart at end of section.	3BL2A
Refer to chart at end of section.	3BM2
Refer to chart at end of section.	3BN2
Refer to chart at end of section.	3BN2A
Refer to chart at end of section.	3BN4
Refer to type 6BN4A.	3BN4A
Refer to type 6BN6.	3BN6
Refer to chart at end of section.	3BS2A
For replacement use type 3BW2/3BS2A/3BT2.	3BT2
For replacement use type 3BW2/3BS2A/3BT2.	3BU8
Refer to chart at end of section.	3BU8/3GS8
Refer to type 6BU8.	3BW2
For replacement use type 3BW2/3BS2A/3BT2.	

**3BW2/
3BS2A/
3BT2**

**HALF-WAVE
VACUUM RECTIFIER**

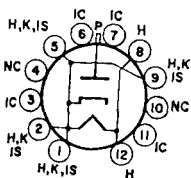

12HY

Duodecar type used as a high-voltage rectifier to supply power to the anode of the picture tube in color television receivers. Outlines section, 9B; requires octal socket. Socket terminals 4 and 10 may be used as tie points for components at or near heater potential. For high-voltage and X-ray safety considerations, refer to page 93.

Heater Voltage (ac/dc)	3.15	volts
Heater Current	0.48	ampere
Direct Interelectrode Capacitance (Approx.):		
Plate to Cathode, Heater, and Internal Shield	1.6	pF

Flyback Rectifier

For operation in a 525-line, 30-frame system

MAXIMUM RATINGS (Design-Maximum Values)

Peak Inverse Plate Voltage#	38000*	volts
Peak Plate Current	110	mA
Average Plate Current	2.2	mA
Heater Voltage:		
Absolute-maximum value	3.65	volts
Absolute-minimum value	2.65	volts

CHARACTERISTIC, Instantaneous Value

Tube Voltage Drop (Approx.), for plate current of 7 mA	70	volts
--------------------------------------------------------	----	-------

X-RADIATION CHARACTERISTIC

X-Radiation, Maximum:		
Statistical value controlled on a lot sampling basis	25	mR/hr

Pulse duration must not exceed 15% of a horizontal scanning cycle.

* The dc component must not exceed 30000 volts.

Caution—Operation of this tube outside of the maximum values indicated above may result in either temporary or permanent changes in the X-radiation characteristic of the tube. Equipment design must be such that these maximum values are not exceeded.

3BY6

Refer to chart at end of section.
For replacement use type 3CS6.

3BZ6

Refer to type 6BZ6.

3CA3

Refer to chart at end of section.

3CA3A

HALF-WAVE VACUUM RECTIFIER

Glass octal type used as a rectifier in high-voltage pulse circuits of color television receivers. Outlines section, 14E; requires octal socket. Socket terminals 1, 3, 4, 5, 6, and 8 may be connected to terminal 7 or to a corona shield which connects to terminal 7. Socket terminals 4 and 6 may be used as tie points at or near cathode potential. For high-voltage and X-ray safety considerations, refer to page 93.

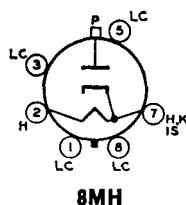

Heater Voltage (ac)	3.6	volts
Heater Current	0.225	ampere
Direct Interelectrode Capacitance (Approx.):		
Plate to Heater, Cathode, and Internal Shield	1.6	pF

Pulsed Rectifier

For operation in a 525-line, 30-frame system

MAXIMUM RATINGS (Design-Maximum Values)

Peak Inverse Plate Voltage#	38000*	volts
Peak Plate Current	100	mA
Average Plate Current	2	mA
Heater Voltage:		
Absolute-maximum value	4.14	volts
Absolute-minimum value	3.06	volts

CHARACTERISTIC, Instantaneous Value

Tube Voltage Drop for plate current of 11 mA	60	volts
----------------------------------------------	----	-------

X-RADIATION CHARACTERISTIC

X-Radiation, Maximum:		
Statistical value controlled on a lot sampling basis	25	mR/hr

Pulse duration must not exceed 15% of a horizontal scanning cycle (10 microseconds).

* The dc component must not exceed 30000 volts.

Caution—Operation of this tube outside of the maximum values indicated above may result in either temporary or permanent changes in the X-radiation characteristic of the tube. Equipment design must be such that these maximum values are not exceeded.

For replacement use type 3CB6/3CF6.

3CB6

Refer to type 6CB6A.

3CB6/3CF6

Refer to chart at end of section.

For replacement use type 3BC5/3CE5.

3CE5

Refer to chart at end of section.

For replacement use type 3CB6/3CF6.

3CF6

Refer to chart at end of section.

3CN3A

**HALF-WAVE
VACUUM RECTIFIER**

3CN3B

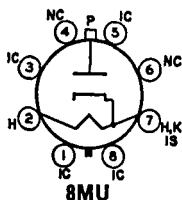

Glass octal type used as a high-voltage rectifier to supply power to the anode of the picture tube in color and black-and-white television receivers. Outlines section, 14F; requires octal socket. Socket terminals 4 and 6 may be used as tie points for components at or near heater potential. For high-voltage and X-ray safety

considerations, refer to page 93.

Heater Voltage (ac/dc)	3.15	volts
Heater Current	0.48	ampere

Flyback Rectifier

For operation in a 525-line, 30-frame system

MAXIMUM RATINGS (Design-Maximum Values)

Peak Inverse Plate Voltage#	38000*	volts
Peak Plate Current	110	mA
Average Plate Current	2.2	mA
Heater Voltage:		
Absolute-maximum value	3.65	volts
Absolute-minimum value	2.65	volts

CHARACTERISTIC, Instantaneous Value

Tube Voltage Drop for plate current of 7 mA	60	volts
---------------------------------------------------	----	-------

X-RADIATION CHARACTERISTIC

X-Radiation, Maximum:		
Statistical value controlled on a lot sampling basis	25	mR/hr

Pulse duration must not exceed 15% of a horizontal scanning cycle (10 microseconds).

* The dc component must not exceed 30000 volts.

Caution—Operation of this tube outside of the maximum values indicated above may result in either temporary or permanent changes in the X-radiation characteristic of the tube. Equipment design must be such that these maximum values are not exceeded.

Refer to type 6CS6.

3CS6

**HALF-WAVE
VACUUM RECTIFIER**

3CU3A

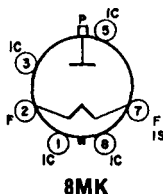

Glass octal type used as a rectifier in high-voltage circuits of color and black-and-white television receivers. Because of its fast warm-up time it is particularly suited for transistorized systems. Outlines section, 14F; requires octal socket. Socket terminals 4 and 6 may be used as tie points. For high-voltage and X-ray safety considerations, refer to page 93.

Filament Voltage:	3.15	volts
Filament Current (ac)	0.28	ampere
Direct Interelectrode Capacitance:		
Plate to Filament and Shield	1.5	pF

Pulsed Rectifier

For operation in a 525-line, 30-frame system

MAXIMUM RATINGS (Design-Maximum Values)

Peak Inverse Plate Voltage#	33000 ^m	volts
Peak Plate Current	100	mA
Average Plate Current	2	mA
Filament Voltage:		
Absolute-maximum value	3.65	volts
Absolute-minimum value	2.65	volts

CHARACTERISTIC, Instantaneous Value

Tube Voltage Drop for plate current of 7 mA	50	volts
---------------------------------------------	----	-------

X-RADIATION CHARACTERISTIC

X-Radiation, Maximum:		
Statistical value controlled on a lot sampling basis	25	mR/hr

Pulse duration must not exceed 15% of a horizontal scanning cycle (10 microseconds).
 * The dc component must not exceed 30000 volts.

Caution—Operation of this tube outside of the maximum values indicated above may result in either temporary or permanent changes in the X-radiation characteristic of the tube. Equipment design must be such that these maximum values are not exceeded.

3CX3

Refer to chart at end of section.
 For replacement use type 3DA3/3DH3.

3CY3

For replacement use type 3DB3/3CY3.

3CY5

Refer to type 6CY5.

3CZ3

For replacement use type 3CZ3A.

3CZ3A

HALF-WAVE VACUUM RECTIFIER

Glass octal type for use in the high-voltage rectifier circuits of television receivers and in other high voltage applications. Outlines section, 34A; requires octal socket. Socket terminals 1, 3, 4, 5, 6, and 8 may be connected to socket terminal 7. Socket terminals 4 and 6 may be used as tie points for components at or near heater potential. For high-voltage and X-ray safety considerations, refer to page 93.

Heater Voltage	3.15	volts
Heater Current	0.48	ampere
Heater Warm-up Time	4	seconds
Direct Interelectrode Capacitance:		
Plate to Heater, Cathode, and Internal Shield	1.6	pF

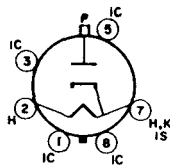

8EZ

Pulsed Rectifier

For operation in a 525-line, 30-frame system

MAXIMUM RATINGS (Design-Maximum Values)

Peak Inverse Plate Voltage#	38000 ^o	volts
Peak Plate Current	110	mA
Average Plate Current	2.2	mA
Heater Voltage:		
Absolute-maximum value	3.65	volts
Absolute-minimum value	2.65	volts

CHARACTERISTIC, Instantaneous Value

Tube Voltage Drop for plate current of 7 mA	60	volts
---------------------------------------------	----	-------

X-RADIATION CHARACTERISTIC

X-Radiation, Maximum:		
Statistical value controlled on a lot sampling basis	25	mR/hr

Pulse duration must not exceed 15% of a horizontal scanning cycle (10 microseconds).
 * The dc component must not exceed 30000 volts.

Caution—Operation of this tube outside of the maximum values indicated above may result in either temporary or permanent changes in the X-radiation characteristic of the tube. Equipment design must be such that these maximum values are not exceeded.

Refer to chart at end of section.

3DA3/3DH3

Refer to type 3DB3/3CY3.

3DB3

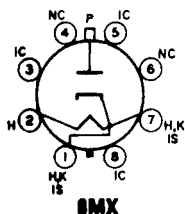

**HALF-WAVE
VACUUM RECTIFIER**

3DB3/3CY3

Octal type used as a high-voltage rectifier to supply power to the anode of the television picture tube. Outlines section, 14F; requires octal socket. Socket terminals 3, 4, 5, 6, and 8 should not be used as tie points although terminals 3, 5, and 8 may be connected to terminal 7. For high-voltage and X-ray safety considerations, refer to page 93.

Heater Voltage	3.15	volts
Heater Current	0.246	ampere
Direct Interelectrode Capacitance (Approx.):		
Plate to Heater, Cathode, and Internal Shield	1.5	pF

Flyback Rectifier

For operation in a 525-line, 30-frame system

MAXIMUM RATINGS (Design-Maximum Values)

Peak Inverse Plate Voltage#	38000 ^o	volts
Peak Plate Current	100	mA
Average Plate Current	2	mA
Heater Voltage:		
Absolute-maximum value	3.65	volts
Absolute minimum value	2.65	volts

CHARACTERISTIC, Instantaneous Value

Tube Voltage Drop for plate current of 7 mA	100	volts
---------------------------------------------------	-----	-------

X-RADIATION CHARACTERISTIC

X-Radiation, Maximum:		
Statistical value controlled on a lot sampling basis	25	mR/hr

Pulse duration must not exceed 15% of a horizontal scanning cycle (10 microseconds).

^o The dc component must not exceed 30000 volts.

Caution—Operation of this tube outside of the maximum values indicated above may result in either temporary or permanent changes in the X-radiation characteristic of the tube. Equipment design must be such that these maximum values are not exceeded.

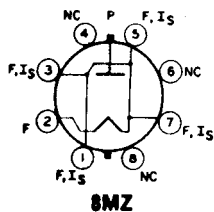

**HALF-WAVE
VACUUM RECTIFIER**

3DC3

Glass octal type used as a rectifier in high-voltage circuits of color and black-and-white television receivers. Because of its fast warm-up time it is particularly suited for transistorized systems. Outlines section, 14F; requires octal socket. Socket terminals 4, 6, and 8 may be used as tie points. For high-voltage and X-ray safety considerations, refer to page 93. This type is identical with type 3CU3A except for the following items:

Pulsed Rectifier

For operation in a 525-line, 30-frame system

MAXIMUM RATINGS (Design-Maximum Values)

Peak Plate Current	110	mA
Average Plate Current	2.2	mA

3DF3**HALF-WAVE
VACUUM RECTIFIER**

3DF3A

Glass octal types used as a high-voltage rectifier to supply power to the anode of the picture tube in television receivers. Outlines section, 14G and 14H, respectively; requires octal socket. Socket terminals 1 and 7 may be used as tie points for components at or near heater potential. For high-voltage and X-ray safety considerations, refer to page 93. Heater: volts (ac/dc), 3.15; ampere, 0.48.

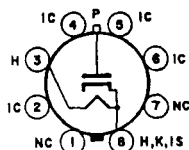

8MT

Flyback Rectifier

For operation in a 525-line, 30-frame system

MAXIMUM RATINGS (Design-Maximum Values)

Peak Inverse Plate Voltage#	38000●	volts
Peak Plate Current	110	mA
Average Plate Current	2.2	mA
Heater Voltage:		
Absolute maximum value	3.65	volts
Absolute-minimum value	2.65	volts

CHARACTERISTIC, Instantaneous Value

Tube Voltage Drop for plate current of 7 mA	60	volts
---------------------------------------------	----	-------

X-RADIATION CHARACTERISTIC**X-Radiation, Maximum:**

Statistical value controlled on a lot sampling basis	3DF3 25	3DF3A 8	mR/hr
------------------------------------------------------	-------------------	-------------------	-------

Pulse duration must not exceed 15% of a horizontal scanning cycle.

● The dc component must not exceed 30000 volts.

Caution—Operation of this tube outside of the maximum values indicated above may result in either temporary or permanent changes in the X-radiation characteristic of the tube. Equipment design must be such that these maximum values are not exceeded.

3DG4**FULL-WAVE
VACUUM RECTIFIER**

3DH3

Glass octal type used in power supplies of color and black-and-white television receivers and other equipment having high dc requirements. Outlines section, 19E; requires octal socket. It is especially important that this tube, like other power-handling tubes, be adequately ventilated. For discussion of Rating Chart, refer to Interpretation of Tube Data. Filament: volts (ac/dc), 3.3; amperes, 3.8.

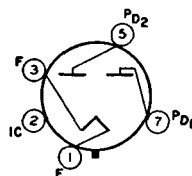

5DE

Full-Wave Rectifier**MAXIMUM RATINGS (Design-Maximum Values)**

Peak Inverse Plate Voltage	1050	volts
Peak Plate Current (Per Plate)	1.2	amperes
Hot-Switching Transient Plate Current (Per Plate)	6.5	amperes
AC Plate Supply Voltage (Per Plate, rms)	See Rating Chart	
DC Output Current (Per Plate)	See Rating Chart	
Bulb Temperature (At hottest point on bulb surface)	200	°C

TYPICAL OPERATION WITH CAPACITOR INPUT TO FILTER

AC Plate-to-Plate Supply Voltage (rms)	550	volts
Filter-Input Capacitor*	40	μF
Effective Plate-Supply Impedance per Plate	32	ohms
DC Output Voltage at Input to Filter (Approx.):		
At full-load current of 350 mA	300	volts

CHARACTERISTICS

Tube Voltage Drop for plate current of 350 mA (per plate)	25	volts
-----------------------------------------------------------	----	-------

* Higher values of capacitance than indicated may be used, but the effective plate-supply impedance may have to be increased to prevent exceeding the maximum peak-plate-current rating.

RATING CHART

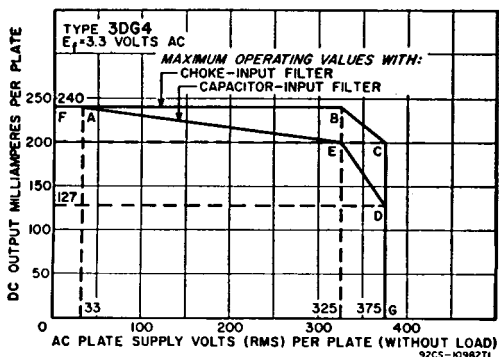

For replacement use type 3DA3/3DH3.

3DH3

**HALF-WAVE
VACUUM RECTIFIER**

3DJ3

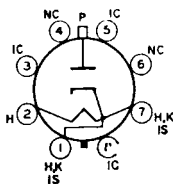

8MX

Glass octal type used as a high-voltage rectifier to supply power to the anode of the picture tube in color television receivers. Outlines section, 14H; requires octal socket. Socket terminals 4 and 6 may be used as tie points for components at or near heater potential. For high-voltage and X-ray safety considerations, refer to page 93. Heater: volts (ac/dc), 3.15; ampere, 0.3.

Flyback Rectifier

For operation in a 525-line, 30-frame system

MAXIMUM RATINGS (Design-Maximum Values)

Peak Inverse Plate Voltage#	38000●	volts
Peak Plate Voltage	100	mA
Average Plate Current	2	mA
Heater Voltage:		
Absolute maximum value	3.65	volts
Absolute-minimum value	2.65	volts

CHARACTERISTIC, Instantaneous Value

Tube Voltage Drop for plate current of 7 mA	70	volts
---------------------------------------------	----	-------

X-RADIATION CHARACTERISTIC

X-Radiation, maximum:		
Statistical value controlled on a lot sampling basis	25	mR/hr

Pulse duration must not exceed 15% of a horizontal scanning cycle.

● The dc component must not exceed 30000 volts.

Caution—Operation of this tube outside of the maximum values indicated above may result in either temporary or permanent changes in the X-radiation characteristic of the tube. Equipment design must be such that these maximum values are not exceeded.

Refer to type 6DK6.

3DK6

Refer to chart at end of section.

3DR3

Refer to chart at end of section.

3DS3

For replacement use type 3DT6A.

3DT6

Refer to type 6DT6A.

3DT6A

Refer to chart at end of section.

For replacement use type 3AF4A/3DZ4.

3DZ4

Refer to chart at end of section.

3EA5

For replacement use type 3EH7/XF183.

3EH7

3EH7/XF183	Refer to type 6EH7/EF183.
3EJ7	Refer to chart at end of section.
3EJ7/XF184	Refer to type 6EJ7/EF184.
3ER5	Refer to type 6ER5.
3FH5	Refer to chart at end of section.
3FS5	Refer to type 6FS5.
3GK5	Refer to type 6GK5.
3GS8	Refer to chart at end of section. For replacement use type 3BU8/3GS8.
3GS8/3BU8	Refer to chart at end of section.
3HA5	Refer to chart at end of section. For replacement use type 3HM5/3HA5.
3HM5/3HA5	Refer to type 6HM5/6HA5.
3HQ5	Refer to type 6HQ5.
3HS8	Refer to chart at end of section.
3JC6	Refer to chart at end of section.
3JC6A	Refer to type 6JC6A.
3JD6	Refer to type 6JD6.
3KT6	Refer to type 6KT6.
3LF4	Refer to chart at end of section.
3Q4	Refer to chart at end of section.
3Q5GT	Refer to chart at end of section.
3S4	Refer to chart at end of section.
3V4	Refer to chart at end of section.
4AU6	Refer to type 6AU6A.
4AV6	Refer to type 6AV6.
4BC5	Refer to chart at end of section.
4BC8	Refer to type 6BC8.
4BL8	Refer to chart at end of section.
4BL8/XCF80	Refer to type 6BL8/ECF80.
4BN6	Refer to type 6BN6.
4BQ7A	For replacement use type 4BQ7A/4BZ7.

Refer to type 6BQ7A/6BZ7/6BS8.	4BQ7A/4BZ7
Refer to chart at end of section.	4BS8
Refer to chart at end of section.	4BU8
Refer to type 6BU8.	4BU8/4GS8
Refer to type 6BZ6.	4BZ6
Refer to chart at end of section. For replacement use type 4BQ7A/4BZ7.	4BZ7
Refer to type 6CB6A.	4CB6
Refer to type 6CS6.	4CS6
Refer to chart at end of section.	4CY5
Refer to type 6DE6.	4DE6
Refer to type 6DK6.	4DK6
Refer to chart at end of section.	4DT6
Refer to type 6DT6A.	4DT6A
Refer to chart at end of section.	4EH7
Refer to type 6EH7/EF183.	4EH7/LF183
Refer to chart at end of section.	4EJ7
Refer to type 6EJ7/EF184.	4EJ7/LF184
Refer to chart at end of section.	4ES8
Refer to chart at end of section. For replacement use type 4KN8.	4ES8/XCC189
Refer to chart at end of section. For replacement use type 4LU6.	4EW6
Refer to type 6GK5.	4GK5
Refer to type 6GJ7/ECF801.	4GJ7/XCF801
Refer to chart at end of section.	4GM6
Refer to chart at end of section. For replacement use type 4BU8/4GS8.	4GS8
Refer to chart at end of section.	4GS8/4BU8
Refer to chart at end of section.	4GX7
Refer to chart at end of section.	4GZ5
Refer to chart at end of section. For replacement use type 4HM5/4HA5.	4HA5
Refer to chart at end of section. For replacement use type 4HM5/4HA5.	4HA5/PC900
Refer to chart at end of section.	4HA7

4HA7/4HC7	Refer to chart at end of section.
4HC7	Refer to chart at end of section.
4HM5/4HA5	Refer to type 6HM5/6HA5.
4HM6	Refer to chart at end of section.
4HQ5	Refer to type 6HQ5.
4HS8	Refer to type 6HS8.
4HT6	Refer to chart at end of section.
4JC6	Refer to chart at end of section.
4JC6A	Refer to type 6JC6A.
4JD6	Refer to type 6JD6.
4JH6	Refer to type 6JH6.
4KE8	Refer to type 6KE8.
4KN8/4RHH8	Refer to chart at end of section.
4KT6	Refer to type 6KT6.
4LJ8	Refer to type 6LJ8.
4LU6	Refer to chart at end of section.
4MK8	Refer to type 6MK8A.
4RHH2	For replacement use type 4BQ7A/4BZ7
4RHH8	For replacement use type 4KN8/4RHH8.
5AM8	Refer to type 6AM8A.
5AN8	Refer to type 6AN8A.
5AQ5	Refer to type 6AQ5A.

5AR4/ GZ34

FULL-WAVE VACUUM RECTIFIER

Glass octal type used in power supply of television receivers and other equipment having high dc requirements. Outlines section, 13F; requires octal socket. It is especially important that this tube, like other power-handling tubes, be adequately ventilated. Heater: volts (ac/dc), 5; amperes, 1.9.

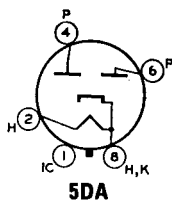

Full-Wave Rectifier

MAXIMUM RATINGS (Design-Maximum Values)

Peak Inverse Plate Voltage	7100	volts
Peak Plate Current (Per Plate)	825	mA
Hot-Switching Transient Plate Current (Per Plate)	3.7	amperes
AC Plate-Supply Voltage (Per Plate, rms, without load)	See Rating Chart	
Average Output Current (Per Plate)	See Rating Chart	

TYPICAL OPERATION WITH CAPACITOR INPUT TO FILTER

AC Plate-to-Plate Supply Voltage (rms)	450	550	volts
Effective Plate-Supply Impedance per Plate	160	200	ohms
Average Output Current	225	160	mA
DC Output Voltage at Input to Filter	475	620	volts

TYPICAL OPERATION WITH CHOKE INPUT TO FILTER

AC Plate-to-Plate Supply Voltage (rms)	450	550	volts
Filter Input Choke	10	10	henries
Average Output Current	250	225	mA
DC Output Voltage at Input to Filter	375	465	volts

CHARACTERISTIC, Instantaneous Value

Tube Voltage Drop for plate current of 225 mA (Per Plate)	—	17	volts
--------------------------------------------------------------------	---	----	-------

RATING CHART

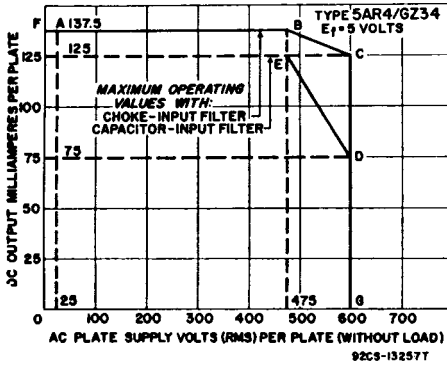

Refer to chart at end of section.

5A54

FULL-WAVE VACUUM RECTIFIER

5A54A

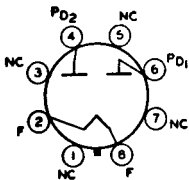

5T

Glass octal type used in power supplies of television receivers having high dc requirements. Outlines section, 19D; requires octal socket. This type may be supplied with pins 3, 5, and 7 omitted. Vertical mounting is preferred, but horizontal mounting is permissible if pins 2 and 4 are in vertical plane. It is especially important that this tube, like other power-handling tubes, be adequately ventilated. Heater: volts (ac), 5; amperes, 3. For maximum ratings, typical operation, and curves, refer to type 5U4GB.

Refer to chart at end of section.

5A58

Refer to type 6AT8A.

5AT8

Refer to chart at end of section.

5AU4

For replacement use type 5V3A/5AU4.

Refer to chart at end of section.

5AV8

Refer to chart at end of section.

5AW4

Refer to chart at end of section.

5AZ4

Refer to chart at end of section.

5B8

Refer to chart at end of section.

5BC3

5BC3A

FULL-WAVE VACUUM RECTIFIER

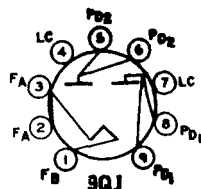

Novar types used in power supplies of radio equipment and television receivers having high dc requirements. Outlines section, 31C; requires novar 9-contact socket. Vertical operation is preferred, but tubes may be operated in horizontal position if pins 2 and 7 are in vertical plane. It is especially important that these tubes, like other power-handling tubes, be adequately ventilated. Filament: volts (ac), 5; amperes, 3.

Full-Wave Rectifier

MAXIMUM RATINGS (Design-Maximum Values)

Peak Inverse Plate Voltage	1700	volts
Peak Plate Current (Per Plate)	1	ampere
Hot-Switching Transient Plate Current (Per Plate)*	5	amperes
AC Plate-Supply Voltage (Per Plate, rms)	See Rating Chart	
Average Output Current (Per Plate)	See Rating Chart	

TYPICAL OPERATION WITH CAPACITOR INPUT TO FILTER

AC Plate-to-Plate Supply Voltage (rms)	600	900	1100	volts
Filter-Input Capacitor*	40	40	40	μ F
Total Effective Plate-Supply Impedance per Plate	21	67	97	ohms
DC Output Voltage at Input to Filter (Approx.):				
At load current of: 300 mA	290	—	—	volts
275 mA	—	460	—	volts
162 mA	—	—	630	volts
160 mA	335	—	—	volts
137.5 mA	—	520	—	volts
81 mA	—	—	680	volts

TYPICAL OPERATION WITH CHOKE INPUT TO FILTER

AC Plate-to-Plate Supply Voltage (rms)	900	1100	volts
Filter-Input Choke	10	10	henries
DC Output Voltage at Input to Filter (Approx.):			
At load current of: 348 mA	340	—	volts
275 mA	—	440	volts
174 mA	355	—	volts
137.5 mA	—	445	volts

* If hot switching is regularly required in operation, the use of choke-input circuits is recommended. Such circuits limit the hot-switching current to a value no higher than that of the peak plate current. When capacitor-input circuits are used, a maximum peak current value per plate of 5 amperes during the initial cycles of the hot-switching transient should not be exceeded.

• Higher values of capacitance than indicated may be used, but the effective plate-supply impedance may have to be increased to prevent exceeding the maximum rating for peak plate current.

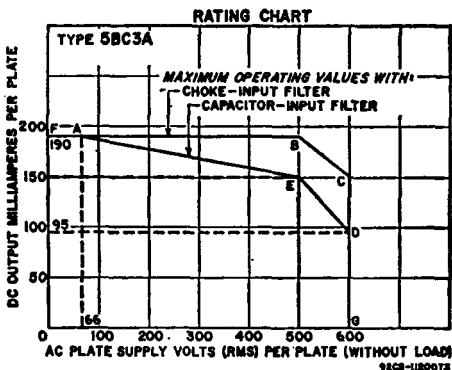

Refer to chart at end of section.	5BE8
Refer to type 6BK7B.	5BK7A
Refer to type 6BQ7A.	5BQ7A
For replacement use type 5BR8/5FV8.	5BR8
Refer to type 6BR8A.	5BR8/5FV8
Refer to chart at end of section.	5BT8
Refer to chart at end of section.	5BW8
Refer to type 6CG8A.	5CG8
Refer to chart at end of section.	5CL8
Refer to type 6CL8A.	5CL8A
Refer to chart at end of section.	5CM8
Refer to chart at end of section.	5CQ8
Refer to type 6CZ5.	5CZ5
Refer to chart at end of section.	5DH8
Refer to chart at end of section.	5DJ4
Refer to type 6EA8.	5EA8
Refer to chart at end of section.	5ES8
Refer to chart at end of section.	5ES8/YCC189
Refer to chart at end of section.	5EU8
Refer to type 6EW6.	5EW6
Refer to type 6FG7.	5FG7
Refer to chart at end of section.	5FV8
For replacement use type 5BR8/5FV8.	5FV8
Refer to type 6GH8A.	5GH8A
Refer to chart at end of section.	5GJ7
Refer to 6GJ7/ECF801.	5GJ7/LCF801
Refer to type 6GM6.	5GM6
Refer to type 6GS7.	5GS7
Refer to chart at end of section.	5GX6
For replacement use type 5HZ6.	5GX6
Refer to chart at end of section.	5GX7
Refer to chart at end of section.	5HA7
Refer to type 6HB7.	5HB7

5HG8

Refer to chart at end of section.

5HG8/LCF86

Refer to type 6HG8/ECF86.

5HZ6

Refer to type 6HZ6.

5J6

Refer to type 6J6A.

5JK6

Refer to chart at end of section.

5JL6

Refer to chart at end of section.

5JW8

Refer to type 6JW8/ECF802.

5KD8

**MEDIUM-MU TRIODE—
SHARP-CUTOFF PENTODE**

Miniature type used as combined vhf oscillator and mixer tube in television receivers. Outlines section, 6B; requires miniature 9-contact socket.

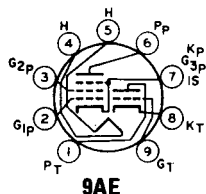

Heater Voltage (ac/dc)	5.6	volts
Heater Current	0.45	ampere
Heater Warm-up Time	11	seconds
Heater-Cathode Voltage:		
Peak value	±200 max	volts
Average value	100 max	volts

Class A₁ Amplifier

MAXIMUM RATINGS (Design-Maximum Values)	Triode Unit	Pentode Unit	
Plate Voltage	330	330	volts
Grid-No.2 (Screen-Grid) Supply Voltage	—	330	volts
Grid-No.2 Voltage	—	See curve page 300	volts
Grid-No.1 (Control-Grid) Voltage, Positive-bias value	0	0	volts
Plate Dissipation	2.5	3	watts
Grid-No.2 Input:			
For grid-No.2 voltages up to 165 volts	—	0.55	watt
For grid-No.2 voltages between 165 and 330 volts	—	See curve page 300	
CHARACTERISTICS			
Plate Voltage	125	125	volts
Grid-No.2 Voltage	—	110	volts
Grid-No.1 Voltage	—1	—1	volt
Amplification Factor	40	—	
Plate Resistance (Approx.)	—	0.2	megohm
Transconductance	7500	5000	μmhos
Plate Current	13.5	9.5	mA
Grid-No.2 Current	—	3.5	mA
Grid-No.1 Voltage (Approx.) for plate current of 20 μA	—9	—8	volts
MAXIMUM CIRCUIT VALUES			
Grid-No.1-Circuit Resistance:			
For fixed-bias operation		0.5	megohm
For cathode-bias operation		1	megohm

5KE8

Refer to type 6KE8.

5KZ8

Refer to type 6KZ8.

Refer to type 6LJ8.

5LJ8

Refer to type 6MB8.

5MB8

For replacement use type 5J6.

5MHH3

Refer to type 6MQ8.

5MQ8

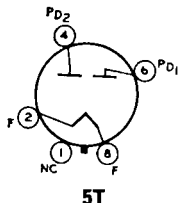

**FULL-WAVE
VACUUM RECTIFIER**

**5R4GB
INDUSTRIAL
TYPE**

Glass octal type for industrial and military applications. Outlines section, 19D; requires octal socket.

Filament Voltage (ac/dc)	5	volts
Filament Current	2	amperes
Operating Position	Vertical, base down or up, or Horizontal with pins 2 and 4 in vertical plane	

Full-Wave Rectifier

MAXIMUM RATINGS (Absolute-Maximum Values)

For altitudes up to	40000	20000	feet
Peak Inverse Plate Voltage	2650	3100	volts
AC Plate Supply Voltage Per Plate (RMS, without load)	See Rating Chart		
Peak Plate Current Per Plate	715	715	mA
DC Output Current Per Plate	See Rating Chart		
Hot-Switching Transient Plate Current Per Plate	* See Rating Chart *		
Bulb Temperature (At hottest point on bulb surface)	230	230	°C

TYPICAL OPERATION (With Capacitor-Input Filter)

For altitudes up to	40000		20000	feet
AC-Plate-to-Plate Supply Voltage (RMS, without load)	1400	1500	2000	volts
Filter-Input Capacitor	20	20	20	μF
Total Effective Plate Supply Impedance Per Plate**	225	250	375	ohms
DC Output Voltage at Input to Filter (approx.):				
At half-load current of	{ 75 mA	910	1210	volts
	{ 125 mA	750	—	volts
	{ 150 mA	—	800	1040
	{ 250 mA	605	—	volts
Voltage Regulation (approx.):				
Half-load to full-load current	145	110	170	volts
DC Output Current	250	150	150	mA

TYPICAL OPERATION (With Choke-Input Filter)

For altitudes up to	40000	20000	feet
AC Plate-to-Plate Supply Voltage (RMS, without load)	1500	1900	volts
Filter-Input Choke	5	10	henries
DC Output Voltage at Input to Filter for dc output (approx.):			
87.5 mA	—	800	volts
125 mA	600	—	volts
175 mA	—	760	volts
250 mA	560	—	volts
Voltage Regulation (Approx.):			
Half-load to full-load current	40	40	volts
DC Output Current	250	175	mA

* If hot-switching is required in operation, choke-input circuits are recommended. Such circuits limit the hot-switching current to a value no higher than that of the peak plate current. When capacitor-input circuits are used, a maximum value of 3 amperes should not be exceeded.

** Indicated values for conditions shown will limit peak plate current to the maximum-rated value. When a filter-input capacitor larger than 20 μf is used, it may be necessary to increase plate-supply impedance to a higher value than that shown in the data to limit the peak plate current to the maximum-rated value.

RATING CHART

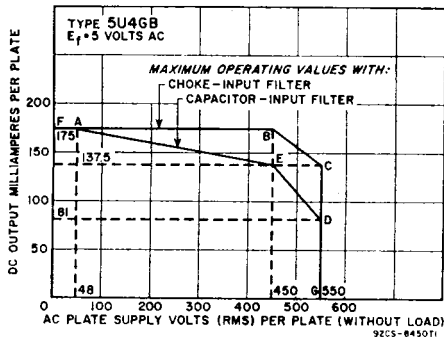

TYPICAL OPERATION WITH CHOKE INPUT TO FILTER

AC Plate-to-Plate Supply Voltage (rms)	900	1100	volts
Filter-Input Choke	10	10	henries
DC Output Voltage at Input to Filter (Approx.):			
At half-load current of	{ 174 mA	355	volts
	{ 137.5 mA	—	volts
At full-load current of	{ 348 mA	340	volts
	{ 275 mA	—	volts
Voltage Regulation (Approx.):			
Half-load to full-load current	15	15	volts

If hot switching is regularly required in operation, the use of choke-input circuits is recommended. Such circuits limit the hot-switching current to a value no higher than that of the peak plate current. When capacitor-input circuits are used, a maximum peak current value per plate of 4.6 amperes during the initial cycles of the hot-switching transient should not be exceeded.

* Higher values of capacitance than indicated may be used, but the effective plate-supply impedance may have to be increased to prevent exceeding the maximum rating for peak plate current.

OPERATION CHARACTERISTICS
FULL-WAVE CIRCUIT, CHOKE INPUT TO FILTER

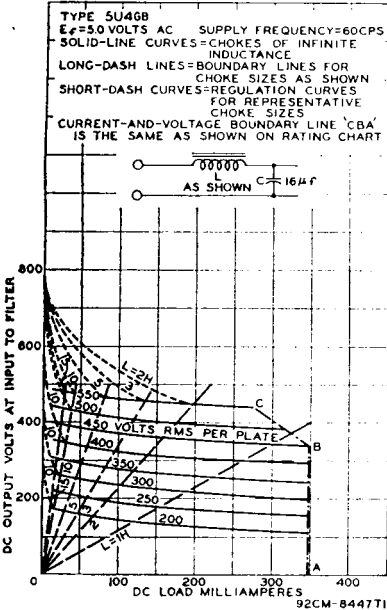

OPERATION CHARACTERISTICS
FULL-WAVE CIRCUIT, CAPACITOR INPUT TO FILTER

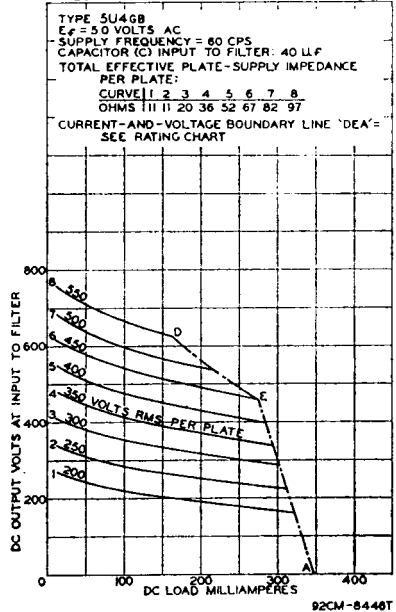

5U8

Refer to type 6U8A.

5U9/LCF201

Refer to chart at end of section.

5V3Refer to chart at end of section.
For replacement use type 5V3A/5AU4.**5V3A**

For replacement use type 5V3A/5AU4.

5V3A/5AU4**FULL-WAVE
VACUUM RECTIFIER**

Glass octal type used in power supplies of color and black-and-white television receivers and other equipment having high dc requirements. Outlines section, 19E; requires octal socket. Vertical mounting is preferred, but horizontal mounting is permissible if pins 2 and 4 are in vertical plane. It is especially important that this tube, like other power-handling tubes, be adequately ventilated. For discussion of Rating Chart, refer to Interpretation of Tube Data. Filament: volts (ac/dc), 5; amperes, 3.

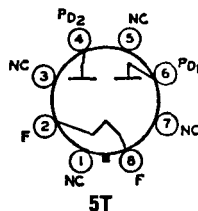
**Full-Wave Rectifier****MAXIMUM RATINGS (Design-Maximum Values)**

Peak Inverse Plate Voltage	1550	volts
Peak Plate Current (Per Plate)	1.4	amperes
Hot-Switching Transient Plate Current (Per Plate)	6.6	amperes
AC Plate-Supply Voltage (Per Plate, rms, without load)	550	volts
Average Output Current (Per Plate)	415°	mA

* With capacitor-input filter for ac plate-supply volts (rms, per plate, without load) = 470.

TYPICAL OPERATION

Filter Input	Capacitor	Choke	
AC Plate-to-Plate Supply Voltage (rms)	850	1000	volts
Filter-Input Capacitor*	40	—	μF
Effective Plate-Supply Impedance per Plate	50	—	ohms
Minimum Filter-Input Choke	—	10	henries
Average Output Current	350	350	mA
DC Output at Input to Filter (Approx.)	440	390	volts

CHARACTERISTIC

Tube Voltage Drop for plate current of 350 mA (per plate) 42 volts

* When capacitor values greater than 40 μF are used, the effective plate-supply impedance should be increased so that the maximum rating for peak plate current is not exceeded.

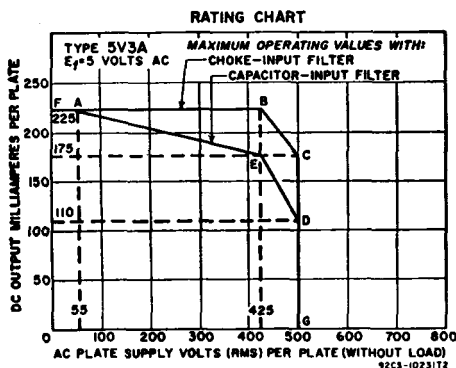
**5V4G**

Refer to chart at end of section.

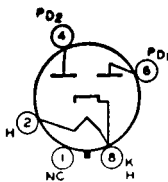

5L

**FULL-WAVE
VACUUM RECTIFIER**

5V4GA

Glass octal type used in full-wave power supplies having high dc requirements. Outlines section, 19B; requires octal socket. The heater is designed to operate from the ac line through a step-down transformer. The voltage at the heater terminals should be 5 volts under operating conditions at an average line voltage of 117 volts. It is especially important that these tubes, like other power-handling tubes, be adequately ventilated. Heater: volts (ac/dc) 5; amperes, 2.

Full-Wave Rectifier

MAXIMUM RATINGS (Design-Center Values)

Peak Inverse Plate Voltage	1400	volts
AC Plate-Supply Voltage (Per Plate, rms):		
With capacitor-input filter	375	volts
With choke-input filter	500	volts
Peak Plate Current (Per Plate)	525	mA
Average Output Current	175	mA

TYPICAL OPERATION

	Filter Input	Capacitor	Choke	
AC Plate-to-Plate Supply Voltage (rms)	750	1000	1000	volts
Filter-Input Capacitor*	10	—	—	μF
Total Effective Plate-Supply Impedance per Plate ..	100	—	—	ohms
Filter-Input Choke	—	—	4	henries
DC Output Voltage at Input to Filter (Approx.):				
At output current of 175 mA	410	410	410	volts

* Higher values of capacitance than indicated may be used, but the effective plate-supply impedance may have to be increased to prevent exceeding the maximum rating for peak plate current.

**OPERATION CHARACTERISTICS
FULL-WAVE RECTIFIER CIRCUIT**

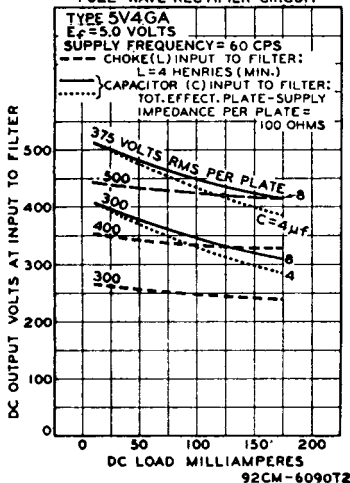

Refer to chart at end of section.

5V6GT

Refer to chart at end of section.

**5W4
5W4GT**

Refer to chart at end of section.

5X4G

5X8

Refer to type 6X8A.

5Y3G
5Y3GA

For replacement use type 5Y3GT.

5Y3GT

FULL-WAVE VACUUM RECTIFIER

Glass octal type used in power supplies of radio and television equipment having moderate dc requirements. Outlines section, 13E; requires octal socket. Vertical mounting is preferred, but horizontal mounting is permissible if pins 2 and 8 are in horizontal plane. It is especially important that this tube, like other power-handling tubes, be adequately ventilated. For discussion of Rating Chart and Operating Characteristics, refer to Interpretation of Tube Data. Filament: volts (ac), 5; amperes, 2.

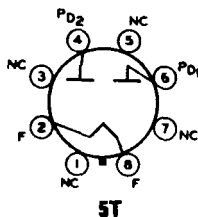

Full-Wave Rectifier

MAXIMUM RATINGS (Design-Center Values)

Peak Inverse Plate Voltage	1400	volts
Peak Plate Current (Per Plate)	440	mA
Hot-Switching Transient Plate Current (Per Plate)	2.5	amperes
AC Plate Supply Voltage (Per Plate, rms)	See Rating Chart	
DC Output Current (Per Plate)	See Rating Chart	

TYPICAL OPERATION WITH CAPACITOR INPUT TO FILTER

AC Plate-to-Plate Supply Voltage (rms)	700	1000	volts	
Filter Input Capacitor*	20	10	μ F	
Effective Plate-Supply Impedance per Plate	50	140	ohms	
DC Output Voltage at Input to Filter (Approx.):				
At half-load current of	62.5 mA	390	volts	
	42 mA	—	610	volts
	125 mA	360	volts	
At full-load current of	84 mA	—	560	volts
Voltage Regulation (Approx.):				
Half-load to full-load current	40	50	volts	

TYPICAL OPERATION WITH CHOKE INPUT TO FILTER

AC Plate-to-Plate Supply Voltage (rms)	700	1000	volts	
Filter Input Choke#	10	10	henries	
DC Output Voltage at Input to Filter (Approx.):				
At half-load current of	75 mA	270	volts	
	62.5 mA	—	405	volts
	150 mA	245	volts	
	125 mA	—	380	volts
Voltage Regulation (Approx.):				
Half-load to full-load current	25	15	volts	

RATING CHART

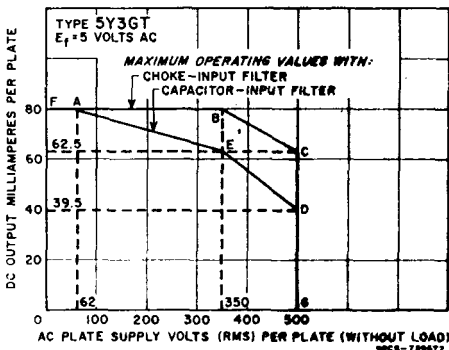

* Higher values of capacitance than indicated may be used but the effective plate supply impedance may have to be increased to prevent exceeding the maximum rating for hot-switching transient plate current.

This value is adequate to maintain optimum regulation in the region to the right of line L = 10H on curve OPERATION CHARACTERISTICS with Choke Input to Filter, provided the load currents are not less than 35 mA and 50 mA, respectively, for plate-to-plate supply voltages of 700 and 1000 volts (rms).

OPERATION CHARACTERISTICS

FULL-WAVE CIRCUIT, CAPACITOR INPUT TO FILTER

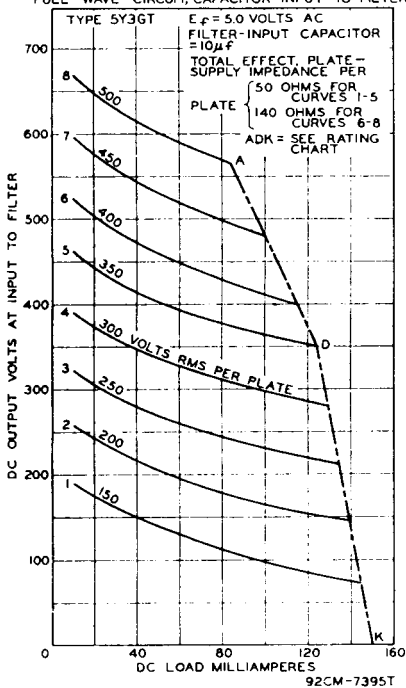

OPERATION CHARACTERISTICS

FULL-WAVE CIRCUIT, CHOKE INPUT TO FILTER

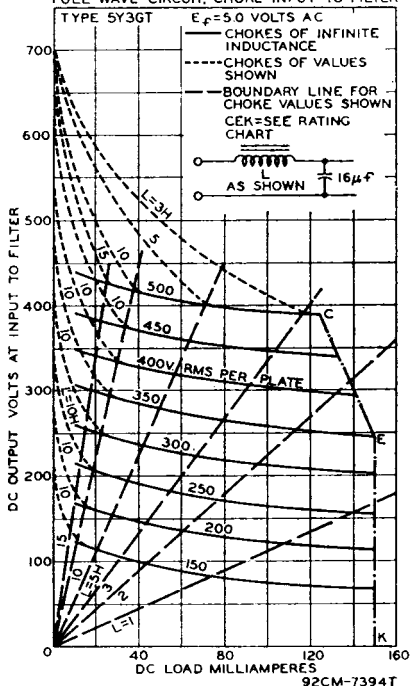

Refer to chart at end of section.

5Y4G

Refer to chart at end of section.

**5Y4GA
 5Y4GT**

Refer to chart at end of section.

5Z3

Refer to chart at end of section.
 For replacement use type 5Y3GT.

5Z4

Refer to chart at end of section.

6A3

Refer to chart at end of section.

6A6

Refer to chart at end of section.

6A7

Refer to chart at end of section.

6A7S

Refer to chart at end of section.

6A8

Refer to chart at end of section.

**6A8G
 6A8GT**

6AB4**HIGH-MU TRIODE**

Miniature type used as cathode-drive amplifier, frequency converter, or oscillator at frequencies up to 300 MHz in television and FM receivers. **Outlines section, 5C**; requires miniature 7-contact socket. **Heater:** volts (ac/dc), 6.3; amperes, 0.15. For operation as resistance-coupled amplifier, refer to **Resistance-Coupled Amplifier** section. For maximum ratings, characteristics, and curves refer to type 12AT7.

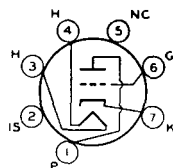
**5CE****6AB5/6N5**

Refer to chart at end of section.

6AB7

Refer to chart at end of section.

6AC5GT

Refer to chart at end of section.

6AC7

Refer to chart at end of section.

6AC7W

Refer to chart at end of section.

6AC10**8AC10, 12AC10A****HIGH-MU TRIPLE TRIODE**

Duodecar type used in matrixing (color-difference) circuits of color television receivers. **Outlines section, 8B**; requires duodecar 12-contact socket. Types 8AC10 and 12AC10A are identical with type 6AC10 except for heater ratings.

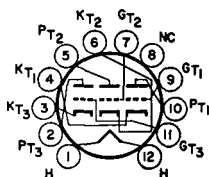
**12FE**

	6AC10	8AC10	12AC10A	
Heater Voltage (ac/dc)	6.3	8.4	12.5	volts
Heater Current	0.6	0.45	0.3	ampere
Heater Warm-up Time (Average)	11	11	11	seconds
Heater-Cathode Voltage:				
Peak value	±200 max	±200 max	±200 max	volts
Average value	100 max	100 max	100 max	volts

Class A₁ Amplifier**MAXIMUM RATINGS (Design-Maximum Values)**

Plate Voltage	330	volts
Plate Dissipation	2	watts

CHARACTERISTICS

Plate Voltage	200	volts
Cathode-Bias Resistor	150	ohms
Amplification Factor	62	
Plate Resistance (Approx.)	10700	ohms
Transconductance	5800	μmhos
Plate Current	9	mA
Grid Voltage (approx.) for plate current of 100 μA	-5	volts

MAXIMUM CIRCUIT VALUE

Grid-Circuit Resistance	0.5	megohm
-------------------------	-----	--------

6AD6G

Refer to chart at end of section.

6AD7G

Refer to chart at end of section.

6AD10**BEAM POWER TUBE—
SHARP-CUTOFF PENTODE**

Duodecar type used as FM detector and audio-frequency output amplifier in color and black-and-white television receivers. **Outlines section, 8B**; requires duodecar 12-contact socket.

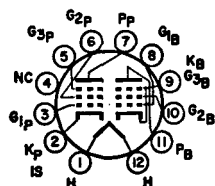
**12EZ**

Heater Voltage (ac/dc)	6.3	volts
Heater Current	1.05	amperes
Heater-Cathode Voltage:		
Peak value	±200 max	volts
Average value	100 max	volts
Direct Interelectrode Capacitances:		
Beam Power Unit:		
Grid No.1 to Plate	0.26	pF
Grid No.1 to Cathode, Heater, Grid No.2, Grid No.3, and Internal Shield	11	pF
Plate to Cathode, Heater, Grid No.2, Grid No.3, and Internal Shield	11	pF
Pentode Unit:		
Grid No.1 to Plate	0.024	pF
Grid No.3 to Plate	3.4	pF
Grid No.1 to Cathode, Heater, Grid No.2, Grid No.3, and Internal Shield	8	pF
Grid No.3 to Cathode, Heater, Grid No.1, Grid No.2, Plate, and Internal Shield	9.5	pF
Grid No.1 to Grid No.3	0.12	pF
Plate of Beam Power Unit to Plate of Pentode Unit	0.34	pF

Beam Power Unit as Class A₁ Amplifier

MAXIMUM RATINGS (Design-Maximum Values)

Plate Voltage	275	volts
Grid-No.2 (Screen-Grid) Voltage	275	volts
Plate Dissipation	10	watts
Grid-No.2 Input	2	watts

TYPICAL OPERATION

Plate Voltage	250	volts
Grid-No.2 Voltage	250	volts
Grid-No.1 (Control-Grid) Voltage	-8	volts
Peak AF Grid-No.1 Voltage	8	volts
Zero-Signal Plate Current	35	mA
Maximum-Signal Plate Current	39	mA
Zero-Signal Grid-No.2 Current	2.5	mA
Maximum-Signal Grid-No.2 Current	7	mA
Plate Resistance (Approx.)	0.1	megohm
Transconductance	6500	μmhos
Load Resistance	5000	ohms
Total Harmonic Distortion	10	per cent
Maximum-Signal Power Output	4.2	watts

MAXIMUM CIRCUIT VALUES

Grid-No.1-Circuit Resistance:		
For fixed-bias operation	0.25	megohm
For cathode-bias operation	0.5	megohm

Pentode Unit as Class A₁ Amplifier

CHARACTERISTICS

Plate Supply Voltage	150	volts
Grid No.3 (Control Grid)	Connected to negative end of cathode resistor	
Grid-No.2 (Screen-Grid) Voltage	100	volts
Grid No.1 (Control Grid)	Connected to negative end of cathode resistor	
Cathode-Bias Resistor	180	ohms
Plate Resistance (Approx.)	0.11	megohm
Transconductance, Grid No.1 to Plate	3400	μmhos
Transconductance, Grid No.3 to Plate	600	μmhos
Plate Current	3.2	mA
Grid-No.2 Current	3.2	mA
Grid-No.1 Voltage (Approx.) for plate current of 20 μA	-4.5	volts
Grid-No.3 Voltage (Approx.) for plate current of 20 μA	-7	volts

Pentode Unit as FM Sound Detector

MAXIMUM RATINGS (Design-Maximum Values)

Plate Voltage	300	volts
Grid-No.3 Voltage:		
Negative-bias value	100	volts
Positive-bias value	25	volts
Grid-No.2 Supply Voltage	300	volts
Grid-No.2 Voltage		
Grid-No.1 Voltage:	See curve page 300	
Negative-bias value	-50	volts
Positive-bias value	0	volts
Plate Dissipation	1.7	watts
Grid-No.3 Input	0.1	watt
Grid-No.2 Input:		
For grid-No.2 voltages up to 150 volts	1	watt
For grid-No.2 voltages between 150 and 300 volts	See curve page 300	

MAXIMUM CIRCUIT VALUES

Grid-No.3-Circuit Resistance	0.68	megohm
Grid-No.1-Circuit Resistance:		
For fixed-bias operation	0.22	megohm
For cathode-bias operation	0.47	megohm

6AE5GT Refer to chart at end of section.

6AE6G Refer to chart at end of section.

6AE7GT Refer to chart at end of section.

6AF3

12AF3,
12AF3/12BR3/12RK19

Miniature type used as a damper tube in horizontal-deflection circuits of television receivers. Outlines section, 7C; requires miniature 9-contact socket. Socket terminals 1, 2, 3, 6, 7, and 8 should not be used as tie points. It is especially important that this tube, like other power-handling tubes, be adequately ventilated. Types 12AF3 and 12AF3/12BR3/12RK19 are identical with type 6AF3 except for heater ratings.

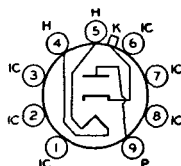
**HALF-WAVE
VACUUM RECTIFIER****9CB**

	6AF3	12AF3 12AF3/12BR3/ 12RK19	
Heater Voltage (ac/dc)	6.3	12.6	volts
Heater Current	1.2	0.6	amperes
Heater Warm-up Time (Average)	—	11	seconds

Damper Service

For operation in a 525-line, 30-frame system

MAXIMUM RATINGS (Design-Maximum Values)

Peak Inverse Plate Voltage#	4500	volts	
Peak Plate Current	750	mA	
Average Plate Current	185	mA	
Bulb Temperature (At hottest point)	210	°C	
Heater-Cathode Voltage:			
Peak value	+300	—4500	volts
Average value	+100	—1000	volts

Pulse duration must not exceed 15% of a horizontal scanning cycle (10 microseconds).

6AF4**6AF4A**

2AF4B/2DZ4,
3AF4A/3DZ4

Miniature types used as local oscillators in uhf television receivers covering the frequency range of 470 to 890 MHz. Outlines section, 5C and 5B, respectively; requires miniature 7-contact socket. Types 2AF4B/2DZ4 and 3AF4A/3DZ4 are identical with type 6AF4A except for heater and heater-cathode ratings.

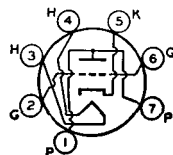
MEDIUM-MU TRIODE**7DK**

	2AF4B/ 2DZ4	3AF4A/ 3DZ4	6AF4 6AF4A	
Heater Voltage (ac/dc)	2.35	3.15	6.3	volts
Heater Current	0.6	0.45	0.225	ampere
Heater Warm-up Time (Average)	11	11	—	seconds
Heater-Cathode Voltage:				
Peak value	±180 max	±50 max	±50 max	volts
Average value	100 max	25 max	25 max	volts
Direct Interelectrode Capacitances:*				
Grid to Plate			1.9	pF
Grid to Cathode and Heater			2.2	pF
Plate to Cathode and Heater			1.4	pF
Heater to Cathode (External Shield connected to plate)			2.2	pF

* With external shield connected to cathode, except as noted.

Class A₁ Amplifier

CHARACTERISTICS

Plate Supply Voltage	80	volts
Cathode-Bias Resistor	150	ohms
Amplification Factor	13.5	
Plate Resistance (Approx.)	2100	ohms
Transconductance	6500	μ mhos
Plate Current	17.5	mA

UHF Oscillator

MAXIMUM RATINGS (Design-Maximum Values)

Plate Voltage	150	volts
Grid Voltage, Negative-bias value	50	volts
Grid Current	2	mA
Plate Dissipation	2.5	watts
Average Cathode Current	24	mA

TYPICAL OPERATION AS OSCILLATOR AT 1000 MHz

Plate Supply Voltage	100	volts
Plate Resistor	220	ohms
Grid Resistor	10000	ohms
Plate Current	17	mA
Grid Current (Approx.)	750	μ A

MAXIMUM CIRCUIT VALUES

Grid-Circuit Resistance:		
For fixed-bias operation		Not recommended
For cathode-bias operation	0.5	megohm

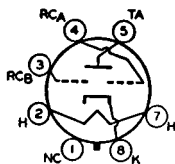
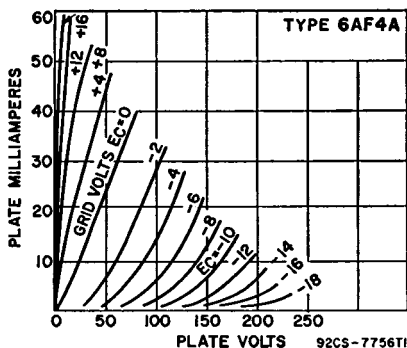

7AG

ELECTRON-RAY TUBE

6AF6G

Glass octal type used to indicate visually, by means of two shadows on the fluorescent target, the effects of changes in the controlling voltages. It is a twin-indicator type and is used as a convenient means of indicating accurate radio-receiver tuning. This type may be supplied with pin No. 1 omitted. Tube requires octal

socket. Heater: volts (ac/dc), 6.3; amperes, 0.15. Maximum ratings in indicator service: fluorescent-target volts, 250 max, 125 min; ray-control-electrode supply volts, 250 max; peak heater-cathode volts, 90 max. Typical operation: fluorescent-target volts, 250; fluorescent-target mA, 3.75; ray-contact-electrode volts (approx. for 0° shadow angle), 155; ray-control-electrode volts (approx. for 100° shadow angle), 0.

6AF9**DUAL PENTODE**

11AF9

Miniature type used in television receiver applications. Unit No.1 is used as a video output pentode, and unit No.2 as a sound if amplifier, agc amplifier, or sync separator. Outlines section, 6L, except has 10-pin base; requires miniature 10-contact socket. Type 11AF9 is identical with type 6AF9 except for heater ratings.

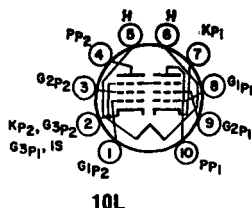

	6AF9	11AF9	
Heater Voltage (ac/dc)	6.3	11.5	volts
Heater Current	0.85	0.45	amperes
Peak Heater-Cathode Voltage	±200 max	±200 max	volts

Direct Interelectrode Capacitances:

	Unit No.1	Unit No.2	
Plate to All Other Electrodes (except grid No.1)	7	11	pF
Grid No.1 to All Other Electrodes (except plate)	12	10	pF
Plate to Grid No.1	0.105	0.140	pF
Grid No.1 to Heater	—	0.140	pF
Plate of Unit No.1 to Plate of Unit No. 2		0.150 max	pF
Grid No.1 of Unit No.1 to Grid No.1 of Unit No. 2		0.010 max	pF
Plate of Unit No.1 to Grid No.1 of Unit No.2		0.100 max	pF
Plate of Unit No.2 to Grid No.1 of Unit No.1		0.005 max	pF

Class A₁ Amplifier**MAXIMUM RATINGS (Design-Maximum Values)**

	Unit No.1	Unit No.2	
Plate Supply Voltage	550	550	volts
Plate Voltage	250	250	volts
Grid-No.2 (Screen-Grid) Supply Voltage	550	550	volts
Grid-No.2 Voltage	250	250	volts
Cathode Current	60	15	mA
Plate Dissipation	5.1	1.5	watts
Grid-No.2 Input	2.5	0.5	watts

CHARACTERISTICS

Plate Voltage	170	150	volts
Grid-No.2 Voltage	170	150	volts
Grid-No.1 (Control-Grid) Voltage	-2.6	-2.1	volts
Mu Factor, Grid No.1 to Grid No.2	38	38	
Internal Resistance	0.032	0.16	megohm
Transconductance	22000	8500	μmhos
Plate Current	30	10	mA
Grid-No.2 Current	7.2	3	mA

MAXIMUM CIRCUIT VALUES

Grid-No.1-Circuit Resistance	1	1	megohm
------------------------------------	---	---	--------

6AF11**DUAL TRIODE—
SHARP-CUTOFF PENTODE**

15AF11

Duodecar type used in television receiver applications. The high-mu triode unit is used for agc keyer service, the medium-mu triode unit for sync separator service, and the pentode unit for video amplifier service. Outlines section, 8C; requires duodecar 12-contact socket. Type 15AF11 is identical with type 6AF11 except for heater ratings.

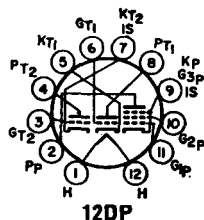

	6AF11	15AF11	
Heater Voltage (ac/dc)	6.3	14.7	volts
Heater Current	1.05	0.45	amperes
Heater Warm-up Time (Average)	—	11	seconds
Heater-Cathode Voltage:			
Peak value	±200 max	±200 max	volts
Average value	100 max	100 max	volts

Class A₁ Amplifier

MAXIMUM RATINGS (Design-Maximum Values)				
	Triode Unit No.1	Triode Unit No.2	Pentode Unit	
Plate Voltage	330	330	330	volts
Grid-No.2 (Screen-Grid) Supply Voltage	—	—	330	volts
Grid-No.2 Voltage	—	—	See curve page 300	
Grid-No.1 (Control-Grid) Voltage, Positive-bias value	0	0	0	volts
Plate Dissipation	1.1	2	5	watts
Grid-No.2 Input:				
For grid-No.2 voltages up to 165 volts	—	—	1.25	watts
For grid-No.2 voltages between 165 and 330 volts	—	—	See curve page 300	

CHARACTERISTICS

Plate Supply Voltage	200	200	250	volts
Grid-No.2 Supply Voltage	—	—	150	volts
Grid-No.1 Voltage	-2	—	—	volts
Cathode-Bias Resistor	—	220	100	ohms
Amplification Factor	68	41	—	
Plate Resistance (Approx.)	12400	9400	68000	ohms
Transconductance	5500	4400	11000	μmhos
Plate Current	7	9.2	24	mA
Grid-No.2 Current	—	—	4.8	mA
Grid-No.1 Voltage (Approx.) for plate current of 100 μA	—	-6.5	-10	volts

MAXIMUM CIRCUIT VALUES

Grid-No.1-Circuit Resistance:				
For fixed-bias operation	0.5	0.5	0.25	megohm
For cathode-bias operation	1	1	1	megohm

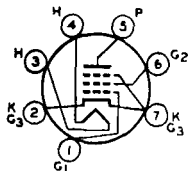

7BD

SHARP-CUTOFF PENTODE

6AG5

Miniature type used in compact radio equipment as an rf or if amplifier up to 400 MHz. Outlines section, 5C; requires miniature 7-contact socket. For typical operation as a resistance-coupled amplifier, refer to Resistance-Coupled Amplifier section.

Heater Voltage (ac/dc)		6.3	volts
Heater Current		0.3	ampere
Direct Interelectrode Capacitances:			
Pentode Unit:			
Grid No.1 to Plate		0.030 max	pF
Grid No.1 to Cathode, Heater, Grid No.2, Grid No.3, and Internal Shield		6.5	pF
Plate to Cathode, Heater, Grid No.2, Grid No.3, and Internal Shield		1.8	pF
Triode Unit:			
Grid No.1 to Plate and Grid No.2		2.5	pF
Grid No.1 to Cathode, Heater, Grid No.3, and Internal Shield		3.6	pF
Grid No.2 to Cathode, Heater, Grid No.3, and Internal Shield		3	pF
Plate to Cathode, Heater, Grid No.3, and Internal Shield		3	pF

Class A₁ Amplifier

MAXIMUM RATINGS (Design-Center Values)					
	Triode Connection*		Pentode Connection		
Plate Voltage	300	300	300	300	volts
Grid-No.2 (Screen-Grid) Supply Voltage	—	—	300	300	volts
Grid-No.2 Voltage	—	—	See curve page 300	See curve page 300	
Grid-No.1 (Control-Grid) Voltage, Positive-bias value	0	0	0	0	volts
Plate Dissipation	2.5	2	2	2	watts
Grid-No.2 Input:					
For grid-No.2 voltages up to 150 volts	—	—	0.5	0.5	watt
For grid No.2 voltages between 150 and 300 volts	—	—	See curve page 300	See curve page 300	

CHARACTERISTICS

Plate Supply Voltage	180	250	100	125	250	volts
Grid-No.2 Supply Voltage	—	—	100	125	150	volts
Cathode-Bias Resistor	330	820	180	100	180	ohms
Amplification Factor	45	42	—	—	—	
Plate Resistance (Approx.)	0.008	0.01	0.6	0.5	0.8	megohm
Transconductance	5700	3800	4500	5100	5000	μmhos
Plate Current	7	5.5	4.5	7.2	6.5	mA

	Triode Connection*		Pentode Connection			
Grid-No.2 Current	—	—	1.4	2.1	2	mA
Grid-No.1 Voltage (Approx.) for plate current of 10 μ A	—	—	—5	—6	—8	volts

* Grid No.2 connected to plate.

6AG7

POWER PENTODE

Metal type used in output stage of video amplifier of color and black-and-white television receivers. Outlines section, 2B; requires octal socket.

Heater Voltage (ac/dc)	6.3	volts
Heater Current	0.65	ampere
Peak Heater-Cathode Voltage	± 90 max	volts
Direct Interelectrode Capacitances:*		
Grid No.1 to Plate	0.06 max	pF
Grid No.1 to Cathode, Heater, Grid No.2, Grid No.3, Shell, and Internal Shield	13	pF
Plate to Cathode, Heater, Grid No.2, Grid No.3, Shell, and Internal Shield	7.5	pF

* Pins 1 and 3 connected to Pin No.5.

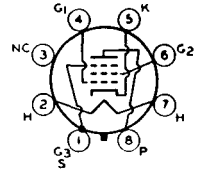

8Y

Class A₁ Amplifier

MAXIMUM RATINGS (Design-Center Values)

Plate Voltage	300	volts
Grid-No.2 Voltage	300	volts
Grid-No.1 Voltage, Positive-bias value	0	volts
Plate Dissipation	9	watts
Grid-No.2 Input	1.5	watts

CHARACTERISTICS

Plate Voltage	300	volts
Grid No.3 (Suppressor Grid)	Connected to cathode at socket	
Grid-No.2 (Screen-Grid) Voltage	150	volts
Grid-No.1 (Control-Grid) Voltage	—3	volts
Peak AF Grid-No.1 Voltage	3	volts
Zero-Signal Grid-No.2 Current	30	mA
Maximum-Signal Grid-No.2 Current	30.5	mA
Zero-Signal Grid-No.2 Current	7	mA
Maximum-Signal Grid-No.2 Current	9	mA
Plate Resistance	0.13	megohm
Transconductance	11000	μ mbos
Load Resistance	10000	ohms
Total Harmonic Distortion	7	per cent
Maximum-Signal Power Output	3	watts

MAXIMUM CIRCUIT VALUES

Grid-No.1-Circuit Resistance:		
For fixed-bias operation	0.25	megohm
For cathode-bias operation	1	megohm

6AG7Y

Refer to chart at end of section.

6AG9

MEDIUM-MU TRIODE— SHARP-CUTOFF PENTODE

Duodecar type with frame grid pentode unit used in color and black-and-white television receiver applications. The pentode unit is used as a video amplifier; the triode unit is used as an agc amplifier. Outlines section, 8C; requires duodecar 12-contact socket. Heater: volts (ac/dc), 6.3; amperes, 0.82; maximum heater-cathode volts, ± 200 peak, 100 average.

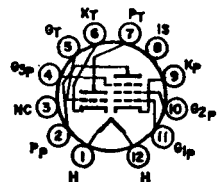

12HE

Class A₁ Amplifier

MAXIMUM RATINGS (Design-Maximum Values)

	Triode Unit	Pentode Unit	
Plate Voltage	330	330	volts
Grid-No.2 (Screen-Grid) Voltage	—	200	volts
Grid-No.1 (Control-Grid) Voltage, Positive-bias value	0	0	volts
Plate Dissipation	1.1	1.0	watts
Grid-No.2 Input	—	1.5	watts

CHARACTERISTICS

Plate Voltage	150	55	250	volts
Grid-No.2 Voltage	—	125	150	volts
Grid-No.1 Voltage	—	0	—	volts
Cathode-Bias Resistor	350	—	56	ohms
Amplification Factor	39	—	—	
Plate Resistance (Approx.)	8500	—	40000	ohms
Transconductance	4600	—	30000	μmhos
Plate Current	6.2	56	28	mA
Grid-No.2 Current	—	21	5.6	mA
Grid-No.1 Voltage (Approx.) for plate current of 20 μA	—7	—	—	volts
Grid-No.1 Voltage (Approx.) for plate current of 100 μA	—	—	—5.4	volts

MAXIMUM CIRCUIT VALUES

Grid-No.1-Circuit Resistance:			
For fixed-bias operation	0.5	0.1	megohm
For cathode-bias operation	1	0.25	megohm

Refer to chart at end of section.

6AG11

Refer to chart at end of section.

6AH4GT

Refer to chart at end of section.

6AH6

Refer to chart at end of section.

6AH9

Refer to chart at end of section.

6AJ8/ECH81

For replacement use type 6AK5/EF95.

6AK5

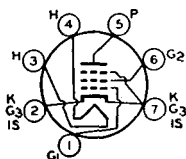

7BD

SHARP-CUTOFF PENTODE

6AK5/
EF95

Miniature types used as rf or if amplifiers especially in high-frequency wide-band applications at frequencies up to 400 MHz. Outlines section, 5B; require miniature 7-contact socket.

Heater Voltage (ac/dc)	6.3	volts
Heater Current	0.175	ampere
Peak Heater-Cathode Voltage	±90 max	volts
Direct Interelectrode Capacitances (Approx.):*		
Grid No.1 to Plate	0.02 max	pF
Grid No.1 to Cathode, Heater, Grid No.2, Grid No.3, and Internal Shield	4	pF
Plate to Cathode, Heater, Grid No.2, Grid No.3, and Internal Shield	2.8	pF

* With external shield connected to pin 2 or 7.

Class A₁ Amplifier

MAXIMUM RATINGS (Design-Center Values)

Plate Voltage	180	volts
Grid-No.2 (Screen-Grid) Voltage	See curve page 300	volts
Grid-No.2 Supply Voltage	180	volts
Grid-No.1 Voltage, Positive-bias value	0	volts
Plate Dissipation	1.7	watts
Grid-No.2 Input:		
For grid-No.2 voltages up to 90 volts	0.5	watt
For grid-No.2 voltages between 90 and 180 volts	See curve page 300	
Cathode Current	18	mA

CHARACTERISTICS

Plate Supply Voltage	120	180	volts
Grid-No.2 Supply Voltage	120	120	volts
Cathode-Bias Resistor	180	180	ohms
Plate Resistance (Approx.)	0.3	0.5	megohm
Transconductance	5000	5100	μ mbos
Plate Current	7.5	7.7	mA
Grid-No.2 Current	2.5	2.4	mA
Grid-No.1 Voltage for plate current of 10 μ A	-8.5	-8.5	volts

6AK6INDUSTRIAL
TYPE**POWER AMPLIFIER PENTODE**

Miniature type for use as a power output pentode in compact equipment. Outlines section, 5C; requires miniature 7-contact socket.

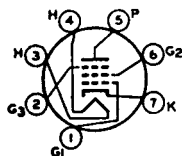
**7BK**

Heater Voltage (ac/dc)	6.3	volts
Heater Current	0.15	ampere
Heater-Cathode Voltage	100 max	volts
Direct Interelectrode Capacitances (Approx.):		
Grid to Plate	0.12	pF
Input	8.6	pF
Output	4.2	pF

A-F Power Amplifier**MAXIMUM RATINGS (Design-Center Values)**

Plate Voltage	300	volts
Screen Voltage (Grid No. 2)	250	volts
Plate Dissipation	2.75	watts
Screen Dissipation	0.75	watt

CHARACTERISTICS AND TYPICAL OPERATION

Plate Voltage	180	volts
Suppressor (Grid No. 3)	Connected to cathode at socket	
Screen Voltage	180	volts
Grid Voltage (Grid No. 1)	-9	volts
Peak A-F Grid Voltage	9	volts
Zero-Signal Plate Current	15	mA
Zero-Signal Screen Current	2.5	mA
Plate Resistance	0.2	megohm
Transconductance	2300	μ mbos
Load Resistance	10000	ohms
Total Harmonic Distortion	10	%
Max.-Sig. Power Output	1.1	watts

MAXIMUM CIRCUIT VALUES

Grid-No.1 Circuit Resistance:		
For fixed-bias operation	0.1	megohm
For cathode-bias operation	0.5	megohm

6AK8/EABC80

Refer to chart at end of section.

6AK10

Refer to chart at end of section.

6AL3

Refer to chart at end of section.

6AL3/EY88**HALF-WAVE
VACUUM RECTIFIER**

Miniature type used as damper tube in horizontal-deflection circuits of black-and-white television receivers. Outlines section, 7D; requires miniature 9-contact socket. Socket terminals 1, 2, 3, 6, 7, and 8 should not be used as tie points. It is especially important that this tube, like other power-handling tubes, be adequately ventilated. Heater: volts (ac/dc), 6.3; amperes, 1.55.

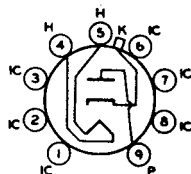
**9CB**

Damper Service

For operation in a 525-line, 30-frame system

MAXIMUM RATINGS (Design-Center Values)

Peak Inverse Plate Voltage# (Absolute maximum)	7500°	volts
Peak Plate Current	550	mA
Average Plate Current	220	mA
Plate Dissipation	5	watts
Peak Heater-Cathode Voltage	6600	volts

* Under no circumstances should this absolute value be exceeded.

Pulse duration must not exceed 15% of a horizontal scanning cycle (10 microseconds).

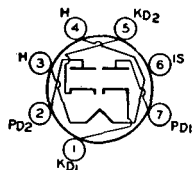

6BT

MHz. Outlines section, 5B; requires miniature 7-contact socket. Types 3AL5 and 12AL5 are identical with type 6AL5 except for heater ratings.

6AL5

3AL5, 12AL5

TWIN DIODE

Miniature, high-perveance type used as detector in FM and television circuits, especially as a ratio detector in ac-operated FM receivers. Each diode section can be used independently of the other, or the two sections can be combined in parallel or full-wave arrangement. Resonant frequency of each unit is approximately 700

Heater Voltage (ac/dc)	3AL5	6AL5	12AL5	volts
Heater Current	3.15	6.3	12.6	ampere
Heater Warm-up Time (Average)	0.6	0.3	0.15	seconds
Peak Heater-Cathode Voltage	11	—	—	volts
Direct Interelectrode Capacitances:	±330 max	±330 max	±330 max	
Plate No.1 to Cathode No.1, Heater, and Internal Shield	2.5	2.5	2.5	pF
Plate No.2 to Cathode No.2, Heater, and Internal Shield	2.5	2.5	2.5	pF
Cathode No.1 to Plate No.1, Heater, and Internal Shield	3.4	3.4	3.4	pF
Cathode No.2 to Plate No.2, Heater, and Internal Shield	3.4	3.4	3.4	pF
Plate No.1 to Plate No.2	0.068 max	0.068 max	0.068 max	pF

Half-Wave Rectifier

MAXIMUM RATINGS (Design-Center Values)

Peak Inverse Plate Voltage	330	volts
Peak Plate Current (Per Plate)	54	mA
Average Output Current (Per Plate)	9	mA

TYPICAL OPERATION

AC Plate Voltage per Plate (rms)	117	volts
Min. Total Effective Plate-Supply Impedance per Plate	300	ohms
Average Output Current per Plate	9	mA

Refer to chart at end of section.

6AL7GT

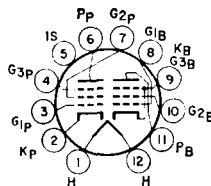

12BU

**BEAM POWER TUBE—
SHARP-CUTOFF PENTODE**

6AL11

10AL11, 12AL11

Duodecar type used as FM detector and audio-frequency output amplifier in television receivers. Outlines section, 8C; requires duodecar 12-contact socket. Types 10AL11 and 12AL11 are identical with type 6AL11 except for heater ratings.

Heater Voltage (ac/dc)	6AL11	10AL11	12AL11	volts
Heater Current	6.3	9.8	12.6	ampere
Heater Warm-up Time (Average)	0.9	0.6	0.45	seconds
Heater-Cathode Voltage:	—	11	11	
Peak value	±200 max	±200 max	±200 max	volts
Average value	100 max	100 max	100 max	volts

Direct Interelectrode Capacitance:

Beam Power Unit:		
Grid No.1 to Plate	0.26	pF
Grid No.1 to Cathode, Heater, Grid No.2, Grid No.3, and Internal Shield	11	pF
Plate to Cathode, Heater, Grid No.2, Grid No.3, and Internal Shield	12	pF
Pentode Unit:		
Grid No.1 to Plate	0.034	pF
Grid No.3 to Plate	3.2	pF
Grid No.1 to Cathode, Heater, Grid No.2, Grid No.3, and Internal Shield	6.5	pF
Grid No.3 to Cathode, Heater, Grid No.1, Grid No.2, Plate, and Internal Shield	7.5	pF
Grid No.1 to Grid No.3	0.24	pF
Pentode Plate to Beam Power Plate	0.12	pF

Beam Power Unit as Class A₁ Amplifier

MAXIMUM RATINGS (Design-Maximum Values)

Plate Voltage	275	volts
Grid-No.2 (Screen-Grid) Voltage	275	volts
Plate Dissipation	10	watts
Grid-No.2 Input	2	watts

TYPICAL OPERATION

Plate Voltage	250	volts
Grid-No.2 Voltage	250	volts
Grid-No.1 (Control-Grid) Voltage	-8	volts
Peak AF Grid-No.1 Voltage	8	volts
Zero-Signal Plate Current	35	mA
Maximum-Signal Plate Current	39	mA
Zero-Signal Grid-No.2 Current	2.5	mA
Maximum-Signal Grid-No.2 Current	7	mA
Plate Resistance (Approx.)	0.1	megohm
Transconductance	6500	μ mhos
Load Resistance	5000	ohms
Total Harmonic Distortion	10	per cent
Maximum-Signal Power Output	4.2	watts

MAXIMUM CIRCUIT VALUE

Grid-No.1-Circuit Resistance:		
For fixed-bias operation	0.25	megohm
For cathode-bias operation	0.5	megohm

Pentode Unit as Class A₁ Amplifier

CHARACTERISTICS

Plate Supply Voltage	150	volts
Grid-No.3 (Suppressor-Grid) Voltage	0	volts
Grid-No.2 (Screen-Grid) Supply Voltage	100	volts
Cathode-Bias Resistor	560	ohms
Plate Resistance (Approx.)	0.15	megohm
Transconductance, Grid No.1 to Plate	1000	μ mhos
Transconductance Grid No.3 to Plate	400	μ mhos
Plate Current	1.3	mA
Grid-No.2 Current	2.1	mA
Grid-No.1 Voltage (Approx.) for plate current of 30 μ A	-4.5	volts
Grid-No.3 Voltage (Approx.) for plate current of 50 μ A	-4.5	volts

Pentode Unit as FM Detector

MAXIMUM RATINGS (Design-Maximum Values)

Plate Voltage	330	volts
Grid-No.3 Voltage	28	volts
Grid-No.2 Supply Voltage	330	volts
Grid-No.2 Voltage	See curve page 300	
Grid-No.1 (Control-Grid) Voltage, Positive-bias value	0	volts
Plate Dissipation	1.7	watts
Grid-No.2 Input:		
For grid-No.2 voltages up to 165 volts	1.1	watts
For grid-No.2 voltages between 165 and 330 volts	See curve page 300	

6AM4

Refer to chart at end of section.

6AM6/EF91

Refer to chart at end of section.

Refer to chart at end of section.

6AM8

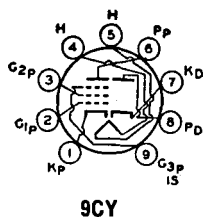

**DIODE—
SHARP-CUTOFF PENTODE**

6AM8A
5AM8

Miniature type used in television receiver applications. The pentode unit is used as an if amplifier, video amplifier, or agc amplifier. The high-perveance diode is used as an audio detector, video detector, or dc restorer. Outlines section, 6B; requires miniature 9-contact socket. Type 5AM8 is identical with type 6AM8A except for heater ratings.

	5AM8	6AM8A	
Heater Voltage (ac/dc)	4.7	6.3	volts
Heater Current	0.6	0.45	ampere
Heater Warm-up Time (Average)	100 max	100 max	volts
Heater-Cathode Voltage:			
Peak value	±200 max	±200 max	volts
Average value	100 max	100 max	volts

Direct Interelectrode Capacitances:

Diode Unit:			
Plate to Cathode and Heater	1.8		pF
Cathode to Plate and Heater	3		pF
Pentode Unit:			
Grid No.1 to Plate	0.015		pF
Grid No.1 to Cathode, Heater, Grid No.2, Grid No.3 and Internal Shield	6.5		pF
Plate to Cathode, Heater, Grid No.2, Grid No.3, and Internal Shield	2.6		pF
Pentode Grid No.1 to Diode Plate	0.006		pF
Pentode Plate to Diode Cathode	0.15		pF
Pentode Plate to Diode Plate	0.1		pF

Pentode Unit as Class A₁ Amplifier

MAXIMUM RATINGS (Design-Maximum Values)

Plate Voltage	330	volts
Grid-No.3 (Suppressor-Grid) Voltage, Positive value	0	volts
Grid-No.2 (Screen-Grid) Supply Voltage	330	volts
Grid-No.2 Voltage	See curve page 300	
Grid-No.1 (Control-Grid) Voltage, Positive-bias value	0	volts
Plate Dissipation	3.2	watts
Grid-No.2 Input:		
For grid-No.2 voltages up to 165 volts	0.55	watt
For grid-No.2 voltages between 165 and 330 volts	See curve page 300	

CHARACTERISTICS

Plate Supply Voltage	125	volts
Grid No.3	Connected to cathode at socket	
Grid-No.2 Supply Voltage	125	volts
Cathode-Bias Resistor	56	ohms
Plate Resistance (Approx.)	0.3	megohm
Transconductance	7800	μmhos
Plate Current	12.5	mA
Grid-No.2 Current	3.2	mA
Grid-No.1 Voltage (Approx.) for plate current of 20 μA	-6	volts
Grid-No.1 Voltage (Approx.) for plate current of 2 mA	-3	volts

MAXIMUM CIRCUIT VALUES

Grid-No.1-Circuit Resistance:		
For fixed-bias operation	0.25	megohm
For cathode-bias operation	1	megohm

Diode Unit

MAXIMUM RATING (Design-Maximum Value)

Average Plate Current	5	mA
-----------------------	---	----

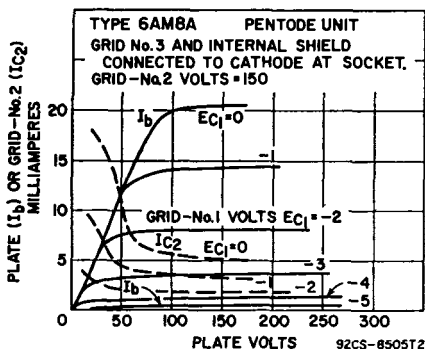
**6AN4**

Refer to chart at end of section.

6AN5

Refer to chart at end of section.

6AN8

Refer to chart at end of section.

6AN8A

5AN8

**MEDIUM-MU TRIODE—
SHARP-CUTOFF PENTODE**

Miniature type used in color television receiver applications. The pentode unit is used as an intermediate-frequency amplifier, a video amplifier, an agc amplifier, or a reactance tube. The triode unit is used in low-frequency oscillator, sync-separator, sync-clipper, and phase-splitter circuits. Outlines section, 6B; requires miniature 9-contact socket. Type 5AN8 is identical with 6AN8A except for heater ratings.

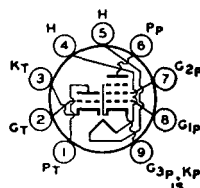
**9DA**

Heater Voltage (ac/dc)	5AN8	6AN8A	
Heater Current	4.7	6.3	volts
Heater Warm-up Time (Average)	0.6	0.45	ampere
Heater-Cathode Voltage:	11	11	seconds
Peak value	±200 max	±200 max	volts
Average value	100 max	100 max	volts
Direct Interelectrode Capacitances:			
Triode Unit:			
Grid to Plate		1.5	pF
Grid to Cathode and Heater		2	pF
Plate to Cathode and Heater		0.26	pF
Pentode Unit:			
Grid No.1 to Plate		0.04 max	pF
Grid No.1 to Cathode, Heater, Grid No.2, Grid No.3, and Internal Shield		7	pF
Plate to Cathode, Heater, Grid No.2, Grid No.3, and Internal Shield		2.4	pF
Triode Grid to Pentode Plate		0.02	pF
Pentode Grid No.1 to Triode Plate		0.02	pF
Pentode Plate to Triode Plate		0.15	pF

Class A₁ Amplifier**MAXIMUM RATINGS (Design-Maximum Values)**

	Triode Unit	Pentode Unit	
Plate Voltage	330	330	volts
Grid-No.2 Supply Voltage	—	330	volts
Grid-No.2 (Screen-Grid) Voltage	—	See curve page 300	
Grid-No.1 (Control-Grid) Voltage, Positive-bias value	0	0	volts
Plate Dissipation	2.8	2.3	watts

Grid-No.2 Input:

For grid-No.2 voltages up to 165 volts	—	0.55	watt
For grid-No.2 voltages between 165 and 330 volts	—	See curve page 300	

CHARACTERISTICS

Plate Supply Voltage	150	125	volts
Grid-No.2 Supply Voltage	—	125	volts
Grid-No.1 Voltage	-8	—	volts
Cathode-Bias Resistor	—	56	ohms
Amplification Factor	21	—	
Plate Resistance (Approx.)	4700	170000	ohms
Transconductance	4500	7800	μ mhos
Plate Current	15	12	mA
Grid-No.2 Current	—	3.8	mA
Grid-No.1 Voltage (Approx.) for plate current of 20 μ A	-17	-6	volts
Grid-No.1 Voltage (Approx.) for plate current of 1.6 mA	—	-3	volts

MAXIMUM CIRCUIT VALUES

Grid-No.1-Circuit Resistance:*			
For fixed-bias operation	0.5	0.25	megohm
For cathode-bias operation	1	1	megohm

* If either unit is operating at maximum rated conditions, grid-No.1-circuit resistance for both units should not exceed the stated values.

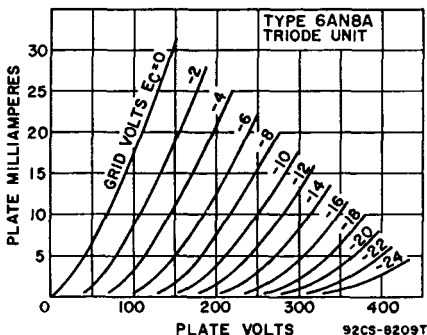
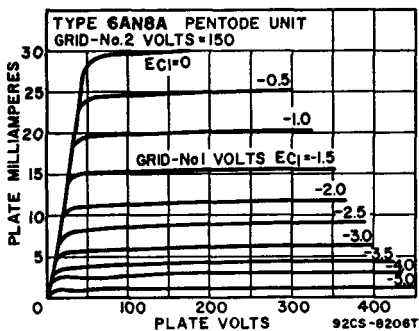

Refer to chart at end of section.

6AQ5

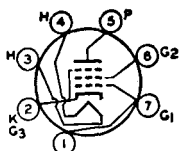

7BZ

BEAM POWER TUBE

6AQ5A

5AQ5, 12AQ5

Miniature type used as output amplifier in automobile receivers and in ac-operated receivers and, triode-connected, as a vertical-deflection amplifier in television receivers. Outlines section, 5D; requires miniature 7-contact socket. Within its maximum ratings, the performance of this type is equivalent to that of larger types 6V6 and 6V6GTA. Types 5AQ5 and 12AQ5 are identical with type 6AQ5A except for heater ratings.

Heater Voltage (ac/dc)	5AQ5	6AQ5A	12AQ5	
Heater Current	4.7	6.3	12.6	volts
Heater Warm-up Time (Average)	0.6	0.45	0.225	ampere
Heater-Cathode Voltage:				seconds
Peak value	± 200 max	± 200 max	± 200 max	volts
Average value	100 max	100 max	100 max	volts
Direct Interelectrode Capacitances (Approx.):				
Grid No.1 to Plate			0.4	pF
Grid No.1 to Cathode, Heater, Grid No.2, and Grid No.3			8	pF
Plate to Cathode, Heater, Grid No.2, and Grid No.3			8.5	pF

Class A₁ Amplifier

MAXIMUM RATINGS (Design-Maximum Values)

Plate Voltage	275	volts
Grid-No.2 (Screen-Grid) Voltage	275	volts
Plate Dissipation	12	watts
Grid-No.2 Input	2	watts
Bulb Temperature (At hottest point)	250	°C

CHARACTERISTICS (Triode Connection)

Plate Voltage	250	volts
Grid-No.1 Voltage	-12.5	volts
Amplification Factor	9.5	
Plate Resistance (Approx.)	1970	ohms
Transconductance	4800	μmhos
Plate Current	49.5	mA
Grid-No.1 Voltage (Approx.) for plate current of 0.5 mA	-37	volts

TYPICAL OPERATION

Same as for type 6V6GTA within the limitations of the maximum ratings.

MAXIMUM CIRCUIT VALUES

Grid-No.1-Circuit Resistance:		
For fixed-bias operation	0.1	megohm
For cathode-bias operation	0.5	megohm

Vertical Deflection Amplifier (Triode Connection)^o

For operation in a 525-line, 30-frame system

MAXIMUM RATINGS (Design-Maximum Values)

DC Plate Voltage	275	volts
Peak Positive-Pulse Plate Voltage [#]	1100	volts
Peak Negative-Pulse Grid-No.1 (Control-Grid) Voltage	275	volts
Peak Cathode Current	115	mA
Average Cathode Current	40	mA
Plate Dissipation	10	watts
Bulb Temperature (At hottest point)	250	°C

MAXIMUM CIRCUIT VALUE

Grid-No.1-Circuit Resistance, for cathode-bias operation	2.2	megohms
----------------------------------------------------------	-----	---------

^o Grid No.2 connected to plate.

[#] Pulse duration must not exceed 15% of a vertical scanning cycle (2.5 milliseconds).

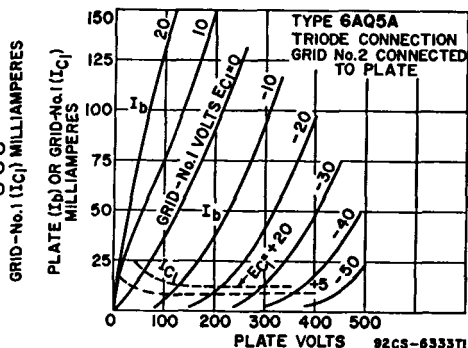
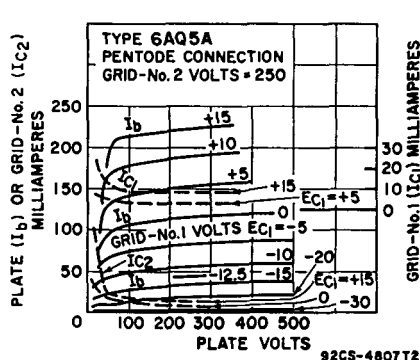

6AQ6

Refer to chart at end of section.

6AQ7GT

Refer to chart at end of section.

6AQ8

Refer to chart at end of section.

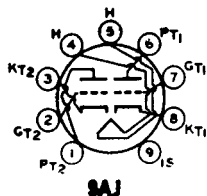

HIGH-MU TWIN TRIODE

**6AQ8/
ECC85**

Miniature types used as rf amplifier and self-oscillating mixer in FM/AM radio receivers. Outlines section, 6B; requires miniature 9-contact socket.

Heater Voltage (ac/dc)	6.3	volts
Heater Current	0.435	ampere
Peak Heater-Cathode Voltage	±90 max	volts

Direct Interelectrode Capacitances:	Unit No.1	Unit No.2	
Grid to Plate	1.5	1.5	pF
Cathode to Plate	0.18	0.18	pF
Grid to Cathode, Heater, and Internal Shield	3	3	pF
Plate to Cathode, Heater, and Internal Shield	1.2	1.2	pF
Plate to Grid of Other Unit	0.008 max	0.008 max	pF
Plate to Cathode of Other Unit	0.008 max	0.008 max	pF
Grid to Cathode of Other Unit	0.003 max	0.003 max	pF
Plate of Unit No.1 to Plate of Unit No.2		0.04 max	pF
Grid of Unit No.1 to Grid of Unit No.2		0.003 max	pF

Class A, Amplifier

MAXIMUM RATINGS (Design-Maximum Values, Each Unit)

Plate Supply Voltage	550	volts
Plate Voltage	300	volts
Grid Voltage, Negative-bias value	100	volts
Cathode Current	15	mA
Plate Dissipation:		
For either plate	2.5	watts
For both plates with both units operating	4.5	watts

CHARACTERISTICS

Plate Voltage	250	volts
Grid Voltage, Negative-bias value	2.3	volts
Plate Current	10	mA
Transconductance	5900	μmhos
Amplification Factor	57	

TYPICAL OPERATION (Each Unit)

	RF Amplifier	Converter	
Plate Supply Voltage	250	250	volts
Plate Voltage	230	—	volts
Plate Resistor	1800	12000	ohms
Grid Resistor	—	1	megohm
Grid Voltage	—2	—	volts
RMS Oscillator Voltage	—	3	volts
Cathode-Bias Resistor	200	—	ohms
Plate Resistance (Approx.)	9700	22000	ohms
Transconductance	6000	—	μmhos
Conversion Transconductance	—	2300	μmhos
Input Resistance at frequency of 100 MHz	6000	15000	ohms
Plate Current	10	5.2	mA
Equivalent Noise Resistance	500	—	ohms

MAXIMUM CIRCUIT VALUES (Each Unit)

Grid-Circuit Resistance	1	megohm
Resistance between Cathode and Heater	20000	ohms

Refer to chart at end of section.

6AR5

Refer to chart at end of section.

6AR8

6AR11

8AR11, 11AR11

Duodecar type used as if-amplifier tube in television receivers. Outlines section, 8A; requires duodecar 12-contact-socket. Types 8AR11 and 11AR11 are identical with type 6AR11 except for heater ratings.

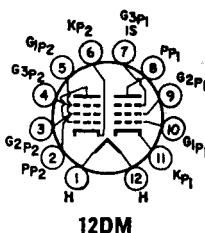
**SEMIREMOTE-CUTOFF
TWIN PENTODE****12DM**

	6AR11	8AR11	11AR11	
Heater Voltage (ac/dc)	6.3	8.4	11.2	volts
Heater Current	0.8	0.6	0.45	ampere
Heater Warm-up Time (Average)	—	11	11	seconds
Heater-Cathode Voltage:				
Peak value	±200 max	±200 max	±200 max	volts
Average value	100 max	100 max	100 max	volts
Direct Interelectrode Capacitances:				
Grid No.1 to Plate	Unit No.1		Unit No.2	
Grid No.1 to Plate	0.026		0.026	pF
Grid No.1 to Cathode, Heater, Grid No.2, Grid No.3, and Internal Shield	10		10	pF
Plate to Cathode, Heater, Grid No.2, Grid No.3, and Internal Shield	2.8		3	pF
Grid No.1 to Plate of Other Unit	0.002		0.002	pF
Plate of Unit No.1 to Plate of Unit No.2			0.02	pF

Class A₁ Amplifier**MAXIMUM RATINGS (Design-Maximum Values, Each Unit)**

Plate Voltage	330	volts
Grid-No.3 (Suppressor-Grid) Voltage, Positive value	0	volts
Grid-No.2 (Screen-Grid) Supply Voltage	330	volts
Grid-No.2 Voltage	See curve page 300	
Grid-No.1 (Control-Grid) Voltage, Positive-bias value	0	volts
Plate Dissipation	3.1	watts
Grid-No.2 Input:		
For grid-No.2 voltages up to 165 volts	0.65	watt
For grid-No.2 voltages between 165 and 330 volts	See curve page 300	

CHARACTERISTICS (Each Unit)

Plate Supply Voltage	125	volts
Grid No.3	Connected to cathode at socket	
Grid-No.2 Supply Voltage	125	volts
Cathode-Bias Resistor	56	ohms
Plate Resistance (Approx.)	0.2	megohm
Transconductance	10500	μmhos
Plate Current	11	mA
Grid-No.2 Current	3.5	mA
Grid-No.1 Voltage (Approx.) for transconductance of 50 μmhos	—15	volts

6AS5**BEAM POWER TUBE**

Miniature type used as output amplifier primarily in automobile and in ac-operated receivers. Outlines section, 5D; requires miniature 7-contact socket. For curves of average plate characteristics, refer to type 35C5.

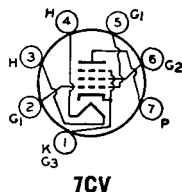
**7CV**

Heater Voltage (ac/dc)	6.3	volts
Heater Current	0.8	ampere
Peak Heater-Cathode Voltage	±100 max	volts
Direct Interelectrode Capacitances (Approx.):		
Grid No.1 to Plate	0.6	pF
Grid No.1 to Cathode, Heater, Grid No.2, and Grid No.3	12	pF
Plate to Cathode, Heater, Grid No.2, and Grid No.3	9	pF

Class A₁ Amplifier

MAXIMUM RATINGS (Design-Center Values)

Plate Voltage	150	volts
Grid-No.2 (Screen-Grid) Voltage	117	volts
Plate Dissipation	5.5	watts
Grid-No.2 Input	1.0	watt
Bulb Temperature (At hottest point)	250	°C

TYPICAL OPERATION

Plate Voltage	150	volts
Grid-No.2 Voltage	110	volts
Grid-No.1 (Control-Grid) Voltage	-8.5	volts
Peak AF Grid-No.1 Voltage	8.5	volts
Zero-Signal Plate Current	35	mA
Maximum-Signal Plate Current	36	mA
Zero-Signal Grid-No.2 Current (Approx.)	2	mA
Maximum-Signal Grid-No.2 Current (Approx.)	6.5	mA
Transconductance	5600	μmhos
Load Resistance	4500	ohms
Total Harmonic Distortion	10	per cent
Maximum-Signal Power Output	2.2	watts

MAXIMUM CIRCUIT VALUES

Grid-No.1-Circuit Resistance:		
For fixed-bias operation	0.1	megohm
For cathode-bias operation	0.5	megohm

Refer to chart at end of section.

6A56

6AS7G
INDUSTRIAL
TYPE

LOW-MU TWIN POWER TRIODE

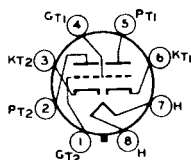

8BD

Glass octal type used as a regulator tube in dc power supply units and in projection television booster scanning applications. Outlines section, 27B; requires octal socket. Refer to type 6080 for average plate characteristics curves.

Heater Voltage (ac/dc)	6.3	volts
Heater Current	2.5	amperes
Heater-Cathode Voltage:		
Peak values	±300 max.	volts
Direct Interelectrode Capacitances (Approx.) each unit:		
Grid to plate	10.5	pF
Grid to heater and cathode	6.8	pF
Plate to heater and cathode	2.3	pF
Heater to cathode	11.0	pF
Grid of unit No. 1 to grid of unit No. 2	0.70	pF
Plate of unit No. 1 to plate of unit No. 2	1.65	pF

Class A₁ Amplifier (Each Unit)

CHARACTERISTICS

Plate-Supply Voltage	135	volts
Cathode-Bias Resistor [■]	250	ohms
Amplification Factor	2	
Plate Resistance (Approx.)	280	ohms
Transconductance	7000	μmhos
Plate Current	125	mA

DC Amplifier (Each Unit)

MAXIMUM RATINGS (Design-Center Values)

Plate Voltage	250	volts
Plate Current	125	mA
Plate Dissipation	13	watts

[■] Operation with fixed bias is not recommended.

Booster Scanning Service (Each Unit)

For operation in a 525-line, 30-frame system[□]

MAXIMUM RATINGS (Design-Center Values)

Peak Negative-Pulse Plate Voltage [●]	1700	volts
DC Plate Current	125	mA
Plate Dissipation	13	watts

MAXIMUM CIRCUIT VALUES

Grid-Circuit Resistance:		
For cathode-bias operation	1.0	megohm
For fixed-bias operation		Not recommended
□ As described in "Standards of Good Engineering Practice Concerning Television Broadcast Stations", Federal Communications Commission.		
● The duration of the voltage pulse must not exceed 15 per cent of one horizontal scanning cycle. In a 525-line, 30-frame system, 15 per cent of one horizontal scanning cycle is 10 microseconds.		

6AS7GA

Refer to chart at end of section.

6AS8**DIODE—
SHARP-CUTOFF PENTODE**

Miniature type used in television and radio receiver applications. The pentode unit is used as an if amplifier, video amplifier, or agc amplifier. The high-perveance diode is used as an audio detector, video detector, or dc restorer. Outlines section, 6B; requires miniature 9-contact socket. For curve of average plate characteristics of pentode unit, see type 6AN8A.

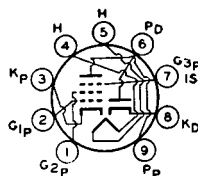
**9DS**

Heater Voltage (ac/dc)	6.3	volts
Heater Current	0.45	ampere
Heater Warm-up Time (Average)	—	seconds
Heater-Cathode Voltage:		
Peak value	±200 max	volts
Average value	100 max	volts
Direct Interelectrode Capacitances:		
Diode Unit:		
Plate to Cathode, Heater, Pentode Grid No.3, and Internal Shield	3	pF
Pentode Unit:		
Grid No.1 to Plate	0.03	pF
Grid No.1 to Cathode, Heater, Grid No.2, Grid No.3, and Internal Shield	7	pF
Plate to Cathode, Heater, Grid No.2, Grid No.3, and Internal Shield	2.4	pF
Pentode Grid No.1 to Diode Plate	0.005 max	pF
Pentode Plate to Diode Cathode	0.15 max	pF
Pentode Plate to Diode Plate	0.10 max	pF

Pentode Unit as Class A₁ Amplifier**MAXIMUM RATINGS (Design-Center Values)**

Plate Voltage	300	volts
Grid-No.3 (Suppressor-Grid) Voltage, Positive value	0	volts
Grid-No.2 Supply Voltage	300	volts
Grid-No.2 (Screen-Grid) Voltage	See curve page 300	
Grid-No.1 (Control-Grid) Voltage, Positive-bias value	0	volts
Plate Dissipation	2.5	watts
Grid-No.2 Input:		
For grid-No.2 voltages up to 150 volts	0.5	watt
For grid-No.2 voltages between 150 and 300 volts	See curve page 300	

CHARACTERISTICS

Plate Supply Voltage	200	volts
Grid No.3	Connected to cathode at socket	
Grid-No.2 Supply Voltage	150	volts
Cathode-Bias Resistor	180	ohms
Plate Resistance (Approx.)	300000	ohms
Transconductance	6200	μmhos
Plate Current	9.5	mA
Grid-No.2 Current	3	mA
Grid-No.1 Voltage (Approx.) for plate current of 10 μA	—8	volts

MAXIMUM CIRCUIT VALUES

Grid-No.1-Circuit Resistance:		
For fixed-bias operation	0.25	megohm
For cathode-bias operation	1	megohm

Diode Unit

MAXIMUM RATINGS (Design-Center Values)

Peak Inverse Plate Voltage	330	volts
Peak Plate Current	50	mA
Average Plate Current	5	mA

Refer to chart at end of section.

6AS11

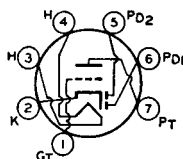

7BT

TWIN DIODE—
HIGH-MU TRIODE

6AT6

12AT6

Miniature type used as a combined detector, amplifier, and avc tube in automobile and ac-operated radio receivers. Outlines section, 5C; requires miniature 7-contact socket. For typical operation as resistance-coupled amplifier refer to Resistance-Coupled Amplifier section. Type 12AT6 is identical with type 6AT6 except for heater ratings.

Heater Voltage (ac/dc)	6.3	12.6	volts
Heater Current	0.3	0.15	ampere
Peak Heater-Cathode Voltage	±90 max	±90 max	volts
Direct Interelectrode Capacitances:			
Triode Grid to Triode Plate		2	pF
Triode Grid to Cathode and Heater		2.2	pF
Triode Plate to Cathode and Heater		0.8	pF
Plate of Diode Unit No.2 to Triode Grid		0.04 max	pF

Triode Unit as Class A₁ Amplifier

MAXIMUM RATINGS (Design-Center Values)

Plate Voltage	300	volts
Plate Dissipation	0.5	watts
Grid Voltage, Positive-bias value	0	volts

CHARACTERISTICS

Plate Voltage	100	250	volts
Grid Voltage	-1	-3	volts
Amplification Factor	70	70	
Plate Resistance	54000	58000	ohms
Transconductance	1300	1200	μmhos
Plate Current	0.8	1	mA

Diode Units

MAXIMUM RATING (Design-Center Value)

Plate Current (Each Unit)	1	mA
---------------------------------	---	----

The two diode plates are placed around a cathode whose sleeve is common to the triode unit. Each diode plate has its own base pin. For diode operation curves, refer to type 6AV6.

Refer to chart at end of section.

6AT8

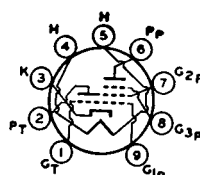

9DW

MEDIUM-MU TRIODE—
SHARP-CUTOFF PENTODE

6AT8A

5AT8

Miniature types used as combined oscillator and mixer tubes in television receivers utilizing an intermediate frequency in the order of 40 MHz. Outlines section, 6B; requires miniature 9-contact socket. Except for interelectrode capacitances and basing arrangement, this type is identical with miniature type 6X8. The basing

arrangement is particularly suitable for connection to the coils of certain designs of turret tuners. Type 5AT8 is identical with type 6AT8A except for heater ratings.

Heater Voltage (ac/dc)	5AT8	6AT8A	
Heater Current	4.7	6.3	volts
Heater Warm-up Time (Average)	0.6	0.45	ampere
Direct Interelectrode Capacitances:	11	11	seconds
Triode Unit:	Unshielded	Shielded*	
Grid to Plate	1.5	1.5	pF
Grid to Cathode and Heater	2	2.4	pF
Plate to Cathode and Heater	0.5	1	pF
Pentode Unit:			
Grid No.1 to Plate	0.06 max	0.03 max	pF
Grid No.1 to Cathode, Heater, Grid No.2 and Grid No.3	4.6	4.8	pF
Plate to Cathode, Heater, Grid No.2, and Grid No.3	0.9	1.6	pF
Pentode Grid No.1 to Triode Plate	0.05 max	0.04 max	pF
Pentode Plate to Triode Plate	0.05 max	0.008 max	pF
Heater to Cathode	6	6†	pF

* With external shield connected to cathode except as noted.
 † With external shield connected to plate.

6AU4GT

Refer to chart at end of section.

6AU4GTA

**HALF-WAVE
VACUUM RECTIFIER**

Glass octal type used as damper tube in horizontal-deflection circuits of color and wide-angle picture-tube television receivers. Outlines section, 13G; requires octal socket. Type may be supplied with pin No. 1 omitted. Socket terminals 1, 2, 4, and 6 should not be used as tie points. This tube, like other power-handling tubes, should be adequately ventilated.

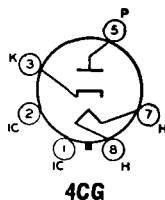

Heater Voltage (ac/dc)	6.3	volts
Heater Current	1.8	amperes
Direct Interelectrode Capacitances (Approx.):		
Plate to Heater and Cathode	8.5	pF
Cathode to Heater and Plate	11.5	pF
Heater to Cathode	4	pF

Damper Service

For operation in a 525-line, 30-frame system

MAXIMUM RATINGS (Design-Maximum Values)

Peak Inverse Plate Voltage#	4500	volts	
Peak Plate Current	1300	mA	
Average Plate Current	210	mA	
Plate Dissipation	6.5	watts	
Heater-Cathode-Voltage:			
Peak value	+300	-4500	volts
Average value	+100	-900	volts

Pulse duration must not exceed 15% of a horizontal scanning cycle (10 microseconds).

6AU5GT

BEAM POWER TUBE

Glass octal type used as horizontal-deflection amplifier in low-cost, high-efficiency deflection circuits of television receivers. Outlines section, 13D; requires octal socket.

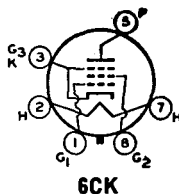

Heater Voltage (ac/dc)	6.3	volts
Heater Current	1.25	amperes
Heater-Cathode Voltage:		
Peak value	±200 max	volts
Average value	100 max	volts
Direct Interelectrode Capacitances (Approx.):		
Grid No.1 to Plate	0.5	pF
Grid No.1 to Cathode, Heater, Grid No.2, and Grid No.3	11.3	pF
Plate to Cathode, Heater, Grid No.2, and Grid No.3	7	pF

Class A₁ Amplifier

CHARACTERISTICS

	Pentode Connection	Triode† Connection	
Plate Voltage	115	110	volts
Grid-No.2 (Screen-Grid) Voltage	175	100	volts
Grid-No.1 (Control-Grid) Voltage	-20	-4.5	volts
Plate Resistance	6000	—	ohms
Transconductance	5600	—	μmhos
Plate Current	60	—	mA
Grid No.2 Current	6.8	—	mA

† Grid No.2 connected to plate.

Horizontal-Deflection Amplifier

For operation in a 525-line, 30-frame system

MAXIMUM RATINGS (Design-Center Values)

DC Plate Voltage	550	volts
Peak Positive-Pulse Plate Voltage* (Absolute Maximum)	5500*	volts
Peak Negative-Pulse Plate Voltage	1250	volts
DC Grid-No.2 (Screen-Grid) Voltage*	200	volts
Peak Negative-Pulse Grid-No.1 (Control-Grid) Voltage	300	volts
Peak Cathode Current	400	mA
Average Cathode Current	110	mA
Grid-No.2 Input	2.5	watts
Plate Dissipation††	10	watts
Bulb Temperature (At hottest point)	210	°C

MAXIMUM CIRCUIT VALUE

Grid-No.1-Circuit Resistance	0.47	megohm
------------------------------------	------	--------

* Pulse duration must not exceed 15% of a horizontal scanning cycle (10 microseconds).

* Under no circumstances should this absolute value be exceeded.

* Obtained through a series dropping resistor of sufficient magnitude to limit the grid-No.2 input to the rated maximum value.

†† A bias resistor or other means is required to protect the tube in absence of excitation.

Refer to chart at end of section.

6AU6

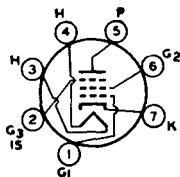

7BK

6AU6A

3AU6, 4AU6, 12AU6

SHARP-CUTOFF PENTODE

Miniature type used in compact radio equipment as rf amplifier especially in high-frequency, wide-band applications; also used as limiter tube in FM equipment. Outlines section, 5C; requires miniature 7-contact socket. For a discussion of limiters, refer to Electron Tube Applications section. For typical operation as

resistance-coupled amplifier, refer to Resistance-Coupled Amplifier section. Types 3AU6, 4AU6, and 12AU6 are identical with type 6AU6A except for heater ratings.

	3AU6	4AU6	6AU6A	12AU6	
Heater Voltage (ac/dc)	3.15	4.2	6.3	12.6	volts
Heater Current	0.6	0.45	0.3	0.15	ampere
Heater Warm-up Time (Average)	11	11	11	—	seconds
Heater-Cathode Voltage:					
Peak value	±200 max	±200 max	±200 max	±200 max	volts
Average value	100 max	100 max	100 max	100 max	volts

Direct Interelectrode Capacitances:

Pentode Connection:

Grid No.1 to Plate	0.0035 max	pF
Grid No.1 to Cathode, Heater, Grid No.2, Grid No.3, and Internal Shield	5.5	pF
Plate to Cathode, Heater, Grid No.2, Grid No.3, and Internal Shield	5	pF
Triode Connection:†		
Grid No.1 to Plate, Grid No.2, Grid No.3, and Internal Shield	2.6	pF
Grid No.1 to Cathode and Heater	3.2	pF
Plate, Grid No.2, Grid No.3, and Internal Shield to Cathode and Heater	1.2*	pF

† Grid No.2, grid No.3, and internal shield connected to plate.

* Value is 8.5 pF with external shield connected to cathode.

Class A₁ Amplifier

MAXIMUM RATINGS (Design-Maximum Values)

	Triode† Connection	Pentode Connection	
Plate Voltage	275	330	volts
Grid-No.3 (Suppressor-Grid) Voltage, Positive value	—	0	volts
Grid-No.2 (Screen-Grid) Voltage	See curve page 300		
Grid-No.2 Supply Voltage	—	330	volts
Grid-No.1 (Control-Grid) Voltage, Positive-bias value	0	0	volts
Plate Dissipation	3.5	3.5	watts
Grid-No.2 Input:			
For grid-No.2 voltages up to 165 volts	—	0.75	watt
For grid-No.2 voltages between 165 and 330 volts	See curve page 300		

CHARACTERISTICS

	Triode† Connection	Pentode Connection			
Plate Supply Voltage	250	100	250	150	volts
Grid No.3	—	Connected to cathode		at socket	
Grid-No.2 Supply Voltage	—	100	125	150	volts
Cathode-Bias Resistor	330	150	100	68	ohms
Amplification Factor	36	—	—	—	
Plate Resistance (Approx.)	—	0.5	1.5	1	megohms
Transconductance	4800	3900	4500	5200	μmhos
Plate Current	12.2	5	7.6	10.6	mA
Grid-No.2 Current	—	2.1	3	4.3	mA
Grid-No.1 Voltage for plate current of 10 μA	—	-4.2	-5.5	-6.5	volts

† Grid No.2, grid No.3, and internal shield connected to plate.

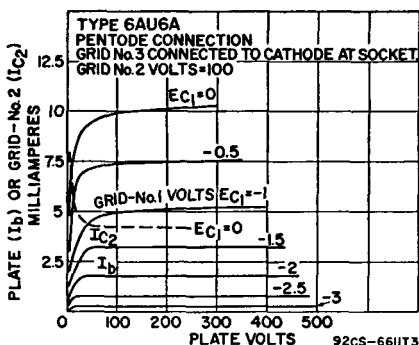

6AU7

Refer to chart at end of section.

6AU8

Refer to chart at end of section.

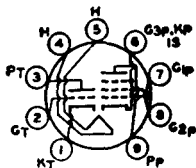

9DX

**MEDIUM-MU TRIODE—
SHARP-CUTOFF PENTODE**

6AU8A

Miniature type used in television receiver applications. Pentode unit is used as video amplifier, if amplifier, and agc amplifier. Triode unit is used in sync-amplifier, sync-separator, sync-clipper, and phase-inverter circuits. Outlines section, 6E; requires 9-contact socket.

Heater Voltage (ac/dc)	6.3	volts
Heater Current	0.6	ampere
Heater Warm-up Time (Average)	11	seconds
Heater-Cathode Voltage:		
Peak value	±200 max	volts
Average value	100 max	volts
Direct Interelectrode Capacitances:		
Triode Unit:		
Grid to Plate	2.2	pF
Grid to Cathode and Heater	2.6	pF
Plate to Cathode and Heater	0.34	pF
Pentode Unit:		
Grid No.1 to Plate	0.06	pF
Grid No.1 to Cathode, Heater, Grid No.2, Grid No.3, and Internal Shield	7.5	pF
Plate to Cathode, Heater, Grid No.2, Grid No.3, and Internal Shield	3.4	pF
Triode Grid to Pentode Plate	0.022 max	pF
Pentode Grid No.1 to Triode Plate	0.006 max	pF
Pentode Plate to Triode Plate	0.12 max	pF

Class A₁ Amplifier

MAXIMUM RATINGS (Design-Maximum Values)

	Triode Unit	Pentode Unit	
Plate Voltage	330	330	volts
Grid-No.2 (Screen-Grid) Supply Voltage	—	330	volts
Grid-No.2 Voltage	—	See curve page 300	
Grid-No.1 (Control-Grid) Voltage, Positive-bias value	0	0	volts
Plate Dissipation	2.8	3.3	watts
Grid-No.2 Input:			
For grid-No.2 voltages up to 165 volts	—	1	watt
For grid-No.2 voltages between 165 and 330 volts	—	See curve page 300	

CHARACTERISTICS

Plate Supply Voltage	150	200	volts
Grid-No.2 Supply Voltage	—	125	volts
Cathode-Bias Resistor	150	82	ohms
Amplification Factor	43	—	
Plate Resistance (Approx.)	8100	100000	ohms
Transconductance	5300	8000	μmhos
Plate Current	9.5	17	mA
Grid-No.2 Current	—	3.4	mA
Grid-No.1 Voltage (Approx.) for plate current of 100 μA	-6.5	-7.5	volts

MAXIMUM CIRCUIT VALUES

Grid-No.1-Circuit Resistance:			
For fixed-bias operation	0.5	0.25	megohm
For cathode-bias operation	1	1	megohm

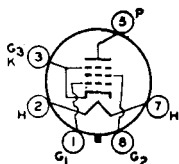

6CK

BEAM POWER TUBE

6AV5GA

12AV5GA, 25AV5GA

Glass octal type used as horizontal-deflection amplifier in television receivers. Outlines section, 19C; requires octal socket. Types 12AV5GA and 25AV5GA are identical with type 6AV5GA except for heater ratings.

	6AV5GA	12AV5GA	25AV5GA	
Heater Voltage (ac/dc)	6.3	12.6	25	volts
Heater Current	1.2	0.6	0.3	amperes
Heater Warm-up Time (Average)	—	11	—	seconds

Heater-Cathode Voltage:

Peak value	±200 max	±200 max	±200 max	volts
Average value	100 max	100 max	100 max	volts
Direct Interelectrode Capacitances (Approx.)				
Grid No.1 to Plate			0.5	pF
Grid No.1 to Cathode, Heater, Grid No.2, and Grid No.3			14	pF
Plate to Cathode, Heater, Grid No.2, and Grid No.3			7	pF

Class A₁ Amplifier

CHARACTERISTICS

	Pentode Connection	Triode* Connection	
Plate Voltage	60	150	volts
Grid-No.2 (Screen-Grid) Voltage	150	150	volts
Grid-No.1 (Control-Grid) Voltage	0	-22.5	volts
Plate Resistance	—	14500	ohms
Transconductance	—	5900	μmhos
Plate Current	280	57	mA
Screen Current	26	2.1	mA
Grid-No.1 Voltage (Approx.) for plate current of 1 mA	—	-43	volts
Amplification Factor	—	—	—
		4.3	

* Grid No.2 connected to plate.

Horizontal-Deflection Amplifier

For operation in a 525-line, 30-frame system

MAXIMUM RATINGS (Design-Center Values)

DC Plate Voltage	550	volts
Peak Positive-Pulse Plate Voltage* (Absolute Maximum)	5500*	volts
Peak Negative-Pulse Plate Voltage	1250	volts
DC Grid-No.2 Voltage	175	volts
Peak Negative-Pulse Grid-No.1 Voltage	300	volts
Peak Cathode Current	400	mA
Average Cathode Current	110	mA
Grid-No.2 Input	2.5	watts
Plate Dissipation††	11	watts
Bulb Temperature (At hottest point)	210	°C

MAXIMUM CIRCUIT VALUE

Grid-No.1-Circuit Resistance	0.47	megohm
------------------------------	------	--------

Pulse duration must not exceed 15% of a horizontal scanning cycle (10 microseconds).

* Under no circumstances should this absolute value be exceeded.

†† A bias resistor or other means is required to protect the tube in absence of excitation.

6AV5GT

Refer to chart at end of section.

6AV6

4AV6, 12AV6

TWIN DIODE—
HIGH-MU TRIODE

Miniature type used as combined detector, amplifier, and avc tube in automobile and ac-operated radio receivers. The 6AV6 may be substituted directly for the 6AT6 in applications where the higher amplification of the 6AV6 is advantageous. Outlines section, 5C; requires miniature 7-contact socket. Types 4AV6, and 12AV6 are identical with type 6AV6 except for heater ratings.

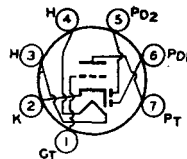

7BT

	4AV6	6AV6	12AV6	
Heater Voltage (ac/dc)	4.2	6.3	12.6	volts
Heater Current	0.45	0.3	0.15	ampere
Heater Warm-up Time (Average)	11	—	—	seconds
Heater-Cathode Voltage:				
Peak value	±200 max	±200 max	±200 max	volts
Average value	100 max	100 max	100 max	volts
Direct Interelectrode Capacitances:				
Triode Grid to Triode Plate			2	pF
Triode Grid to Cathode and Heater			2.2	pF
Triode Plate to Cathode and Heater			0.8*	pF
Plate of Diode Unit No.2 to Triode Grid			0.04 max	pF

* This value is 1.2 pF with external shield connected to cathode.

Triode Unit as Class A₁ Amplifier

MAXIMUM RATING (Design-Maximum Value)

Plate Voltage	330	volts
Grid Voltage, Positive-bias value	0	volts
Plate Dissipation	0.55	watt

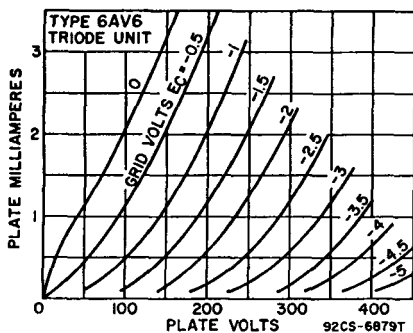

AVERAGE DIODE CHARACTERISTICS
HALF-WAVE RECTIFICATION-SINGLE DIODE UNIT

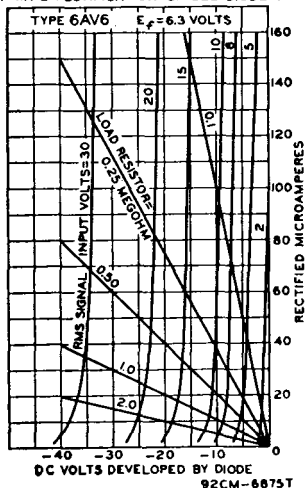

CHARACTERISTICS

Plate Voltage	100	250	volts
Grid Voltage	-1	-2	volts
Amplification Factor	100	100	
Plate Resistance	80000	62500	ohms
Transconductance	1250	1600	μmhos
Plate Current	0.50	1.2	mA

Diode Units

MAXIMUM RATING (Design-Maximum Value)

Plate Current (Each Unit)	1	mA
---------------------------------	---	----

The two diode plates are placed around a cathode, the sleeve of which is common to the triode unit. Each diode plate has its own base pin. Diode biasing of the triode unit is not recommended.

Installation and Application

The triode unit of the 6AV6 is recommended for use only in resistance-coupled circuits. Refer to the Resistance-Coupled Amplifier section for typical operating conditions. Grid bias for the triode unit of the 6AV6 may be obtained from a fixed source, such as a fixed-voltage tap on the dc power supply, or from a cathode-bias resistor. It should not be obtained by the diode-biasing method because of the probability of plate-current cutoff, even with relatively small signal voltages applied to the diode circuit.

Refer to chart at end of section.

6AV11

Refer to chart at end of section.

6AW8

6AW8A

8AW8A

**HIGH-MU TRIODE—
SHARP-CUTOFF PENTODE**

Miniature type used in television receiver applications. The pentode unit is used as an if amplifier, video amplifier, agc amplifier, or reactance tube. The triode unit is used in low-frequency oscillator, sync-separator, sync-clipper, and phase-splitter circuits. Outlines section, 6E; requires miniature 9-contact socket. Type 8AW8A is identical with type 6AW8A except for heater ratings.

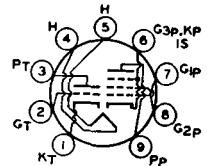
**9DX**

	6AW8A	8AW8A	
Heater Voltage (ac/dc)	6.3	8.4	volts
Heater Current	0.6	0.45	ampere
Heater Warm-up Time (Average)	11	11	seconds
Heater-Cathode Voltage:			
Peak value	±200 max	±200 max	volts
Average value	100 max	100 max	volts
Direct Interelectrode Capacitances:			
Triode Unit:			
Grid to Plate	2.2	2.2	pF
Grid to Cathode, Pentode Cathode, Pentode Grid No.3, Internal Shield, and Heater	3.2	3.4	pF
Plate to Cathode, Pentode Cathode, Pentode Grid No.3, Internal Shield, and Heater	1.8	3	pF
Pentode Unit:			
Grid No.1 to Plate	0.06 max	0.05 max	pF
Grid No.1 to Cathode, Heater, Grid No.2, Grid No.3, and Internal Shield	10	10	pF
Plate to Cathode, Heater, Grid No.2, Grid No.3, and Internal Shield	3.6	4.5	pF
Pentode Grid No.1 to Triode Plate	0.008 max	0.005 max	pF
Pentode Plate to Triode Plate	0.15 max	0.025 max	pF

■ With external shield connected to pins 4 and 5.

Class A₁ Amplifier**MAXIMUM RATINGS (Design-Maximum Values)**

	Triode Unit	Pentode Unit	
Plate Voltage	330	330	volts
Grid-No.2 (Screen-Grid) Supply Voltage	—	330	volts
Grid-No.2 Voltage	—	See curve page 300	volts
Grid-No.1 (Control-Grid) Voltage, positive-bias value	0	0	volts
Plate Dissipation	1.1	3.75	watts
Grid-No.2 Input:			
For grid-No.2 voltages up to 165 volts	—	1.1	watts
For grid-No.2 voltages between 165 and 330 volts	—	See curve page 300	

CHARACTERISTICS

Plate Supply Voltage	200	150	volts
Grid-No.2 Supply Voltage	—	150	volts
Grid-No.1 Voltage	-2	—	volts
Cathode-Bias Resistor	—	150	ohms
Amplification Factor	70	—	

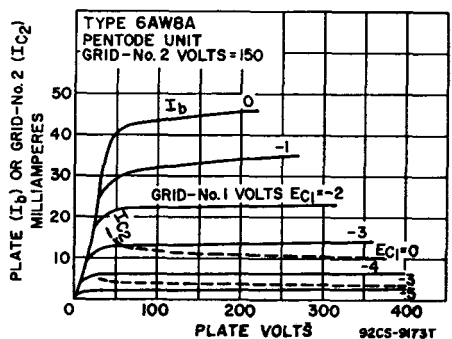
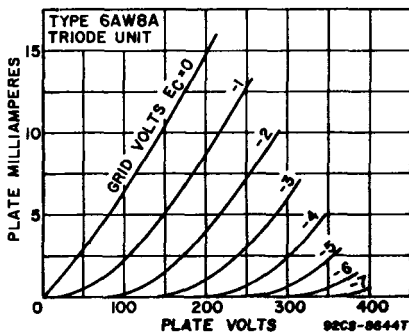

Plate Resistance (Approx.)	—	0.2	megohm
Transconductance	4000	9500	μmhos
Plate Current	4	15	mA
Grid-No.2 Current	—	3.5	mA
Grid-No.1 Voltage (Approx.) for plate current of 20 μA	—5	—8	volts

MAXIMUM CIRCUIT VALUES

Grid-No.1-Circuit Resistance:			
For fixed-bias operation	0.5	0.25	megohm
For cathode-bias operation	1	1	megohm

HALF-WAVE VACUUM RECTIFIER

6AX3

12AX3, 17AX3

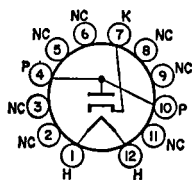

12BL

Duodecar type used as damper tube in horizontal-deflection circuits of television receivers. Outlines section, 8C; requires 12-contact socket. Socket terminals 5, 6, 8, and 9 should not be used as tie points. This tube, like other power-handling tubes, should be adequately ventilated. Types 12AX3 and 17AX3 are identical with type 6AX3 except for heater ratings.

	6AX3	12AX3	17AX3	
Heater Voltage (ac/dc)	6.3	12.6	16.8	volts
Heater Current	1.2	0.6	0.45	amperes
Heater Warm-up Time (Average)	—	11	11	seconds
Direct Interelectrode Capacitances:				
Plate to Cathode and Heater			5.5	pF
Cathode to Plate and Heater			7.5	pF
Heater to Cathode			2.8	pF

Damper Service

For operation in a 525-line, 30-frame system

MAXIMUM RATINGS (Design-Maximum Values)

Peak Inverse Plate Voltage#		5000	volts
Peak Plate Current		1000	mA
Average Plate Current		165	mA
Plate Dissipation		5.3	watts
Heater-Cathode Voltage:			
Peak value	+300	—5000	volts
Average value	+100	—900	volts

CHARACTERISTIC

Tube Voltage Drop for plate current of 250 mA 32 volts
 # Pulse duration must not exceed 15% of a horizontal scanning cycle (10 microseconds).

Refer to chart at end of section.

6AX4GT

HALF-WAVE VACUUM RECTIFIER

6AX4GTB

12AX4GTB, 17AX4GTA

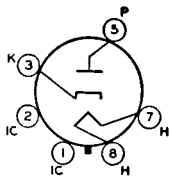

4CG

Glass octal type used as damper tube in horizontal-deflection circuits of color and black-and-white television receivers. Outlines section, 13D; requires octal socket. May be supplied with pin No. 1 omitted. Socket terminals 1, 2, 4, and 6 should not be used as tie points. This tube, like other power-handling tubes, should be adequately ventilated. Types 12AX4GTB and 17AX4GTA are identical with type 6AX4GTB except for heater ratings.

	6AX4-GTB	12AX4-GTB	17AX4-GTA	
Heater Voltage (ac/dc)	6.3	12.6	16.8	volts
Heater Current	1.2	0.6	0.45	amperes
Heater Warm-up Time (Average)	—	11	11	seconds
Direct Interelectrode Capacitances (Approx.):				
Cathode to Plate and Heater			8.5	pF
Plate to Cathode and Heater			5	pF
Heater to Cathode			4	pF

Damper Service

For operation in a 525-line, 30-frame system

MAXIMUM RATINGS (Design-Maximum Values)

Peak Inverse Plate Voltage#	5000	volts
Peak Plate Current	1000	mA
Average Plate Current	165	mA
Plate Dissipation	5.3	watts
Heater-Cathode Voltage:		
Peak value	+300	—5000
Average value	+100	—900
		volts
		volts

CHARACTERISTIC, Instantaneous Value

Tube Voltage Drop for plate current of 250 mA	32	volts
# Pulse duration must not exceed 15% of a horizontal scanning cycle (10 microseconds).		

6AX5GT

FULL-WAVE VACUUM RECTIFIER

Glass octal type used in power supplies of radio equipment having moderate dc requirements. Outlines section, 13D; requires octal socket. This type may be supplied with pin No. 1 omitted. This tube, like other power-handling tubes, should be adequately ventilated. Heater: volts (ac), 6.3; amperes, 1.2.

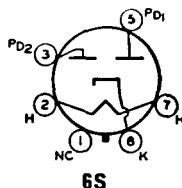

Full-Wave Rectifier

MAXIMUM RATINGS (Design-Center Values)

Peak Inverse Plate Voltage	1250	volts
Peak Plate Current (Per Plate)	375	mA
Hot-Switching Transient Plate Current:		
For duration of 0.2 second maximum	2.6	amperes
AC Plate Supply Voltage (Per Plate, rms)	See Rating Chart	
Average Output Current (Per Plate, rms)	See Rating Chart	
Peak Heater-Cathode Voltage	±450	volts

TYPICAL OPERATION WITH CAPACITOR INPUT TO FILTER

AC Plate-to-Plate Supply Voltage (rms)	700	900	volts
Filter Input Capacitor*	10	10	μF
Effective Plate-Supply Impedance Per Plate	50	105	ohms
DC Output Voltage at Input to Filter (Approx.):			
At half-load current of	{ 62.5 mA	395	—
At full-load current of	{ 40 mA	—	540
	{ 125 mA	350	—
	{ 80 mA	—	490
Voltage Regulation (Approx.):			
Half-load to full-load current	45	50	volts

TYPICAL OPERATION WITH CHOKE INPUT TO FILTER

AC Plate-to-Plate Supply Voltage (rms)	700	900	volts
Filter Input Choke	10#	10##	henries
DC Output Voltage at Input to Filter (Approx.):			
At half-load current of	{ 75 mA	270	—
At full-load current of	{ 62.5 mA	—	365
	{ 150 mA	250	—
	{ 125 mA	—	350

RATING CHART

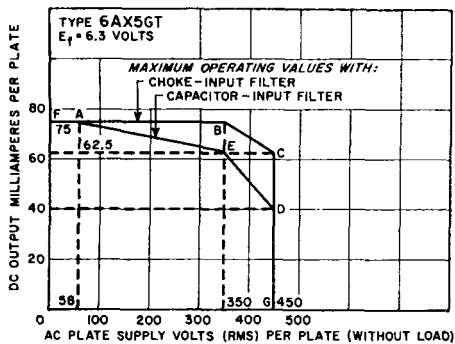

Voltage Regulation (Approx.):

Half-load to full-load current 20 15 volts

* Higher values of capacitance than indicated may be used but the effective plate-supply impedance may have to be increased to prevent exceeding the maximum rating for hot-switching transient plate current.

This value is adequate to maintain optimum regulation provided the load current is not less than 30 mA. For load currents less than 30 mA, a larger value of inductance is required for optimum regulation.

This value is adequate to maintain optimum regulation provided the load current is not less than 35 mA. For load currents less than 35 mA, a larger value of inductance is required for optimum regulation.

Refer to chart at end of section.

6AX8

Refer to chart at end of section.

6AY3

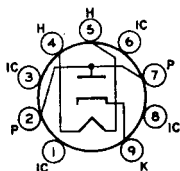

9HP

Socket terminals 1, 3, 6, and 8 should not be used as tie points. It is especially important that these tubes, like other power-handling tubes, be adequately ventilated. Types 12AY3A and 17AY3A are identical with type 6AY3B except for heater ratings.

HALF-WAVE VACUUM RECTIFIER

6AY3B

12AY3A, 17AY3A

Novar type used as damper tube in horizontal-deflection circuits of black-and-white television receivers.

Outlines section, 30B; requires novar 9-contact socket.

	6AY3B	12AY3A	17AY3A	
Heater Voltage (ac/dc)	6.3	12.6	16.8	volts
Heater Current	1.2	0.6	0.45	amperes
Heater Warm-up Time (Average)	—	11	11	seconds
Direct Interelectrode Capacitances (Approx.):				
Plate to Cathode and Heater			6.5	pF
Cathode to Plate and Heater			9	pF
Heater to Cathode			2.8	pF

Damper Service

For operation in a 525-line, 30-frame system

MAXIMUM RATINGS (Design-Maximum Values)

Peak Inverse Plate Voltage#	5000	volts	
Peak Plate Current	1100	mA	
Average Plate Current	175	mA	
Plate Dissipation	6.5	watts	
Heater-Cathode Voltage:			
Peak value	+800	-5000	volts
Average value	+100	-900	volts

CHARACTERISTIC, Instantaneous Value

Tube Voltage Drop for plate current of 350 mA 32 volts

Pulse duration must not exceed 15% of a horizontal scanning cycle (10 microseconds).

Refer to chart at end of section.

6AY11

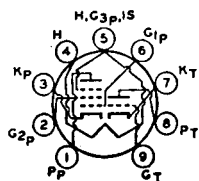

9ED

MEDIUM-MU TRIODE— SHARP-CUTOFF PENTODE

6AZ8

Miniature type used in color and black-and-white television receiver applications. The pentode unit is used as an if amplifier, video amplifier, agc amplifier, or reactance tube. The triode unit is used in low-frequency oscillator, sync-separator, sync-clipper, and phase-splitter circuits. Outlines section, 6B; requires miniature 9-contact socket.

Heater Voltage (ac/dc)	6.3	volts
Heater Current	0.45	ampere
Heater-Cathode Voltage:*		
Peak value	±200 max	volts
Average value	100 max	volts

Direct Interelectrode Capacitances:

Triode Unit:		
Grid to Plate	1.7	pF
Grid to Cathode, Heater, Pentode Grid No.3, and Internal Shield	2	pF
Plate to Cathode, Heater, Pentode Grid No.3, and Internal Shield	1.7	pF
Pentode Unit:		
Grid No.1 to Plate	0.02 max	pF
Grid No.1 to Cathode, Heater, Grid No.2, Grid No.3, and Internal Shield	6.5	pF
Plate to Cathode, Heater, Grid No.2, Grid No.3, and Internal Shield	2.2	pF
Triode Grid to Pentode Plate	0.027 max	pF
Pentode Grid No.1 to Triode Plate	0.020 max	pF
Pentode Plate to Triode Plate	0.045 max	pF

* The heater-cathode voltage of the pentode unit should not exceed the value of the operating cathode bias. Grid No.3 will be made negative with respect to cathode if this value is exceeded, and thus possibly cause a change in tube characteristics.

Class A₁ Amplifier

MAXIMUM RATINGS (Design-Center Values)

	Triode Unit	Pentode Unit	
Plate Voltage	300	300	volts
Grid-No.2 (Screen-Grid) Supply Voltage	—	300	volts
Grid-No.2 Voltage	—	See curve page 300	volts
Grid-No.1 (Control-Grid) Voltage, Positive-bias value	0	0	volts
Plate Dissipation	2.6	2	watts
Grid-No.2 Input:			
For grid-No.2 voltages up to 150 volts	—	0.5	watt
For grid-No.2 voltages between 150 and 300 volts	—	See curve page 300	

CHARACTERISTICS

	Triode Unit	Pentode Unit	
Plate Supply Voltage	200	200	volts
Grid-No.2 Voltage	—	150	volts
Grid-No.1 Voltage	—6	—	volts
Cathode-Bias Resistor	—	180	ohms
Amplification Factor	19	—	
Plate Resistance (Approx.)	5750	300000	ohms
Transconductance	3300	6000	μ mhos
Plate Current	13	9.5	mA
Grid-No.2 Current	—	3	mA
Grid-No.1 Voltage (Approx.) for plate current of 10 μ A	—19	—	volts
Grid-No.1 Voltage (Approx.) for transconductance of 100 μ mhos	—	—12.5	volts

MAXIMUM CIRCUIT VALUES

Grid-No.1-Circuit Resistance:*			
For fixed-bias operation	0.5	0.25	megohm
For cathode-bias operation	1	1	megohm

* If either unit is operating at maximum rated conditions, grid-No.1-circuit resistance for both units should not exceed the stated values.

6B4G Refer to chart at end of section.

6B5 Refer to chart at end of section.

6B6G Refer to chart at end of section.

6B7
6B7S Refer to chart at end of section.

6B8
6B8G Refer to chart at end of section.

6B10

8B10

**TWIN DIODE—
MEDIUM-MU TWIN TRIODE**

Duodecar type used in television receiver applications; diode units are used in horizontal-phase-detector circuits, and triode units are used in horizontal-oscillator circuits. Outlines section, 8A; requires duodecar 12-contact socket. Type 8B10 is identical with type 6B10 except for heater ratings.

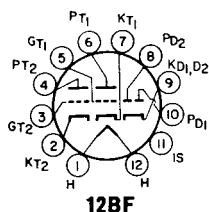

12BF

	6B10	8B10	
Heater Voltage (ac/dc)	6.3	8.5	volts
Heater Current	0.6	0.45	ampere
Heater Warm-up Time (Average)	11	11	seconds
Heater-Cathode Voltage:			
Peak value	±200 max	±200 max	volts
Average value	100 max	100 max	volts

Class A₁ Amplifier (Each Triode Unit)

MAXIMUM RATING (Design-Maximum Value)			
Plate Voltage		330	volts
Average Cathode Current		20	mA
Plate Dissipation		3	watts

CHARACTERISTICS

Plate Voltage		250	volts
Grid Voltage		-8	volts
Amplification Factor		18	
Plate Resistance (Approx.)		7200	ohms
Transconductance		2500	μmhos
Plate Current		10	mA
Grid Voltage (Approx.) for plate current of 50 μA		-20	volts

MAXIMUM CIRCUIT VALUES

Grid-Circuit Resistance:			
For fixed-bias operation		0.25	megohm
For cathode-bias operation		1	megohm

Diode Units (Each Unit)

MAXIMUM RATING (Design-Maximum Value)			
Plate Current		5	mA

CHARACTERISTIC, Instantaneous Value

Tube Voltage Drop for plate current of 20 mA		5	volts
----------------------------------------------------	--	---	-------

Refer to chart at end of section.

6BA3

For replacement use type 6BA6/EF93.

6BA6

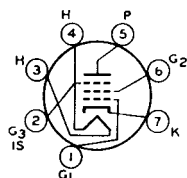

7BK

REMOTE-CUTOFF PENTODE

6BA6/EF93

12BA6

Miniature types used as rf amplifiers in standard broadcast and FM receivers, as well as in wide-band, high-frequency applications. The low value of grid-No.1-to-plate capacitance minimizes regenerative effects, while the high transconductance makes possible high signal-to-noise ratio. Outlines section, 5C; require miniature 7-contact socket. Type 12BA6 is identical with type 6BA6/EF93 except for heater ratings.

	6BA6/EF93	12BA6	
Heater Voltage (ac/dc)	6.3	12.6	volts
Heater Current	0.3	0.15	ampere
Heater-Cathode Voltage:			
Peak value	±200 max	±200 max	volts
Average value	100 max	100 max	volts
Direct Interelectrode Capacitances:			
Grid No.1 to Plate		0.0035 max	pF
Grid No.1 to Cathode, Heater, Grid No.2, Grid No.3, and Internal Shield		5.5	pF
Plate to Cathode, Heater, Grid No.2, Grid No.3, and Internal Shield		5*	pF

* This value is 5.5 pF with external shield connected to cathode.

Class A₁ Amplifier

MAXIMUM RATINGS (Design-Maximum Values)

Plate Voltage	330	volts
Grid-No.3 (Suppressor-Grid) Voltage, Positive value	0	volts
Grid-No.2 (Screen-Grid) Voltage	See curve page 300	
Grid-No.2 Supply Voltage	330	volts
Plate Dissipation	3.4	watts
Grid-No.2 Input:		
For grid-No.2 voltages up to 165 volts	0.7	watt
For grid-No.2 voltages between 165 and 330 volts	See curve page 300	
Grid-No.1 (Control-Grid) Voltage:		
Negative-bias value	55	volts
Positive-bias value	0	volts

CHARACTERISTICS

Plate Supply Voltage	100	250	volts
Grid No.3 and Internal Shield	Connected to cathode at socket		
Grid-No.2 Supply Voltage	100	100	volts
Cathode-Bias Resistor	68	68	ohms
Plate Resistance (Approx.)	0.25	1	megohm
Transconductance	4300	4400	μ mhos
Plate Current	10.8	11	mA
Grid-No.2 Current	4.4	4.2	mA
Grid-No.1 Voltage (Approx.) for transconductance of 40 μ mhos	-20	-20	volts

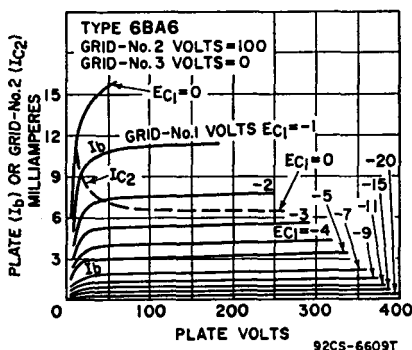

Installation and Application

Control-grid bias variation is effective in changing the volume of the receiver. To obtain adequate volume control, an available grid-No.1-bias voltage of approximately 50 volts is required. The exact value depends upon the circuit design and operating conditions. This voltage may be obtained, depending on the receiver requirements, from a potentiometer across a fixed supply voltage, from a variable cathode-bias resistor, from the avc system, or from a combination of these methods.

The grid-No.2 (screen-grid) voltage may be obtained from a potentiometer or bleeder circuit across the B-supply source, or through a dropping resistor from the plate supply. The use of series resistors for obtaining satisfactory control of grid-No.2 voltage in the case of four-electrode tubes is usually impossible because of secondary-emission phenomena. In the 6BA6, however, because grid No.3 practically removes these effects, it is practical to obtain grid-No.2 voltage through a series-dropping resistor from the plate supply or from some high intermediate voltage, provided the source does not exceed the plate-supply voltage. With this method, the grid-No.2-to-cathode voltage will fall off very little from minimum to maximum value of the resistor controlling cathode bias. In some cases, it may actually rise. This rise of grid-No.2-to-cathode voltage above the normal maximum value is allowable because both the grid-No.2 current and the plate current are reduced simultaneously by a sufficient amount to prevent damage to the tube. It should be recognized that, in general, the series-

resistor method of obtaining grid-No.2 voltage from a higher voltage supply necessitates the use of the variable cathode-resistor method of controlling volume in order to prevent too high a voltage on grid No.2. When grid-No.2 and control-grid voltage are obtained in this manner, the remote "cutoff" advantage of the 6BA6 can be fully realized. However, it should be noted that the use of a resistor in the grid-No.2 circuit has an effect on the change in plate resistance with variation in grid-No.3 (suppressor-grid) voltage in case grid No.3 is utilized for control purposes.

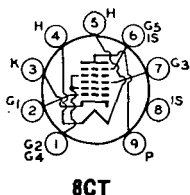

PENTAGRID CONVERTER

6BA7

Miniature type used as converter in AM and FM receivers. Outlines section, 6E; requires miniature 9-contact socket.

Heater Voltage	6.3	volts
Heater Current	0.3	ampere
Peak Heater-Cathode Voltage	±90	volts
Direct Interelectrode Capacitances:		
Grid No. 3 to All Other Electrodes	9.5	pF
Plate to All Other Electrodes	8.3	pF
Grid No. 1 to All Other Electrodes	6.7	pF
Grid No. 3 to Plate	0.19 max	pF
Grid No. 3 to Grid No. 1	0.1 max	pF
Grid No. 1 to Plate	0.05 max	pF
Grid No. 1 to All Other Electrodes, except Cathode	3.4	pF
Grid No. 1 to Cathode	3.3	pF
Cathode to All Other Electrodes except Grid No. 1	4	pF

Converter Service

MAXIMUM RATINGS (Design-Center Values)

Plate Voltage	300	volts
Grid-No.5-and-Internal-Shield Voltage ^a	0	volts
Grids-No.2-and-No.4 (Screen-Grid) Voltage	100	volts
Grids-No.2-and-No.4 Supply Voltage	300	volts
Plate Dissipation	2	watts
Grids-No.2-and-No.4 Input	1.5	watts
Total Cathode Current	22	mA
Grid-No.3 Voltage:		
Negative-bias value	100	volts
Positive-bias value	0	volts

CHARACTERISTICS (Separate Excitation)*

Plate Voltage	100	250	volts
Grid No.5 and Internal Shield ^a	Connected directly to ground		
Grids-No.2-and-No.4 (Screen-Grid) Voltage	100	100	volts
Grid-No.3 (Control-Grid) Voltage	-1	-1	volt
Grid-No.1 (Oscillator-Grid) Resistor	20000	20000	ohms
Plate Resistance (Approx.)	0.5	1	megohm
Conversion Transconductance	900	950	μmhos
Conversion Transconductance (Approx.)**	3.5	3.5	μmhos
Plate Current	3.6	3.8	mA
Grids-No.2-and-No.4 Current	10.2	10	mA
Grid-No.1 Current	0.35	0.35	mA
Total Cathode Current	14.2	14.2	mA

NOTE: The transconductance between grid No.1 and grids No.2 and No.4 connected to plate (not oscillating) is approximately 8000 μmhos under the following conditions: signal applied to grid No.1 at zero bias; grids No.2 and No.4 and plate at 100 volts; grid No.3 grounded. Under the same conditions, the plate current is 32 milliamperes, and the amplification factor is 16.5.

* The characteristics shown with separate excitation correspond very closely with those obtained in a self-excited oscillator circuit operating with zero bias.

** With grid-No.3 bias of -20 volts.

^a Internal Shield (pins No.6 and No.8) connected directly to ground.

6BA8A

8BA8A

MEDIUM-MU TRIODE— SHARP-CUTOFF PENTODE

Miniature type used in color and black-and-white television receivers. The pentode unit is used as a video amplifier, an age amplifier, or a reactance tube. The triode unit is used in low-frequency oscillator and phase-splitter circuits. **Outlines section, 6E**; requires miniature 9-contact socket. Type 8BA8A is identical with type 6BA8A except for the heater ratings.

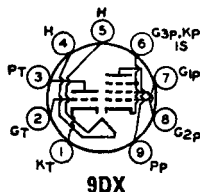

	6BA8A	8BA8A	
Heater Voltage (ac/dc)	6.3	8.4	volts
Heater Current	0.3	0.45	ampere
Heater Warm-up Time (Average)	11	—	seconds
Heater-Cathode Voltage:			
Peak value	±200 max	±200 max	volts
Average value	100 max	100 max	volts
Direct Interelectrode Capacitances (Approx.):			
Triode Unit:			
Grid to Plate	2.2	2.2	pF
Grid to Cathode and Heater	2.5	2.7	pF
Plate to Cathode and Heater	0.4	1.9	pF
Pentode Unit:			
Grid No.1 to Plate	0.06	0.05	pF
Grid No.1 to Cathode, Heater, Grid No.2, Grid No.3, and Internal Shield	10	10	pF
Plate to Cathode, Heater, Grid No.2, Grid No.3, and Internal Shield	3.6	4.5	pF
Triode Grid to Pentode Plate	0.016	0.006	pF
Pentode Grid No.1 to Triode Plate	0.006	0.003	pF
Pentode Plate to Triode Plate	0.15	0.023	pF

Class A₁ Amplifier

MAXIMUM RATINGS (Design-Center Values)

	Triode Unit	Pentode Unit	
Plate Voltage	300	300	volts
Grid-No.2 (Screen-Grid) Supply Voltage	—	300	volts
Grid-No.2 Voltage	—	See curve page 300	
Grid-No.1 (Control-Grid) Voltage:			
Negative-bias value	—	-50	volts
Positive-bias value	—	0	volts
Plate Dissipation	2	3.25	watts
Grid-No.2 Input:			
For grid-No.2 voltages up to 150 volts	—	1	watt
For grid-No.2 voltages between 150 and 300 volts	—	See curve page 300	

CHARACTERISTICS

Plate-Supply Voltage	200	200	volts
Grid-No.2 Supply Voltage	—	150	volts
Grid-No.1 Voltage	-8	—	volts
Cathode-Bias Resistor	—	180	ohms
Amplification Factor	18	—	
Plate Resistance (Approx.)	6700	40000	ohms
Transconductance	2700	9000	μmhos
Plate Current	8	13	mA
Grid-No.2 Current	—	3.5	mA
Grid-No.1 Voltage (Approx.) for plate current of 10 μA	-16	-10	volts

MAXIMUM CIRCUIT VALUES

Grid-No.1-Circuit Resistance:			
For fixed-bias operation	0.5	0.25	megohm
For cathode-bias operation	1	1	megohm

6BA11

8BA11

TRIODE—TWIN PENTODE

Duodecar type used as vertical-deflection oscillator and for combined sync-age applications in color and black-and-white television receivers. **Outlines section, 8B**; requires duodecar 12-contact socket. Type 8BA11 is identical with type 6BA11 except for the heater ratings.

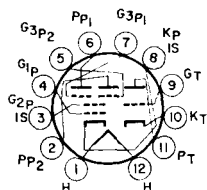

12ER

	6BA11	8BA11	
Heater Voltage (ac/dc)	6.3	8.4	volts
Heater Current	0.6	0.45	amperes
Heater Warm-up Time	11	11	seconds
Heater-Cathode Voltage:			
Peak value	±200 max	±200 max	volts
Average value	100 max	100 max	volts
Direct Interelectrode Capacitances:			
Triode Unit:			
Grid to Plate		2	pF
Grid to Cathode and Heater		2	pF
Plate to Cathode, Heater, and Internal Shield		1.9	pF
Pentode Unit			
Grid No.3 to Plate (Each Unit)		2	pF
Grid No.3 to all Other Electrodes (Each Grid)		3.6	pF
Grid No.1 to all Other Electrodes)		6	pF
Plate to all Other Electrodes (Each Plate)		3	pF
Grid No.3 of Pentode 1 to Grid No.3 of Pentode 2		0.026 max	pF

Triode Unit as Class A₁ Amplifier

MAXIMUM RATINGS (Design-Maximum Values)

Plate Voltage	300	volts
Average Cathode Current	20	mA
Plate Dissipation	1.5	watts

CHARACTERISTICS

Plate Voltage	250	volts
Grid Voltage	-11	volts
Amplification Factor	18	
Transconductance	1800	μmhos
Plate Current	5	mA
Grid Voltage (Approx.) for plate current of 100 μA	-18	volts

MAXIMUM CIRCUIT VALUES

Grid-Circuit Resistance:		
For fixed-bias operation	0.25	megohm
For cathode-bias operation	1	megohm

Pentode Unit as Class A₁ Amplifier

MAXIMUM RATINGS (Design-Maximum Values)

Plate Voltage (Each Unit)	300	volts
Grid-No.3 (Suppressor-Grid) Voltage (Each Unit):		
Peak positive value	50	volts
DC negative value	50	volts
DC positive value	3	volts
Grid-No.2 (Screen-Grid) Voltage	150	volts
Grid-No.1 (Control-Grid) Voltage, Negative bias value	50	volts
Cathode Current	12	mA
Plate Dissipation (Each Unit)	1.1	watts
Grid-No.2 Input	0.75	watt

CHARACTERISTICS (With Both Units Operating)■

Plate Voltage (Each Unit)	100	100	volts
Grid-No.3 Voltage (Each Unit)	-10	0	volts
Grid-No.2 Voltage	67.5	67.5	volts
Grid-No.1 Voltage	*	*	volts
Plate Current (Each Unit)	0	2.5	mA
Grid-No.2 Current	7	4.4	mA

CHARACTERISTICS (With One Unit Operating) †

Plate Voltage	100	100	volts
Grid-No.3 Voltage	0	0	volts
Grid-No.2 Voltage	67.5	67.5	volts
Grid-No.1 Voltage	0	*	volts
Grid-No.3 Transconductance	—	450	μmhos
Grid-No.1 Transconductance	1700	—	μmhos
Plate Current	—	2.5	mA
Grid-No.2 Voltage (Approx.) for plate current of 100 μA	—	3.2	volts
Grid-No.1 Voltage (Approx.) for plate current of 100 μA	2.3	—	volts

MAXIMUM CIRCUIT VALUES

Grid-No.3-Circuit Resistance (Each Unit)	0.5	megohm
Grid-No.1-Circuit Resistance	0.5	megohm

* Adjusted to provide a dc grid-No.1 current of 100 microamperes.

† With plate and grid No.3 of the other unit connected to ground.

■ Voltages and plate current apply to each section.

6BC4**MEDIUM-MU TRIODE**

Miniature type used as an rf amplifier in the cathode-drive circuits of uhf television tuners covering the frequency range of 470 to 890 MHz. Outlines section, 6A; requires miniature 9-contact socket.

Heater Voltage (ac/dc)	6.3	volts
Heater Current	0.225	ampere
Peak Heater-Cathode Voltage	±75 max	volts
Direct Interelectrode Capacitances (Approx.):		
Grid to Plate	1.6	pF
Grid to Heater and Cathode	2.9	pF
Plate to Heater and Cathode	0.26	pF
Heater to Cathode	2.7	pF

**9DR****Class A₁ Amplifier****MAXIMUM RATINGS (Design-Center Values)**

Plate Voltage	250	volts
Cathode Current	25	mA
Plate Dissipation	2.5	watts

CHARACTERISTICS

Plate Supply Voltage	150	volts
Cathode-Bias Resistor	100	ohms
Amplification Factor	48	
Plate Resistance (Approx.)	4800	ohms
Transconductance	10000	μmhos
Plate Current	14.5	mA
Grid Voltage (Approx.) for plate current of 10 μA	-10	volts

MAXIMUM CIRCUIT VALUES

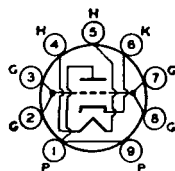
Grid-Circuit Resistance:		
For fixed-bias operation		Not recommended
For cathode-bias operation	0.5	megohm

6BC5

Refer to chart at end of section.

6BC5/6CE5**SHARP-CUTOFF PENTODE****3BC5/3CE5**

Miniature type used in compact radio equipment as an rf or if amplifier at frequencies up to 400 MHz. Outlines section, 5C; requires miniature 7-contact socket. For typical operation as resistance-coupled amplifier, refer to Resistance-Coupled Amplifier section. Type 3BC5/3CE5 is identical with type 6BC5/6CE5 except for heater ratings.

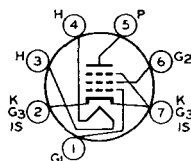
**7BD**

	3BC5/3CE5	6BC5/6CE5	
Heater Voltage (ac/dc)	3.15	6.3	volts
Heater Current	0.6	0.3	ampere
Heater Warm-up Time (Average)	11	—	seconds
Heater-Cathode Voltage:			
Peak value	±200 max	±90 max	volts
Average value	100 max	—	volts
Direct Interelectrode Capacitances:			
Pentode Connection:			
Grid No.1 to Plate		0.030 max	pF
Grid No.1 to Cathode, Heater, Grid No.2, Grid No.3, and Internal Shield		6.5	pF
Plate to Cathode, Heater, Grid No.2, Grid No.3, and Internal Shield		1.8	pF
Triode Connection:*			
Grid No.1 to Plate and Grid No.2		2.5	pF
Grid No.1 to Cathode, Heater, Grid No.3, and Internal Shield ..		3.9	pF
Plate and Grid No.2 to Cathode, Heater, Grid No.3, and Internal Shield		3	pF

* Grid No.2 connected to plate.

Class A₁ Amplifier

MAXIMUM RATINGS (Design-Center Values)

	Triode Connection*	Pentode Connection	
Plate Voltage	300	300	volts
Grid-No.2 (Screen-Grid) Supply Voltage	—	300	volts
Grid-No.2 Voltage	—	See curve page 300	
Grid-No.1 (Control-Grid) Voltage, Positive-bias value.	0	0	volts
Plate Dissipation	2.5	2	watts
Grid-No.2 Input:			
For grid-No.2 voltages up to 150 volts	—	0.5	watt
For grid-No.2 voltages between 150 and 300 volts.	—	See curve page 300	

CHARACTERISTICS

	Triode Connection*		Pentode Connection			
Plate Supply Voltage	180	250	100	125	250	volts
Grid-No.2 Supply Voltage	—	—	100	125	150	volts
Cathode-Bias Resistor	330	820	180	100	180	ohms
Amplification Factor	42	40	—	—	—	
Plate Resistance (Approx.)	0.006	0.009	0.6	0.5	0.8	megohm
Transconductance	6000	4400	4900	6100	5700	μmhos
Plate Current	8	6	4.7	8	7.5	mA
Grid-No.2 Current	—	—	1.4	2.4	2.1	mA
Grid-No.1 Voltage (Approx.) for plate current of 10 μA	—	—	-5	-6	-8	volts

* Grid No.2 connected to plate.

Refer to chart at end of section.

6BC7

For replacement use type 6BC8/6BZ8.

6BC8

6BC8/6BZ8

4BC8

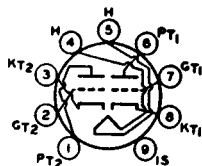

9AJ

MEDIUM-MU TWIN TRIODE

Miniature type used as a cascode amplifier in vhf television tuners and in push-pull cathode-drive rf amplifiers. Outlines section, 6B; requires miniature 9-contact socket. Type 4BC8 is identical with type 6BC8/6BZ8 except for heater ratings.

	4BC8	6BC8/6BZ8	
Heater Voltage (ac/dc)	4.2	6.3	volts
Heater Current	0.6	0.4	ampere
Heater Warm-up Time (Average)	11	—	seconds
Heater-Cathode Voltage:			
Peak value	±200* max	±200* max	volts
Average value	100 max	100 max	volts
Direct Interelectrode Capacitances*:			
	Unit No.1	Unit No.2	
Grid to Plate	1.2	1.2	pF
Grid to Cathode, Heater, and Internal Shield	2.6	—	pF
Cathode to Grid, Heater, and Internal Shield	—	5.5	pF
Plate to Cathode, Heater, and Internal Shield	1.3	—	pF
Plate to Grid, Heater, and Internal Shield	—	2.4	pF
Plate to Cathode	—	0.12	pF
Heater to Cathode	2.8	2.8	pF
Plate of Unit No.1 to Plate of Unit No.2	—	0.02 max	pF
Plate of Unit No.2 to Plate and Grid of Unit No.1	—	0.04 max	pF

* Rating may be as high as 300 volts under cutoff conditions, when tube is used as a cascode amplifier, the two units are connected in series, and heater is negative with respect to cathode.

* With external shield connected to internal shield.

Class A₁ Amplifier (Each Unit)

MAXIMUM RATINGS (Design-Maximum Values)

Plate Voltage	250*	volts
Cathode Current	22	mA
Plate Dissipation	2.2	watts

CHARACTERISTICS

Plate Supply Voltage	150	volts
Cathode-Bias Resistor	220	ohms
Plate Resistance (Approx.)	5300	ohms
Amplification Factor	35	
Transconductance	6200	μmhos
Plate Current	10	mA
Grid Voltage (Approx.) for transconductance of 50 μmhos	-13	volts

MAXIMUM CIRCUIT VALUES

Grid-Circuit Resistance 0.5 megohm
 * Rating may be as high as 300 volts under cutoff conditions, when tube is used as a cascode amplifier, the two units are connected in series, and heater is negative with respect to cathode.

6BD4	Refer to chart at end of section.
6BD4A	
6BD6	Refer to chart at end of section.
6BD11	Refer to chart at end of section.
6BE3	For replacement use type 6BE3/6BZ3.

6BE3/6BZ3

12BE3,
17BE3/17BZ3

Duodecar type used as damper tube in horizontal-deflection circuits of color and black-and-white television receivers. Outlines section, 8D; requires duodecar 12-contact socket. Types 12BE3 and 17BE3/17BZ3 are identical with type 6BE3/6BZ3 except for heater ratings.

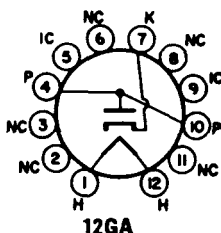
**HALF-WAVE
VACUUM RECTIFIER**

	6BE3/6BZ3	12BE3	17BE3/ 17BZ3	
Heater Voltage (ac/dc)	6.3	12.6	16.8	volts
Heater Current	1.2	0.6	0.46	ampere
Heater Warm-up Time (Average)	—	11	11	seconds
Direct Interelectrode Capacitances (Approx.):				
Plate to Cathode, and Heater			10	pF
Cathode to Heater, and Plate			8	pF
Heater to Cathode			3.4	pF

Damper Service

For operation in a 525-line, 30-frame system

MAXIMUM RATINGS (Design-Maximum Values)

Peak Inverse Plate Voltage#	5000	volts	
Peak Plate Current	1200	mA	
Average Plate Current	200	mA	
Plate Dissipation	6.5	watts	
Heater-Cathode Voltage:			
Peak value	+300	—5000	volts
Average value	+100	—900	volts

CHARACTERISTIC Instantaneous Value

Tube Voltage Drop for dc plate current of 350 mA	25	volts
--------------------------------------------------------	----	-------

Pulse duration must not exceed 15% of a horizontal scanning cycle (10 microseconds).

6BE6

12BE6

PENTAGRID CONVERTER

Miniature type used as converter in AM and FM receivers. Outlines section, 5C; requires miniature 7-contact socket. For general discussion of pentagrid types, see Frequency Conversion in Electron Tube Applications section. Type 12BE6 is identical with type 6BE6 except for heater ratings.

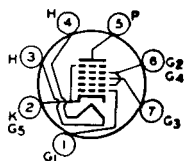
**7CH**

Heater Voltage (ac/dc)	6BE6	12BE6	
Heater Current	6.3	12.6	volts
	0.3	0.15	ampere

Heater-Cathode Voltage:			
Peak value	±200 max	±200 max	volts
Average value	100 max	100 max	volts
Direct Interelectrode Capacitances:			
	Unshielded	Shielded*	
Grid No.3 to Plate	0.30 max	0.25 max	pF
Grid No.3 to Grid No.1	0.15 max	0.15 max	pF
Grid No.1 to Plate	0.10 max	0.05 max	pF
Grid No.3 to All Other Electrodes	7	7	pF
Grid No.1 to All Other Electrodes	5.5	5.5	pF
Plate to All Other Electrodes	8.0	13.0	pF
Grid No.1 to Cathode and Grid No.5	3	3	pF
Cathode and Grid No.5 to All Other Electrodes except Grid No.1	15	20	pF

* With external shield connected to cathode and grid No.5.

Converter

MAXIMUM RATINGS (Design-Maximum Values)

Plate Voltage	330	volts
Grids-No.2-and-No.4 (Screen-Grid) Voltage	110	volts
Grids-No.2-and-No.4 Supply Voltage	330	volts
Cathode Current	15.5	mA
Plate Dissipation	1.1	watts
Grids-No.2-and-No.4 Input	1.1	watts
Grid-No.3 Voltage:		
Negative-bias value	55	volts
Positive-bias value	0	volts
Heater-Cathode Voltage:		
Peak value	200	volts
Average value	100	volts

TYPICAL OPERATION (Separate Excitation)*

Plate Voltage	100	250	volts
Grids-No.2-and-No.4 (Screen-Grid) Voltage	100	100	volts
Grid-No.1 (Oscillator-Grid) Voltage (rms)	10	10	volts
Grid-No.3 (Control-Grid) Voltage	-1.5	-1.5	volts
Grid-No.1 (Oscillator-Grid) Resistor	20000	20000	ohms
Plate Resistance (Approx.)	0.4	1	megohm
Conversion Transconductance	455	475	μmhos
Plate Current	2.6	2.9	mA
Grids-No.2-and-No.4 Current	7.0	6.8	mA
Grid-No.1 Current	0.5	0.5	mA
Cathode Current	10.1	10.2	mA
Grid-No.3 Voltage for conversion transconductance of 10 μmhos	-30	-30	volts

NOTE: The transconductance between grid No.1 and grids No.2 and No.4 connected to plate (not oscillating) is approximately 7250 μmhos under the following conditions: grids No.1 and No.3 at 0 volts; grids No.2 and No.4 and plate at 100 volts. Under the same conditions, the cathode current is 25 mA, and the amplification factor is 20. Grid-No.1 voltage (Approx.) for plate current of 10 μA is -11 volts.

* The characteristics shown with separate excitation correspond very closely with those obtained in a self-excited circuit operating with zero bias.

Installation and Application

Because of the special structural arrangement of the 6BE6, a change in signal-grid voltage produces little change in cathode current. Consequently, an rf voltage on the signal grid produces little modulation of the electron current flowing in the cathode circuit. This feature is important because it is desirable that the impedance in the cathode circuit should produce little degeneration or regeneration of the signal-frequency input and intermediate-frequency output. Another important feature is that, because signal-grid voltage has very little effect on the space charge near the cathode, changes in avc bias produce little change in oscillator transconductance and in the input capacitance of grid No.1. There is, therefore, little detuning of the oscillator by avc bias.

A typical self-excited oscillator circuit employing the 6BE6 is given in the Circuits section.

In the 6BE6 operation characteristics curves with self-excitation, E_k is the voltage across the oscillator-coil section between cathode and ground; E_g is the oscillator voltage between cathode and grid.

OPERATION CHARACTERISTICS WITH SELF-EXCITATION

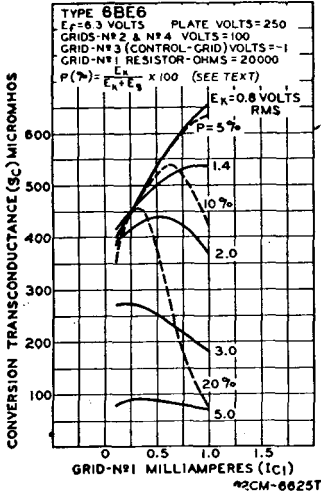

OPERATION CHARACTERISTICS WITH SEPARATE OSCILLATOR EXCITATION

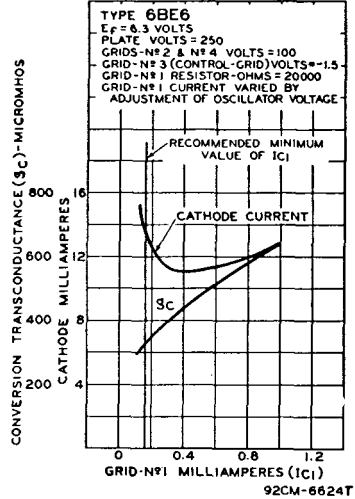

6BF5

Refer to chart at end of section.

6BF6

Refer to chart at end of section.

6BF11

BEAM POWER TUBE—SHARP-CUTOFF PENTODE

12BF11, 17BF11, 24BF11

Duodec type used as combined detector and amplifier tube in color and black-and-white television receivers. The dual-control, sharp-cutoff pentode unit is used as an FM detector and the beam power unit as an af output amplifier. Outlines section, 8C; requires duodec 12-contact socket. Types 12BF11, 17BF11 and 24BF11 are identical with type 6BF11 except for heater ratings.

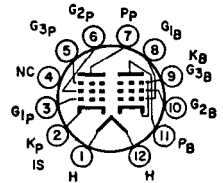

12EZ

	6BF11	12BF11	17BF11	24BF11	
Heater Voltage (ac/dc)	6.3	12.6	16.8	24.2	volts
Heater Current	1.2	0.6	0.45	0.315	amperes
Heater Warm-up Time (Average)	—	11	11	11	seconds
Heater-Cathode Voltage:					
Peak value	±200 max	±200 max	±200 max	±200 max	volts
Average value	100 max	100 max	100 max	100 max	volts
Direct Interelectrode Capacitances:					
Pentode Unit:					
Grid No.1 to Plate				0.36	pF
Grid No.3 to Plate				3.2	pF
Grid No.1 to Cathode, Heater, Grid No.2, Grid No.3, and Internal Shield				6.5	pF
Grid No.3 to Cathode, Heater, Grid No.1, Grid No.2, Plate, and Internal Shield				8	pF
Grid No.1 to Grid No.3				0.11	pF
Beam Power Unit:					
Grid No.1 to Plate				0.24	pF
Grid No.1 to Cathode, Heater, Grid No.2, Grid No.3, and Internal Shield				13	pF
Plate to Cathode, Heater, Grid No.2, Grid No.3, and Internal Shield				10	pF
Pentode Plate to Beam Power Plate				0.13	pF

Beam Power Unit as Class A₁ Amplifier

MAXIMUM RATINGS (Design-Maximum Values)

Plate Voltage	165	volts
Grid-No.2 (Screen-Grid) Voltage	150	volts
Average Cathode Current	65	mA
Plate Dissipation	6.5	watts
Grid-No.2 Input	1.8	watts

TYPICAL OPERATION

Plate Voltage	145	volts
Grid-No.2 Voltage	110	volts
Grid-No.1 (Control-Grid) Voltage	-6	volts
Peak AF Grid-No.1 Voltage	6	volts
Zero-Signal Plate Current	36	mA
Maximum-Signal Plate Current	40	mA
Zero-Signal Grid No.2 Current	3	mA
Maximum-Signal Grid-No.2 Current	9	mA
Plate Resistance (Approx.)	0.03	megohm
Transconductance	8600	μmhos

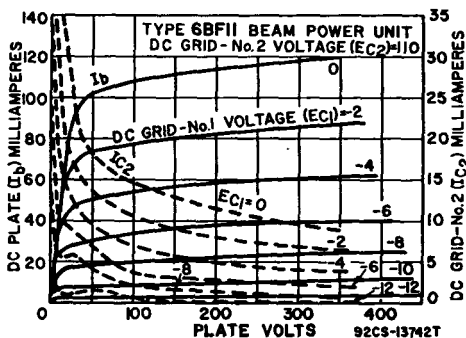

Load Resistance	3000	ohms
Total Harmonic Distortion	10	per cent
Maximum-Signal Power Output	2.4	watts

MAXIMUM CIRCUIT VALUES

Grid-No.1-Circuit Resistance:		
For fixed-bias operation	0.25	megohm
For cathode-bias operation	0.5	megohm

Pentode Unit as Class A₁ Amplifier

CHARACTERISTICS

Plate Supply Voltage	150	volts
Grid No.3 (Control-Grid)	Connected to negative end of cathode resistor	
Grid-No.2 (Screen-Grid) Supply Voltage	100	volts
Grid No.1 (Control Grid)	Connected to negative end of cathode resistor	
Cathode-Bias Resistor	560	ohms
Plate Resistance (Approx.)	0.15	megohm
Transconductance, Grid No.1 to Plate	1000	μmhos
Transconductance, Grid No.3 to Plate	400	μmhos
Plate Current	1.3	mA
Grid-No.2 Current	2	mA
Grid-No.1 Voltage (Approx.) for plate current of 10 μA	-4.5	volts
Grid-No.3 Voltage (Approx.) for plate current of 10 μA	-4.5	volts

Pentode Unit as FM Sound Detector

MAXIMUM RATINGS (Design-Maximum Values)

Plate Voltage	330	volts
Grid-No.3 Voltage	28	volts
Grid No.2 Supply Voltage	330	volts
Grid-No.2 Voltage	See curve page 300	
Grid-No.1 (Control-Grid) Voltage, Positive-bias value	0	volts
Plate Dissipation	1.7	watts
Grid-No.2 Input:		
For grid-No.2 voltages up to 165 volts	1.1	watts
For grid-No.2 voltages between 165 and 330 volts	See curve page 300	

MAXIMUM CIRCUIT VALUES

Grid-No.1-Circuit Resistance:

- For fixed-bias operation
- For cathode-bias operation

0.25 megohm
0.5 megohm

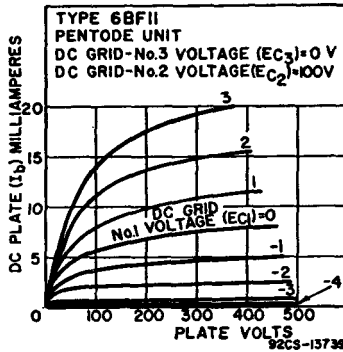

6BG6G
6BG6GA

Refer to chart at end of section.

6BH3

Refer to chart at end of section.

6BH3A

Refer to chart at end of section.

6BH6

SHARP-CUTOFF PENTODE

Miniature type used as rf amplifier particularly in ac/dc receivers and in mobile equipment where low heater-current drain is important. It is particularly useful in high-frequency, wide-band applications. Outlines section, 5C; requires miniature 7-contact socket.

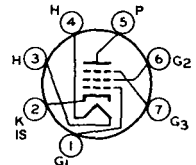

7CM

Heater Voltage (ac/dc)	6.3	volts
Heater Current	0.15	ampere
Peak Heater-Cathode Voltage	±90 max	volts
Direct Interelectrode Capacitances:*		
Grid No.1 to Plate	0.0035 max	pF
Grid No.1 to Cathode, Heater, Grid No.2, Grid No.3, and Internal Shield	5.4	pF
Plate to Cathode, Heater, Grid No.2, Grid No.3, and Internal Shield	4.4	pF

* Without external shield, or with external shield connected to cathode.

Class A₁ Amplifier

MAXIMUM RATINGS (Design-Center Values)

Plate Voltage	300	volts
Grid-No.2 (Screen-Grid) Voltage	See curve page 300	
Grid-No.2 Supply Voltage	300	volts
Grid-No.1 (Control-Grid) Voltage:		
Negative-bias value	50	volts
Positive-bias value	0	volts
Plate Dissipation	3	watts
Grid-No.2 Input:		
For grid-No.2 voltages up to 150 volts	0.5	watt
For grid-No.2 voltages between 150 and 300 volts	See curve page 300	

CHARACTERISTICS

Plate Voltage	100	250	volts
Grid No.3	Connected to cathode at socket		
Grid-No.2 Voltage	100	150	volts
Grid-No.1 Voltage	-1	-1	volt
Plate Resistance (Approx.)	0.7	1.4	megohms
Transconductance	3400	4600	μmhos
Plate Current	3.6	7.4	mA
Grid-No.2 Current	1.4	2.9	mA
Grid-No.1 Voltage (Approx.) for plate current of 10 μA	-5	-7.7	volts

Refer to chart at end of section.

6BH8

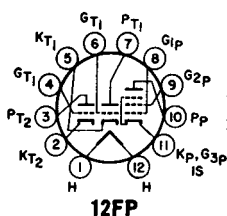

MEDIUM-MU TWIN TRIODE— SHARP-CUTOFF PENTODE **6BH11**

Duodecar type used in color and black-and-white television receiver applications. The triode units are used for general-purpose applications, and the pentode unit is used for horizontal-deflection service. **Outlines section, 8B;** requires duodecar 12-contact socket. **Heater:** volts (ac/dc), 6.3; amperes, 0.8; maximum heater-cathode volts, ± 200 peak, 100 average.

Pentode Unit as Horizontal-Deflection Oscillator

MAXIMUM RATINGS (Design-Maximum Values)

Plate Voltage	350	volts
Grid-No.2 (Screen-Grid) Voltage	330	volts
Grid-No.1 (Control-Grid) Voltage:		
Positive-bias value	0	volts
Peak negative value	175	volts
Peak Cathode Current	300	mA
Average Cathode Current	20	mA
Plate Dissipation	2.5	watts
Grid-No.2 Input	0.55	watt

Class A₁ Amplifier

MAXIMUM RATINGS (Design-Maximum Values)

Plate Voltage	330	volts
Grid Voltage, Positive-bias Value	0	volts
Plate Dissipation	2.5	watts

CHARACTERISTICS

	Pentode Unit	Each Triode Unit	
Plate Voltage	125	125	volts
Grid-No.2 Voltage	125	—	volts
Grid-No.1 Voltage	—	—	volt
Amplification Factor	—	46	
Plate Resistance (Approx.)	200000	5400	ohms
Transconductance	7500	8500	μ mhos
Plate Current	12	13.5	mA
Grid-No.2 Current	4	—	mA
Grid-No.1 Voltage (Approx.) for plate current of 10 μ A	—8	—8	volts

MAXIMUM CIRCUIT VALUES

Grid-No.1-Circuit Resistance:			
For fixed-bias operation	2.2	2.2	megohms
For cathode-bias operation	2.2	2.2	megohms

Refer to chart at end of section.

6BJ3

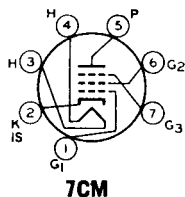

7CM

REMOTE-CUTOFF PENTODE **6BJ6**

Miniature type used as rf amplifier in high-frequency and wide-band applications. Features high transconductance and low grid-to-plate capacitance. **Outlines section, 5C;** requires miniature 7-contact socket.

Heater Voltage (ac/dc)	6.3	volts
Heater Current	0.15	ampere
Peak Heater-Cathode Voltage	± 90 max	volts
Direct Interelectrode Capacitances: ^a		
Grid No.1 to Plate	0.0035 max	pF
Grid No.1 to Cathode, Heater, Grid No.2, Grid No.3, and Internal Shield	4.5	pF
Plate to Cathode, Heater, Grid No.2, Grid No.3, and Internal Shield	5.5	pF

^a Without external shield, or with external shield connected to cathode.

Class A₁ Amplifier

MAXIMUM RATINGS (Design-Center Values)

Plate Voltage	300	volts
Grid-No.2 (Screen-Grid) Voltage	See curve page 300	
Grid-No.2 Supply Voltage	300	volts
Plate Dissipation	3	watts
Grid-No.2 Input:		
For grid-No.2 voltages up to 150 volts	0.6	watt
For grid-No.2 voltages between 150 and 300 volts	See curve page 300	
Grid-No.1 (Control-Grid) Voltage:		
Negative-bias value	50	volts
Positive-bias value	0	volts

CHARACTERISTICS

Plate Voltage	100	250	volts
Grid No.3	Connected to cathode	at socket	
Grid-No.2 Voltage	100	100	volts
Grid-No.1 Voltage	-1	-1	volt
Plate Resistance (Approx.)	0.25	1.3	megohms
Transconductance	3650	3600	μmhos
Plate Current	9	9.2	mA
Grid-No.2 Current	3.5	3.3	mA
Grid-No.1 Voltage (Approx.) for transconductance of 10 μmhos	-20	-20	volts

6BJ6A

Refer to chart at end of section.

For replacement use type 6BJ6.

6BJ7

Refer to chart at end of section.

6BJ8

TWIN DIODE—
MEDIUM-MU TRIODE

Miniature type used in black-and-white and color television receiver applications. The diode units are used in phase-detector, phase-comparator, ratio-detector or discriminator, and horizontal afc discriminator circuits. The triode unit is used in phase-splitter, audio-frequency amplifier, vertical-deflection amplifier, and low-frequency oscillator applications. Outlines section, 6E; 9-contact socket.

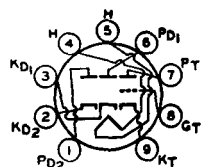

9ER

requires miniature

Heater Voltage (ac/dc)	6.3	volts
Heater Current	0.6	ampere
Heater Warm-up Time (Average)	11	seconds
Heater-Cathode Voltage:		
Peak value	±200 max	volts
Average value	100 max	volts
Direct Interelectrode Capacitances:		
Triode Unit:		
Grid to Plate	2.6	pF
Grid to Cathode and Heater	2.8	pF
Plate to Cathode and Heater	0.31	pF
Diode Units:		
Plate to Cathode and Heater (Each Unit)	1.9	pF
Cathode to Plate and Heater (Each Unit)	4.6	pF
Plate of Unit No.1 to Plate of Unit No.2	0.06 max	pF
Plate of Diode Unit No.1 to Triode Grid	0.07 max	pF
Plate of Diode Unit No.2 to Triode Grid	0.11 max	pF
Plate of Either Diode Unit to All Other Electrodes	3	pF
Cathode of Either Diode Unit to All Other Electrodes	4.8	pF

Triode Unit as Class A₁ Amplifier

MAXIMUM RATINGS (Design-Maximum Values)

Plate Voltage	330	volts
Grid Voltage, Positive-bias value	0	volts
Average Cathode Current	22	mA
Plate Dissipation	4	watts

CHARACTERISTICS

Plate Voltage	90	250	volts
Grid Voltage	0	-9	volts
Amplification Factor	22	20	
Plate Resistance (Approx.)	4700	7150	ohms
Transconductance	4700	2800	μmhos

Plate Current	13.5	8	mA
Plate Current for grid voltage of -12.5 volts	—	1.7	mA
Grid Voltage (Approx.) for plate current of 10 μ A ..	-7	-18	volts
MAXIMUM CIRCUIT VALUE			
Grid-Circuit Resistance		1	megohm

Triode Unit as Vertical-Deflection Amplifier

For operation in a 525-line, 30-frame system

MAXIMUM RATINGS (Design-Maximum Values)

DC Plate Voltage	330	volts
Peak Positive-Pulse Plate Voltage#	1200	volts
Peak Negative-Pulse Grid Voltage	275	volts
Peak Cathode Current	77	mA
Average Cathode Current	22	mA
Plate Dissipation	4	watts

MAXIMUM CIRCUIT VALUE

Grid-Circuit Resistance, for cathode-bias operation	2.2	megohms
# Pulse duration must not exceed 15% of a vertical scanning cycle (2.5 milliseconds).		

Diode Units

MAXIMUM RATINGS (Design-Maximum Values)

Plate Current (Each Unit):		
Peak	54	mA
Average	9	mA

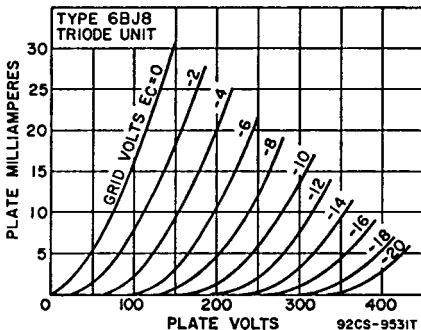

Refer to chart at end of section.

**6BK4
6BK4A
6BK4B**

**6BK4C/
6EL4A**

BEAM TRIODE

Glass octal type used for the voltage regulation of high-voltage, low-current dc power supplies in color and black-and-white television receivers. Outlines section, 21B; requires octal socket. Socket terminals 3, 4, 6, and 8 should not be used for tie points. For high voltage and X-ray safety considerations, refer to page 93.

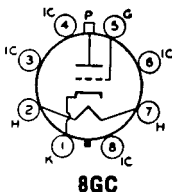

Heater Voltage (ac/dc)	6.3	volts
Heater Current	0.2	ampere
Peak Heater-Cathode Voltage	-450* max	volts
Direct Interelectrode Capacitances (Approx.):		
Grid to Plate	0.03	pF
Grid to Cathode and Heater	2.6	pF
Plate to Cathode and Heater	1	pF

Shunt Voltage-Regulator Service

MAXIMUM RATINGS (Design-Maximum Values)

DC Plate Voltage	27000	volts
Unregulated DC Supply Voltage	60000	volts
DC Grid Voltage	-135	volts
Peak Grid Voltage*	-440	mA
Average Plate Current	1.6	mA
Plate Dissipation	40	watts

TYPICAL OPERATION

Unregulated DC Supply Voltage	36000	volts
Equivalent Resistance of Unregulated Supply	11	megohms
Voltage Divider Values:		
R ₁ (5 watts)	220	megohms
R ₂ (2 watts)	1	megohm
R ₃ (0.5 watt)	0.82	megohm
DC Reference Voltage Supply	200	volts
Equivalent Resistance of Reference Voltage	1000	ohms
Effective Grid-Plate Transconductance	200	μmhos
DC Plate Current for Load Current of 0 mA	1000	μA
DC Plate Current for Load Current of 1 mA	45	μA
Regulated DC Output Voltage for Load Current of 0 mA	25000	volts
Regulated DC Output Voltage for Load Current of 1 mA	24500	volts

MAXIMUM CIRCUIT VALUE

Grid-Circuit Resistance	3	megohms
-------------------------	---	---------

* For interval of 20 seconds maximum duration during equipment warm-up period.

X-RADIATION CHARACTERISTIC

X-Radiation, Maximum:		
Statistical value controlled on a lot sampling basis	0.5	mR/hr

CHARACTERISTICS RANGE VALUES

	Note	Min	Max	
Grid Voltage (1)	1	-7	—	volts
Grid Voltage (2)	2	—	-40	volts
Grid-Voltage Change	3	—	9	volts

Note 1: With dc plate voltage of 30000 volts and dc plate current of 1 mA.

Note 2: With dc plate voltage of 30000 volts and dc plate current of 0.1 mA.

Note 3: Difference between grid voltage (1) and grid voltage (2).

Caution—Operation of this tube outside of the maximum values indicated above may result in either temporary or permanent changes in the X-radiation characteristic of the tube. Equipment design must be such that these maximum values are not exceeded.

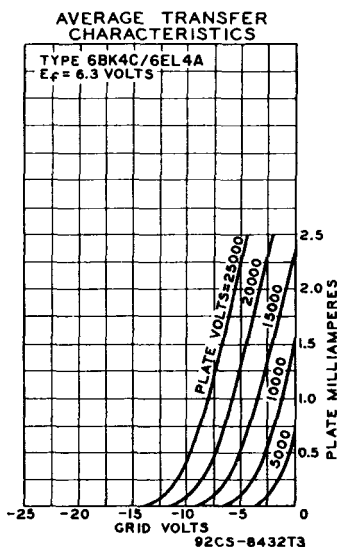

* Series impedance should be used with the cathode to limit the cathode current under prolonged short-circuit conditions to 450 mA.

† Without external shield.

Refer to chart at end of section.

6BK5

Refer to chart at end of section.

6BK7A

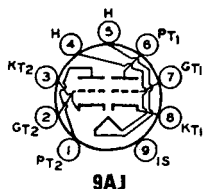

MEDIUM-MU TWIN TRIODE

6BK7B

5BK7A

Miniature type used as a cascode amplifier in vhf color and black-and-white television tuners and in push-pull cathode-drive rf amplifiers. Outlines section, 6B; requires miniature 9-contact socket. For typical operation as a resistance-coupled amplifier, refer to Resistance-Coupled Amplifier section. Type 5BK7A is identical with type 6BK7B except for heater ratings.

	5BK7A	6BK7B	
Heater Voltage (ac/dc)	4.7	6.3	volts
Heater Current	0.6	0.45	ampere
Heater Warm-up Time (Average)	11	11	seconds
Heater-Cathode Voltage:			
Peak value	±200*max	±200*max	volts
Average value	100 max	100 max	volts
Direct Interelectrode Capacitances:			
	Unit No.1	Unit No.2	
Grid to Plate	1.8	1.8	pF
Grid to Cathode, Heater, and Internal Shield	3	3	pF
Plate to Cathode, Heater, and Internal Shield	1	0.9	pF
Cathode to Grid, Heater, and Internal Shield	6	6	pF
Plate to Grid, Heater, and Internal Shield	2.4	2.4	pF
Plate to Cathode	0.22	0.22	pF
Heater to Cathode	2.8	3	pF
Grid of Unit No.1 to Grid of Unit No.2		0.004 max	pF
Plate of Unit No.1 to Plate of Unit No.2		0.075 max	pF

* Rating may be as high as 300 volts under cutoff conditions when tube is used as a cascode amplifier, the units are connected in series, and heater is negative with respect to cathode.

Class A₁ Amplifier (Each Unit)

MAXIMUM RATINGS (Design-Center Value)

Plate Voltage	300	volts
Grid Voltage, Negative-bias value	50	volts
Plate Dissipation	2.7	watts

CHARACTERISTICS

Plate Supply Voltage	150	volts
Cathode-Bias Resistor	56	ohms
Amplification Factor	43	
Plate Resistance (Approx.)	4600	ohms
Transconductance	9300	μmhos
Plate Current	18	mA
Grid Voltage (Approx.) for plate current of 10 μA	-11	volts

Refer to chart at end of section.

6BL4

Refer to chart at end of section.

6BL7GT

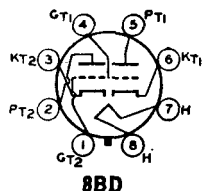

8BD

MEDIUM-MU TWIN TRIODE

6BL7GTA

Glass octal type used as combined vertical-deflection amplifier and vertical-deflection oscillator in color and black-and-white television receivers. When so operated, it is recommended that unit No.1 (pins 4, 5, and 6) be used as the oscillator. Outlines section, 13D; requires octal socket.

Heater Voltage (ac/dc)	6.3	volts
Heater Current	1.5	amperes
Heater-Cathode Voltage:		
Peak value	±200 max	volts
Average value	100 max	volts

Direct Interelectrode Capacitances (Approx.):	Unit No. 1	Unit No. 2	
Grid to Plate	6	6	pF
Grid to Cathode and Heater	4.2	4.6	pF
Plate to Cathode and Heater	0.9	0.9	pF

Class A₁ Amplifier

CHARACTERISTICS (Each Unit)

Plate Voltage	150	250	250	volts
Grid Voltage	0	-17	-9	volts
Amplification Factor	—	—	15	
Plate Resistance (Approx.)	—	—	2150	ohms
Transconductance	—	—	7000	μmhos
Plate Current	65*	4	40	mA
Grid Voltage (Approx.) for plate current of 50 μA	—	—	-23	volts

* This value can be measured by a method involving a recurrent waveform such that the maximum ratings of the tube will not be exceeded.

Vertical-Deflection Oscillator or Amplifier*

For operation in a 525-line, 30-frame system

MAXIMUM RATINGS (Design-Center Values)	Oscillator	Amplifier	
DC Plate Voltage	500	500	volts
Peak Positive-Pulse Plate Voltage# (Absolute Maximum)	—	2000 ^Δ	volts
Peak Negative-Pulse Grid Voltage	400	250	volts
Peak Cathode Current	210	210	mA
Average Cathode Current	60	60	mA
Plate Dissipation:			
For either plate	10	10	watts
For both plates with both units operating	12	12	watts

MAXIMUM CIRCUIT VALUE

Grid-Circuit Resistance	4.7	4.7†	megohms
-------------------------------	-----	------	---------

* Unless otherwise specified, values are for each unit.

Pulse duration must not exceed 15% of a vertical scanning cycle (2.5 milliseconds).

Δ Under no circumstances should this absolute value be exceeded.

† For cathode-bias operation.

6BL8

Refer to chart at end of section.

6BL8/ ECF80

4BL8/XCF80

MEDIUM-MU TRIODE— SHARP-CUTOFF PENTODE

Miniature type used in frequency-changer service in color and black-and-white television receivers. Outlines section, 6B; require miniature 9-contact socket. Type 4BL8/XCF80 is identical with type 6BL8/ECF80 except for heater ratings.

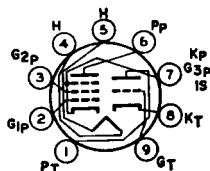

9DC

Heater Voltage (ac/dc)	4BL8/ XCF80	6BL8/ ECF80	
Heater Current	4.6	6.3	volts
Peak Heater-Cathode Voltage	0.6	0.45	ampere
	±100 max	±100 max	volts

Class A₁ Amplifier

MAXIMUM RATINGS (Design-Center Values)	Triode Unit	Pentode Unit	
Plate Supply Voltage	550	550	volts
Plate Voltage	250	250	volts
Grid-No.2 (Screen-Grid) Supply Voltage	—	550	volts
Grid-No.2 Voltage:			
With cathode current of 14 mA	—	175	volts
With cathode current less than 10 mA	—	200	volts
Cathode Current	14	14	mA
Plate Dissipation	1.5	1.7	watts
Grid-No.2 Input:			
With plate dissipation greater than 1.2 watts ..	—	0.5	watt
With plate dissipation less than 1.2 watts ..	—	0.75	watt

CHARACTERISTICS

Plate Voltage	100	170	volts
Grid-No.2 Voltage	—	170	volts
Grid-No.1 Voltage	-2	-2	volts
Amplification Factor	20	—	
Mu-Factor, Grid No.2 to Grid No.1	—	47	
Plate Resistance (Approx.)	—	0.4	megohm
Transconductance	5000	6200	μmbos
Plate Current	14	10	mA
Grid-No.2 Current	—	2.8	mA
Input Resistance at frequency of 50 MHz	—	0.01	megohm
Equivalent Noise Resistance	—	1500	ohms

MAXIMUM CIRCUIT VALUES

Grid-No.1-Circuit Resistance:			
For fixed-bias operation	0.5	0.5	megohm
For cathode-bias operation	0.5	1	megohm

**6BM8/
ECL82**

50BM8/UCL82

**HIGH-MU TRIODE—
POWER PENTODE**

Miniature type used in color and black-and-white television receiver applications. The pentode unit is used as an audio output tube, and the triode unit as an oscillator and af voltage amplifier. Outlines section, 6G; requires miniature 9-contact socket. Type 50BM8/UCL82 is identical with type 6BM8/ECL82 except for heater ratings.

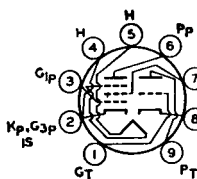

9EX

Heater Voltage	6.3	50	volts
Heater Current	0.78	0.1	ampere
Peak Heater Cathode Voltage	100 max	±200 max	volts

Class A₁ Amplifier

MAXIMUM RATINGS (Design-Center Values)

	Triode Unit	Pentode Unit	
Plate Supply Voltage	550	900	volts
Plate Voltage	300	600	volts
Grid-No.2 Supply Voltage	—	550	volts
Grid-No.2 Voltage	—	300	volts
Cathode Current	15	50	mA
Plate Dissipation	1	7	watts
Grid-No.2 Input	—	1.8	watts

CHARACTERISTICS

Plate Voltage	100	200	volts
Grid-No.2 Voltage	—	200	volts
Grid-No.1 Voltage	0	-16	volts
Amplification Factor	70	9.5*	
Plate Resistance (Approx.)	—	0.02	megohm
Transconductance	2500	6400	μmbos
Plate Current	3.5	35	mA
Grid-No.2 Current	—	7	mA

MAXIMUM CIRCUIT VALUES

Grid-No.1-Circuit Resistance:			
For fixed-bias operation	1	1	megohm
For cathode-bias operation	2	2	megohms

* Grid No.2 to Grid No.1

Refer to chart at end of section.

6BN4

6BN4A

2BN4A, 3BN4A

MEDIUM-MU TRIODE

Miniature type used as rf amplifier tube in grid-drive circuits of vhf color and black-and-white television tuners. Outlines section, 5C; requires miniature 7-contact socket. Types 2BN4A and 3BN4A are identical with type 6BN4A except for heater ratings.

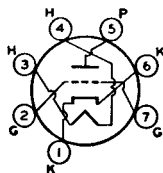

7EG

	2BN4A	3BN4A	6BN4A	
Heater Voltage (ac/dc)	2.35	3	6.3	volts
Heater Current	0.6	0.45	0.2	ampere
Heater Warm-up Time (Average)	11	11	—	seconds
Peak Heater-Cathode Voltage	±100 max	±100 max	±100 max	volts
Direct Interelectrode Capacitances (Approx.):*				
Grid to Plate			1.2	pF
Grid to Cathode and Heater			3.2	pF
Plate to Cathode and Heater			1.4	pF

* With external shield connected to cathode.

Class A₁ Amplifier

MAXIMUM RATINGS (Design-Center Values)

Plate Voltage	275	volts
Grid Voltage, Positive-bias value	0	volts
Cathode Current	22	mA
Plate Dissipation	2.2	watts

CHARACTERISTICS

Plate-Supply Voltage	150	volts
Cathode-Bias Resistor	220	ohms
Amplification Factor	43	
Plate Resistance (Approx.)	5400	ohms
Transconductance	7700	μmhos
Plate Current	9	mA
Grid Voltage (Approx.) for plate current of 100 μA	-6	volts

MAXIMUM CIRCUIT VALUE

Grid-Circuit Resistance	0.5	megohm
-------------------------------	-----	--------

6BN6

Refer to chart at end of section.

6BN6/6KS6

3BN6, 4BN6

BEAM TUBE

Miniature type used as combined limiter, discriminator, and audio-voltage amplifier in intercarrier television and FM receivers. Outlines section, 5D; requires miniature 7-contact socket. Types 3BN6 and 4BN6 are identical with type 6BN6/6KS6 except for heater ratings.

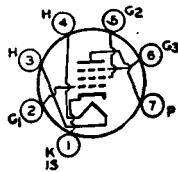

7DF

	3BN6	4BN6	6BN6/6KS6	12BN6	
Heater Voltage (ac/dc)	3.15	4.2	6.3	12.6	volts
Heater Current	0.6	0.45	0.3	0.15	ampere
Heater Warm-up Time (Average)	11	11	—	—	seconds
Heater-Cathode Voltage:					
Peak value	±200 max	±200 max	±200 max	±200 max	volts
Average value	100 max	100 max	100 max	100 max	volts
Direct Interelectrode Capacitances:					
Grid No.1 to Cathode, Heater, Grid No.2, Grid No.3, and Internal Shield				4.2	pF
Grid No.3 to Cathode, Heater, Grid No.1, Grid No.2, and Internal Shield				3.3	pF
Grid No.1 to Grid No.3				0.004 max	pF

Limiter and Discriminator Service

MAXIMUM RATINGS (Design-Maximum Values)

Plate-Supply Voltage	330	volts
Grid-No.2 Voltage	110	volts
Grid-No.1 Voltage, Positive peak value	60	volts
Cathode Current	13	mA

**TWIN DIODE—
HIGH-MU TWIN TRIODE**

**6BN8
8BN8**

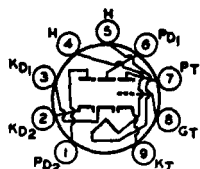

9ER

Miniature type used in color and black-and-white television receiver applications. The triode unit is used in burst-amplifier, af amplifier, and low-frequency oscillator applications. The diode units are used in phase-detector, ratio-detector or discriminator, and horizontal afc discriminator circuits. Outlines section, 6E; requires miniature 9-contact socket. Type 8BN8 is identical with type 6BN8 except for heater ratings.

	6BN8	8BN8	
Heater Voltage (ac/dc)	6.3	8.4	volts
Heater Current	0.6	0.45	ampere
Heater Warm-up Time (Average)	11	11	seconds
Heater-Cathode Voltage:			
Peak value	±200 max	±200 max	volts
Average value	100 max	100 max	volts
Direct Interelectrode Capacitances:			
Triode Grid to Triode Plate		2.5	pF
Triode Grid to Cathode and Heater		3.6	pF
Triode Plate to Cathode and Heater		0.25	pF
Plate of Diode Unit No.1 to Triode Grid		0.06 max	pF
Plate of Diode Unit No.2 to Triode Grid		0.1 max	pF
Plate of Diode Unit No.1 to Plate of Diode Unit No.2		0.07 max	pF
Diode Cathode to All Other Electrodes (Each Diode Unit)		5	pF
Diode Plate to Diode Cathode and Heater (Each Diode Unit)		1.9	pF
Diode Cathode to Diode Plate and Heater (Each Diode Unit)		4.8	pF
Diode Plate to All Other Electrodes (Each Diode Unit)		3	pF

Triode Unit as Class A₁ Amplifier

MAXIMUM RATINGS (Design-Maximum Values)

Plate Voltage	330	volts
Grid Voltage, Positive-bias value	0	volts
Plate Dissipation	1.7	watts

CHARACTERISTICS

Plate Voltage	100	250	volts
Grid Voltage	-1	-3	volts
Amplification Factor	75	70	
Plate Resistance (Approx.)	21000	28000	ohms
Transconductance	3500	2500	μmhos
Plate Current	1.5	1.6	mA
Grid Voltage (Approx.) for plate current of 10 μA	-2.5	-5.5	volts

MAXIMUM CIRCUIT VALUE

Grid-Circuit Resistance	1	megohm
-------------------------	---	--------

Diode Units

MAXIMUM RATINGS (Design-Maximum Values)

Plate Current (Each Unit):		
Peak	54	mA
Average	9	mA

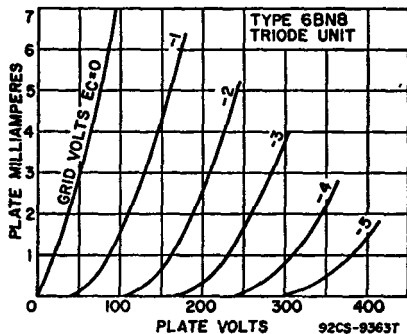

6BN11**SHARP-CUTOFF
TWIN PENTODE**

Duodecar type used as if-amplifier tube in television receivers. Outlines section, 8B; requires duodecar 12-contact socket.

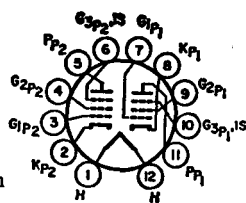
**12GF**

Heater Voltage	6.3	volts
Heater Current	0.8	ampere
Heater Warm-up Time	—	seconds
Heater-Cathode Voltage:		
Peak value	±200 max	volts
Average value	100 max	volts

Class A₁ Amplifier (Each Unit)**MAXIMUM RATINGS (Design-Maximum Values)**

Plate Voltage	330	volts
Grid-No.2 (Screen-Grid) Supply Voltage	330	volts
Grid-No.2 Voltage	See curve page 300	
Grid-No.1 (Control-Grid) Voltage, Positive-bias value	0	volts
Plate Dissipation	3.1	watts
Grid-No.2 Input	0.65	watt

CHARACTERISTICS

Plate Voltage	125	volts
Grid No.3 (Suppressor Grid)	Connected to cathode at socket	
Grid-No.2 Voltage	125	volts
Cathode-Bias Resistor	56	ohms
Plate Resistance (Approx.)	0.2	megohm
Transconductance	13000	μmhos
Plate Current	11	mA
Grid-No.2 Current	3.8	mA
Grid-No.1 Voltage (Approx.) for plate current of 20 μA	-3	volts

MAXIMUM CIRCUIT VALUE

Grid-No.1-Circuit Resistance, for cathode-bias operation	0.25	megohm
----------------------------------------------------------	------	--------

6BQ5

For replacement use type 6BQ5/EL84.

6BQ5/EL84

8BQ5, 10BQ5

POWER PENTODE

Miniature type used in the output stage of audio-frequency amplifiers. Outlines section, 6G; requires miniature 9-contact socket. Types 8BQ5 and 10BQ5 are identical with type 6BQ5/EL84 except for heater ratings.

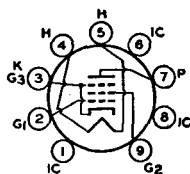
**9CV**

	6BQ5/EL84	8BQ5	10BQ5	
Heater Voltage (ac/dc)	6.3	8	10.6	volts
Heater Current	0.76	0.6	0.45	ampere
Heater Warm-up Time (Average)	—	11	11	seconds
Heater-Cathode Voltage:				
Peak value	±100 max	±100 max	±100 max	volts
Average value	100 max	100 max	100 max	volts
Direct Interelectrode Capacitances:				
Grid No.1 to Plate			0.5 max	pF
Grid No.1 to Cathode, Heater, Grid No.2, and Grid No.3			10.8	pF
Plate to Cathode, Heater, Grid No.2, and Grid No.3			6.5	pF
Grid No.1 to Heater			0.25 max	pF

Class A₁ Amplifier**MAXIMUM RATINGS (Design-Center Values)**

Plate Voltage	300	volts
Grid-No.2 (Screen-Grid) Voltage	300	volts
Grid-No.1 (Control-Grid) Voltage, Positive-bias value	0	volts
Cathode Current	65	mA

Plate Dissipation	12	watts
Grid No.2 Input	2	watts

TYPICAL OPERATION

Plate Voltage	250	volts
Grid-No.2 Voltage	250	volts
Grid-No.1 (Control-Grid) Voltage	-7.3	volts
Peak AF Grid No.1 Voltage	6.2	volts
Zero-Signal Plate Current	48	mA
Maximum-Signal Plate Current	50.6	mA
Zero-Signal Grid-No.2 Current	5.5	mA
Maximum-Signal Grid-No.2 Current	10	mA
Plate Resistance (Approx.)	38000	ohms
Transconductance	11300	μmhos
Load Resistance	4500	ohms
Total Harmonic Distortion	10	per cent
Maximum-Signal Power Output	5.7	watts

MAXIMUM CIRCUIT VALUES

Grid-No.-Circuit Resistance:		
For fixed-bias operation	0.3	megohm
For cathode-bias operation	1	megohm

Push-Pull Class AB₁ Amplifier

MAXIMUM RATINGS (Same as for Single-Tube Class A₁ Amplifier)

TYPICAL OPERATION (Values are for two tubes)

Plate Supply Voltage	250	300	volts
Grid-No.2 Supply Voltage	250	300	volts
Cathode-Bias Resistor	130	130	ohms
Peak AF Grid-No.1-to-Grid-No.1 Voltage	22.6	28.3	volts
Zero-Signal Plate Current	62	72	mA
Maximum-Signal Plate Current	75	92	mA
Zero-Signal Grid-No.2 Current	7	8	mA
Maximum-Signal Grid-No.2 Current	15	22	mA
Effective Load Resistance (Plate-to-plate)	8000	8000	ohms
Total Harmonic Distortion	3	4	per cent
Maximum-Signal Power Output	11	17	watts

MAXIMUM CIRCUIT VALUES

Grid-No.1-Circuit Resistance:		
For fixed-bias operation	0.3	megohm
For cathode-bias operation	1	megohm

Refer to chart at end of section.

6BQ6GT

**6BQ6GTB
/6CU6**

12BQ6GTB/12CU6,
25BQ6GTB/25CU6

BEAM POWER TUBE

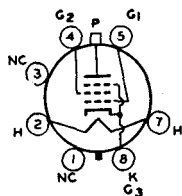

6AM

Glass octal type used as horizontal-deflection amplifier in color and black-and-white television receivers. Outlines section, 14D; requires octal socket. This type may be supplied with pin No.1 omitted. Types 12BQ6GTB/12CU6 and 25BQ6GTB/25CU6 are identical with type 6BQ6GTB/6CU6 except for heater ratings.

	6BQ6GTB/ 6CU6	12BQ6GTB/ 12CU6	25BQ6GTB/ 25CU6	
Heater Voltage (ac/dc)	6.3	12.6	25	volts
Heater Current	1.2	0.6	0.3	ampere
Heater Warm-up Time (Average)	—	11	—	seconds
Heater-Cathode Voltage:				
Peak value	±200 max	±200 max	±200 max	volts
Average value	100 max	100 max	100 max	volts
Direct Interelectrode Capacitances (Approx.):				
Grid No.1 to Plate			0.6	pF
Grid No.1 to Cathode, Heater, Grid No.2, and Grid No.3			15	pF
Plate to Cathode, Heater, Grid No.2, and Grid No.3			7	pF

Class A₁ Amplifier

CHARACTERISTICS

Plate Voltage	60	150	250	volts
Grid-No.2 Voltage	150	150	150	volts
Grid-No.1 Voltage	0	-22.5	-22.5	volts
Mu-Factor, Grid No.2 to Grid No.1	—	4.3	—	
Plate Resistance (Approx.)	—	—	14500	ohms
Transconductance	—	—	5900	μmhos
Plate Current	260*	—	57	mA
Grid-No.2 Current	26*	—	2.1	mA
Grid-No.1 Voltage (Approx.) for plate mA = 1	—	—	-43	volts

* These values can be measured by a method involving a recurrent waveform such that the maximum ratings of the tube will not be exceeded.

Horizontal-Deflection Amplifier

For operation in a 525-line, 30-frame system

MAXIMUM RATINGS (Design-Center Values)

DC Plate Voltage	600	volts
Peak Positive-Pulse Plate Voltage [#] (Absolute Maximum)	6000†	volts
Peak Negative-Pulse Plate Voltage	1250	volts
DC Grid-No.2 (Screen-Grid) Voltage	200	volts
Peak Negative-Pulse Grid-No.1 (Control-Grid) Voltage	300	volts
Peak Cathode Current	400	mA
Average Cathode Current	110	mA
Plate Dissipation*	11	watts
Grid-No.2 Input	2.5	watts
Bulb Temperature (At hottest point)	220	°C

MAXIMUM CIRCUIT VALUE

Grid-No.1-Circuit Resistance	0.47	megohm
* Pulse duration must not exceed 15% of a horizontal scanning cycle (10 microseconds).		
† Under no circumstances should this absolute value be exceeded.		

* A bias resistor or other means is required to protect the tube in absence of excitation.

6BQ7

Refer to chart at end of section.

For replacement use type 6BQ7A/6BZ7/6BS8.

6BQ7A

For replacement use type 6BQ7A/6BZ7/6BS8.

**6BQ7A/
6BZ7/
6BS8**

4BQ7A/4BZ7,
5BQ7A

MEDIUM-MU TWIN TRIODE

Miniature type used as a cascode amplifier in vhf color and black-and-white television tuners in push-pull cathode-drive rf amplifiers. Outlines section, 6B; requires miniature 9-contact socket. For typical operation as a resistance-coupled amplifier, refer to Resistance-Coupled Amplifier section. Types 4BQ7A/4BZ7 and 5BQ7A are identical with type 6BQ7A/6BZ7/6BS8 except for heater ratings.

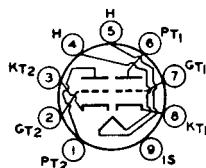

9AJ

	4BQ7A/ 4BZ7	5BQ7A	6BQ7A/6BZ7/ 6BS8	
Heater Voltage (ac/dc)	4.2	5.6	6.3	volts
Heater Current	0.6	0.45	0.4	ampere
Heater Warm-up Time (Average)	11	11	—	seconds
Heater-Cathode Voltage:				
Peak value	±200*max	±200*max	±200*max	volts
Average value	100 max	100 max	100 max	volts

Direct Interelectrode Capacitances:*

	Unit No.1	Unit No.2	
Grid to Plate	1.2	1.2	pF
Grid to Cathode, Heater, and Internal Shield	2.6	—	pF
Cathode to Grid, Heater, and Internal Shield	—	5	pF
Plate to Cathode, Heater, and Internal Shield	1.2	—	pF
Plate to Grid, Heater, and Internal Shield	—	2.2	pF
Plate to Cathode	0.12	0.12	pF
Heater to Cathode	2.6	2.6	pF
Plate of Unit No.1 to Plate of Unit No.2	—	0.010 max	pF
Plate of Unit No.2 to Plate and Grid of Unit No.1	—	0.024 max	pF

* Rating may be high as 300 volts under cutoff conditions, when tube is used as a cascode amplifier, the two units are connected in series, and heater is negative with respect to cathode.

* With external shield connected to internal shield.

Class A₁ Amplifier (Each Unit)

MAXIMUM RATINGS (Design-Center Values)

Plate Supply Voltage	250*	volts
Cathode Current	20	mA
Plate Dissipation	2	watts

CHARACTERISTICS

Plate Supply Voltage	150	volts
Cathode-Bias Resistor	220	ohms
Amplification Factor	38	
Plate Resistance (Approx.)	5900	ohms
Transconductance	6400	μmhos
Plate Current	9	mA
Grid Voltage (Approx.):		
For plate current of 100 μA	-6.5	volts
For plate current of 10 μA	—	volts

MAXIMUM CIRCUIT VALUE

Grid-Circuit Resistance	0.5	megohm
-------------------------	-----	--------

* Rating may be high as 300 volts under cutoff conditions, when tube is used as a cascode amplifier, the two units are connected in series, and heater is negative with respect to cathode.

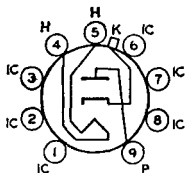
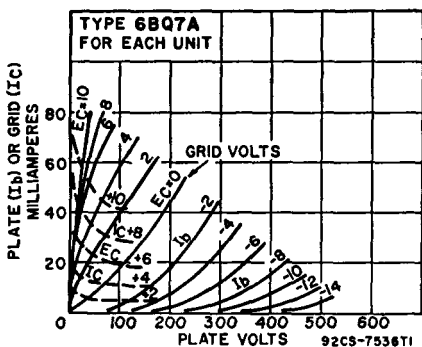

9CB

HALF-WAVE VACUUM RECTIFIER

6BR3/
6RK19

17BR3/17RK19

Miniature type used as damper tube in horizontal-deflection circuits of television receivers. Outlines section, 7D; requires miniature 9-contact socket. Type 17BR3/17RK19 is identical with type 6BR3/6RK19 except for heater ratings.

Heater Voltage (ac/dc)	6.3	16.8	volts
Heater Current	1.2	0.45	ampere
Heater Warm-up Time	—	11	seconds

Damper Service

For operation in a 525-line, 30-frame system

MAXIMUM RATINGS (Design-Maximum Values)

Peak Inverse Plate Voltage#	5500	volts
Peak Plate Current	1200	mA
Average Plate Current	200	mA
Plate Dissipation	6.5	watts
Heater-Cathode Voltage:		
Peak value	+300	-5500
Average value	+100	-900
Bulb Temperature (At hottest point)	180	°C

CHARACTERISTIC, Instantaneous Value

Tube Voltage Drop for plate current of 250 mA	19	volts
# Pulse duration must not exceed 15% of a horizontal scanning cycle (10 microseconds).		

6BR8

Refer to chart at end of section.

For replacement use type 6BR8A/6FV8A.

6BR8A

For replacement use type 6BR8A/6FV8A.

6BR8A/ 6FV8A

5BR8/5FV8

MEDIUM-MU TRIODE— SHARP-CUTOFF PENTODE

Miniature type used in color and black-and-white television receiver applications. Especially useful as combined triode oscillator and pentode mixer in vhf television tuners. Outlines section, 6B; requires miniature 9-contact socket. Except for basing arrangement and grid-No.1-to-plate capacitance of pentode unit, types 5BR8/5FV8 and 6BR8A/6FV8A are identical with types 5U8 and 6U8A, respectively.

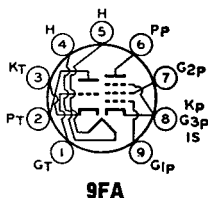

9FA

6BS3

Refer to chart at end of section.

For replacement use type 6BS3A.

6BS3A

12BS3A/
12DW4A, 17BS3A
17BS3A/17DW4A

HALF-WAVE VACUUM RECTIFIER

Novar type used as damper tube in horizontal-deflection circuits of black-and-white television receivers. Outlines section, 30B; requires novar 9-contact socket. Socket terminals 1, 3, 6, and 8 should not be used as tie points; it is recommended that socket clips for these pins be removed to reduce the possibility of arc-over and to minimize leakage. These tubes, like other power-handling tubes, should be adequately ventilated. Types 12BS3A/12DW4A, 17BS3A, and 17BS3A/17DW4A are identical with type 6BS3A except for heater ratings.

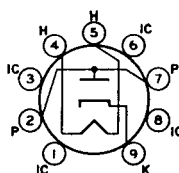

9HP

	6BS3A	12BS3A/ 12DW4A	17BS3A/ 17BS3A/ 17DW4A	
Heater Voltage (ac/dc)	6.3	12.6	16.8	volts
Heater Current	1.2	0.6	0.45	amperes
Heater Warm-up Time (Average)	—	11	11	seconds
Direct Interelectrode Capacitances (Approx.):				
Plate to Cathode and Heater			6.5	pF
Cathode to Plate and Heater			9	pF
Heater to Cathode			2.8	pF

Damper Service

For operation in a 525-line, 30-frame system

MAXIMUM RATINGS (Design-Maximum Values)

Peak Inverse Plate Voltage#	5000	volts	
Peak Plate Current	1100	mA	
Average Plate Current	200	mA	
Plate Dissipation	6	watts	
Heater-Cathode Voltage:			
Peak value	+300	-5000	volts
Average value	+100	-900	volts

CHARACTERISTIC, Instantaneous Value

Tube Voltage Drop for plate current of 140 mA	12	volts
-----------------------------------------------	----	-------

Pulse duration must not exceed 15% of a horizontal scanning cycle (10 microseconds).

Refer to chart at end of section.
For replacement use type 6BQ7A/6BZ7/6BS8.

6BS8

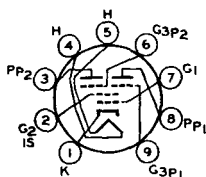

9FG

**SHARP-CUTOFF
TWIN PENTODE**

6BU8

3BU8/3GS8
4BU8/4GS8

Miniature type used as combined sync separator, sync clipper, and age amplifier tube in color and black-and-white television receivers. Outlines section, 6E; requires miniature 9-contact socket. Types 3BU8/3GS8 and 4BU8/4GS8 are identical with type 6BU8 except for heater ratings.

	3BU8/3GS8	4BU8/4GS8	6BU8	
Heater Voltage (ac/dc)	3.15	4.2	6.3	volts
Heater Current	0.6	0.45	0.3	ampere
Heater Warm-up Time (Average)	11	11	—	seconds
Heater-Cathode Voltage:				
Peak value	±200 max	±200 max	±200 max	volts
Average value	100 max	100 max	100 max	volts
Direct Interelectrode Capacitances:				
Grid No.3 to Plate (Each Unit)			1.9	pF
Grid No.1 to All Other Electrodes			6	pF
Grid No.3 to All Other Electrodes (Each Unit)			3.6	pF
Plate to All Other Electrodes (Each Unit)			3	pF
Grid No.3 of Unit No.1 to Grid No.3 of Unit No.2			0.015 max	pF

Class A₁ Amplifier

MAXIMUM RATINGS (Design-Maximum Values)

Plate Voltage (Each Unit)	300	volts
Grid-No.3 (Suppressor-Grid) Voltage (Each Unit):		
Peak positive value	50	volts
DC negative value	50	volts
DC positive value	3	volts
Grid-No.2 (Screen-Grid) Voltage	150	volts
Grid-No.1 (Control-Grid) Voltage, Negative bias value	50	volts
Cathode Current	12	mA
Plate Dissipation (Each Unit)	1.1	watts
Grid-No.2 Input	0.75	watt

CHARACTERISTICS (With Both Units Operating)

Plate Voltage (Each Unit)	100	100	volts
Grid-No.3 Voltage (Each Unit)	-10	0	volts
Grid-No.2 Voltage	67.5	67.5	volts
Grid-No.1 Voltage	*	*	volts
Plate Current (Each Unit)	—	2.2	mA
Grid-No.2 Current	6.5	3.3	mA
Cathode Current	6.6	7.8	mA

CHARACTERISTICS (With One Unit Operating)

Plate Voltage	100	100	volts
Grid-No.3 Voltage	0	0	volts
Grid-No.2 Voltage	67.5	67.5	volts
Grid-No.1 Voltage	0	*	volts
Grid-No.3 Transconductance	—	180	μmhos
Grid-No.1 Transconductance	1500	—	μmhos

Plate Current	—	2.2	mA
Grid-No.3 Voltage (Approx.) for plate current of 100 μ A	—	-4.5	volts
Grid-No.1 Voltage (Approx.) for plate current of 100 μ A	—	-2.3	volts

MAXIMUM CIRCUIT VALUES

Grid-No.3-Circuit Resistance (Each Unit)	0.5	megohm
Grid-No.1-Circuit Resistance	0.5	megohm

* Adjusted to provide a dc grid-No.1 current of 100 microamperes.

† With plate and grid No.3 of the other unit connected to ground.

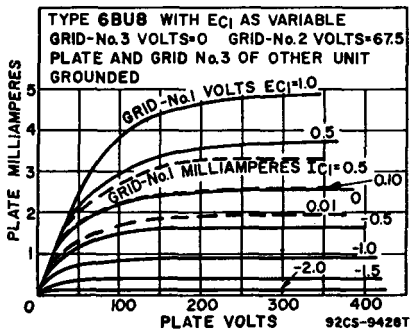
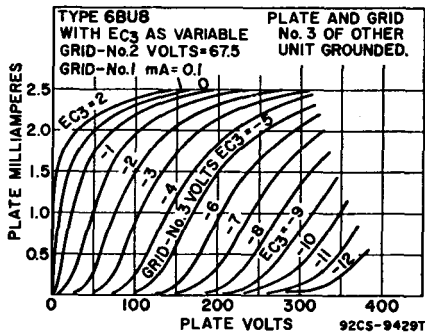
**6BV8**

Refer to chart at end of section.

6BV11

12BV11

**SHARP-CUTOFF
TWIN PENTODE**

Duodecar type used as color demodulators in color television applications. Grid Nos. 1 and 3 may be used as independent control electrodes. Outlines section, 8C; requires duodecar 12-contact socket. Type 12BV11 is identical with type 6BV11 except for heater ratings.

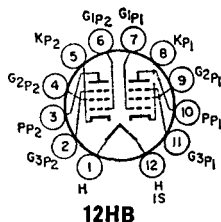
**12HB**

Heater Arrangement	6BV11 Series	12BV11 Parallel	
Heater Voltage (ac/dc)	6.3	12.6	
Heater Current	0.9	0.45	volts
Heater Warm-up Time	—	11	ampere seconds
Direct Interelectrode Capacitances:			
Grid No.1 to Plate		0.1	pF
Grid No.3 to Plate		3.2	pF
Grid No.1 to Heater, Cathode, Grid No.2, Grid No.3, and Internal Shield		7	pF
Grid No.3 to All Other Electrodes		8.5	pF
Grid No.1 to Grid No.3		0.08	pF

Class A₁ Amplifier (Each Unit)**MAXIMUM RATINGS (Design-Maximum Values)**

DC Plate Voltage	300	volts
Grid-No.3 (Suppressor-Grid) Voltage:		
Positive-bias value	25	volts
Negative-bias value	100	volts
Grid-No.2 (Screen-Grid) Supply Voltage	300	volts
Grid-No.2 Voltage	See curve page 300	
Grid-No.1 (Control-Grid) Voltage:		
Positive-bias value	0	volt
Negative-bias value	50	volts
Plate Dissipation	1.7	watts
Grid-No.3 Input	0.1	watt
Grid-No.2 Input:		
For grid-No.2 voltages up to 150 volts	1	watt
For grid-No.2 voltages between 150 and 300 volts	See curve page 300	

CHARACTERISTICS

Plate Supply Voltage	150	volts
Grid-No.3 Voltage	0	volt
Grid-No.2 Supply Voltage	100	volts
Cathode Resistor	180	ohms
Plate Current	3.1	mA
Grid-No.2 Current	2.4	mA
Transconductance, Grid No.1	3200	μ mhos
Transconductance, Grid No.3	390	μ mhos
Plate Resistance (Approx.)	0.17	megohm
Grid-No.1 Voltage (Approx.) for plate current of 75 μ A	-3.5	volts
Grid-No.3 Voltage (Approx.) for plate current of 85 μ A	-5.5	volts
Amplification Factor	67	

MAXIMUM CIRCUIT VALUES

Grid-No.3-Circuit Resistance	0.68	megohm
Grid-No.1-Circuit Resistance:		
For fixed-bias operation	0.22	megohm
For cathode-bias operation	0.47	megohm

For replacement use type 6CG3/6BW3/6DQ3. **6BW3**

Refer to chart at end of section. **6BW4**

Refer to chart at end of section. **6BW8**

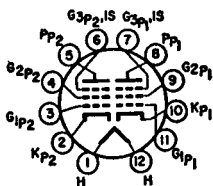

12HD

**SHARP-CUTOFF
DUAL PENTODE**

6BW11

Duodecar type used in color and black-and-white television receiver applications. Unit No. 1 is used as a video amplifier; unit No. 2 is used in bandpass amplifier, burst amplifier, or sound-if or video-if applications. Outlines section, 8B; requires duodecar 12-contact socket. Heater: volts (ac/dc), 6.3; amperes, 0.8; maximum heater-cathode volts, ± 200 peak, 100 average.

Class A₁ Amplifier

MAXIMUM RATINGS (Design-Maximum Values)

	Unit No.1	Unit No.2	
Plate Voltage	330	330	volts
Grid-No.2 (Screen-Grid) Supply Voltage	330	330	volts
Grid-No.2 Voltage	See curve page 300		
Grid-No.1 (Control-Grid) Voltage, Positive-bias value	0	0	volts
Plate Dissipation	4	3.1	watts
Grid-No.2 Dissipation	0.8	0.65	watt

CHARACTERISTICS

Plate Voltage	125	125	volts
Grid No.3 (Suppressor Grid)	Connected to cathode at socket		
Grid-No.2 Voltage	125	125	volts
Cathode-Bias Resistor	56	56	ohms
Plate Resistance (Approx.)	0.12	0.2	megohm
Transconductance	8500	13000	μ mhos
Plate Current	22	11	mA
Grid-No.2 Current	4.8	3.8	mA
Grid-No.1 Voltage (Approx.) for plate current of 20 μ A	-9.5	-3	volts

MAXIMUM CIRCUIT VALUES

Grid-No.1-Circuit Resistance:			
For cathode-bias operation	0.25	0.25	megohm

Refer to chart at end of section. **6BX7GT**

Refer to chart at end of section. **6BY5GA**

6BY6**PENTAGRID AMPLIFIER**

Miniature type used as a gated amplifier in color television receivers. In such service, it may be used as a combined sync separator and sync clipper. Outlines section, 5C; requires miniature 7-contact socket.

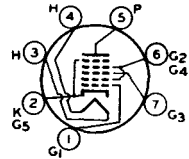
**7CH**

	6BY6	
Heater Voltage (ac/dc)	6.3	volts
Heater Current	0.3	ampere
Heater Warm-up Time (Average)	—	seconds
Peak value	±200 max	volts
Average value	100 max	volts
Direct Interelectrode Capacitances:		
Grid No.1 to Plate	0.08 max	pF
Grid No.3 to Plate	0.35 max	pF
Grid No.1 to Grid No.3	0.22 max	pF
Grid No. 1 to All Other Electrodes	5.4	pF
Grid No.3 to All Other Electrodes	6.9	pF
Plate to All Other Electrodes	7.6	pF

Class A₁ Amplifier**CHARACTERISTICS**

Plate Voltage	250	volts
Grids-No.2-and-No.4 Voltage	100	volts
Grid-No.3 Voltage	—2.5	volts
Grid-No.1 Voltage	—2.5	volts
Grid-No.3-to-Plate Transconductance	500	μmhos
Grid-No.1-to-Plate Transconductance	1900	μmhos
Plate Current	6.5	mA
Grids-No.2-and-No.4 Current	9	mA
Grid-No.3 Volts (Approx.) for plate current of 35 μA and grid-No.1 volts = —4	—15	volts
Grid-No.1 Volts (Approx.) for plate current of 35 μA and grid-No.3 volts = 0	—12	volts

Gated Amplifier**MAXIMUM RATINGS (Design-Maximum Values)**

Plate Voltage	330	volts
Grids-No.2-and-No.4 Voltage	See curve page 300	volts
Grids-No.2-and-No.4 Supply Voltage	330	volts
Grid-No.3 Voltage:		
Negative-bias value	55	volts
Positive-bias value	0	volts
Positive peak value	27	volts
Grid-No.1 Voltage, Negative bias value	110	volts
Plate Dissipation	2.3	watts
Grid-No.3 Input	0.1	watt
Grids-No.2-and-No.4 Input:		
For grids-No.2-and-No.4 voltages up to 165 volts	1.1	watts
For grids-No.2-and-No.4 voltages between 165 and 330 volts	See curve page 300	watts
Grid-No.1 Input	0.1	watt

CHARACTERISTICS AS SYNC SEPARATOR AND SYNC CLIPPER

Plate Voltage	10	volts
Grid-No.3 Voltage	0	volts
Grids-No.2-and-No.4 Voltage	25	volts
Grid-No.1 Voltage	0	volts
Plate Current	1.4	mA
Grids-No.2-and-No.4 Current	3.5	mA
Grid-No.3 Volts (Approx.) for plate voltage of 25 volts, grids-No.2-and-No.4 voltage of 25 volts, grid-No.1 voltage of 0 volts, and plate current of 50 μA	—2.5	volts
Grid-No.1 Volts (Approx.) for plate voltage of 25 volts, grids-No.2-and-No.4 voltage of 25 volts, grid-No.3 voltage of 0 volts, and plate current of 50 μA	—2.3	volts

MAXIMUM CIRCUIT VALUES

Grid-No.1 or Grid-No.3-Circuit Resistance:		
For fixed-bias operation	0.5	megohm
For cathode-bias operation	1	megohm

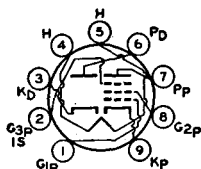
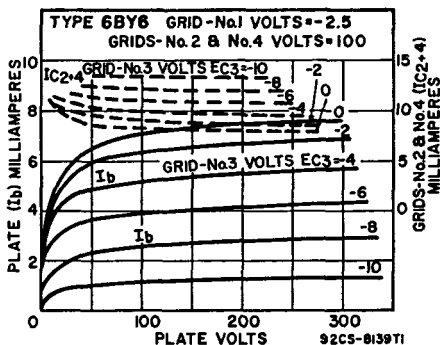

9FN

**DIODE—
SHARP-CUTOFF PENTODE**

6BY8

Miniature type used in television receiver applications. The pentode unit is used as an rf amplifier and the high-perveance diode as a limiter or detector. Outlines section, 6E; requires miniature 9-contact socket.

Heater Voltage (ac/dc)	6.3	volts
Heater Current	0.6	ampere
Heater Warm-up Time (Average)	11	seconds
Heater-Cathode Voltage:		
Peak value	±200 max	volts
Average value	100 max	volts
Direct Interelectrode Capacitances:°		
Pentode Unit:		
Grid No.1 to Plate	0.0035 max	pF
Grid No.1 to Cathode, Heater, Grid No.2, Grid No.3, and Internal Shield	5.5	pF
Plate to Cathode, Heater, Grid No.2, Grid No.3, and Internal Shield	5	pF
Diode Plate to All Other Electrodes	4.8*	pF
° With external shield connected to cathode of pentode unit (pin 9), except as noted.		
* With external shield connected to ground.		

Pentode Unit as Class A₁ Amplifier

MAXIMUM RATINGS (Design-Center Values)

Plate Voltage	300	volts
Grid-No.3 (Suppressor-Grid) Voltage, Positive value	0	volts
Grid-No.2 (Screen Grid) Supply Voltage	300	volts
Grid-No.2 Voltage	See curve page 300	
Grid-No.1 (Control-Grid) Voltage:		
Negative-bias value	50	volts
Positive-bias value	0	volts
Plate Dissipation	3	watts
Grid-No.2 Input:		
For grid-No.2 voltages up to 150 volts	0.65	watt
For grid-No.2 voltages between 150 and 300 volts	See curve page 300	

CHARACTERISTICS

Plate Supply Voltage	100	250	volts
Grid No.3	Connected to cathode at socket		
Grid-No.2 Supply Voltage	100	150	volts
Cathode-Bias Resistor	150	68	ohms
Plate Resistance (Approx.)	0.5	1	megohm
Transconductance	3900	5200	μmhos
Plate Current	5	10.6	mA
Grid-No.2 Current	2.1	4.3	mA
Grid-No.1 Voltage (Approx.) for plate current of 10 μA	-4.2	-6.5	volts

MAXIMUM CIRCUIT VALUES

Grid-No.1-Circuit Resistance:		
For fixed-bias operation	0.25	megohm
For cathode-bias operation	1	megohm

Diode Unit

MAXIMUM RATINGS (Design-Center Values)

Peak Inverse Plate Voltage	430	volts
Peak Plate Current	180	mA
Average Plate Current	45	mA

6BY11

Refer to chart at end of section.

6BZ3

For replacement use type 6BE3/6BZ3.

6BZ6

6BZ6/6JH6

3BZ6, 4BZ6, 12BZ6

**SEMIREMOTE-CUTOFF
PENTODE**

Miniature type used in gain-controlled video if stages of color and black-and-white television receivers. Out-lines section, 5C; requires miniature 7-contact socket. Types 3BZ6, 4BZ6, and 12BZ6 are identical with type 6BZ6 except for heater ratings.

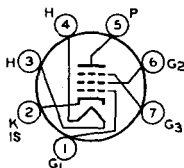

7CM

	3BZ6	4BZ6	6BZ6 6BZ6/6JH6	12BZ6	
Heater Voltage (ac/dc)	3.15	4.2	6.3	12.6	volts
Heater Current	0.6	0.45	0.3	0.15	ampere
Heater Warm-up Time (Average)	11	11	—	—	seconds
Heater-Cathode Voltage:					
Peak value	±200 max	±200 max	±200 max	±200 max	volts
Average value	100 max	100 max	100 max	100 max	volts
Direct Interelectrode Capacitances:					
Grid No.1 to Plate	Unshielded			Shielded	
Grid No.1 to Cathode, Heater, Grid No.2, Grid No.3, and Internal Shield	0.025 max			0.015 max	pF
Plate to Cathode, Heater, Grid No.2, Grid No.3, and Internal Shield	7			7	pF
	2			3	pF

Δ With external shield connected to cathode.

Class A₁ Amplifier

MAXIMUM RATINGS (Design-Maximum Values)

Plate Voltage	330	volts
Grid No.3 (Suppressor-Grid) Voltage, Positive value	0	volts
Grid-No.2 (Screen-Grid) Supply Voltage	330	volts
Grid-No.2 Voltage	See curve page 300	
Grid-No.1 (Control-Grid) Voltage, Positive-bias value	0	volts
Plate Dissipation	2.3	watts
Grid-No.2 Input:		
For grid-No.2 voltages up to 165 volts	0.55	watt
For grid-No.2 voltages between 165 and 330 volts	See curve page 300	

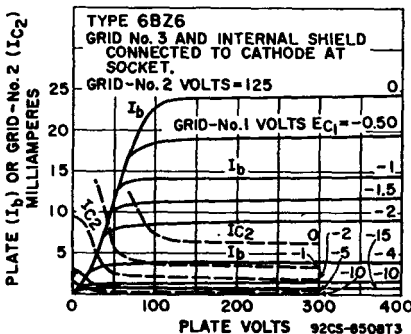

CHARACTERISTICS

Plate Supply Voltage	125	volts
Grid No.3	Connected to cathode at socket	
Grid-No.2 Supply Voltage	125	volts
Cathode-Bias Resistor	56	ohms
Plate Resistance (Approx.)	0.26	megohm
Transconductance	8000	μ mhos
Plate Current	14	mA
Grid-No.2 Current	3.6	mA
Grid-No.1 Voltage (Approx.) for transconductance of 50 μ mhos	-19	volts
Grid-No.1 Voltage (Approx.) for transconductance of 700 μ mhos	-4.5	volts

MAXIMUM CIRCUIT VALUES

Grid-No.1-Circuit Resistance:		
For fixed-bias operation	0.25	megohm
For cathode-bias operation	1	megohm

Refer to chart at end of section.
For replacement use type 6BQ7A/6BZ7/6BS8. **6BZ7**

Refer to chart at end of section.
For replacement use type 6BC8/6BZ8. **6BZ8**

6C4

POWER TRIODE

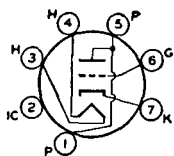

6BG6

Miniature type used as a cascode amplifier in vhf color local oscillator in FM and other high-frequency circuits and as a class C rf amplifier. Outlines section, 5C; requires miniature 7-contact socket. For typical operation as a resistance-coupled amplifier, refer to Resistance-Coupled Amplifier section. For additional curve of plate characteristics, refer to type 12AU7A.

Heater Voltage (ac/dc)	6.3	volts
Heater Current	0.15	ampere
Heater-Cathode Voltage:		
Peak value	± 200 max	volts
Average value	100 max	volts
Direct Interelectrode Capacitances (Approx.)	Unshielded	Shielded ^Δ
Grid to Plate	1.6	1.4
Grid to Cathode and Heater	1.8	1.8
Plate to Cathode and Heater	1.3	2.5

^Δ With external shield connected to cathode.

Class A₁ Amplifier

MAXIMUM RATINGS (Design-Center Values)

Plate Voltage	300 max	volts
Plate Dissipation	3.5 max	watts

CHARACTERISTICS

Plate Voltage	100	250	volts
Grid Voltage*	0	-8.5	volts
Amplification Factor	19.5	17	
Plate Resistance (Approx.)	6250	7700	ohms
Transconductance	3100	2200	μ mhos
Plate Current	11.8	10.5	mA
Grid Voltage (Approx.) for plate current of 10 μ A	-10	-25	volts

MAXIMUM CIRCUIT VALUES

Grid-Circuit Resistance:		
For fixed bias operation	0.25	megohm
For cathode-bias operation	1	megohm

* Transformer- or impedance-type input coupling devices are recommended to minimize resistance in the grid circuit.

RF Power Amplifier and Oscillator—Class C Telegraphy

MAXIMUM RATINGS (Design-Center Values)

Plate Voltage	300	volts
Grid Voltage	-50	volts
Plate Current	25	mA
Grid Current	8	mA
Plate Dissipation	5	watts

TYPICAL OPERATION AT FREQUENCIES UP TO 50 MHz

Plate Voltage	300	volts
Grid Voltage	-27	volts
Plate Current	25	mA
Grid Current (Approx.)	7	mA
Driving Power (Approx.)	0.35	watt
Power Output (Approx.)*	5.5	watts

* Approximately 2.5 watts power output can be obtained when the 6C4 is used at 150 MHz as an oscillator with grid resistor of 10,000 ohms and with maximum rated input.

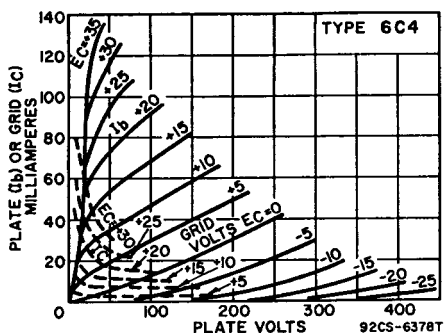

6C5

Refer to chart at end of section.

6C5GT

Refer to chart at end of section.

6C6

Refer to chart at end of section.

6C7

Refer to chart at end of section.

6C8G

Refer to chart at end of section.

6C9

17C9

SHARP-CUTOFF
DUAL TETRODE

Miniature type used as vhf rf-amplifier and autodyne mixer tube. Outlines section, 6B; except center pin is added to base; requires miniature 10-contact socket. Type 17C9 is identical with type 6C9 except for heater ratings.

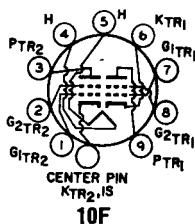

	6C9	17C9	
Heater Voltage (ac/dc)	6.3	16.8	volts
Heater Current	0.4	0.15	ampere
Peak Heater-Cathode Voltage	±100 max	±100 max	volts
Direct Interelectrode Capacitances:	Unit No. 1	Unit No. 2	
Grid No.1 to Plate	0.055 max	0.06 max	pF
Grid No.1 to Cathode, Heater, Grid No.2, and Internal Shield	4.4	4.2	pF
Plate to Cathode, Heater, Grid No.2 and Internal Shield	2.2	2.2	pF
Heater to Cathode	4.2	4.8	pF
Plate of Unit No.1 to Plate of Unit No.2	0.003 max		pF
Grid No.1 of Unit No.1 to Grid No.1 of Unit No.2	0.001 max		pF
Grid No.1 of Unit No.1 to Plate of Unit No.2	0.001 max		pF
Grid No.1 of Unit No.2 to Plate of Unit No.1	0.032 max		pF

Class A₁ Amplifier (Each Unit)

MAXIMUM RATINGS (Design-Maximum Values)

Plate Voltage	250	volts
Grid-No.2 (Screen-Grid) Supply Voltage	180	volts
Grid-No.2 Voltage	See curve page 300	
Cathode Current	20	mA
Plate Dissipation:		
Either plate	1.5	watts
Both plates (both units operating)	2.5	watts
Grid-No.2 Input:		
For grid-No.2 voltages up to 90 volts	0.5	watt
For grid-No.2 voltages between 90 and 180 volts	See curve page 300	

CHARACTERISTICS

Plate Voltage	125	volts
Grid-No.2 Voltage	80	volts
Grid-No.1 Voltage	-1	volt
Plate Resistance (Approx.)	0.1	megohm
Transconductance	8000	μmhos
Plate Current	10	mA
Grid-No.2 Current	1.5	mA
Grid-No.1 Voltage (Approx.) for plate current of 20 μA	-6	volts

Refer to chart at end of section.

6C10

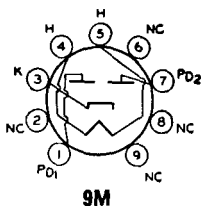

9M

FULL-WAVE VACUUM RECTIFIER

6CA4

Miniature type used in power supply of compact audio equipment having moderate dc requirements. Outlines section, 6G; requires miniature 9-contact socket. This tube, like other power-handling tubes, should be adequately ventilated. Heater: volts (ac/dc), 6.3; amperes, 1.

Full-Wave Rectifier

MAXIMUM RATINGS (Design-Center Values)

Peak Inverse Plate Voltage	1000	volts
Peak Plate Current (Per Plate)	450	mA
AC Plate Supply Voltage (Per Plate, rms) with Capacitor Input to Filter	350	volts
Average Output Current	150	mA
Hot Switching Transient Plate Current (Per Plate)	#	
Peak Heater-Cathode Voltage	-500	volts

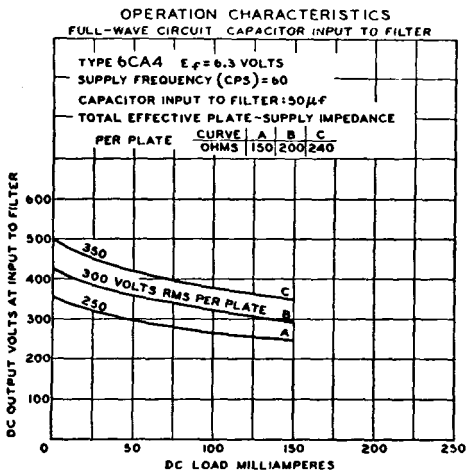

TYPICAL OPERATION WITH CAPACITOR INPUT TO FILTER

AC Plate-to-Plate Supply Voltage (rms)	500	600	700	volts
Filter-Input Capacitor	50	50	50	μ F
Total Effective Plate Supply Impedance per Plate	150	200	240	ohms
DC Output Voltage at Input to Filter (Approx.) For dc output current of 150 mA	245	293	347	volts

When capacitor-input circuits are used, a maximum peak current value per plate of 1 ampere during the initial cycles of the hot-switching transient should not be exceeded.

6CA5

12CA5

BEAM POWER TUBE

Miniature type used in af power output stage of radio and television receivers. Outlines section, 5D; requires miniature 7-contact socket. Type 12CA5 is identical with type 6CA5 except for heater ratings.

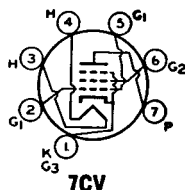

	6CA5	12CA5	
Heater Voltage (ac/dc)	6.3	12.6	volts
Heater Current	1.2	0.6	ampere
Heater Warm-up Time (Average)	—	11	seconds
Heater-Cathode Voltage:			
Peak value	± 200 max	+200 —300 max	volts
Average value	100 max	+100 —200 max	volts

Class A₁ Amplifier

MAXIMUM RATINGS (Design-Center Values)

Plate Voltage	130	volts
Grid-No.2 (Screen-Grid) Voltage	130	volts
Grid-No.1 (Control-Grid) Voltage, Positive-bias value	0	volts
Plate Dissipation	5	watts
Grid-No.2 Input	1.4	watts
Bulb Temperature (At hottest point)	180	$^{\circ}$ C

TYPICAL OPERATION

Plate Voltage	110	125	volts
Grid-No.2 Voltage	110	125	volts
Grid-No.1 (Control-Grid) Voltage	—4	—4.5	volts
Peak AF Grid-No.1 Voltage	4	4.5	volts
Zero-Signal Plate Current	32	37	mA
Maximum-Signal Plate Current	31	36	mA
Zero-Signal Grid-No.2 Current (Approx.)	3.5	4	mA
Maximum-Signal Grid-No.2 Current (Approx.)	7.5	11	mA
Plate Resistance (Approx.)	16000	15000	ohms
Transconductance	8100	9200	μ mhos
Load Resistance	3500	4500	ohms
Total Harmonic Distortion	5	6	per cent
Maximum-Signal Power Output	1.1	1.5	watts

MAXIMUM CIRCUIT VALUES

Grid-No.1-Circuit Resistance:		
For fixed-bias operation	0.1	megohm
For cathode-bias operation	0.5	megohm

6CA7

Refer to chart at end of section.

6CA7/
EL34

POWER PENTODE

Glass octal types used in the output stage of audio-frequency amplifiers. Maximum dimensions: over-all length, $4\frac{7}{16}$ inches; seated height, $3\frac{3}{8}$ inches; diameter, $1\frac{1}{2}$ inches. Tube requires octal socket.

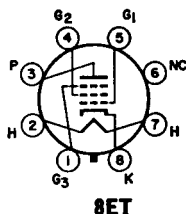

Heater Voltage (ac/dc)	6.3	volts
Heater Current	1.5	amperes
Peak Heater-Cathode Voltage	± 200 max	volts

Direct Interelectrode Capacitances:

Grid No.1 to Plate	1	pF
Grid No.1 to Cathode, Heater, Grid No.2, and Grid No.3	15.5	pF
Plate to Cathode, Heater, Grid No.2, and Grid No.3	7.2	pF

Class A₁ Amplifier

MAXIMUM RATINGS (Design-Center Values)

Plate Voltage	800	volts
Grid-No.2 (Screen-Grid) Voltage	425	volts
Grid-No.2 Input	8	volts
Cathode Current	150	mA
Plate Dissipation	25	watts

TYPICAL OPERATION

Plate Voltage	265	volts
Grid-No.2 Voltage	250	volts
Grid-No.1 (Control-Grid) Voltage	-13.5	volts
Peak AF Grid-No.1 Voltage	12.3	volts
Zero-Signal Plate Current	100	mA
Zero-Signal Grid-No.2 Current	15	mA
Transconductance	11000	μmhos
Plate Resistance	15000	ohms
Load Resistance	2000	ohms
Maximum-Signal Power Output	11	watts
Total Harmonic Distortion	10	per cent

MAXIMUM CIRCUIT VALUE

Grid-No.1-Circuit Resistance, for cathode-bias operation	0.7	megohm
----------------------------------------------------------------	-----	--------

Push-Pull Class AB₁ Amplifier

MAXIMUM RATINGS (Same as for Class A₁ Amplifier)

TYPICAL OPERATION (Values are for two tubes)

Plate Supply Voltage	450	volts
Grid-No.2 Supply Voltage	450	volts
Cathode-Bias Resistor	232	ohms
Grid-No.2 Resistor	1000	ohms
Peak AF Grid-No.1 to Grid-No.1 Voltage	38.2	volts
Zero-Signal Plate Current	120	mA
Maximum-Signal Plate Current	143	mA
Zero-Signal Grid-No.2 Current	20	mA
Maximum-Signal Grid-No.2 Current	44	mA
Effective Load Resistance (Plate-to-plate)	6500	ohms
Total Harmonic Distortion	5.1	per cent
Maximum-Signal Power Output	40	watts

Refer to chart at end of section.

6CB5

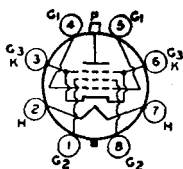

8GD

BEAM POWER TUBE

6CB5A

Glass octal type used as horizontal-deflection amplifier in color and black-and-white television receivers. Outlines section, 21B; requires octal socket.

Heater Voltage (ac/dc)	6.3	volts
Heater Current	2.5	amperes
Heater-Cathode Voltage:		
Peak value	±200 max	volts
Average value	100 max	volts
Direct Interelectrode Capacitances (Approx.):		
Grid No.1 to Plate	0.4	pF
Grid No.1 to Cathode, Heater, Grid No.2, and Grid No.3	22	pF
Plate to Cathode, Heater, Grid No.2, and Grid No.3	10	pF

Class A₁ Amplifier

CHARACTERISTICS

Plate Voltage	75	175	volts
Grid-No.2 Voltage	150	175	volts
Grid-No.1 Voltage	0	-30	volts

Mu-Factor, Grid No.2 to Grid No.1	—	3.8	
Plate Resistance (Approx.)	—	5000	ohms
Transconductance	—	8800	μmhos
Plate Current	460*	90	mA
Grid-No.2 Current	42*	6	mA
Grid-No.1 Voltage (Approx.) for plate current of 1 mA	—	—60	volts

* These values can be measured by a method involving a recurrent waveform such that the maximum rating of the tube will not be exceeded.

Horizontal-Deflection Amplifier

For operation in a 525-line, 30-frame system

MAXIMUM RATINGS (Design-Maximum Values)

DC Plate Voltage	880	volts
Peak Positive-Pulse Plate Voltage#	6800	volts
Peak Negative-Pulse Plate Voltage	1650	volts
DC Grid-No.2 (Screen-Grid) Voltage	220	volts
DC Grid-No.1 (Control-Grid) Voltage	—55	volts
Peak Negative-Pulse Grid-No.1 Voltage	220	volts
Peak Cathode Current	850	mA
Average Cathode Current	240	mA
Grid-No.2 Input	4	watts
Plate Dissipation†	26	watts
Bulb Temperature (At hottest point)	220	°C

MAXIMUM CIRCUIT VALUE

Grid-No.1-Circuit Resistance	0.47	megohm
------------------------------------	------	--------

Pulse duration must not exceed 15% of a horizontal scanning cycle (10 microseconds).

† A bias resistor or other means is required to protect the tube in absence of excitation.

6CB6

Refer to chart at end of section.

For replacement use type 6CB6A/6CF6.

6CB6A

For replacement use type 6CB6A/6CF6.

**6CB6A/
6CF6**

3CB6/3CF6, 4CB6

SHARP-CUTOFF PENTODE

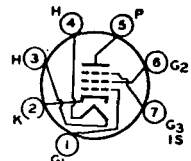

7CM

Miniature types used in color and black-and-white television receivers as if amplifier at frequencies up to about 45 MHz and as rf amplifiers in vhf television tuners. Outlines section, 5C; requires miniature 7-contact socket. For typical operation as resistance-coupled amplifiers, refer to Resistance-Coupled Amplifier section. Types 3CB6/3CF6, and 4CB6 are identical with type 6CB6A/6CF6 except for heater ratings.

Heater Voltage (ac/dc)	3CB6/3CF6	4CB6	6CB6A/6CF6	
Heater Current	3.15	4.2	6.3	volts
Heater Warm-up Time (Average)	0.6	0.45	0.3	ampere
Heater-Cathode Voltage:	11	11	11	seconds
Peak value	{ +200 max -300 max 100 max	{ +200 max -300 max +100 max -200 max	±200 max	volts
Average value			100 max	100 max
Direct Interelectrode Capacitances:		Unshielded	Shielded[▲]	
Grid No.1 to Plate		0.025 max	0.015 max	pF
Grid No.1 to Cathode, Heater, Grid No.2, Grid No.3, and Internal Shield		6.5	6.5	pF
Plate to Cathode, Heater, Grid No.2, Grid No.3, and Internal Shield		2	3	pF

▲ With external shield connected to cathode.

Class A₁ Amplifier

MAXIMUM RATINGS (Design-Maximum Values)

Plate Voltage	330	volts
Grid-No.3 (Suppressor-Grid) Voltage, Positive value	0	volts
Grid-No.2 (Screen-Grid) Voltage	See curve page 300	

Grid-No.2 Supply Voltage	330	volts
Grid-No.1 (Control-Grid) Voltage, Positive-bias value	0	volts
Plate Dissipation	2.3	watts
Grid-No.2 Input:		
For grid-No.2 voltages up to 165 volts	0.55	watt
For grid-No.2 voltages between 165 and 330 volts	See curve page 300	

CHARACTERISTICS

Plate Supply Voltage	125	volts
Grid No.3	Connected to cathode at socket	
Grid-No.2 Supply Voltage	125	volts
Cathode-Bias Resistor	56	ohms
Plate Resistance (Approx.)	0.28	megohm
Transconductance	8000	μ mhos
Plate Current	13	mA
Grid-No.2 Current	3.7	mA
Grid-No.1 Voltage (Approx.) for plate current of 20 μ A	-6.5	volts
Grid-No.1 Voltage (Approx.) for plate current of 2.8 mA	-3	volts

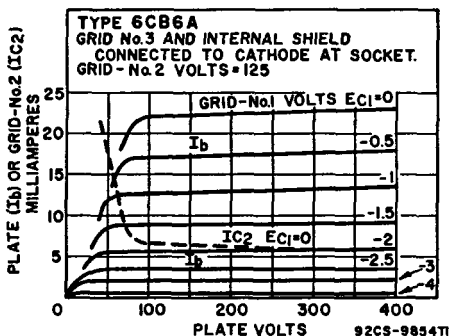

For replacement use type 6CE3/6CD3/6DT3.

Refer to chart at end of section.

6CD3

6CD6G

6CD6GA

25CD6GB

BEAM POWER TUBE

Glass octal type used as horizontal-deflection amplifier in high-efficiency deflection circuits of color and black-and-white television receivers. Outlines section, 21B; requires octal socket. This type may be supplied with pins 1, 4, and 6 omitted. Vertical tube mounting is preferred, but horizontal operation is permissible if pins No.2 and 7 are in vertical plane. Type 25CD6GB is identical with type 6CD6GA except for heater ratings.

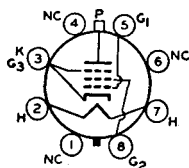

Heater Voltage (ac/dc)	6.3	25	volts
Heater Current	2.5	0.6	amperes
Heater Warm-up Time (Average)	—	11	seconds
Heater-Cathode Voltage:			
Peak value	± 200 max	± 200 max	volts
Average value	100 max	100 max	volts
Direct Interelectrode Capacitances (Approx.):			
Grid No.1 to Plate		1.1	pF
Grid No.1 to Cathode, Heater, Grid No.2, and Grid No.3		22	pF
Plate to Cathode, Heater, Grid No.2, and Grid No.3		8.5	pF

Class A₁ Amplifier

Plate Voltage	60	175	volts
Grid-No.2 (Screen-Grid) Voltage	100	175	volts
Grid-No.1 (Control-Grid) Voltage	0	-30	volts
Mu-Factor, Grid No.2 to Grid No.1	—	3.9	

Plate Resistance (Approx.)	—	7200	ohms
Transconductance	—	7700	μ mhos
Plate Current	230*	5.5	mA
Grid-No.2 Current	21*	5.5	mA
Grid-No.1 Voltage (Approx.) for plate current of 1 mA	—	—55	volts

* This value can be measured by a method involving a recurrent waveform such that the maximum ratings of the tube will not be exceeded.

Horizontal-Deflection Amplifier

For operation in a 525-line, 30-frame system

MAXIMUM RATINGS (Design-Center Values)

DC Plate Voltage	700	volts
Peak Positive-Pulse Plate Voltage* (Absolute Maximum)	7000*	volts
Peak Negative-Pulse Plate Voltage	1500	volts
DC Grid-No.2 (Screen-Grid) Voltage	175	volts
Peak Negative-Pulse Grid-No.1 Voltage	700	volts
Peak Cathode Current	200	mA
Average Cathode Current	—200	mA
Plate Dissipation†	20	watts
Grid-No.2 Input	3	watts
Bulb Temperature (At hottest point)	225	°C

MAXIMUM CIRCUIT VALUE

Grid-No.-Circuit Resistance, for grid-resistor-bias operation 0.47 megohm

Pulse duration must not exceed 15% of a horizontal scanning cycle (10 microseconds).

* Under no circumstances should this absolute value be exceeded.

† A bias resistor or other means is required to protect the tube in absence of excitation.

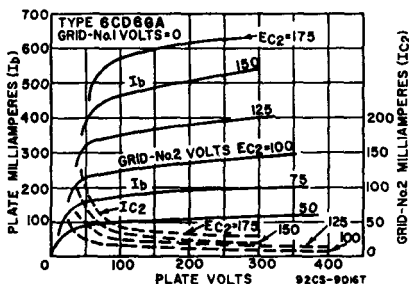

6CE3

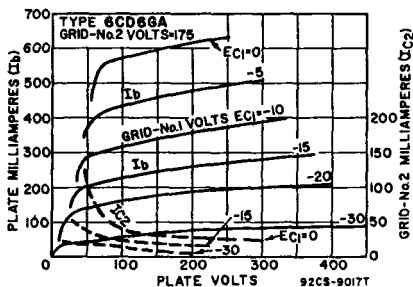

Refer to chart at end of section.

For replacement use type 6CE3/6CD3/6DT3.

6CE3/ 6CD3/6DT3

34CE3

HALF-WAVE VACUUM RECTIFIER

Duodecar type used as a damper diode in the horizontal-deflection circuit of color television receivers. Outlines section, 8G; requires duodecar 12-contact socket. Type 34CE3 is identical with type 6CE3/6CD3/6DT3 except for heater ratings.

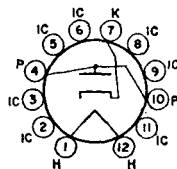

12GK

Heater Voltage (ac/dc)	6CE3/ 6CD3/6DT3	34CE3	volts
Heater Current	6.8	34.5	amperes
Heater Warm-up Time (Average)	2.5	0.45	seconds
Direct Interelectrode Capacitances:			
Plate to Cathode and Heater		13	pF
Cathode to Plate and Heater		18	pF
Heater to Cathode		5.5	pF

Damper Service

For operation in a 525-line, 30-frame system

MAXIMUM RATINGS (Design-Maximum Values)

Peak Inverse Plate Voltage#	5000	volts
Peak Plate Current	1500	mA
Average Plate Current	350	mA
Plate Dissipation	11	watts
Bulb Temperature (At hottest point)	220	°C
Heater-Cathode Voltage:		
Peak value	+300	-5500
Average value	+100	-900
		volts

CHARACTERISTIC, Instantaneous Value

Tube Voltage Drop for plate current of 680 mA	20	volts
-----------------------------------------------	----	-------

Pulse duration must not exceed 15% of a horizontal scanning cycle (10 microseconds).

6CE5

Refer to chart at end of section.
For replacement use type 6BC5/6CE5.

6CF6

Refer to chart at end of section.
For replacement use type 6CB6A/6CF6.

6CG3

For replacement use type 6CG3/6BW3/6DQ3.

6CG3/6BW3

For replacement use type 6CG3/6BW3/6DQ3.

**6CG3/
6BW3/
6DQ3**

**HALF-WAVE
VACUUM RECTIFIER**

19CG3/19DQ3, 25CG3

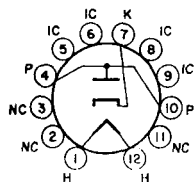

12FX

Duodecar type used as damper diode in horizontal-deflection circuits of color and black-and-white television receivers. Outlines section, 8G, requires duodecar 12-contact socket. Types 19CG3/19DQ3 and 25CG3 are identical with type 6CG3 except for heater ratings.

	6CG3/ 6BW3/6DQ3	19CG3/ 19DQ3	25CG3	
Heater Voltage (ac/dc)	6.3	19	25	volts
Heater Current	1.8	0.6	0.45	amperes
Heater Warm-up Time	—	11	11	seconds

Damper Service

For operation in a 525-line, 30-frame system

MAXIMUM RATINGS (Design-Maximum Values)

Peak Inverse Plate Voltage#	5000	volts
Peak Plate Current	2100	mA
Average Plate Current	350	mA
Plate Dissipation	6.5	watts
Heater-Cathode Voltage:		
Peak value	+300	-5000
Average value	+100	-900
		volts

CHARACTERISTIC, Instantaneous Value

Tube Voltage Drop for plate current of 700 mA	25	volts
-----------------------------------------------	----	-------

Pulse duration must not exceed 15% of a horizontal scanning cycle (10 microseconds).

Refer to chart at end of section.
For replacement use type 6CG3/6BW3/6DQ3.

6CG3/6CD3

For replacement use type 6FQ/6CG7.

6CG7

Refer to chart at end of section.

6CG8

6CG8A

5CG8

**MEDIUM-MU TRIODE—
SHARP-CUTOFF PENTODE**

Miniature type used as combined oscillator and mixer tube in color and black-and-white television receivers utilizing an intermediate frequency in the order of 40 MHz. When used in an AM/FM receiver, the triode unit is used as an oscillator for both sections. In the AM section, the pentode unit is used as a high-gain pentode mixer; in the FM section, the pentode unit is used either as a pentode mixer or as a triode-connected mixer depending on signal-to-noise considerations. **Outlines section, 6B**; requires miniature 9-contact socket. Type 5CG8 is identical with type 6CG8A except for heater ratings. These types are electrically identical with miniature type 6X8 except for inter-electrode capacitances.

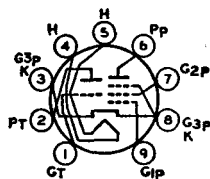
**9GF**

Heater Voltage (ac/dc)	5CG8 4.7	6CG8A 6.3	volts
Heater Current	0.6	0.45	ampere
Heater Warm-up Time (Average)	11	11	seconds
Heater-Cathode Voltage:			
Peak value	±200 max	±200 max	volts
Average value	100 max	100 max	volts
Direct Interelectrode Capacitances:	Unshielded	Shielded*	
Triode Unit:			
Grid to Plate	1.5	1.5	pF
Grid to Cathode, Heater, and Pentode Grid No.3	2	2.4	pF
Plate to Cathode, Heater, and Pentode Grid No.3	0.5	1	pF
Pentode Unit:			
Grid No.1 to Plate	0.04 max	0.02 max	pF
Grid No.1 to Cathode, Heater, Grid No.2, and Grid No.3	4.6	4.8	pF
Plate to Cathode, Heater, Grid No.2, and Grid No.3	0.9	1.6	pF
Pentode Grid No.1 to Triode Plate	0.05 max	0.04 max	pF
Pentode Plate to Triode Plate	0.05 max	0.008 max	pF
Heater to Cathode	6.5	6.5*	pF

* With external shield connected to cathode, except as noted.

* With external shield connected to plate.

6CH3

For replacement use type 6CJ3/6CH3.

6CH8

Refer to chart at end of section.

6CJ3

For replacement use type 6CJ3/6CH3.

6CJ3/6CH3**HALF-WAVE
VACUUM RECTIFIER**

Novar type used as damper tube in horizontal-deflection circuits of black-and-white television receivers. **Outlines section, 30F**; requires novar 9-contact socket. Socket terminals 1, 3, 6, and 8 should not be used as tie points. This tube, like other power-handling tubes, should be adequately ventilated. Heater: volts (ac/dc), 6.3; amperes, 1.8.

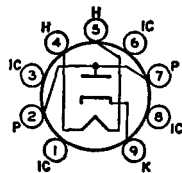
**9HP****Damper Service**

For operation in a 525-line, 30-frame system

MAXIMUM RATINGS (Design-Maximum Values)

Peak Inverse Plate Voltage#	5500	volts
Peak Plate Current	2100	mA
Average Plate Current	350	mA
Plate Dissipation	6.5	watts
Heater-Cathode Voltage:		
Peak value	+300	—5500
Average value	+100	—900
		volts
		volts

CHARACTERISTICS, Instantaneous Value

Tube Voltage Drop for plate current of 700 mA	25	volts
# Pulse duration must not exceed 15% of a horizontal scanning cycle (10 microseconds).		

Refer to chart at end of section.
For replacement use type 6CL3/6CK3. **6CK3**

Refer to chart at end of section.
For replacement use type 6CL3/6CK3. **6CK4**
6CL3

**HALF-WAVE
VACUUM RECTIFIER**

6CL3/6CK3
12CL3

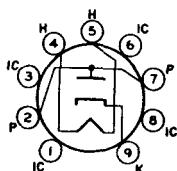

9HP

Novar type used as a damper tube in horizontal-deflection circuits of color and black-and-white television receivers. **Outlines section, 30B**; requires novar 9-contact socket. Socket terminals 1, 3, 6, and 8 should not be used as tie points. This tube, like other power-handling tubes, should be adequately ventilated. Type 12CL3 is identical with type 6CL3/6CK3 except for heater ratings.

	6CL3/6CK3	12CL3	
Heater Voltage (ac/dc)	6.3	12.6	volts
Heater Current	1.2	0.6	amperes
Heater Warm-up Time (Average)	—	11	seconds
Direct Interelectrode Capacitances:			
Plate to Cathode and Heater		6.5	pF
Cathode to Plate and Heater		9	pF
Heater to Cathode		3	pF

Damper Service

For operation in a 525-line, 30-frame system

MAXIMUM RATINGS (Design-Maximum Values)

Peak Inverse Plate Voltage#	5500	volts	
Peak Plate Current	1300	mA	
Average Plate Current	250	mA	
Plate Dissipation	8.5	watts	
Bulb Temperature (At hottest point)	220	°C	
Heater-Cathode Voltage:			
Peak value	+300	—5000	volts
Average value	+100	—900	volts

CHARACTERISTICS, Instantaneous Value

Tube Voltage Drop for plate current of 350 mA	16	volts
# Pulse duration must not exceed 15% of a horizontal scanning cycle (10 microseconds).		

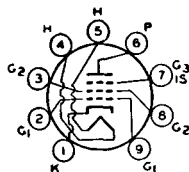

9BV

POWER PENTODE

6CL6

Miniature type used in output stage of video amplifier of color and black-and-white television receivers and as wide-band amplifier tube in industrial and laboratory equipment. **Outlines section, 6E**; requires miniature 9-contact socket.

Heater Voltage (ac/dc)	6.3	volts
Heater Current	0.65	ampere
Peak Heater-Cathode Voltage	±100 max	volts
Direct Interelectrode Capacitances (Approx.):		
Grid No.1 to Plate	0.12	pF
Grid No.1 to Cathode, Heater, Grid No.2, Grid No.3, and Internal Shield	11	pF
Plate to Cathode, Heater, Grid No.2, Grid No.3, and Internal Shield	5.5	pF

Class A₁ Amplifier

MAXIMUM RATINGS (Design-Center Values)

Plate Voltage	300	volts
Grid-No.3 (Suppressor-Grid) Voltage, Positive value	0	volts
Grid-No.2 (Screen-Grid) Supply Voltage	300	volts
Grid-No.2 Voltage	150	volts
Grid-No.1 (Control-Grid) Voltage:		
Negative-bias value	50	volts
Positive-bias value	0	volts
Plate Dissipation	7.5	watts
Grid-No.2 Input	1.7	watts
Bulb Temperature (At hottest point)	200	°C

TYPICAL OPERATION

Plate Voltage	250	volts
Grid No.3	Connected to cathode at socket	
Grid-No.2 Voltage	150	volts
Grid-No.1 Voltage	-3	volts
Peak AF Grid-No.1 Voltage	3	volts
Zero-Signal Plate Current	30	mA
Maximum-Signal Plate Current	31	mA
Zero-Signal Grid-No.2 Current	7	mA
Maximum-Signal Grid-No.2 Current	7.2	mA
Plate Resistance (Approx.)	0.09	megohm
Transconductance	11000	μmhos
Load Resistance	7500	ohms
Total Harmonic Distortion	8	per cent
Maximum-Signal Power Output	2.8	watts
Grid-No.1 Voltage (Approx.) for plate current of 10 mA	-14	volts

TYPICAL OPERATION IN MHz-BANDWIDTH VIDEO AMPLIFIER

Plate Supply Voltage	300	volts
Grid No.3	Connected to cathode at socket	
Grid-No.2 Supply Voltage	300	volts
Grid-No.1 Bias Voltage	-2	volts
Grid-No.1 Signal Voltage (Peak to Peak)	3	volts
Grid-No.2 Resistor	24000	ohms
Grid-No.1 Resistor	0.1	megohm
Load Resistor	3900	ohms
Zero-Signal Plate Current	30	mA
Zero-Signal Grid-No.2 Current	7	mA
Voltage Output (Peak to Peak)	132	volts

MAXIMUM CIRCUIT VALUES

Grid-No.1 Circuit Resistance:		
For fixed-bias operation	0.1	megohm
For cathode-bias operation	0.5	megohm

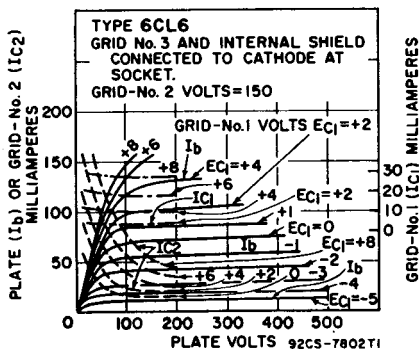

6CL8

Refer to chart at end of section.

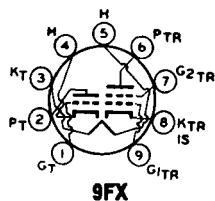

**MEDIUM-MU TRIODE—
SHARP-CUTOFF TETRODE**

6CL8A

5CL8A

Miniature type used as combined vhf oscillator and mixer in color and black-and-white television receivers. Outlines section, 6B; requires miniature 9-contact socket. For maximum ratings as class A₁ amplifier, see type 6U8A. Type 5CL8A is identical with type 6CL8A except for heater ratings.

Heater Voltage (ac/dc)	5CL8A 4.7	6CL8A 6.3	volts
Heater Current	0.6	0.45	ampere
Heater Warm-up Time (Average)	11	11	seconds
Heater-Cathode Voltage:			
Peak value	±200 max	±200 max	volts
Average value	100 max	100 max	volts
Direct Interelectrode Capacitances:			
Triode Unit:			
Grid to Plate	1.8	1.8	pF
Grid to Cathode, Tetrode Cathode, Heater, and Internal Shield	2.8	2.8	pF
Plate to Cathode, Tetrode Cathode, Heater, and Internal Shield	1.5	2	pF
Tetrode Unit:			
Grid No. 1 to Plate	0.02 max	0.01 max	pF
Grid No.1 to Cathode, Heater, Grid No.2, and Internal Shield	5	5	pF
Plate to Cathode, Heater, Grid No.2, and Internal Shield	2	3	pF
Tetrode Grid No.1 to Triode Plate	0.015 max	0.01 max	pF
Tetrode Plate to Triode Plate	0.15 max	0.03 max	pF
Heater to Cathode (Each Unit)	3	3	pF

Class A₁ Amplifier

CHARACTERISTICS

	Triode Unit	Tetrode Unit	
Plate Supply Voltage	125	125	volts
Grid-No.2 (Screen-Grid) Voltage	—	125	volts
Grid-No.1 Voltage	—1	—1	volt
Amplification Factor	40	—	
Plate Resistance (Approx.)	0.005	0.2	megohm
Transconductance	8000	6500	μmhos
Plate Current	14	12	mA
Grid-No.2 Current	—	4	mA
Grid-No.1 Voltage (Approx.) for plate current of 20 μA	—9	—9	volts

MAXIMUM CIRCUIT VALUES

Grid-No.1-Circuit Resistance:			
For fixed-bias operation	0.5	0.25	megohm
For cathode-bias operation	1	1	megohm

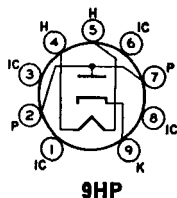

**HALF-WAVE
VACUUM RECTIFIER**

6CM3

Novar type used as damper tube in horizontal-deflection circuits of color and black-and-white television receivers. Outline section, 30B; requires novar 9-contact socket. Socket terminals 1, 3, 6, and 8 should not be used as tie points. This tube, like other power-handling tubes, should be adequately ventilated.

Heater Voltage (ac/dc)	6.3	volts
Heater Current	2.4	ampere
Direct Interelectrode Capacitances:		
Plate to Cathode and Heater	20	pF
Cathode to Plate and Heater	18	pF
Heater to Cat' de	4	pF

Damper Service

For operation in a 525-line, 30-frame system

MAXIMUM RATINGS (Design-Maximum Values)

Peak Inverse Plate Voltage#	5500	volts
Peak Plate Current	1700	mA
Average Plate Current	400	mA
Plate Dissipation	12	watts
Heater-Cathode Voltage:		
Peak value	+300	—5500
Average value	+100	—900
		volts

CHARACTERISTIC, Instantaneous Value

Tube Voltage Drop for plate current of 350 mA	10	volts
-----------------------------------------------	----	-------

Pulse duration must not exceed 15% of a horizontal scanning cycle (10 microseconds).

6CM6

Refer to chart at end of section.

6CM7

8CM7

MEDIUM-MU DUAL TRIODE

Miniature type used as combined vertical-deflection oscillator and vertical-deflection amplifier in black-and-white television receivers. Unit No.1 is used as a conventional blocking oscillator in vertical-deflection circuits, and unit No.2 as a vertical-deflection amplifier. Outlines section, 6E; requires miniature 9-contact socket. Types 8CM7 is identical with type 6CM7 except for heater ratings.

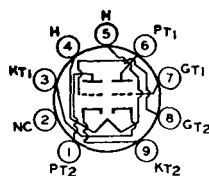

9ES

	6CM7	8CM7	
Heater Voltage (ac/dc)	6.3	8.4	volts
Heater Current	0.6	0.45	ampere
Heater Warm-up Time (Average)	11	11	seconds
Heater-Cathode Voltage:			
Peak value	±200 max	±200 max	volts
Average value	100 max	100 max	volts
Direct Interelectrode Capacitances (Approx.):			
	Unit No.1	Unit No.2	
Grid to Plate	3.8	3	pF
Grid to Cathode and Heater	2	3.5	pF
Plate to Cathode and Heater	0.5	0.4	pF

Class A₁ Amplifier

CHARACTERISTICS

	Unit No.1	Unit No.2	
Plate Voltage	200	250	volts
Grid Voltage	-7	-8	volts
Amplification Factor	21	18	
Plate Resistance (Approx.)	10500	4100	ohms
Transconductance	2000	4400	μmhos
Plate Current	5	20	mA
Plate Current for grid voltage of -10 volts	1	—	mA
Grid Voltage (Approx.) for plate current of 10 μA	-14	—	volts

Vertical-Deflection Oscillator and Amplifier

For operation in a 525-line, 30-frame system

MAXIMUM RATINGS (Design-Maximum Values)

	Unit No.1 Oscillator	Unit No.2 Amplifier	
DC Plate Voltage	550	550	volts
Peak Positive-Pulse Plate Voltage#	—	2200	volts
Peak Negative-Pulse Grid Voltage	220	220	volts
Peak Cathode Current	77	77	mA
Average Cathode Current	17	22	mA
Plate Dissipation	1.45	6	watts

MAXIMUM CIRCUIT VALUES

Grid-Circuit Resistance:			
For fixed-bias operation	2.2	1	megohms
For cathode-bias operation	2.2	2.5	megohms
For grid-resistor-bias operation	2.2	—	megohms

Pulse duration must not exceed 15% of a vertical scanning cycle (2.5 milliseconds).

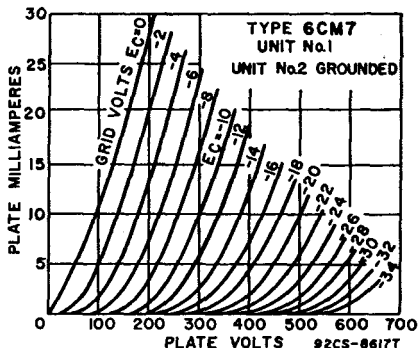
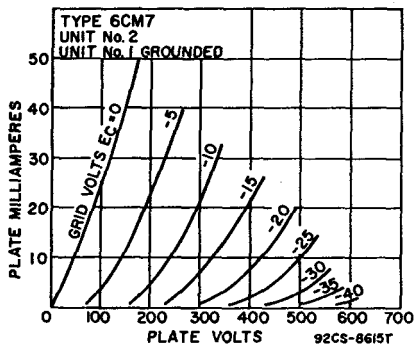

Refer to chart at end of section.

6CM8

TWIN DIODE—
HIGH-MU TRIODE

6CN7

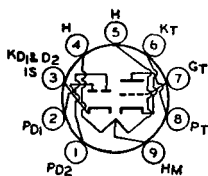

9EN

Miniature type used as combined horizontal phase detector and reactance tube in color and black-and-white television receivers. The triode unit is used in sync-separator, sync-amplifier, or audio amplifier circuits. Outlines section, 6B; requires miniature 9-contact socket. For typical operation of triode unit as resistance-coupled amplifier, refer to Resistance-Coupled Amplifier section.

Heater Voltage (ac/dc):		
Series	6.3	volts
Parallel	3.15	volts
Heater Current:		
Series	0.3	ampere
Parallel	0.6	ampere
Heater Warm-up Time (Average)		
	11	seconds
Heater-Cathode Voltage:		
Peak value	±200 max	volts
Average value	100 max	volts
Direct Interelectrode Capacitances:		
Triode Unit:		
Grid to Plate	1.8	pF
Grid to Cathode and Heater	1.5	pF
Plate to Cathode and Heater	0.5	pF
Diode Units:		
Diode-No.1 Plate to Cathode of Diodes No.1 and No. 2, Heater, and Internal Shield	3.6	pF
Diode-No.2 Plate to Cathode of Diodes No.1 and No. 2, Heater, and Internal Shield	3.6	pF
Triode Grid to Either Diode Plate	0.006	pF

Triode Unit as Class A₁ Amplifier

MAXIMUM RATINGS (Design-Maximum Values)

Plate Voltage	330	volts
Grid Voltage, Positive-bias value	0	volts
Plate Dissipation	1.1	watt

CHARACTERISTICS

Plate Voltage	100	250	volts
Grid Voltage	-1	-3	volts
Amplification Factor	70	70	
Plate Resistance (Approx.)	54000	58000	ohms
Transconductance	1300	1200	μmhos
Plate Current	0.8	1	mA

Diode Units

MAXIMUM RATINGS (Design-Maximum Values)

Plate Current (Each Unit)	5.5	mA
---------------------------	-----	----

6CQ4

Refer to chart at end of section.
For replacement use type 6DE4/6CQ4.

6CQ8

MEDIUM-MU TRIODE—
SHARP-CUTOFF TETRODE

Miniature type used in color and black-and-white television receiver applications. The tetrode unit is used as a mixer, video if amplifier, or sound if amplifier tube. The triode unit is used in vhf oscillator, phase-splitter, sync-clipper, sync-separator, and rf amplifier circuits. Outlines section, 6B; requires miniature 9-contact socket.

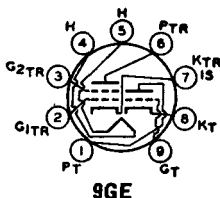

Heater Voltage (ac/dc)	6.3	volts
Heater Current	0.45	ampere
Heater Warm-up Time (Average)	11	seconds
Heater-Cathode Voltage:		
Peak value	±200 max	volts
Average value	100 max	volts
Direct Interelectrode Capacitances:		
	Unshielded	Shielded*
Triode Unit:		
Grid to Plate	1.8	1.8
Grid to Cathode and Heater	2.7	2.7
Plate to Cathode and Heater	0.4	1.2
Tetrode Unit:		
Grid No.1 to Plate	0.019 max	0.015 max
Grid No.1 to Cathode, Heater, Grid No.2 and Internal Shield	5	5
Plate to Cathode, Heater, Grid No.2, and Internal Shield	2.5	3.3
Tetrode Plate to Triode Plate	0.07 max	0.01 max
Heater to Cathode (Each Unit)	3	3†

* With external shield connected to cathode of unit under test.

† With external shield connected to ground.

Class A₁ Amplifier

MAXIMUM RATINGS (Design-Maximum Values)	Triode Unit	Tetrode Unit	
Plate Voltage	330	330	volts
Grid-No.2 (Screen-Grid) Supply Voltage	—	330	volts
Grid-No.2 Voltage	See curve page 300		
Grid-No.1 (Control-Grid) Voltage, Positive-bias value	0	0	volts
Plate Dissipation	3.1	3.2	watts
Grid-No.2 Input:			
For grid-No.2 voltages up to 165 volts	—	0.7	watt
For grid-No.2 voltages between 165 and 330 volts	See curve page 300		
Grid Input	0.55	—	watt

CHARACTERISTICS

Plate-Supply Voltage	125	125	volts
Grid-No.2 Supply Voltage	—	125	volts
Grid-No.1 Voltage	—	—1	volts
Cathode-Bias Resistor	56	—	ohms
Amplification Factor	40	—	
Plate Resistance (Approx.)	5000	140000	ohms
Transconductance	8000	5800	μmhos
Plate Current	15	12	mA
Grid-No.2 Current	—	4.2	mA
Grid-No.1 Voltage (Approx.) for plate current of 100 μA	—7	—7	volts

MAXIMUM CIRCUIT VALUES

Grid-No.1-Circuit Resistance:			
For fixed-bias operation	0.5	0.25	megohm
For cathode-bias operation	1	1	megohm

6CR6

Refer to chart at end of section.

6CS6

PENTAGRID AMPLIFIER

3CS6, 4CS6, 12CS6

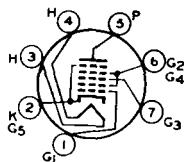

7CH

Miniature type used as a gated amplifier in color and black-and-white television receivers. In such service, it may be used as a combined sync separator and sync clipper. Outlines section, 5C; requires miniature 7-contact socket. Types 3CS6, 4CS6, and 12CS6 are identical with type 6CS6 except for heater ratings.

	3CS6	4CS6	6CS6	12CS6	
Heater Voltage (ac/dc)	3.15	4.2	6.3	12.6	volts
Heater Current	0.6	0.45	0.3	0.15	ampere
Heater Warm-up Time (Average)	11	11	11	—	seconds
Heater-Cathode Voltage:					
Peak value	±200 max	±200 max	±200 max	±200 max	volts
Average value	100 max	100 max	100 max	100 max	volts
Direct Interelectrode Capacitances (Approx.)					
Grid No.1 to Plate				0.07 max	pF
Grid No.3 to Plate				0.36 max	pF
Grid No.1 to Grid No.3				0.22 max	pF
Grid No.1 to Cathode, Heater, Grid No.2, Grid No.3, Grid No.4, and Grid No.5				5.5	pF
Grid No.3 to Cathode, Heater, Grid No.1, Grid No.2, Grid No.4, and Grid No.5				7	pF
Plate to Cathode, Heater, Grid No.1, Grid No.2, Grid No.3, Grid No.4, and Grid No.5				7.5	pF

Class A₁ Amplifier

CHARACTERISTICS

Plate Voltage	100	100	volts
Grids-No.2-and-No.4 Voltage	30	30	volts
Grid-No.3 Voltage	—1	0	volt
Grid-No.1 Voltage	0	—1	volt
Plate Resistance (Approx.)	0.7	1	megohm
Grid-No.3-to-Plate Transconductance	1500	—	μmhos
Grid-No.1-to-Plate Transconductance	—	1100	μmhos
Plate Current	0.8	1	mA
Grids-No.2-and-No.4 Current	5.5	1.3	mA
Grid-No.3 Voltage (Approx.) for plate current of 50 μA	—2.2	—	volts
Grid-No.1 Voltage (Approx.) for plate current of 50 μA	—	—2.5	volts

Gated Amplifier Service

MAXIMUM RATINGS (Design-Center Values)

Plate Voltage	300	volts
Grids-No.2-and-No.4 Supply Voltage	300	volts
Grids-No.2-and-No.4 Voltage	See curve page 300	
Cathode Current	14	mA
Plate Dissipation	1	watt
Grids-No.2-and-No.4 Input:		
For grids-No.2-and-No.4 voltages up to 150 volts	1	watt
For grids-No.2-and-No.4 voltages between 150 and 300 volts	See curve page 300	

MAXIMUM CIRCUIT VALUES

Grid-No.1-Circuit Resistance	0.47	megohm
Grid-No.3-Circuit Resistance	2.2	megohms

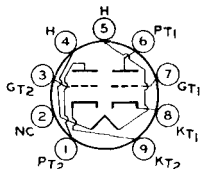

9EF

6CS7

8CS7

MEDIUM-MU DUAL TRIODE

Miniature type used as combined vertical-deflection oscillator and vertical-deflection amplifier in television receivers. Unit No.1 is used as a conventional blocking oscillator in vertical-deflection circuits, and unit No.2 as a vertical-deflection amplifier. Outline section, 6E; requires miniature 9-contact socket. Type 8CS7 is identical with type 6CS7 except for heater ratings.

	6CS7	8CS7	
Heater Voltage (ac/dc)	6.3	8.4	volts
Heater Current	0.6	0.45	ampere
Heater Warm-up Time (Average)	11	11	seconds
Heater-Cathode Voltage:			
Peak value	±200 max	±200 max	volts
Average value	100 max	100 max	volts
Direct Interelectrode Capacitances (Approx.):			
Grid to Plate	2.6	2.6	pF
Grid to Cathode and Heater	1.8	3	pF
Plate to Cathode and Heater	0.5	0.5	pF

Class A₁ Amplifier

CHARACTERISTICS	Unit No.1 Oscillator	Unit No.2 Amplifier	
Plate Voltage	250	250	volts
Grid Voltage	-8.5	-10.5	volts
Amplification Factor	17	15.5	
Plate Resistance (Approx.)	7700	3450	ohms
Transconductance	2200	4500	μmhos
Plate Current	10.5	19	mA
Plate Current for grid voltage of -16 volts	—	3	mA
Grid Voltage (Approx.) for plate current of 10 μA	-24	—	volts
Grid Voltage (Approx.) for plate current of 50 μA	—	-22	volts

Vertical-Deflection Oscillator and Amplifier

For operation in a 525-line, 30-frame system

MAXIMUM RATINGS (Design-Center Values)	Unit No.1 Oscillator	Unit No.2 Amplifier	
DC Plate Voltage	500	500	volts
Peak Positive-Pulse Plate Voltage# (Absolute Maximum)	—	2200 ^Δ	volts
Peak Negative-Pulse Grid Voltage	400	250	volts
Peak Cathode Current	70	105	mA
Average Cathode Current	20	30	mA
Plate Dissipation	1.25	5.5	watts

MAXIMUM CIRCUIT VALUES

Grid-Circuit Resistance	2.2	2.2	megohms
-------------------------------	-----	-----	---------

Pulse duration must not exceed 15% of a vertical scanning cycle (2.5 milliseconds).

Δ Under no circumstances should this absolute value be exceeded.

6CT3

Refer to chart at end of section.

6CU5

12CU5/12C5,
17CU5/17C5

BEAM POWER TUBE

Miniature type used in the audio output stage of television receivers. Outlines section, 5D; requires miniature 7-contact socket. Types 12CU5/12C5, and 17CU5/17C5 are identical with type 6CU5 except for heater ratings.

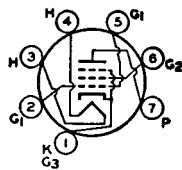

7CV

	6CU5	12CU5/12C5	17CU5/ 17C5	
Heater Voltage (ac/dc)	6.3	12.6	16.8	volts
Heater Current	1.2	0.6	0.45	ampere
Heater Warm-up Time (Average)	—	11	11	seconds
Heater-Cathode Voltage:				
Peak value	±200 max	±200 max	±200 max	volts
Average value	100 max	100 max	100 max	volts
Direct Interelectrode Capacitances (Approx.):				
Grid No.1 to Plate			0.6	pF
Grid No.1 to Cathode, Heater, Grid No.2, and Grid No.3			13	pF
Plate to Cathode, Heater, Grid No.2, and Grid No.3			8.5	pF

Class A₁ Amplifier

MAXIMUM RATINGS (Design-Maximum Values)

Plate Voltage	150	volts
Grid-No.2 (Screen-Grid) Voltage	130	volts
Grid-No.1 (Control-Grid) Voltage, Positive-bias value	0	volts
Plate Dissipation	7	watts
Grid-No.2 Input	1.4	watts
Bulb Temperature (At hottest point)	220	°C

TYPICAL OPERATION

Plate Voltage	120	volts
Grid-No.2 Voltage	110	volts
Grid-No.1 Voltage	-8	volts
Peak AF Grid-No.1 Voltage	8	volts
Zero-Signal Plate Current	49	mA
Maximum-Signal Plate Current	50	mA
Zero-Signal Grid-No.2 Current	4	mA
Maximum-Signal Grid-No.2 Current	8.5	mA
Plate Resistance (Approx.)	10000	ohms
Transconductance	7500	μmhos
Load Resistance	2500	ohms
Total Harmonic Distortion	10	per cent
Maximum-Signal Power Output	2.3	watts

MAXIMUM CIRCUIT VALUES

Grid-No.1-Circuit Resistance:		
For fixed-bias operation	0.1	megohm
For cathode-bias operation	0.5	megohm

For replacement use type 6BQ6GTB/6CU6.

6CU6

Refer to chart at end of section.

6CU8

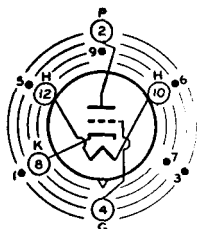

INDEX=LARGE LUG
●=PIN CUT OFF
12AQ

HIGH-MU TRIODE

6CW4

2CW4, 13CW4

Nuvistor type used as a grounded-cathode, neutralized rf amplifier in vhf tuners of color and black-and-white television and FM receivers. Outlines section, 1; requires nuvistor socket. Types 2CW4 and 13CW4 are identical with type 6CW4 except for heater ratings.

Heater Voltage (ac/dc)	2CW4 2.1	6CW4 6.3	13CW4 13.5	volts
Heater Current	0.45	0.135	0.06	ampere
Heater Warm-up Time (Average)	8	—	—	seconds
Peak Heater-Cathode Voltage	±100 max	±100 max	±100 max	volts
Direct Interelectrode Capacitances (Approx.)				
Grid to Plate		0.92		pF
Grid to Cathode, Heater, and Shell		4.3		pF
Plate to Cathode, Heater, and Shell		1.8		pF
Plate to Cathode		0.18		pF
Heater to Cathode		1.6		pF

Class A₁ Amplifier

MAXIMUM RATINGS (Design-Maximum Values)

Plate Supply Voltage	300°	volts
Plate Voltage	135	volts
Grid Voltage:		
Negative-bias value	55	volts
Peak positive value	0	volts
Cathode Current	15	mA
Plate Dissipation	1.5	watt

CHARACTERISTICS AND TYPICAL OPERATION

	Characteristics	Typical Operation	
Plate Supply Voltage	110	70	volts
Grid Supply Voltage	0	0	volts
Cathode-Bias Resistor	130	—	ohms
Grid Resistor	—	47000	ohms
Amplification Factor	65	68	
Plate Resistance (Approx.)	6600	5440	ohms
Transconductance	9800	12500	μ mhos
Plate Current	7	7.2	mA
Grid Voltage (Approx.) for plate current of 10 μ A	-4	—	volts

MAXIMUM CIRCUIT VALUES

Grid-Circuit Resistance:*		
For fixed-bias operation	0.5	megohm
For cathode-bias operation	2.2	megohms

* A plate supply voltage of 300 volts may be used provided a sufficiently large resistor is used in the plate circuit to limit the plate dissipation to 1.5 watts under any condition of operation.

* For operation at metal-shell temperatures up to 135° C.

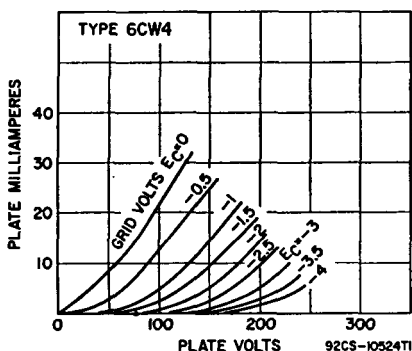

6CW5

Refer to chart at end of section.

6CW5/
EL868CW5/XL86,
10CW5/LL86,
15CW5/PL84

POWER PENTODE

Miniature type used for vertical-deflection amplifier service in color and black-and-white television receivers. Outlines section, 6G; requires miniature 9-contact socket. Types 8CW5/XL86, 10CW5/LL86, and 15CW5/PL84 are identical with type 6CW5/EL86 except for heater ratings.

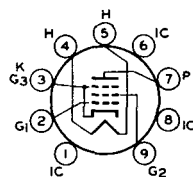

9CV

	6CW5/ EL86	8CW5/ XL86	10CW5/ LL86	15CW5/ PL84	
Heater Voltage (ac/dc)	6.3	8	10.6	15	volts
Heater Current	0.76	0.6	0.45	0.3	ampere
Heater Warm-up Time	—	—	11	—	seconds
Heater-Cathode Voltage:					
Peak value	± 330 max	± 330 max	± 330 max	± 330 max	volts
Average value	± 220 max	± 220 max	± 220 max	± 220 max	volts
Direct Interelectrode Capacitances:					
Grid No.1 to Plate				0.6	pF
Grid No.1 to Heater				0.25 max	pF
Grid No.1 to Cathode, Heater, Grid No.2, and Grid No.3				13	pF
Plate to Cathode, Heater, Grid No.2, and Grid No.3				6.8	pF

Class A₁ or Class AB₁ Amplifier

MAXIMUM RATINGS (Design-Maximum Values)

Plate Voltage	275	volts
Plate Supply Voltage	600	volts
Grid-No.2 Voltage	220	volts
Grid-No.2 (Screen-Grid) Supply Voltage	600	volts
Cathode Current	110	mA
Plate Dissipation	14	watts
Grid-No.2 Input	2.1	watts
Peak Grid-No.2 Input	7	watts

CHARACTERISTICS

Plate Voltage	170	volts
Grid-No.2 Voltage	170	volts
Grid-No.1 (Control-Grid) Voltage	-12.5	volts
Mu Factor (Grid No.2 to Grid No.1)	8	
Plate Resistance	26000	ohms
Transconductance	11000	umhos
Plate Current	70	mA
Grid-No.2 Current	3.5	mA

MAXIMUM CIRCUIT VALUE

Grid-No.1-Circuit Resistance	1	megohm
------------------------------------	---	--------

Vertical-Deflection Amplifier

For operation in a 525-line, 30-frame system

MAXIMUM RATINGS (Design-Maximum Values)

Plate Voltage	275	volts
Peak Positive-Pulse Plate Voltage#	2200	volts
Grid-No.2 Voltage	275	volts
Peak Negative-Pulse Grid-No.1 Voltage	250	volts
Peak Cathode Current	240	mA
Average Cathode Current	110	mA
Plate Dissipation	12	watts
Grid-No.2 Input	2.1	watts

MAXIMUM CIRCUIT VALUE

Grid-No.1-Circuit Resistance	2.2	megohms
------------------------------------	-----	---------

Pulse duration must not exceed 6% of a vertical scanning cycle (1.2 milliseconds).

**MEDIUM-MU TRIODE—
SHARP-CUTOFF PENTODE**

6CX8

8CX8

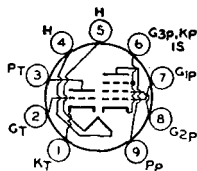

9DX

Miniature type used in television receiver applications. Pentode unit is used as video amplifier; triode unit is used in sound if-amplifier, sweep-oscillator, sync-separator, sync-amplifier, and sync-clipper circuits. Outlines section, 6E; requires miniature 9-contact socket. Type 8CX8 is identical with type 6CX8 except for heater ratings.

Heater Voltage (ac/dc)	6CX8 6.3	8CX8 8	volts
Heater Current	0.75	0.6	ampere
Heater Warm-up Time (Average)	—	11	volts
Heater-Cathode Voltage:			
Peak value	±200 max	±200 max	volts
Average value	100 max	100 max	volts
Direct Interelectrode Capacitances:			
Triode Unit:			
Grid to Plate		4.4	pF
Grid to Cathode and Heater		2.2	pF
Plate to Cathode and Heater		0.38	pF
Pentode Unit:			
Grid No.1 to Plate		0.06	pF
Grid No.1 to Cathode, Heater, Grid No.2, Grid No.3, and Internal Shield		9	pF
Plate to Cathode, Heater, Grid No.2, Grid No.3, and Internal Shield		4.4	pF
Triode Grid to Pentode Plate		0.018 max	pF
Pentode Grid No.1 to Triode Plate		0.005 max	pF
Pentode Plate to Triode Plate		0.17 max	pF

Class A₁ Amplifier

MAXIMUM RATINGS (Design-Maximum Values)

	Triode Unit	Pentode Unit	
Plate Voltage	330	330	volts
Grid-No.2 (Screen-Grid) Voltage	—	330	volts
Grid-No.2 Voltage	—	See curve page 300	
Grid-No.1 (Control-Grid) Voltage, Positive-bias value	0	0	volts
Plate Dissipation	2	5	watts
Grid-No.2 Input:			
For grid-No.2 voltages up to 165 volts	—	1.1	watts
For grid-No. voltages between 165 and 330 volts	—	See curve page 300	

CHARACTERISTICS

Plate Supply Voltage	150	200	volts
Grid-No.2 Supply Voltage	—	125	volts
Cathode-Bias Resistor	150	68	ohms
Amplification Factor	40	—	
Plate Resistance (Approx.)	8700	70000	ohms
Transconductance	4600	10000	μ mhos
Plate Current	9.2	24	mA
Grid-No.2 Current	—	5.2	mA
Grid-No.1 (Voltage Approx.) for plate current of 100 μ A	-5	-8.5	volts

MAXIMUM CIRCUIT VALUES

Grid-No.1-Circuit Resistance:			
For fixed-bias operation	0.5	0.25	megohm
For cathode-bias operation	1	1	megohm

6CY5

2CY5, 3CY5

SHARP-CUTOFF TETRODE

Miniature type used as rf amplifier in vhf tuners of television receivers. Outlines section, 5C; requires miniature 7-contact socket. Types 2CY5 and 3CY5 are identical with type 6CY5 except for heater ratings.

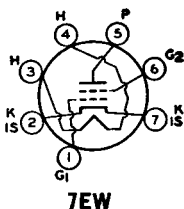

7EW

	2CY5	3CY5	6CY5	
Heater Voltage (ac/dc)	2.4	2.9	6.3	volts
Heater Current	0.6	0.45	0.2	ampere
Heater Warm-up Time (Average)	11	11	—	seconds
Peak Heater-Cathode Voltage	± 100 max	± 100 max	± 100 max	volts
Direct Interelectrode Capacitances (Approx.) [*] :				
Grid-No.1 to Plate			0.03	pF
Grid-No.1 to Cathode, Heater, Grid No.2 and Internal Shield			4.5	pF
Plate to Cathode, Heater, Grid No.2, and Internal Shield			3	pF

^{*} With external shield connected to cathode.

Class A₁ Amplifier

MAXIMUM RATINGS (Design-Maximum Values)

Plate Voltage	180	volts
Grid-No.2 (Screen-Grid) Supply Voltage	180	volts
Grid-No.2 Voltage	See curve page 300	
Grid-No.1 (Control-Grid) Voltage, Positive-bias value	0	volts
Cathode Current	20	mA
Plate Dissipation	2	watts
Grid-No.2 Input:		
For grid-No.2 voltages up to 90 volts	0.5	watt
For grid-No.2 voltages between 90 and 180 volts	See curve page 300	

CHARACTERISTICS

Plate Voltage	125	volts
Grid-No.2 Voltage	80	volts
Grid-No.1 Voltage	-1	volt
Plate Resistance (Approx.)	0.1	megohm
Transconductance	8000	μ mhos
Plate Current	10	mA
Grid-No.2 Current	1.5	mA
Grid-No.1 Voltage (Approx.) for plate current of 20 μ A	-6	volts

MAXIMUM CIRCUIT VALUE

Grid-No.1-Circuit Resistance	0.5	megohm
------------------------------	-----	--------

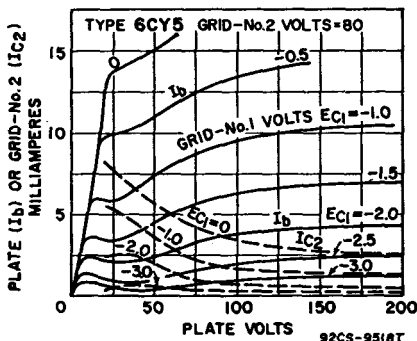

DUAL TRIODE

6CY7

Miniature type used as combined vertical oscillator and vertical-deflection amplifier in television receivers. Unit No.1 is used as a blocking oscillator in vertical-deflection circuits, and unit No.2 is used as a vertical-deflection amplifier. Outlines section, 6E; requires miniature 9-contact socket.

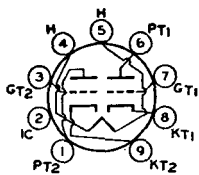

9LG

Heater Voltage (ac/dc)	6.3	volts
Heater Current	0.75	ampere
Heater-Cathode Voltage:		
Peak value	± 200 max	volts
Average value	100 max	volts

Class A₁ Amplifier

CHARACTERISTICS	Unit No.1	Unit No.2	
Plate Supply Voltage	250	150	volts
Grid Voltage	-3	—	volts
Cathode-Bias Resistor	—	620	ohms
Amplification Factor	68	5	
Plate Resistance (Approx.)	52000	920	ohms
Transconductance	1300	5400	μ mhos
Plate Current	1.2	30	mA
Plate Current for grid voltage of -30 volts	—	3.5	mA
Grid Voltage (Approx.) for plate current of 10 μ A	-5.5	—	volts
Grid Voltage (Approx.) for plate current of 200 μ A	—	-40	volts

Vertical-Deflection Oscillator and Amplifier

For operation in a 525-line, 30-frame system

MAXIMUM RATINGS (Design-Maximum Values)	Unit No.1 Oscillator	Unit No.2 Amplifier	
DC Plate Voltage	350	350	volts
Peak Positive-Pulse Plate Voltage†	—	1800	volts
Peak Negative-Pulse Grid Voltage	-400	-250	volts
Peak Cathode Current	—	120	mA
Average Cathode Current	—	35	mA
Plate Dissipation	1	5.5	watts

MAXIMUM CIRCUIT VALUES

Grid-Circuit Resistance	2.2	2.2†	megohms
-------------------------	-----	------	---------

† Pulse duration must not exceed 15% of a vertical scanning cycle (2.5 milliseconds).

† For cathode-bias operation.

6CZ5

5CZ5

BEAM POWER TUBE

Miniature type used as a vertical-deflection amplifier in high-efficiency deflection circuits of color and black-and-white television receivers and in the audio output stage of television and radio receivers. Outlines section, 6G; requires miniature 9-contact socket. Type 5CZ5 is identical with type 6CZ5 except for heater ratings.

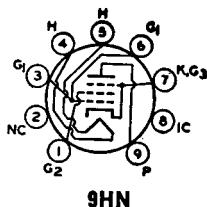

9HN

	5CZ5	6CZ5	
Heater Voltage (ac/dc)	4.7	6.3	volts
Heater Current	0.6	0.45	ampere
Heater Warm-up Time (Average)	11	11	seconds
Heater-Cathode Voltage:			
Peak value	±200 max	±200 max	volts
Average value	100 max	100 max	volts
Direct Interelectrode Capacitances:			
Grid No.1 to Plate		0.4 max	pF
Grid No.1 to Cathode, Heater, Grid No.2, and Grid No.3		9	pF
Plate to Cathode, Heater, Grid No.2, and Grid No.3		6	pF

Class A₁ Amplifier

CHARACTERISTICS

Plate Voltage	75	250	volts
Grid-No.2 Voltage	250	250	volts
Grid-No.1 Voltage	0	-15	volts
Plate Resistance	—	73000	ohms
Transconductance	—	4800	μmhos
Plate Current	130*	46	mA
Grid-No.2 Current	16*	4.6	mA
Grid-No.1 Voltage (Approx.) for plate current of 100 μA	—	-40	volts

Vertical-Deflection Amplifier

For operation in a 525-line, 30-frame system

MAXIMUM RATINGS (Design-Maximum Values)

DC Plate Voltage	350	volts
Peak Positive-Pulse Plate Voltage#	2200	volts
Grid-No.2 (Screen-Grid) Voltage	315	volts
Peak Negative-Pulse Grid-No.1 (Control-Grid) Voltage	275	volts
Peak Cathode Current	155	mA
Average Cathode Current	45	mA
Plate Dissipation	10	watts
Grid-No.2 Input	2.2	watts
Bulb Temperature (At hottest point)	250	°C

MAXIMUM CIRCUIT VALUES

Grid-No.1-Circuit Resistance:		
For fixed-bias operation	0.5	megohm
For cathode-bias operation	1	megohm

Pulse duration must not exceed 15% of a vertical scanning cycle (2.5 milliseconds).

* This value can be measured by a method involving a recurrent waveform such that the maximum ratings of the tube will not be exceeded.

6D4	Refer to chart at end of section.
6D6	Refer to chart at end of section.
6D7	Refer to chart at end of section.
6D8G	Refer to chart at end of section.
6D10	Refer to chart at end of section.
6DA4	Refer to chart at end of section. For replacement use type 6DM4A/6DA4.
6DB5	Refer to chart at end of section.

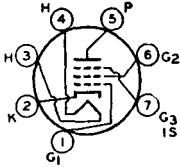

7CM

Heater Voltage (ac/dc)	6.3	volts
Heater Current	0.3	ampere
Heater-Cathode Voltage:		
Peak value	±200 max	volts
Average value	100 max	volts
Direct Interelectrode Capacitances:		
Grid No.1 to Plate	0.02 max	pF
Grid No.1 to Cathode, Heater, Grid No.2, Grid No.3, and Internal Shield	6.5	pF
Plate to Cathode, Heater, Grid No.2, Grid No.3, and Internal Shield	2	pF

SHARP-CUTOFF PENTODE

6DC6

Miniature type used in the gain-controlled picture if stages of color and black-and-white television receivers and as an rf amplifier in the tuners of such receivers. Outlines section, 5C; requires 7-contact miniature socket.

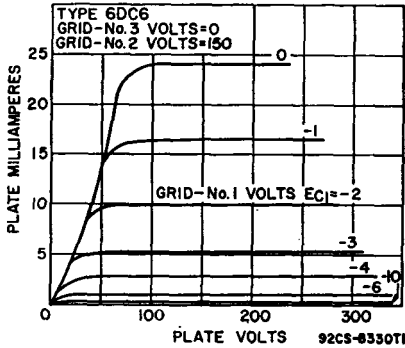

Class A₁ Amplifier

MAXIMUM RATINGS (Design-Center Values)

Plate Voltage	300	volts
Grid-No.3 (Suppressor-Grid) Voltage, Positive value	0	volts
Grid-No.2 Supply Voltage	300	volts
Grid-No.2 (Screen-Grid) Voltage	See curve page 300	
Grid-No.1 (Control-Grid) Voltage, Positive-bias value	0	volts
Plate Dissipation	2	watts
Grid-No.2 Input:		
For grid-No.2 voltages up to 150 volts	0.5	watt
For grid-No.2 voltages between 150 and 300 volts	See curve page 300	

CHARACTERISTICS

Plate Supply Voltage	200	volts
Grid No.3	Connected to cathode at socket	
Grid-No.2 Supply Voltage	150	volts
Cathode-Bias Resistor	180	ohms
Plate Resistance (Approx.)	0.5	megohm
Transconductance	5500	μmhos
Plate Current	9	mA
Grid-No.2 Current	3	mA
Grid-No.1 Voltage (Approx.) for transconductance of 50 μmhos ..	-12.5	volts

MAXIMUM CIRCUIT VALUES

Grid-No.1-Circuit Resistance:		
For fixed-bias operation	0.25	megohm
For cathode-bias operation	1	megohm

Refer to chart at end of section.

6DC8
6DC8/EBF89

Refer to chart at end of section.

6DE4

HALF-WAVE VACUUM RECTIFIER

6DE4/6CQ4

17DE4, 22DE4

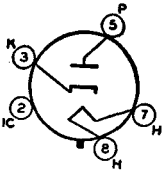

4CG

Glass octal type used as damper tube in horizontal-deflection circuits of television receivers. Outlines section, 13G; requires octal socket. Socket terminals 1, 2, 4, and 6 should not be used as tie points. This tube, like other power-handling tubes, should be adequately ventilated. Types 17DE4 and 22DE4 are identical with type 6DE4/6CQ4 except for heater ratings.

	6DE4/6CQ4	17DE4	22DE4	
Heater Voltage (ac/dc)	6.3	17	22.4	volts
Heater Current	1.6	0.6	0.45	amperes
Heater Warm-up Time (Average)	—	11	11	seconds
Direct Interelectrode Capacitances (Approx.):				
Plate to Cathode and Heater			8.5	pF
Cathode to Plate and Heater			11.5	pF
Heater to Cathode			4	pF

Damper Service

For operation in a 525-line, 30-frame system

MAXIMUM RATINGS (Design-Maximum Values)

Peak Inverse Plate Voltage#		5500	volts
Peak Plate Current		1100	mA
Average Plate Current		180	mA
Plate Dissipation		6.5	watts
Heater-Cathode Voltage:			
Peak value	+300	-5500	volts
Average value	+100	-900	volts

CHARACTERISTIC Instantaneous Value

Tube Voltage Drop for plate current of 350 mA	34	volts
-----------------------------------------------	----	-------

Pulse duration must not exceed 15% of a horizontal scanning cycle (10 microseconds).

6DE6

4DE6

SHARP-CUTOFF PENTODE

Miniature type used in the gain-controlled picture if stages of television receivers utilizing an intermediate frequency in the order of 40 MHz and as an rf amplifier in vhf television tuners. Outlines section, 5C; requires miniature 7-contact socket. Type 4DE6 is identical with type 6DE6 except for heater ratings.

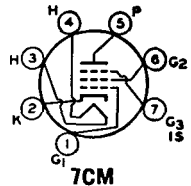

7CM

	4DE6	6DE6	
Heater Voltage (ac/dc)	4.2	6.3	volts
Heater Current	0.45	0.3	amperes
Heater Warm-up Time (Average)	11	—	seconds
Heater-Cathode Voltage:			
Peak value	±200 max	±200 max	volts
Average value	100 max	100 max	volts
Direct Interelectrode Capacitances:			
Grid No.1 to Plate	Unshielded	Shielded ^A	
Grid No.1 to Cathode, Heater, Grid No.2, Grid No.3, and Internal Shield	0.025 max	0.015 max	pF
Plate to Cathode, Heater, Grid No.2, Grid No.3, and Internal Shield	6.5	6.5	pF
	2	3	pF

^A With external shield connected to cathode.

Class A₁ Amplifier

MAXIMUM RATINGS (Design-Maximum Values)

Plate Voltage	330	volts
Grid-No.3 (Suppressor-Grid) Voltage, Positive value	0	volts
Grid-No.2 (Screen-Grid) Supply Voltage	330	volts
Grid-No.2 Voltage	See curve page 300	volts
Grid-No.1 (Control-Grid) Voltage, Positive-bias value	0	volts
Plate Dissipation	2.3	watts

Grid-No.2 Input:

For grid-No.2 voltages up to 165 volts	0.55	watt
For grid-No.2 voltages between 165 and 330 volts	See curve	page 300

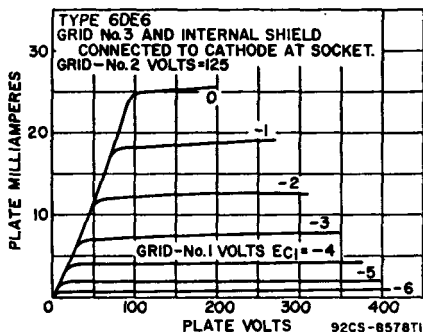

CHARACTERISTICS

Plate Supply Voltage	125	volts
Grid No.3	Connected to cathode at socket	
Grid-No.2 Supply Voltage	125	volts
Cathode-Bias Resistor	56	ohms
Plate Resistance (Approx.)	0.25	megohm
Transconductance	8000	μ mhos
Transconductance for grid-No.1 volts of -5.5 and cathode resistor of 0 ohms	700	μ mhos
Plate Current	15.5	mA
Grid-No.2 Current	4.2	mA
Grid-No.1 Voltage (Approx.) for plate current of 20 μ A	-9	volts

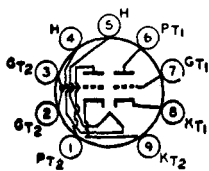

9HF

Miniature 9-contact socket. For curve of average plate characteristics, Unit No.2, refer to type 6DR7. Types 10DE7 and 13DE7 are identical with type 6DE7 except for heater ratings.

DUAL TRIODE

6DE7

10DE7, 13DE7

Miniature type used as combined vertical oscillator and vertical-deflection amplifier in television receivers. Unit No.1 is used as a blocking oscillator in vertical-deflection circuits, and unit No.2 is used as a vertical-deflection amplifier. Outlines section, 6E; requires miniature 9-contact socket.

Heater Voltage (ac/dc)	6.3	9.7	13	volts
Heater Current	0.9	0.6	0.45	ampere
Heater Warm-up Time (Average)	—	11	11	seconds
Heater-Cathode Voltage:				
Peak value	± 200 max	± 200 max	± 200 max	volts
Average value	100 max	100 max	100 max	volts
Direct Interelectrode Capacitances (Approx.):	Unit No.1	Unit No.2		
Grid to Plate	4	8.5		pF
Grid to Cathode and Heater	2.2	5.5		pF
Plate to Cathode and Heater	0.52	1		pF

Class A₁ Amplifier

CHARACTERISTICS

	Unit No.1	Unit No.2	
Plate Voltage	250	150	volts
Grid Voltage	-11	-17.5	volts
Amplification Factor	17.5	6	
Plate Resistance (Approx.)	8750	925	ohms
Transconductance	2000	6500	μ mhos
Plate Current	5.5	35	mA
Plate Current for grid voltage of -24 volts	—	10	mA
Grid Voltage (Approx.) for plate current of 10 μ A	-20	—	volts
Grid Voltage (Approx.) for plate current of 50 μ A	—	-44	volts

Plate Resistance (Approx.)	13000	28000	ohms
Transconductance	8000	8000	μ mhos
Load Resistance	2000	4000	ohms
Total Harmonic Distortion	10	10	per cent
Maximum-Signal Power Output	2.1	3.8	watts

MAXIMUM CIRCUIT VALUES

Grid-No.1-Circuit Resistance:			
For fixed-bias operation		0.1	megohm
For cathode-bias operation		0.5	megohm

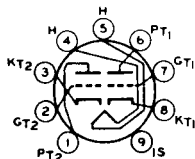

9AJ

MEDIUM-MU TWIN TRIODE

**6DJ8/
ECC88**
INDUSTRIAL
TYPE

Miniature type used as a cascode amplifier in vhf color and black-and-white television tuners. Outlines section, 6B; requires miniature 9-contact socket.

Heater Voltage (ac/dc)	6.3	volts
Heater Current	0.365	ampere

Heater-Cathode Voltage:	Unit No. 1	Unit No. 2	
Peak value	—	—150	volts
Average value	50	—130	volts
Direct Interelectrode Capacitances:			
Grid to Plate	1.4	1.4	pF
Grid to Cathode, Heater, and Internal Shield	3.3	—	pF
Cathode to Grid, Heater, and Internal Shield	—	6.0	pF
Plate to Cathode, Heater, and Internal Shield	1.8	—	pF
Plate to Grid, Heater, and Internal Shield	—	2.8	pF
Plate to Cathode	—	1.8	pF
Heater to Cathode	—	2.7	pF
Grid to Heater		0.13	pF
Plate of Unit No. 1 to Plate of Unit No. 2		0.045	pF
Grid of Unit No. 2 to Plate of Unit No. 1		0.005	pF

Class A₁ Amplifier (Each Unit)

MAXIMUM RATINGS (Design-Center Values)

Plate Supply Voltage	130	volts
Cathode Current	25	mA
Plate Dissipation	1.8	watts
Negative Grid Voltage	50	volts
Plate Supply Voltage (cold condition)	550	volts

CHARACTERISTICS

Plate Voltage	90	volts
Grid Voltage	—1.3	volts
Amplification Factor	33	
Transconductance	12250	μ mhos
Plate Current	15	mA
Equivalent Noise Resistance	300	ohms

MAXIMUM CIRCUIT VALUES

Grid-Circuit Resistance	1.0	megohm
Heater to Cathode Circuit Resistance	0.02	megohm

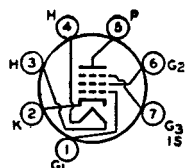

7CM

6DK6

3DK6, 4DK6, 12DK6

SHARP-CUTOFF PENTODE
Miniature type used as if-amplifier tube in color and black-and-white television receivers. Outlines section, 5C; requires miniature 7-contact socket. Types 3DK6, 4DK6, and 12DK6 are identical with type 6DK6 except for heater ratings.

	3DK6	4DK6	6DK6	12DK6	
Heater Voltage (ac/dc)	3.15	4.2	6.3	12.6	volts
Heater Current	0.6	0.45	0.3	0.15	ampere
Heater Warm-up Time (Average)	11	11	—	—	seconds
Heater-Cathode Voltage:					
Peak value	$\left\{ \begin{array}{l} +200 \text{ max} \\ -300 \text{ max} \\ 100 \text{ max} \end{array} \right.$				volts
Average value	100 max	100 max	100 max	100 max	volts
Direct Interelectrode Capacitances:					
Grid No.1 to Plate					0.025 max pF
Grid No.1 to Cathode, Heater, Grid No.2, Grid No.3 and Internal Shield					6.3 pF
Plate to Cathode, Heater, Grid No.2, Grid No.3, and Internal Shield					1.9 pF

Class A₁ Amplifier

MAXIMUM RATINGS (Design-Maximum Values)

Plate Voltage	330	volts
Grid-No.3 (Suppressor-Grid) Voltage, Positive value	0	volts
Grid-No.2 (Screen-Grid) Supply Voltage	330	volts
Grid-No.2 Voltage	See curve page 300	
Grid-No.1 (Control-Grid) Voltage, Positive-bias value	0	volts
Plate Dissipation	2.3	watts
Grid-No.2 Input:		
For grid-No.2 voltages up to 165 volts	0.55	watt
For grid-No.2 voltages between 165 and 330 volts	See curve page 300	

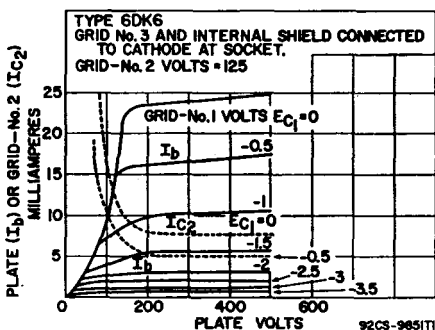

CHARACTERISTICS

Plate Supply Voltage	125	volts
Grid No.3	Connected to cathode at socket	
Grid-No.2 Supply Voltage	125	volts
Cathode-Bias Resistor	56	ohms
Plate Resistance (Approx.)	0.35	megohm
Transconductance	9800	μ mhos
Plate Current	12	mA
Grid-No.2 Current	3.8	mA
Grid-No.1 Voltage (Approx.) for plate current of 20 μ A	-6.5	volts

6DL3

25DL3

HALF-WAVE VACUUM RECTIFIER

Novar type used as a damper tube in television receivers. Outlines section, 40B; requires novar 9-contact socket. Socket terminals 1, 3, 6, 8, and 9 should not be used as tie points. Type 25DL3 is identical with type 6DL3 except for heater ratings.



	6DL3	25DL3	
Heater Voltage (ac/dc)	6.3	25.2	volts
Heater Current	2.3	0.45	amperes
Heater Warm-up Time (average)	—	11	seconds
Direct Interelectrode Capacitances:			
Cathode to Plate and Heater		17	pF
Plate to Cathode and Heater		13	pF
Heater to Cathode		4.4	pF

Damper Service

For operation in a 525-line, 30-frame system

Peak Inverse Plate Voltage#	6500	volts
Peak Plate Current	1800	mA
Average Plate Current	400	mA
Plate Dissipation	11	watts
Bulb Temperature (At hottest point)	220	°C
Heater-Cathode Voltage:		
Peak value	+300 —6500	volts
Average value	+100 —900	volts

CHARACTERISTIC, Instantaneous Value

Tube Voltage Drop for plate current of 800 mA	25	volts
-----------------------------------------------------	----	-------

Pulse duration must not exceed 15% of a horizontal scanning cycle.

Refer to chart at end of section.

6DL4/EC88

Refer to chart at end of section.

**6DL5
6DL5/EL95**

Refer to chart at end of section.

For replacement use type 6DM4A/6DA4.

**6DM4
6DM4A**

**6DM4A/
6DA4
17DM4A**

**HALF-WAVE
VACUUM RECTIFIER**

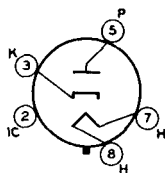

4CG

Glass octal type used as damper tube in horizontal-deflection circuits of television receivers. Outlines section, 13G; requires octal socket. Socket terminals 1, 2, 4, and 6 should not be used as tie points. This tube, like other power-handling tubes, should be adequately ventilated. Type 17DM4A is identical with type 6DM4A/6DA4 except for heater ratings.

	6DM4A/6DA4	17DM4A	
Heater Voltage (ac/dc)	6.3	16.8	volts
Heater Current	1.2	0.45	amperes
Heater Warm-up Time (Average)	—	11	seconds

Damper Service

For operation in a 525-line, 30-frame system

MAXIMUM RATINGS (Design-Maximum Values)

Peak Inverse Plate Voltage#	5000	volts
Peak Plate Current	1200	mA
Average Plate Current	200	mA
Plate Dissipation	6.5	watts
Heater-Cathode Voltage:		
Peak value	+300 —5000	volts
Average value	+100 —900	volts

Pulse duration must not exceed 15% of a horizontal scanning cycle (10 microseconds).

6DN3**HALF-WAVE
VACUUM RECTIFIER**

Novar type used as a damper diode in horizontal-deflection circuits of color television receivers. **Outlines section, 8G;** requires novar 9-contact socket. Terminals 1, 3, 6, and 8 should not be used as tie points for external-circuit components.

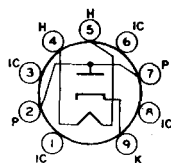
**9HP**

Heater Voltage (ac/dc)	6.3	volts
Heater Current	2.4	amperes
Direct Interelectrode Capacitances:		
Plate to Cathode and Heater	13	pF
Cathode to Plate and Heater	16	pF
Heater to Cathode	4	pF

Damper Service

For operation in a 525-line, 30-frame system

MAXIMUM RATINGS (Design-Maximum Values)

Peak Inverse Plate Voltage#	5500	volts	
Peak Plate Current	2100	mA	
Average Plate Current	350	mA	
Plate Dissipation	9	watts	
Bulb Temperature (At hottest point)	220	°C	
Heater-Cathode Voltage:			
Peak value	+300	—5500	volts
Average value	+100	—900	volts

CHARACTERISTIC, Instantaneous Value

Tube Voltage Drop for plate current of 350 mA	14	volts
-----------------------------------------------------	----	-------

Pulse duration must not exceed 15% of a horizontal scanning cycle (10 microseconds).

6DN6

Refer to chart at end of section.

6DN7**MEDIUM-MU DUAL TRIODE**

Glass octal type used as combined vertical-deflection-oscillator and vertical-deflection-amplifier tube in television receivers. **Outlines section, 13B;** requires octal socket. Heater: volts (ac/dc), 6.3; amperes, 0.9; maximum heater-cathode volts, ± 200 peak, 100 average.

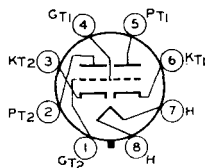
**8BD****Class A₁ Amplifier**

CHARACTERISTICS	Unit No.1	Unit No.2	
Plate Voltage	250	250	volts
Grid Voltage	—8	—9.5	volts
Amplification Factor	22.5	15.4	
Plate Resistance (Approx.)	9000	2000	ohms
Transconductance	2500	7700	μ mhos
Plate Current	8	41	mA
Grid Voltage (Approx.) for plate current of 10 μ A ..	—18	—	volts
Grid Voltage (Approx.) for plate current of 50 μ A ..	—	—23	volts

Vertical-Deflection Oscillator and Amplifier

For operation in a 525-line, 30-frame system

MAXIMUM RATINGS (Design-Maximum Values)	Unit No.1 Oscillator	Unit No.2 Amplifier	
DC Plate Voltage	350	550	volts
Peak Positive-Pulse Plate Voltage#	—	2500	volts
Peak Negative-Pulse Grid Voltage	400	250	mA
Peak Cathode Current	—	150	mA
Average Cathode Current	—	50	mA
Plate Dissipation	1	10	watts

MAXIMUM CIRCUIT VALUES

Grid-Circuit Resistance:			
For fixed-bias operation	2.2	2.2	megohms
For cathode-bias operation	2.2	—	megohms

Pulse duration must not exceed 15% of a vertical scanning cycle (2.5 milliseconds).

Refer to chart at end of section.
For replacement use type 6CG3/6BW3/6DQ3.

6DQ3

Refer to chart at end of section.

6DQ4

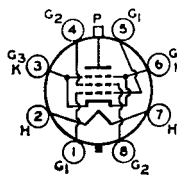

8JC

BEAM POWER TUBE

6DQ5

Glass octal type used as horizontal-deflection amplifier in color and black-and-white television receivers. Outlines section, 21B; requires octal socket.

Heater Voltage (ac/dc)	6.3	volts
Heater Current	2.5	amperes
Heater-Cathode Voltage:		
Peak value	±200 max	volts
Average value	100 max	volts
Direct Interelectrode Capacitances (Approx.):		
Grid No.1 to Plate	0.5	pF
Grid No.1 to Cathode, Heater, Grid No.2, and Grid No.3	23	pF
Plate to Cathode, Heater, Grid No.2, and Grid No.3	11	pF

Class A₁ Amplifier

CHARACTERISTICS

	Pentode Connection		Triode* Connection	
Plate Voltage	70	175	125	volts
Grid No.2 (Screen-Grid) Voltage	125	125	—	volts
Grid No.1 (Control-Grid) Voltage	0	-25	-25	volts
Amplification Factor	—	—	3.3	
Plate Resistance (Approx.)	—	5500	—	ohms
Transconductance	—	10500	—	μmhos
Plate Current	550*	110	—	mA
Grid-No.2 Current	42*	5	—	mA
Grid-No.1 Voltage (Approx.) for plate mA = 1	—	-55	—	volts

* Grid No.2 connected to plate.

* This value can be measured by a method involving a recurrent waveform such that the maximum ratings of the tube will not be exceeded.

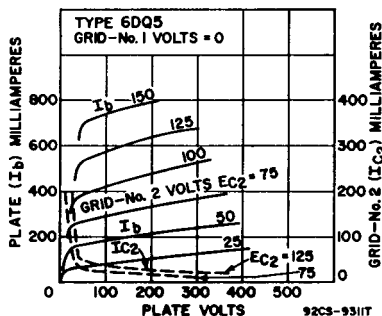
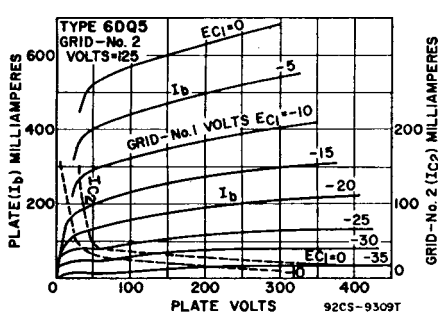

Horizontal-Deflection Amplifier

For operation in a 525-line, 30-frame system

MAXIMUM RATINGS (Design-Maximum Values)

DC Plate Voltage	990	volts
Peak Positive-Pulse Plate Voltage#	6500	volts
Peak Negative-Pulse Plate Voltage	1100	volts
DC Grid-No.2 (Screen-Grid) Voltage	190	volts
Peak Negative-Pulse Grid-No.1 (Control-Grid) Voltage	250	volts
Peak Cathode Current	1100	mA
Average Cathode Current	315	mA
Grid-No.2 Input	3.2	watts
Plate Dissipation*	24	watts
Bulb Temperature (At hottest point)	220	°C

MAXIMUM CIRCUIT VALUE

Grid-No.1-Circuit Resistance, for grid-resistor-bias operation 0.47 megohm
 # Pulse duration must not exceed 15% of a horizontal scanning cycle (10 microseconds).
 * A bias resistor or other means is required to protect the tube in absence of excitation.

6DQ6A

Refer to chart at end of section.

6DQ6B

For replacement use type 6GW6/6DQ6B.

6DR7

10DR7, 13DR7

DUAL TRIODE

Miniature type containing high-mu and low-mu triodes; used as combined vertical-deflection-oscillator and vertical-deflection-amplifier tube in television receivers. **Outlines section, 6E**; requires miniature 9-contact socket. Types 10DR7 and 13DR7 are identical with type 6DR7 except for heater ratings.

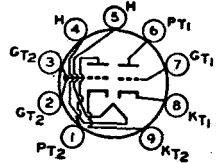

9HF

	6DR7	10DR7	13DR7	
Heater Voltage (ac/dc)	6.3	9.7	13	volts
Heater Current	0.9	0.6	0.45	ampere
Heater Warm-up Time (Average)	—	11	11	seconds
Heater-Cathode Voltage:				
Peak value	±200 max	±200 max	±200 max	volts
Average value	100 max	100 max	100 max	volts
Direct Interelectrode Capacitances (Approx.):				
	Unit No.1	Unit No.2		
Grid to Plate	4.5	8.5		pF
Grid to Cathode and Heater	2.2	5.5		pF
Plate to Cathode and Heater	0.34	1		pF

Class A₁ Amplifier

CHARACTERISTICS

	Unit No.1	Unit No.2	
Plate Voltage	250	150	volts
Grid Voltage	—3	—17.5	volts
Amplification Factor	68	6	
Plate Resistance (Approx.)	40000	925	ohms
Transconductance	1600	6500	μmhos
Plate Current	1.4	35	mA
Plate Current for grid voltage of —24 volts	—	10	mA
Grid Voltage (Approx.) for plate current of 10 μA	—5.5	—	volts
Grid Voltage (Approx.) for plate current of 50 μA	—	—44	volts

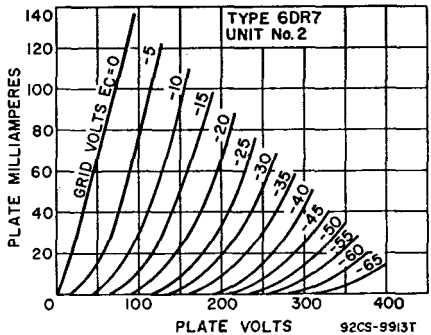
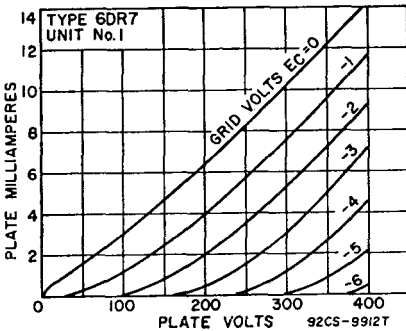

Vertical-Deflection Oscillator and Amplifier

For operation in a 525-line, 30-frame system

MAXIMUM RATINGS (Design-Maximum Values)

	Unit No.1	Unit No.2	
DC Plate Voltage	330	275	volts
Peak Positive-Pulse Plate Voltage#	—	1500	volts

Peak Negative-Pulse Grid Voltage	400	250	volts
Peak Cathode Current	70	175	mA
Average Cathode Current	20	50	mA
Plate Dissipation	1	7	watts

MAXIMUM CIRCUIT VALUES

Grid-Circuit Resistance:
 For grid-resistance-bias or cathode-bias operation 2.2 2.2 megohms
 # Pulse duration must not exceed 15% of a vertical scanning cycle (2.5 milliseconds).

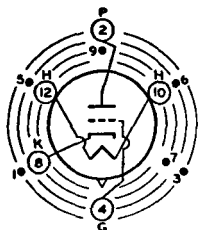

INDEX=LARGE LUG
 ●=PIN CUT OFF

12AQ

HIGH-MU TRIODE

6DS4

2DS4

Nuvistor type used as grounded-cathode, neutralized rf amplifier in vhf tuners of color and black-and-white television and FM receivers. Outlines section, 1; requires nuvistor socket. Type 2DS4 is identical with type 6DS4 except for heater ratings.

	2DS4	6DS4	
Heater Voltage (ac/dc)	2.1	6.3	volts
Heater Current	0.45	0.135	ampere
Heater Warm-up Time (Average)	8	—	seconds
Peak Heater-Cathode Voltage	±100 max	±100 max	volts
Direct Interelectrode Capacitances (Approx.)			
Grid to Plate		0.92	pF
Grid to Cathode, Heater, and Shell		4.3	pF
Plate to Cathode, Heater, and Shell		1.8	pF
Plate to Cathode		0.18	pF
Heater to Cathode		1.6	pF

Class A₁ Amplifier

MAXIMUM RATINGS (Design-Maximum Values)

Plate Supply Voltage	300°	volts
Plate Voltage	135	volts
Grid Voltage, Negative-bias value	55	volts
Grid Voltage, Peak positive value	0	volts
Cathode Current	15	mA
Plate Dissipation	1.5	watt

CHARACTERISTICS

Plate Supply Voltage	110	volts
Grid Supply Voltage	0	volts
Cathode-Bias Resistor	130	ohms
Amplification Factor	63	
Plate Resistance (Approx.)	7000	ohms
Transconductance	9000	μmhos
Plate Current	6.5	mA
Grid Voltage (Approx.) for plate current of 100 μA	-5	volts
Grid Voltage (Approx.) for plate current of 10 μA	-6.8	volts

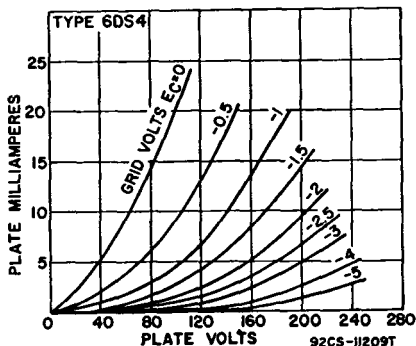

TYPICAL OPERATION

Plate Voltage	70	volts
Grid Supply Voltage	0	volts
Grid Resistor	47000	ohms
Amplification Factor	68	
Plate Resistance (Approx.)	5440	ohms
Transconductance	12500	μ hos
Plate Current	7	mA

MAXIMUM CIRCUIT VALUES

Grid-Circuit Resistance:		
For fixed-bias operation	0.5	megohm
For cathode-bias operation	2.2	megohm

* A plate supply voltage of 300 volts may be used provided a sufficiently large resistor is used in the plate circuit to limit the plate dissipation to 1.5 watts under any condition of operation.

* For operation at metal-shell temperatures up to 125°C.

6DS5

11DS5

BEAM POWER TUBE

Miniature type used in the audio output stages of television and radio receivers. Outlines section, 5D; requires miniature 7-contact socket. Type 11DS5 is identical with type 6DS5 except for heater ratings.

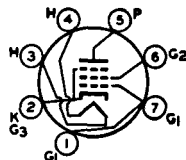

7BZ

Heater Voltage (ac/dc)	6DS5	11DS5	
Heater Current	6.3	11.2	volts
Heater Warm-up Time	0.8	0.45	ampere
Peak Heater-Cathode Voltage	±200 max	±200 max	seconds
Direct Interelectrode Capacitances (Approx.):			volts
Grid No.1 to Plate		0.19	pF
Grid No.1 to Cathode, Heater, Grid No.2, and Grid No.3		9.5	pF
Plate to Cathode, Heater, Grid No.2, and Grid No.3		6.3	pF

Class A₁ Amplifier

MAXIMUM RATINGS (Design-Maximum Values)

Plate Voltage	275	volts
Grid-No.2 (Screen-Grid) Voltage	275	volts
Grid-No.1 (Control-Grid) Voltage, Positive-bias value	0	volts
Plate Dissipation	9	watts
Grid-No.2 Input	2.2	watts
Bulb Temperature (At hottest point)	250	°C

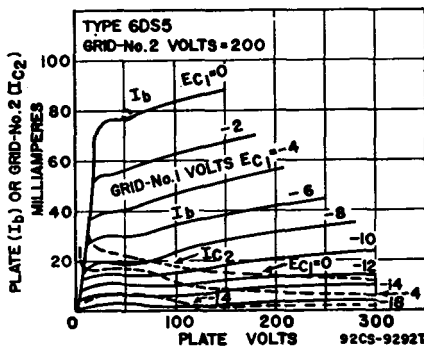

TYPICAL OPERATION AND CHARACTERISTICS

	Cathode-Bias Operation		Fixed-Bias Operation		
Plate Supply Voltage	200	250	200	250	volts
Grid-No.2 Supply Voltage	200	200	200	200	volts
Grid-No.1 Voltage	—	—	-7.5	-8.5	
Cathode-Bias Resistor	180	270	—	—	ohms

Peak AF Grid-No.1 Voltage	7.5	9.2	7.5	8.5	volts
Zero-Signal Plate Current	34.5	27	35	29	mA
Maximum-Signal Plate Current	32.5	25	36	32	mA
Zero-Signal Grid-No.2 Current	3.5	3	3	3	mA
Maximum-Signal Grid-No.2 Current	9	9	9	10	mA
Plate Resistance (Approx.)	28000	28000	28000	28000	ohms
Transconductance	6000	5800	6000	5800	μmhos
Load Resistance	6000	8000	6000	8000	ohms
Total Harmonic Distortion	10	10	9	10	per cent
Maximum-Signal Power Output	2.8	3.6	3	3.8	watts

MAXIMUM CIRCUIT VALUES

Grid-No.1-Circuit Resistance:		
For fixed-bias operation	0.1	megohm
For cathode-bias operation	1	megohm

Refer to chart at end of section.
For replacement use type 6CE3/6CD3/6DT3.

6DT3

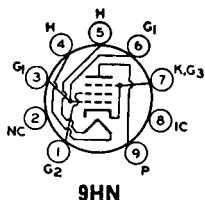

BEAM POWER TUBE

6DT5
12DT5

Miniature type used as a vertical-deflection-amplifier tube in television receivers employing 110-degree picture-tube systems. Outlines section, 6E; requires miniature 9-contact socket. Type 12DT5 is identical with type 6DT5 except for heater ratings.

Heater Voltage (ac/dc)	6.3	12.6	volts
Heater Current	1.2	0.6	amperes
Heater Warm-up Time (Average)	—	11	seconds
Heater-Cathode Voltage:			
Peak value	±200 max	±200 max	volts
Average value	100 max	100 max	volts

Class A₁ Amplifier

CHARACTERISTICS

Plate Voltage	60	80	250	volts
Grid-No. 2 Voltage	150	250	250	volts
Grid-No.1 Voltage	0	0	-16.5	volts
Transconductance	—	—	6200	μmhos
Plate Current	95*	195*	44	mA
Grid-No.2 Current	8.5*	19*	1.5	mA
Grid-No.1 Voltage (Approx.) for plate current of 100 mA	—	—	-35	volts

* These values can be measured by a method involving a recurrent waveform such that the maximum ratings of the tube will not be exceeded.

Vertical-Deflection Amplifier

For operation in a 525-line, 30-frame system

MAXIMUM RATINGS (Design-Maximum Values)

DC Plate Voltage	315	volts
Peak Positive-Pulse Plate Voltage#	2200	volts
Grid-No.2 (Screen-Grid) Voltage	285	volts
Peak Negative-Pulse Grid-No.1 (Control-Grid) Voltage	250	volts
Peak Cathode Current	190	mA
Average Cathode Current	55	mA
Plate Dissipation	9	watts
Grid-No.2 Input	2	watts

MAXIMUM CIRCUIT VALUES

Grid-No.1-Circuit Resistance:		
For fixed-bias operation	0.5	megohm
For cathode-bias operation	1	megohm

Pulse duration must not exceed 15% of a vertical scanning cycle (2.5 milliseconds).

Refer to chart at end of section.

6DT6

6DT6A

3DT6A, 4DT6A

SHARP-CUTOFF PENTODE

Miniature type used as FM detector in color and black-and-white television receivers. Outlines section, 5C; requires miniature 7-contact socket. Types 3DT6A and 4DT6A are identical with type 6DT6A except for heater ratings.

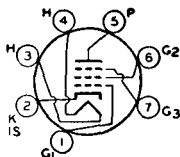
**7EN**

	3DT6A	4DT6A	6DT6A	
Heater Voltage (ac/dc)	3.15	4.2	6.3	volts
Heater Current	0.6	0.45	0.3	ampere
Heater Warm-up Time (Average)	11	11	—	seconds
Heater-Cathode Voltage:				
Peak value	±200 max	±200 max	±200 max	volts
Average value	100 max	100 max	100 max	volts
Direct Interelectrode Capacitances (Approx.)*				
Grid No.1 to Plate			0.02	pF
Grid No.1 to Cathode, Heater, Grid No.2, Grid No.3, and Internal Shield			5.8	pF
Grid No.3 to Plate			1.7	pF
Grid No.1 to Grid No.3			0.1	pF
Grid No.3 to Cathode, Heater, Grid No.1, Grid No.2, and Internal Shield			6.1	pF

* External shield connected to cathode.

Class A₁ Amplifier**CHARACTERISTICS**

Plate Supply Voltage	150	volts
Grid No.3 (Suppressor Grid)	Connected to cathode at socket	
Grid-No.2 (Screen-Grid) Supply Voltage	100	volts
Cathode-Bias Resistor	560	ohms
Plate Resistance (Approx.)	0.15	megohm
Transconductance, Grid No.1 to Plate	1350	μmhos
Transconductance, Grid No.3 to Plate	515	μmhos
Plate Current	1.55	mA
Grid-No.2 Current	1.8	mA
Grid-No.1 Voltage (Approx.) for plate current of 10 μA	—5.2	volts
Grid-No.3 Voltage (Approx.) for plate current of 10 μA	—4.2	volts

FM Detector**MAXIMUM RATINGS (Design-Maximum Values)**

Plate Voltage	330	volts
Grid-No.3 Voltage	28	volts
Grid-No.2 Supply Voltage	330	volts
Grid-No.2 Voltage	See curve page 300	
Grid-No.1 (Control-Grid) Voltage, Positive-bias value	0	volts
Plate Dissipation	1.7	watts
Grid-No.2 Input:		
For grid-No.2 voltages up to 165 volts	1.1	watts
For grid-No.2 voltages between 165 and 330 volts	See curve page 300	

MAXIMUM CIRCUIT VALUES

Grid-No.1-Circuit Resistance:		
For fixed-bias operation	0.25	megohm
For cathode-bias operation	0.5	megohm

6DT8

12DT8

HIGH-MU TWIN TRIODE

Miniature type used in radio and television receiver applications and in push-pull rf amplifiers or as frequency converter in FM tuners. Outlines section, 6B; requires miniature 9-contact socket. Type 12DT8 is identical with type 6DT8 except for the heater ratings. Except for heater and heater-cathode ratings, interelectrode capacitances, and basing arrangement, these types are identical with miniature type 12AT7.

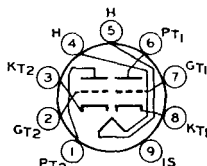
**9AJ**

	6DT8	12DT8	
Heater Voltage (ac/dc)	6.3	12.6	volts
Heater Current	0.3	0.15	ampere
Heater-Cathode Voltage:			
Peak value	±200 max	±200 max	volts
Average value	100 max	100 max	volts
Direct Interelectrode Capacitances (Approx., Each Unit Except as Noted:			
Grid to Plate		1.6*	pF
Grid to Cathode, Heater, and Internal Shield		2.7*	pF
Plate to Cathode, Heater, and Internal Shield		1.6*	pF
Heater to Cathode		3*	pF
Cathode to Grid, Heater, and Internal Shield (Unit No.2)		5.3†	pF
Plate to Grid, Heater, and Internal Shield (Unit No.2)		2.8†	pF

- † With external shield connected to grid of unit under test.
- With external shield connected to ground.
- With external shield connected to cathode of unit under test.

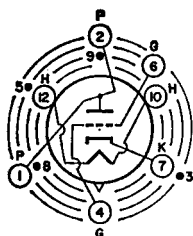

INDEX = LARGE LUG
 • = SHORT PIN

12EA

MEDIUM-MU TRIODE

6DV4

2DV4

Nuvistor type used at frequencies up to 1000 MHz in uhf oscillator stages of color and black-and-white television receivers. Outlines section, 1; requires nuvistor socket. Type 2DV4 is identical with type 6DV4 except for heater ratings.

	2DV4	6DV4	
Heater Voltage (ac/dc)	2.1	6.3	volts
Heater Current	0.45	0.135	ampere
Heater Warm-up Time (Average)	8	—	seconds
Peak Heater-Cathode Voltage	±100 max	±100 max	volts
Direct Interelectrode Capacitance (Approx.):			
Grid to Plate		1.8	pF
Grid to Cathode, Heater, and Shell		4.4	pF
Plate to Cathode, Heater, and Shell		1.9	pF
Plate to Cathode		0.25	pF
Heater to Cathode		1.4	pF
Grid to Cathode		3.7	pF

Class A₁ Amplifier

MAXIMUM RATINGS (Design-Maximum Values)

Plate Supply Voltage	300	volts
Plate Voltage	125	volts
Grid Voltage:		
Negative-bias value	55	volts
Peak positive value	2	volts
Plate Dissipation	1	watt
Cathode Current	15	mA

CHARACTERISTICS

Plate Supply Voltage	75	volts
Cathode-Bias Resistor	100	ohms
Amplification Factor	35	
Plate Resistance (Approx.)	3100	ohms
Transconductance	11500	μmhos
Plate Current	10.5	mA
Grid Voltage (Approx.) for plate current of 10 μA	-7	volts

TYPICAL OPERATION AS OSCILLATOR AT 950 MHz

Plate Voltage	60	volts
Grid Voltage	-2	volts
Grid Resistor	5600	ohms
Plate Current	8	mA
Grid Current	350	μA

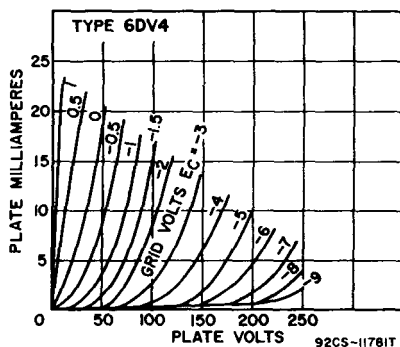
**MAXIMUM CIRCUIT VALUES**

Grid-Circuit Resistance:*

For fixed-bias operation	0.1	megohm
For cathode-bias operation	0.2	megohm

* For operation at metal-shell temperatures up to 135°C.

6DW4
6DW4A

Refer to chart at end of section.

6DW4B

HALF-WAVE
VACUUM RECTIFIER

Novar types used as damper tubes in horizontal-deflection circuits of color and black-and-white television receivers. **Outlines section, 11D and 30B**, respectively; require novar 9-contact socket. Socket terminals 1, 3, 6, and 8 should not be used as tie points; it is recommended that socket clips for these pins be removed to reduce the possibility of arc-over and to minimize leakage. These tubes, like other power-handling tubes, should be adequately ventilated.

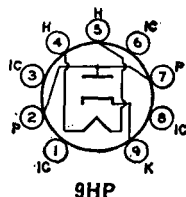
**9HP**

Heater Voltage (ac/dc)	6.3	volts
Heater Current	1.2	amperes
Direct Interelectrode Capacitances (Approx.):		
Plate to Cathode and Heater	6.5	pF
Cathode to Plate and Heater	9	pF
Heater to Cathode	2.8	pF

Damper Service

For operation in a 525-line, 30-frame system

MAXIMUM RATINGS (Design-Maximum Values)

Peak Inverse Plate Voltage#	5500	volts
Peak Plate Current	1300	mA
Average Plate Current	250	mA
Plate Dissipation	8.5	watts
Heater-Cathode Voltage:		
Peak value	+300 —5000	volts
Average value	+100 —900	volts

CHARACTERISTIC, Instantaneous Value

Tube Voltage Drop for plate current of 350 mA	25	volts
-----------------------------------------------------	----	-------

Pulse duration must not exceed 15% of a horizontal scanning cycle (10 microseconds).

6DW5

Refer to chart at end of section.

6DX8

Refer to chart at end of section.

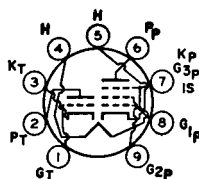

9HX

**HIGH-MU TRIODE—
SHARP-CUTOFF PENTODE**

**6DX8/
ECL84**

10DX8/LCL84

Miniature type used in color and black-and-white television-receiver applications. The triode unit is used as a sync-separator, sync-amplifier, keyed-agc, or noise-suppressor tube. The pentode unit is used as a video-output tube. **Outlines section, 6E**; requires miniature 9-contact socket. Type 10DX8/LCL84 is identical with type 6DX8/ECL84 except for heater ratings.

	6DX8/ECL84	10DX8/LCL84	
Heater Voltage (ac/dc)	6.3	10.2	volts
Heater Current	0.72	0.45	ampere
Peak Heater-Cathode Voltage	±200 max	±200 max	volts

Class A₁ Amplifier

MAXIMUM RATINGS (Design-Center Values)

Triode Unit Pentode Unit

Plate Supply Voltage	550	550	volts
Peak Plate Voltage, with maximum plate current of 0.1 mA	600	—	volts
Plate Voltage	300	300	volts
Grid-No.2 (Screen-Grid) Supply Voltage	—	550	volts
Grid-No.2 Voltage	—	300	volts
Cathode Current	12	40	mA
Plate Dissipation	1	4	watts
Grid-No.2 Input	—	1.7	watts

CHARACTERISTICS

Triode Unit

Pentode Unit

Plate Voltage	200	170	200	220	volts
Grid-No.2 Voltage	—	170	200	220	volts
Grid No.1 Voltage	-1.7	-2.1	-2.9	-3.4	volts
Amplification Factor	65	—	—	—	
Mu-Factor, Grid-No.2 to Grid-No.1	—	36	36	36	
Plate Resistance (Approx.)	—	0.1	0.13	0.15	megohm
Transconductance	4000	11000	10400	10000	μmhos
Plate Current	3	18	18	18	mA
Grid-No.2 Current	—	3	3	3	mA

MAXIMUM CIRCUIT VALUES

Triode Unit Pentode Unit

Grid-No.1- Circuit Resistance:			
For fixed-bias operation	1	1	megohm
For cathode-bias operation	3	2	megohms

• With maximum duty factor of 0.18 and maximum pulse duration of 18 microseconds.

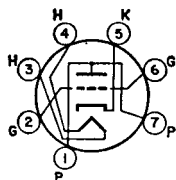

7DK

MEDIUM-MU TRIODE

6DZ4

Miniature type used as a local-oscillator tube in uhf color and black-and-white television receivers covering the frequency range from 470 to 890 MHz. **Outlines section, 5B**; requires miniature 7-contact socket. For curve of average plate characteristics, refer to type 6AF4A.

Heater Voltage (ac/dc)	6.3	volts
Heater Current	0.225	ampere
Heater-Cathode Voltage:		
Peak value	±50 max	volts
Average value	25 max	volts
Direct Interelectrode Capacitances (Approx.):*		
Grid to Plate	1.8	pF
Grid to Cathode and Heater	2.2	pF
Plate to Cathode and Heater	1.3	pF

* With external shield connected to cathode.

Class A₁ Amplifier

CHARACTERISTICS

Plate Supply Voltage	80	volts
Plate Resistor	2700	ohms
Amplification Factor	14	
Plate Resistance (Approx.)	2000	ohms
Transconductance	6700	μ mhos
Plate Current	15	mA
Grid Voltage (Approx.) for plate current of 20 μ A	-11	volts

UHF Oscillator

MAXIMUM RATINGS (Design-Maximum Values)

Plate Voltage	135	volts
Grid Voltage, Negative-bias value	50	volts
Grid Current	2	mA
Cathode Current	20	mA
Plate Dissipation	2.3	watts

TYPICAL OPERATION AS OSCILLATOR AT 1000 MHz

Plate Supply Voltage	135	volts
Plate-Circuit Resistance	2700	ohms
Grid Resistor	10000	ohms
Grid Current	15.5	mA
Grid Current (Approx.)	800	μ A

MAXIMUM CIRCUIT VALUES

Grid-Circuit Resistance:		
For fixed-bias operation		Not recommended
For cathode-bias operation	0.5	megohm

6DZ7

Refer to chart at end of section.

6E5

ELECTRON-RAY TUBE

Glass type used to indicate the effects of a change in a controlling voltage. It is used to indicate accurate radio-receiver tuning. Outlines section, 13H; requires 6-contact socket. Heater: volts (ac/dc), 6.3; amperes, 0.3. For additional considerations, refer to Tuning Indication with Electron-Ray Tubes in Electron Tube Applications section.

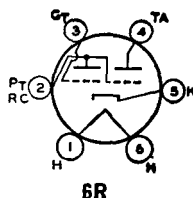

Tuning Indicator

MAXIMUM AND MINIMUM RATINGS (Design-Center Values)

Plate-Supply Voltage	250 max	volts
Target Voltage	{ 250 max	volts
	{ 125 min	volts

TYPICAL OPERATION

Plate and Target Supply Voltage	200	250	volts
Series Triode-Plate Resistor	1	1	megohm
Target Current*†	3	4	mA
Triode-Plate Current*	0.19	0.24	mA
Triode-Grid Voltage (Approx.):			
For shadow angle of 0°	-6.5	-8	volts
For shadow angle of 90°	0	0	volts

* For zero triode-grid voltage.

† Subject to wide variations.

6E6

Refer to chart at end of section.

6E7

Refer to chart at end of section.

6EA4

Refer to chart at end of section.

6EA5

Refer to chart at end of section.
For replacement use type 6CY5.

Refer to chart at end of section.
For replacement use type 6EM7/6EA7.

6EA7

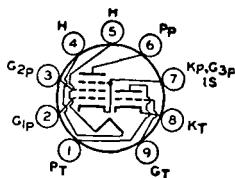

9AE

**MEDIUM-MU TRIODE—
SHARP-CUTOFF PENTODE**

6EA8

5EA8, 19EA8

Miniature type used as combined oscillator and mixer in color and black-and-white television receivers utilizing an intermediate frequency in the order of 40 MHz. Outlines section, 6B; requires miniature 9-contact socket. Types 5EA8 and 19EA8 are identical with type 6EA8 except for heater ratings.

	5EA8	6EA8	19EA8	
Heater Voltage (ac/dc)	4.7	6.3	18.9	volts
Heater Current	0.6	0.45	0.15	ampere
Heater Warm-up Time (Average)	11	11	11	seconds
Heater-Cathode Voltage:				
Peak value	±200 max	±200 max	±200 max	volts
Average value	100 max	100 max	100 max	volts

Unshielded Shielded

Direct Interelectrode Capacitances:

Triode Unit:	Unshielded	Shielded	
Grid to Plate	1.7	1.7	pF
Grid to Cathode, Heater, Pentode Cathode, Pentode Grid No.3, and Internal Shield	3	3.2	pF
Plate to Cathode, Heater, Pentode Cathode, Pentode Grid No.3, and Internal Shield	1.4	1.9	pF
Cathode to Heater	3	3*	pF
Pentode Unit:			
Grid No.1 to Plate	0.02 max	0.01 max	pF
Grid No.1 to Cathode, Heater, Grid No.2, Grid No.3, and Internal Shield	5	5	pF
Plate to Cathode, Heater, Grid No.2, Grid No.3, and Internal Shield	2.6	3.4	pF
Heater to Cathode	3	3*	pF

- * With external shield connected to cathode of unit under test except as noted.
- With external shield connected to ground.

Class A₁ Amplifier

MAXIMUM RATINGS (Design-Maximum Values)

Plate Voltage	330	330	volts
Grid-No.2 (Screen-Grid) Supply Voltage	—	330	volts
Grid-No.2 Voltage	—	See curve page 300	
Grid-No.1 (Control-Grid) Voltage, Positive-bias value	0	0	volts
Plate Dissipation	2.5	3.1	watts
Grid-No.2 Input:			
For grid-No.2 voltages up to 165 volts	—	0.55	watt
For grid-No.2 voltages between 165 and 330 volts	—	See curve page 300	

Triode Unit Pentode Unit

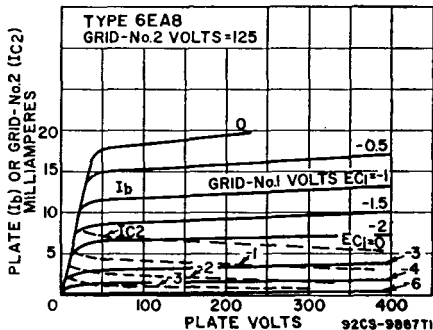
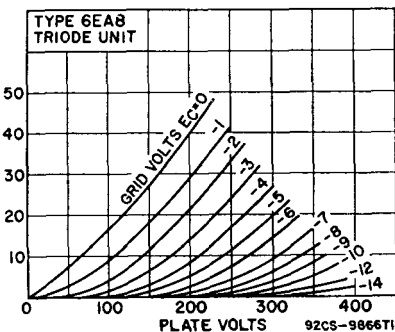

CHARACTERISTICS

Plate Supply Voltage	150	125	volts
Grid-No.2 Voltage	—	125	volts
Grid-No.1 Voltage	—	-1	volt
Cathode-Bias Resistor	56	—	ohms
Amplification Factor	40	—	
Plate Resistance (Approx.)	5000	200000	ohms
Transconductance	8500	6400	μmhos
Plate Current	18	12	mA
Grid-No.2 Current	—	4	mA
Grid-No.1 Voltage for plate current of 10 μA	-12	-9	volts

6EB8

**HIGH-MU TRIODE—
SHARP-CUTOFF PENTODE**

Miniature type used in color and black-and-white television receiver applications. Pentode unit is used as video output amplifier; triode unit is used in sync-separator, sync-clipper, and phase-inverter circuits. Outlines section, 6E; requires miniature 9-contact socket.

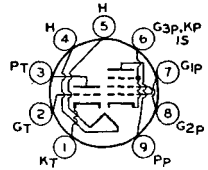

9DX

Heater Voltage (ac/dc)	6.3	volts
Heater Current	0.75	ampere
Heater-Cathode Voltage:		
Peak value	±200 max	volts
Average value	100 max	volts
Direct Interelectrode Capacitances:		
Triode Unit:		
Grid to Plate	4.4	pF
Grid to Cathode and Heater	2.4	pF
Plate to Cathode and Heater	0.36	pF
Pentode Unit:		
Grid No.1 to Plate	0.1 max	pF
Grid No.1 to Cathode, Heater, Grid No.2, Grid No.3, and Internal Shield	11	pF
Plate to Cathode, Heater, Grid No.2, Grid No.3, and Internal Shield	4.2	pF
Triode Grid to Pentode Plate	0.018 max	pF
Pentode Grid No.1 to Triode Plate	0.005 max	pF
Pentode Plate to Triode Plate	0.17 max	pF

Class A₁ Amplifier

MAXIMUM RATINGS (Design-Maximum Values)	Triode Unit	Pentode Unit	
Plate Voltage	330	330	volts
Grid-No.2 (Screen-Grid) Supply Voltage	—	330	volts
Grid-No.2 Voltage	—	See curve page 300	
Grid-No.1 (Control-Grid) Voltage, Positive-bias value	0	0	volts
Plate Dissipation	1	5	watts
Grid-No.2 Input:			
For grid-No.2 voltages up to 165 volts	—	1.1	watts
For grid-No.2 voltages between 165 and 330 volts	—	See curve page 300	

CHARACTERISTICS

Plate Supply Voltage	250	200	volts
Grid-No.2 Supply Voltage	—	125	volts
Grid Voltage	-2	—	volts
Cathode-Bias Resistor	—	68	ohms
Amplification Factor	100	—	
Plate Resistance (Approx.)	37000	75000	ohms
Transconductance	2700	12500	μmhos
Plate Current	2	25	mA
Grid-No.2 Current	—	7	mA
Grid Voltage (Approx.) for plate current of 20 μA	-5	—	volts
Grid-No.1 Voltage (Approx.) for plate current of 100 μA	—	-9	volts

MAXIMUM CIRCUIT VALUES

Grid-No.1-Circuit Resistance:			
For fixed-bias operation	0.5	0.25	megohm
For cathode-bias operation	1	1	megohm

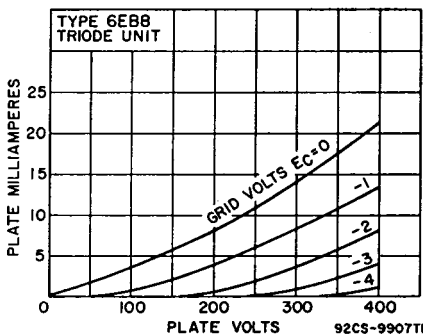
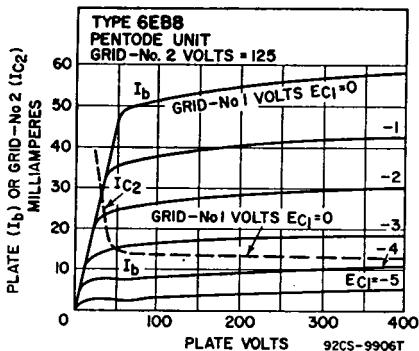

Refer to chart at end of section.

6EC4A/EY500

Refer to chart at end of section.
For replacement use type 6EH4A.

6EH4

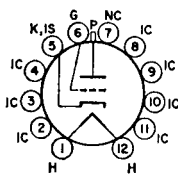

12FA

BEAM TRIODE

6EH4A

Duodecar type used as a shunt regulator in the high-voltage power supply of color television receivers. Outlines section, 16G; requires duodecar 12-contact socket. For high-voltage and X-ray safety considerations, refer to page 93. This type is electrically identical with type 6EJ4A.

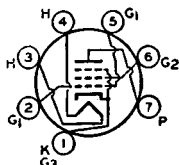

7CV

POWER PENTODE

6EH5

25EH5, 50EH5

Miniature type used in the audio output stage of radio and television receivers and in phonographs. Outlines section, 5D; requires miniature 7-contact socket. Types 25EH5 and 50EH5 are identical with type 6EH5 except for heater ratings.

Heater Voltage (ac/dc)	6EH5	25EH5	50EH5	
Heater Current	6.3	25	50	volts
Heater-Cathode Voltage:	1.2	0.3	0.15	ampere
Peak value	±200 max	±200 max	±200 max	volts
Average value	100 max	100 max	100 max	volts
Direct Interelectrode Capacitances (Approx.):				
Grid No.1 to Plate			0.65	pF
Grid No.1 to Cathode, Heater, Grid No.2, and Grid No.3			17	pF
Plate to Cathode, Heater, Grid No.2, and Grid No.3			9	pF

Class A₁ Amplifier

MAXIMUM RATINGS (Design-Maximum Values)

Plate Voltage	150	volts
Grid-No.2 (Screen-Grid) Voltage	130	volts
Plate Dissipation	5.5	watts
Grid-No.2 Input	2	watts
Bulb Temperature (At hottest point)	220	°C

TYPICAL OPERATION

Plate Supply Voltage	110	volts
Grid-No.2 Supply Voltage	115	volts
Cathode-Bias Resistor	62	ohms
Peak AF Grid-No.1 Voltage	3	volts

Zero-Signal Plate Current	42	mA
Maximum-Signal Plate Current	42	mA
Zero-Signal Grid-No.2 Current	11.5	mA
Maximum-Signal Grid-No.2 Current	14.5	mA
Plate Resistance (Approx.)	11000	ohms
Transconductance	14600	μ mhos
Load Resistance	3000	ohms
Total Harmonic Distortion	7	per cent
Maximum-Signal Power Output	1.4	watts

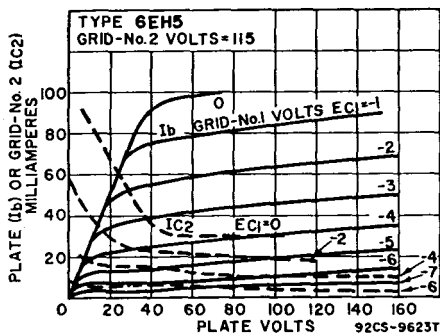
**MAXIMUM CIRCUIT VALUES**

Grid-No.1-Circuit Resistance:		
For fixed-bias operation	0.1	megohm
For cathode-bias operation	0.5	megohm

Push-Pull Class AB₁ Audio-Frequency Power Amplifier

MAXIMUM RATINGS (Same as for Class A₁ audio-frequency power amplifier)

TYPICAL OPERATION (Values are for two tubes)

Plate Supply Voltage	140	volts
Grid-No.2 Supply Voltage	120	volts
Cathode-Bias Resistor	68	ohms
Peak AF Grid-No.1 Voltage	9.4	volts
Zero-Signal Plate Current	47	mA
Maximum-Signal Plate Current	51	mA
Zero-Signal Grid-No.2 Current	11	mA
Maximum-Signal Grid-No.2 Current	17.7	mA
Effective Load Resistance (Plate-to-plate)	6000	ohms
Total Harmonic Distortion	5	per cent
Maximum-Signal Power Output	3.8	watts

MAXIMUM CIRCUIT VALUES

Grid-No.1-Circuit Resistance:		
For fixed-bias operation	0.1	megohm
For cathode-bias operation	0.5	megohm

6EH7

Refer to chart at end of section.
For replacement use type 6EH7/EF183.

**6EH7 /
EF183**

3EH7/XF183,
4EH7/LF183

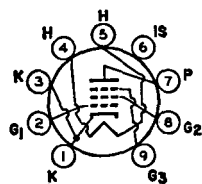
**SEMIREMOTE-CUTOFF
PENTODE****9AQ**

Miniature types used as if-amplifier tubes in color and black-and-white television receivers. Outlines section, 6C; requires miniature 9-contact socket. Types 3EH7/XF183 and 4EH7/LF183 are identical with type 6EH7/EF183 except for heater ratings.

	3EH7/ XF183	4EH7/ LF183	6EH7/ EF183	
Heater Voltage (ac/dc)	3.4	4.4	6.3	volts
Heater Current	0.6	0.45	0.3	ampere
Peak Heater-Cathode Voltage	±150 max	±150 max	±150 max	volts
Direct Interelectrode Capacitances:				
Grid No.1 to Plate			0.005 max	pF
Grid No.1 to Cathode, Heater, Grid No.2, Grid No.3, and Internal Shield			9	pF
Plate to Cathode, Heater, Grid No.2, Grid No.3, and Internal Shield			3	pF

Class A, Amplifier

MAXIMUM RATINGS (Design-Center Values)

Plate Supply Voltage	550	volts
Plate Voltage	250	volts
Grid-No.3 (Suppressor-Grid) Voltage, Positive value	0	volts
Grid-No.2 (Screen-Grid) Supply Voltage	550	volts
Grid-No.2 Voltage	250	volts
Cathode Current	20	mA
Plate Dissipation	2.5	watts
Grid-No.2 Input	0.65	watt

CHARACTERISTICS

Plate Voltage	200	volts
Grid No.3	Connected to cathode at socket	volts
Grid-No.2 Voltage	90	volts
Grid-No.1 Voltage	-2	volts
Plate Resistance (Approx.)	0.5	megohm
Transconductance	12500	μmhos
Plate Current	12	mA
Grid-No.2 Current	4.5	mA

TYPICAL OPERATION

Plate Voltage	200	200	200	200	volts
Grid No.3	Connected to cathode at socket				
Grid-No.2 Supply Voltage	200	200	200	200	volts
Grid-No.2 Series Resistor	22000	22000	22000	22000	ohms
Grid-No.1 Voltage	-19.5	-9.5	-6.5	-2	volts
Transconductance	125	625	1250	12500	μmhos
RMS Grid-No.1 Voltage, for cross-modulation factor of 0.01	450	160	100	—	mV

MAXIMUM CIRCUIT VALUE

Grid-No.1-Circuit Resistance	1	megohm
------------------------------------	---	--------

Refer to chart at end of section.

6EH8

Refer to chart at end of section.

6EJ4A

Refer to chart at end of section.

6EJ7

For replacement use type 6EJ7/EF184.

**6EJ7/
EF184**

3EJ7/XF184,
4EJ7/LF184

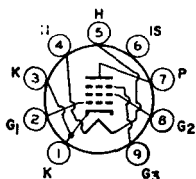

9AQ

SHARP-CUTOFF PENTODE

Miniature types used as if-amplifier tubes in color and black-and-white television receivers. Outlines section, 6C; requires miniature 9-contact socket. Types 3EJ7/XF184 and 4EJ7/LF184 are identical with type 6EJ7/EF184 except for heater ratings.

	3EJ7/ XF184	4EJ7/ LF184	6EJ7/ EF184	
Heater Voltage (ac/dc)	3.4	4.4	6.3	volts
Heater Current	0.6	0.45	0.3	ampere
Peak Heater-Cathode Voltage	±150 max	±150 max	±150 max	volts

Direct Interelectrode Capacitances:

Grid No.1 to Plate	0.005 max	pF
Grid No.1 to Cathode, Heater, Grid No.2, Grid No.3, and Internal Shield	10	pF
Plate to Cathode, Heater, Grid No.2, Grid No.3, and Internal Shield	3	pF

Class A₁ Amplifier

MAXIMUM RATINGS (Design-Center Values)

Plate Supply Voltage	550	volts
Plate Voltage	250	volts
Grid-No.2 (Screen-Grid) Supply Voltage	550	volts
Grid-No.2 Voltage	250	volts
Cathode Current	25	mA
Plate Dissipation	2.5	watts
Grid-No.2 Input	0.9	watt

CHARACTERISTICS

Plate Voltage	190	200	volts
Grid No.3	Connected to cathode at socket		
Grid-No.2 Voltage	190	200	volts
Grid-No.1 Voltage	-2.35	-2.5	volts
Plate Resistance (Approx.)	0.35	0.35	megohm
Transconductance	15000	15000	μmhos
Plate Current	10	10	mA
Grid-No.2 Current	4.1	4.1	mA

MAXIMUM CIRCUIT VALUE

Grid-No.1-Circuit Resistance	1	megohm
------------------------------------	---	--------

6EL4
6EL4A

Refer to chart at end of section.
For replacement use type 6BK4C/6EL4A.

6EM5
8EM5

BEAM POWER TUBE

Miniature type used as vertical-deflection amplifier in television receivers utilizing picture tubes having diagonal deflection angles of 110 degrees. Outlines section, 6G; requires miniature 9-contact socket. Type 8EM5 is identical with type 6EM5 except for heater ratings.

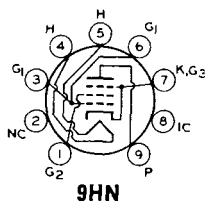

Heater Voltage (ac/dc)	6EM5 6.3	8EM5 8.4	volts
Heater Current	0.8	0.6	ampere
Heater Warm-up Time (Average)	—	11	seconds
Heater-Cathode Voltage:			
Peak value	±200 max	±200 max	volts
Average value	100 max	100 max	volts
Direct Interelectrode Capacitances:			
Grid No.1 to Plate		0.7 max	pF
Grid No.1 to Cathode, Heater, Grid No.2, and Grid No.3		10	pF
Plate to Cathode, Heater, Grid No.2, and Grid No.3		5.1	pF

Class A₁ Amplifier

CHARACTERISTICS

Plate Voltage	60	250	volts
Grid-No.2 Voltage	250	250	volts
Grid-No.1 Voltage	0	-18	volts
Mu Factor, Grid No.1 to Grid No.2	—	8.7	
Plate Resistance	—	0.05	megohm
Transconductance	—	5100	μmhos
Plate Current	180*	40	mA
Grid-No.2 Current	30*	3	mA
Grid-No.1 Voltage (Approx.) for plate current of 0.2 mA	—	-37	volts

* These values can be measured by a method involving a recurrent waveform such that the maximum ratings of the tube will not be exceeded.

Vertical-Deflection Oscillator and Amplifier

For operation in a 525-line, 30-frame system

MAXIMUM RATINGS (Design-Center Values)

DC Plate Voltage	315	volts
Peak Positive-Pulse Plate Voltage# (Absolute Maximum)	2200 ^A	volts
Grid-No.2 (Screen-Grid) Voltage	285	volts
Peak Negative-Pulse Grid-No.1 (Control-Grid) Voltage	250	volts
Peak Cathode Current	210	mA
Average Cathode Current	60	mA
Plate Dissipation	10	watts
Grid-No.2 Input	1.5	watts
Bulb Temperature (At hottest point)	250	°C

MAXIMUM CIRCUIT VALUE

Grid-No.1-Circuit Resistance	2.2	megohms
------------------------------	-----	---------

Pulse duration must not exceed 15% of a vertical scanning cycle (2.5 milliseconds).

^A Under no circumstances should this absolute value be exceeded.

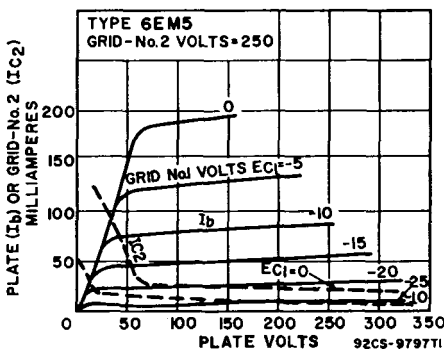
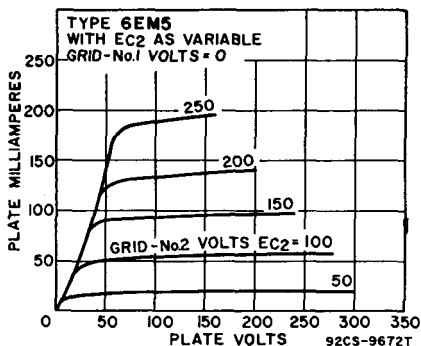

Refer to chart at end of section.
For replacement use type 6EM7/6EA7.

6EM7

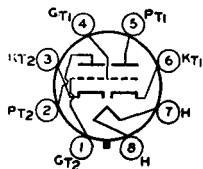

6EM7/6EA7

10EM7,
13EM7/15EA7

DUAL TRIODE

Glass octal type used as combined vertical-deflection amplifier and vertical-deflection oscillator in color and black-and-white television receivers. Outlines section, 13A; requires octal socket. For curve of average plate characteristics, Unit No.1, refer to type 6DR7 (Unit No.1). Types 10EM7, and 13EM7/15EA7 are identical with type 6EM7/6EA7 except for heater ratings.

	6EM7/6EA7	10EM7	13EM7/15EA7	
Heater Voltage (ac/dc)	6.3	9.7	13	volts
Heater Current	0.925	0.6	0.45	ampere
Heater Warm-up Time (Average)	—	11	11	seconds
Heater-Cathode Voltage:				
Peak value	±200 max	±200 max	±200 max	volts
Average value	100 max	100 max	100 max	volts
Direct Interelectrode Capacitances (Approx.):	Unit No.1	Unit No.2		
Grid to Plate	4.8	10		pF
Grid to Cathode and Heater	2.2	7		pF
Plate to Cathode and Heater	0.6	1.8		pF

Class A₁ Amplifier

CHARACTERISTICS

	Unit No.1	Unit No.2	
Plate Voltage	250	150	volts
Grid Voltage	-3	-20	volts
Amplification Factor	64	5.4	
Plate Resistance (Approx.)	40000	750	ohms
Transconductance	1600	7200	μ mhos
Plate Current	1.4	50	mA
Plate Current, for plate voltage of 60 volts and zero grid voltage	—	95	mA
Plate Current, for grid voltage of -28 volts	—	10	mA
Grid Voltage (Approx.):			
For plate current of 10 μ A	-5.5	—	volts
For plate current of 100 μ A	—	-45	volts

Vertical-Deflection Oscillator and Amplifier

For operation in a 525-line, 30-frame system

MAXIMUM RATINGS (Design-Maximum Values)

	Unit No.1 Oscillator	Unit No.2 Amplifier	
DC Plate Voltage	330	330	volts
Peak Positive-Pulse Plate Voltage#	—	1500	volts
Peak Negative-Pulse Grid Voltage	400	250	volts
Peak Cathode Current	77	175	mA
Average Cathode Current	22	50	mA
Plate Dissipation	1.5	10	watts

MAXIMUM CIRCUIT VALUES

Grid-Circuit Resistance:	Unit No.1	Unit No.2	
For grid-resistor-bias operation	2.2	2.2	megohms
For cathode-bias operation	2.2	2.2	megohms

Pulse duration must not exceed 15% of a vertical scanning cycle (2.5 milliseconds).

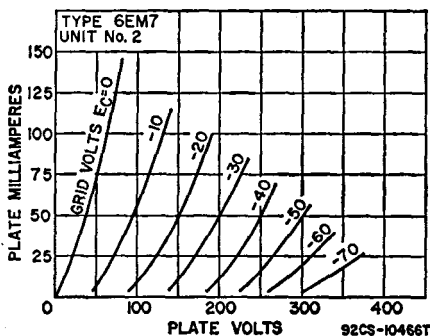

6EN4

SHARP-CUTOFF
BEAM TRIODE

Glass octal type used as a shunt voltage-regulator tube in the high-voltage power supply of color television receivers. Outlines section, 21B; requires octal socket. Socket terminals 3, 4, and 8 should not be used as tie points. For high voltage and X-ray safety considerations, refer to page 93.

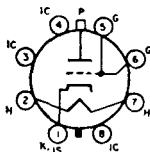

8NJ

Heater Voltage (ac/dc)	6.3	volts
Heater Current	0.2	ampere
Peak Heater-Cathode Voltage	—450* max	volts
Direct Interelectrode Capacitances (Approx.):‡		
Grid to Plate	1	pF
Plate to Cathode and Heater	2.6	pF
Grid to Cathode and Heater	1	pF

* Series impedance should be used with the cathode to limit the cathode current under prolonged short-circuit conditions to 450 mA.

‡ Without external shield.

Shunt Voltage-Regulator Service

MAXIMUM RATINGS (Design-Maximum Values)

DC Plate Voltage	30000	volts
Unregulated DC Supply Voltage	60000	volts
DC Grid Voltage	-135	volts
Peak Grid Voltage [‡]	-440	mA
Average Plate Current	1.6	mA
Plate Dissipation	40	watts

TYPICAL OPERATION

Unregulated DC Supply Voltage	36000	volts
Equivalent Resistance of Unregulated Supply	11	megohms
Voltage Divider Values:		
R ₁ (5 watts)	220	megohms
R ₂ (2 watts)	1	megohm
R ₃ (0.5 watt)	0.82	megohm
DC Reference Voltage Supply	200	volts
Equivalent Resistance of Reference Voltage	1000	ohms
Effective Grid-Plate Transconductance	200	μmhos
DC Plate Current for Load Current of 0 mA	1000	μA
DC Plate Current for Load Current of 1 mA	45	μA
Regulated DC Output Voltage for Load Current of 0 mA	25000	volts
Regulated DC Output Voltage for Load Current of 1 mA	24500	volts
Amplification Factor	2000	

MAXIMUM CIRCUIT VALUE

Grid-Circuit Resistance	3	megohms
-------------------------------	---	---------

■ For interval of 20 seconds maximum during equipment warm-up period.

CHARACTERISTICS RANGE VALUES

	Note	Min	Max	
Grid Voltage (1)	1	-7	—	volts
Grid Voltage (2)	2	—	-40	volts
Grid-Voltage Change	3	—	9	volts

Note 1: With dc plate voltage of 30000 volts and dc plate current of 1 mA.

Note 2: With dc plate voltage of 30000 volts and dc plate current of 0.1 mA.

Note 3: Difference between grid voltage (1) and grid voltage (2).

X-RADIATION CHARACTERISTIC

X-Radiation, Maximum:
 Statistical value controlled on a lot sampling basis 0.5 mR/hr

Caution—Operation of this tube outside of the maximum values indicated above may result in either temporary or permanent changes in the X-radiation characteristic of the tube. Equipment design must be such that these maximum values are not exceeded.

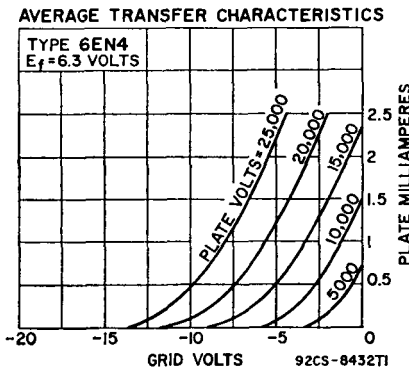

Refer to chart at end of section.

6EQ7

6ER5

3ER5

HIGH-MU TRIODE

Miniature type with frame grid used in vhf tuners of color and black-and-white television receivers. Outlines section 5C; requires miniature 7-contact socket. Type 3ER5 is identical to type 6ER5 except for heater ratings.

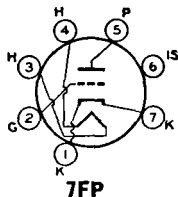

	3ER5	6ER5	
Heater Voltage (ac/dc)	2.8	6.3	volts
Heater Current	0.45	0.18	ampere
Peak Heater-Cathode Voltage	±100 max	±100 max	volts
Direct Interelectrode Capacitances:	Unshielded	Shielded*	
Grid to Plate	0.38	0.36	pF
Grid to Cathode, Heater, and Internal Shield	4.4	4.4	pF
Plate to Cathode, Heater, and Internal Shield	3	4	pF
Grid to Heater	0.28 max	0.28 max	pF
Plate to Cathode	0.24	0.2Δ	pF
Cathode to Grid	3.1	3.1Δ	pF
Heater to Cathode	2.5	2.5Δ	pF

* With external shield connected to cathode except as noted.

Δ With external shield connected to ground.

Class A₁ Amplifier**MAXIMUM RATINGS (Design-Center Values)**

Plate Voltage	250	volts
Grid Voltage, Negative-bias value	50	volts
Cathode Current	20	mA
Plate Dissipation	2.2	watts

CHARACTERISTICS

Plate Voltage	200	volts
Grid Voltage	-1.2	volts
Amplification Factor	80	
Plate Resistance (Approx.)	8000	ohms
Transconductance	10500	μmhos
Plate Current	10	mA
Grid Voltage (Approx.) for transconductance of 500 μmhos	-3.8	volts
Grid Voltage (Approx.) for transconductance of 100 μmhos	-5.6	volts

MAXIMUM CIRCUIT VALUE

Grid-Circuit Resistance	1	megohm
-------------------------	---	--------

6ES5

Refer to chart at end of section.

6ES8

Refer to chart at end of section.

**6ES8/
ECC189****VARIABLE-MU TWIN TRIODE**

Miniature type used as cascode-type amplifier in tuners of television receivers. Outlines section, 6B; requires miniature 9-contact socket.

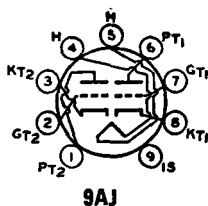
**9AJ**

	6.3	
Heater Voltage (ac/dc)	6.3	volts
Heater Current	0.365	ampere
Direct Interelectrode Capacitances:	Unshielded	Shielded*
Grid to Plate (Each Unit)	1.9	1.9
Plate to Cathode (Each Unit)	0.18	0.17
Heater to Cathode (Each Unit)	3	3Δ
Plate of Unit No.2 to Plate of Unit No.1	0.04 max	0.015 max
Plate of Unit No.2 to Grid of Unit No.1	0.003 max	0.003 max
Grid of Unit No.1 to Cathode of Unit No.2	0.002 max	0.002 max

* With external shield connected to cathode of unit under test except as noted.

Δ With external shield connected to ground.

Class A₁ Amplifier (Each Unit)

CHARACTERISTICS

Plate Voltage	90	90	90	volts
Grid Voltage	-1.2	-5	-9	volts
Plate Resistance (Approx.)	2500	—	—	ohms
Transconductance	12500	625	125	μmhos
Plate Current	15	—	—	mA

Cascode-Type Amplifier

MAXIMUM RATINGS (Design-Maximum Values)

Plate Supply Voltage with plate current of 0 mA	550	volts
Plate Voltage (Each unit)	130	volts
Grid Voltage, Negative-bias value (Each unit)	50	volts
Cathode Current (Each unit)	22	mA
Plate Dissipation (Each unit)	1.8	watts
Heater-Cathode Voltage:		
Unit No.1:*		
RMS voltage between cathode and heater	50	volts
Unit No.2:*		
RMS voltage between cathode and heater*	50	volts
DC voltage between cathode and heater*	130	volts

TYPICAL OPERATION in a cascode-type circuit■

Supply Voltage	180	volts
Plate Current	15	mA
Transconductance	12500	μmhos
Noise Figure*	6.5	dB
Grid Voltage (Approx.) for transconductance of 125 μmhos	-9	volts
Input Voltage for cross-modulation factor of 0.01 and transconductance of 125 μmhos	500	mV

MAXIMUM CIRCUIT VALUE

Grid-Circuit Resistance (Each unit)	1	megohm
-------------------------------------------	---	--------

* Grounded-cathode input unit—pins 6, 7, and 8.

■ Grounded-grid output unit—pins 1, 2, and 3.

• Cathode positive with respect to heater.

■ With grid of output unit connected to a voltage divider.

* Measured with tube operating in a television tuner.

Refer to chart at end of section.

6E7

HIGH-MU TWIN TRIODE

6EU7

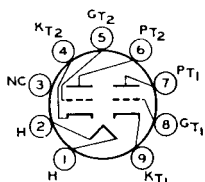

9LS

Miniature type used in high-gain, resistance-coupled, low-level audio-amplifier applications where low-hum and non-microphonic characteristics are important, such as microphone amplifiers and pre-amplifiers for phonographs. Outlines section, 6B; requires miniature 9-contact socket. For typical operation as a resistance-coupled amplifier, refer to Resistance-Coupled Amplifier section.

Heater Voltage (ac/dc)	6.3	volts
Heater Current	0.3	ampere
Heater-Cathode Voltage:		
Peak value	±200 max	volts
Average value	100 max	volts
Direct Interelectrode Capacitances (Each Unit, Approx.):		
Grid to Plate	1.5	pF
Grid to Cathode and Heater	1.6	pF
Plate to Cathode and Heater	0.2	pF
Equivalent Noise and Hum Voltage (Referenced to Grid, Each Unit):		
Average Value*	1.8	microvolts rms

* Measured in "true rms" units under the following conditions: Heater volts (ac), 6.3; center-tap of heater transformer grounded; plate supply volts, 250; plate load resistor, 100000 ohms; cathode resistor, 2700 ohms; cathode bypass capacitor, 100 μF; grid resistor, 0 ohms; amplifier frequency range, 25 to 10000 Hz.

Class A₁ Amplifier (Each Unit)

MAXIMUM RATINGS (Design-Maximum Values)

Plate Voltage	330	volts
Grid Voltage:		
Negative-bias value	55	volts
Positive-bias value	0	watts
Plate Dissipation	1.2	watts

CHARACTERISTICS

Plate Voltage	100	250	volts
Grid Voltage	-1	-2	volts
Amplification Factor	100	100	
Plate Resistance (Approx.)	80000	62500	ohms
Transconductance	1250	1600	μmbos
Plate Current	0.5	1.2	mA

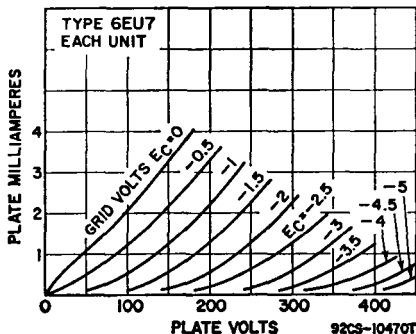

6EU8

Refer to chart at end of section.

6EV5

SHARP-CUTOFF TETRODE

Miniature type used as rf amplifier in vhf tuners of television receivers. Outlines section, 5C; requires miniature 7-contact socket.

Heater Voltage (ac/dc)	6.3	volts
Heater Current	0.2	ampere
Heater-Cathode Voltage:		
Peak value	±100 max	volts
Average value	50 max	volts
Direct Interelectrode Capacitances: ^a		
Grid No.1 to Plate	0.035 max	pF
Grid No.1 to Cathode, Heater, Grid No.2, and Internal Shield ..	4.5	pF
Plate to Cathode, Heater, Grid No.2, and Internal Shield ..	2.9	pF

^a With external shield connected to cathode.

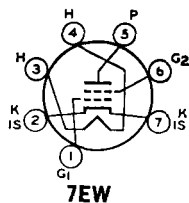

7EW

Class A₁ Amplifier

MAXIMUM RATINGS (Design-Maximum Values)

Plate Voltage	275	volts
Grid-No.2 (Screen-Grid) Supply Voltage	180	volts
Grid-No.2 Voltage	See curve page 300	
Grid-No.1 (Control-Grid) Voltage, Positive-bias value	0	volts
Cathode Current	20	mA
Plate Dissipation	3.25	watts
Grid-No.2 Input:		
For grid-No.2 voltages up to 90 volts	0.2	watt
For grid-No.2 voltages between 90 and 180 volts	See curve page 300	

CHARACTERISTICS

Plate Voltage	250	volts
Grid-No.2 Voltage	80	volts
Grid-No.1 Voltage	-1	volt
Plate Resistance (Approx.)	0.15	megohm
Transconductance	8800	μ mhos
Plate Current	11.5	mA
Grid-No.2 Current	0.9	mA
Grid-No.1 Voltage (Approx.) for transconductance of 100 μ mhos ..	-4.5	volts

MAXIMUM CIRCUIT VALUE

Grid-No.1-Circuit Resistance	0.5	megohm
------------------------------------	-----	--------

Refer to chart at end of section.

6EV7

6EW6

5EW6

SHARP-CUTOFF PENTODE

Miniature type used in the gain-controlled television picture receivers operating at an intermediate frequency in the order of 40 MHz. Outlines section, 5C; requires miniature 7-contact socket. Type 5EW6 is identical with type 6EW6 except for heater ratings.

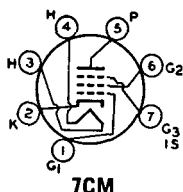

Heater Voltage (ac/dc)	5EW6	6EW6	
Heater Current	5.6	6.3	volts
Heater Warm-up Time (Average)	0.45	0.4	ampere
Heater-Cathode Voltage:			seconds
Peak value	± 200 max	± 200 max	volts
Average value	100 max	100 max	volts
Direct Interelectrode Capacitances:	Unshielded	Shielded*	
Grid No.1 to Plate	0.04 max	0.03 max	pF
Grid No.1 to Cathode, Heater, Grid No.2, Grid No.3, and Internal Shield	10	10	pF
Plate to Cathode, Heater, Grid No.2, Grid No.3, and Internal Shield	2.4	3.4	pF

* With external shield connected to cathode.

Class A₁ Amplifier

MAXIMUM RATINGS (Design-Maximum Values)

Plate Voltage	330	volts
Grid No.3 (Suppressor-Grid) Voltage, Positive value	0	volts
Grid-No.2 (Screen-Grid) Supply Voltage	330	volts
Grid-No.2 Voltage	See curve page 300	
Grid-No.1 (Control-Grid) Voltage, Positive-bias value	0	volts
Plate Dissipation	3.1	watts
Grid-No.2 Input:		
For grid-No.2 voltages up to 165 volts	0.65	watt
For grid-No.2 voltages between 165 and 330 volts	See curve page 300	

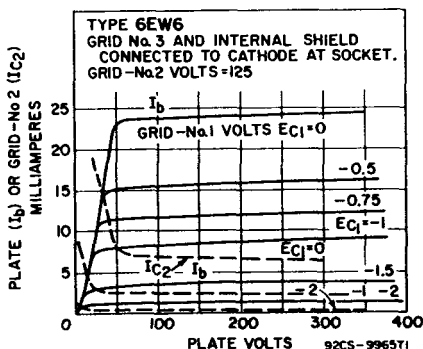

CHARACTERISTICS

Plate Supply Voltage	125	volts
Grid No.3	Connected to cathode at socket	
Grid-No.2 Supply Voltage	125	volts
Cathode-Bias Resistor	56	ohms
Plate Resistance (Approx.)	0.2	megohm
Transconductance	14000	μ mhos
Plate Current	11	mA
Grid-No.2 Current	3.2	mA
Grid-No.1 Voltage (Approx.) for plate current of 20 μ A	-3.5	volts

6EW7

10EW7, 15EW7

DUAL TRIODE

Miniature type used as combined vertical-deflection oscillator and vertical-deflector amplifier in television receivers. Outlines section, 6E, requires miniature 9-contact socket. For curve of average plate characteristics, Unit No.1, refer to type 6DE7 (Unit No.1). Types 10EW7 and 15EW7 are identical with type 6EW7 except for heater ratings.

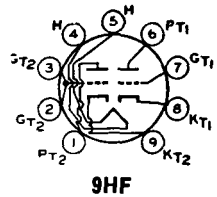

	6EW7	10EW7	15EW7	
Heater Voltage (ac/dc)	6.3	9.7	14.8	volts
Heater Current	0.9	0.6	0.45	ampere
Heater Warm-up Time	—	11	11	seconds
Heater-Cathode Voltage:				
Peak value	± 200 max	± 200 max	± 200 max	volts
Average value	100 max	100 max	100 max	volts
Direct Interelectrode Capacitances (Approx.):	Unit No.1	Unit No.2		
Grid to Plate	4.2	9		pF
Grid to Cathode and Heater	2.2	7		pF
Plate to Cathode and Heater	0.4	1.2		pF

Class A₁ Amplifier**CHARACTERISTICS**

	Unit No.1	Unit No.2	
Plate Voltage	250	150	volts
Grid Voltage	-11	-17.5	volts
Amplification Factor	17.5	6	
Plate Resistance (Approx.)	8750	800	ohms
Transconductance	2000	7500	μ mhos
Plate Current	5.5	45	mA
Plate Current for plate voltage of 60 volts and zero grid voltage	—	95	mA
Plate Current for grid voltage of -25 volts	—	8	mA
Grid Voltage (Approx.) for plate current of 10 μ A	-20	—	volts
Grid Voltage (Approx.) for plate current of 100 μ A	—	-40	volts

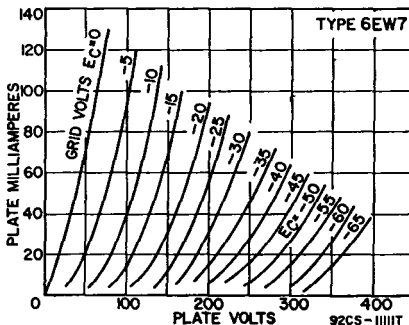

Vertical-Deflection Oscillator and Amplifier

For operation in a 525-line, 30-frame system

MAXIMUM RATINGS (Design-Maximum Values)	Unit No.1 Oscillator	Unit No.2 Amplifier	
DC Plate Voltage	330	330	volts
Peak Positive-Pulse Plate Voltage#	—	1500	volts
Peak Negative-Pulse Grid Voltage	400	250	volts
Peak Cathode Current	77	175	mA
Average Cathode Current	22	50	mA
Plate Dissipation	1.5	10	watts

MAXIMUM CIRCUIT VALUES

Grid-Circuit Resistance:			
For cathode-bias operation	2.2	2.2	megohms
For grid-resistor-bias operation	2.2	2.2	megohms

Pulse duration must not exceed 15% of a vertical scanning cycle (2.5 milliseconds).

- Refer to chart at end of section. **6EX6**
- Refer to chart at end of section. **6EY6**
- Refer to chart at end of section. **6EZ5**
- Refer to chart at end of section. **6EZ8**
- Refer to chart at end of section. **6F4**
- Refer to chart at end of section. **6F5**
- Refer to chart at end of section. **6F5GT**
- Refer to chart at end of section. **6F6**
- Refer to chart at end of section. **6F6G**
- Refer to chart at end of section. **6F6GT**
- Refer to chart at end of section. **6F7**
- Refer to chart at end of section. **6F8G**
- Refer to chart at end of section. **6FA7**

6FD7

13FD7

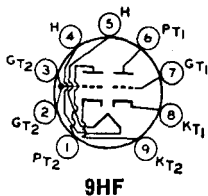

9HF

DUAL TRIODE

Miniature type containing high-mu and low-mu triode units used as combined vertical-deflection oscillator and vertical-deflection amplifier in television receivers. Outlines section, 6E; requires miniature 9-contact socket. Type 13FD7 is identical with type 6FD7 except for heater ratings.

	6FD7	13FD7	
Heater Voltage (ac/dc)	6.3	13	volts
Heater Current	0.925	0.45	ampere
Heater Warm-up Time (Average)	—	11	seconds
Heater-Cathode Voltage:			
Peak value	±200 max	±200 max	volts
Average value	100 max	100 max	volts
Direct Interelectrode Capacitances (Approx.):	Unit No.1	Unit No.2	
Grid to Plate	4.5	10	pF
Grid to Cathode and Heater	2.2	6.5	pF
Plate to Cathode and Heater	0.4	0.2	pF

Class A₁ Amplifier

CHARACTERISTICS	Unit No.1	Unit No.2	
Plate Voltage	250	60 150	volts
Grid Voltage	-3	0 -17.5	volts
Amplification Factor	64	— 6	
Plate Resistance (Approx.)	40000	— 800	ohms
Transconductance	1600	— 7500	μmhos
Plate Current	1.5	95* 40	mA
Grid Voltage (Approx.):			
For plate current of 10 μA	-5.5	— —	volts
For plate current of 100 μA	—	— -40	volts
Transconductance, For plate current of 1 mA	—	— 500	μmhos
Plate Current, For grid voltage of -25 volts	—	— 6	mA

* This value can be measured by a method involving a recurrent waveform such that the maximum ratings of the tube will not be exceeded.

Vertical-Deflection Oscillator and Amplifier

For operation in a 525-line, 30-frame system

MAXIMUM RATINGS (Design-Maximum Values)	Unit No.1 Oscillator	Unit No.2 Amplifier	
DC Plate Voltage	330	330	volts
Peak Positive-Pulse Plate Voltage#	—	1500	volts
Peak Negative-Pulse Grid Voltage	400	250	volts
Peak Cathode Current	70	175	mA
Average Cathode Current	20	50	mA
Plate Dissipation	1.5	10	watts

MAXIMUM CIRCUIT VALUES

Grid-Circuit Resistance:			
For grid-resistor-bias or cathode-bias operation	2.2	2.2	megohms

Pulse duration must not exceed 15% of a vertical scanning cycle (2.5 milliseconds).

6FE5

Refer to chart at end of section.

6FG6/EM84

Refer to chart at end of section.

6FG7

5FG7

MEDIUM-MU TRIODE—
SHARP-CUTOFF PENTODE

Miniature type used as combined oscillator and mixer tube in vhf color and black-and-white television receivers. Outlines section, 6B; requires miniature 9-contact socket. Type 5FG7 is identical with type 6FG7 except for heater ratings.

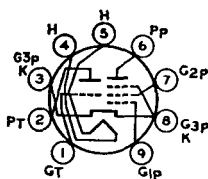

9GF

Heater Voltage (ac/dc)	5FG7 4.7	6FG7 6.3	volts
Heater Current	0.6	0.45	ampere
Heater Warm-up Time (Average)	11	11	seconds
Heater-Cathode Voltage:			
Peak value	±200 max	±200 max	volts
Average value	100 max	100 max	volts
Direct Interelectrode Capacitances:			
Triode Unit:			
Grid to Plate	1.8	1.8	pF
Grid to Cathode, Pentode Grid No.3, and Heater Plate to Cathode, Pentode Grid No.3, and Heater	3	3	pF
Pentode Unit:			
Grid No.1 to Plate	0.02 max	0.01 max	pF
Grid No.1 to Cathode, Grid No.3, Grid No.2, and Heater	5	5	pF
Plate to Cathode, Grid No.3, Grid No.2, and Heater	2.4	3.4	pF
Heater to Cathode, and Pentode Grid No.3	6	6*	pF

* With external shield connected to cathode except as noted.

* With external shield connected to ground.

Class A₁ Amplifier

MAXIMUM RATINGS (Design-Maximum Values)

	Triode Unit	Pentode Unit	
Plate Voltage	330	330	volts
Grid-No.2 (Screen-Grid) Supply Voltage	—	330	volts
Grid-No.2 Voltage	—	See curve page 300	
Grid-No.1 (Control-Grid) Voltage, Positive-bias value	0	0	volts
Plate Dissipation	2.5	3	watts
Grid-No.2 Input:			
For grid-No.2 voltages up to 165 volts	—	See curve page 300	
For grid-No.2 voltages between 165 and 330 volts	—	0.55	watt

CHARACTERISTICS

	Triode Unit	Pentode Unit	
Plate Voltage	125	100 125	volts
Grid-No.2 Voltage	—	100 125	volts
Grid-No.1 Voltage	-1	0 -1	volts
Amplification Factor	43	—	
Plate Resistance (Approx.)	5700	— 18000	ohms
Transconductance	7500	7400 6000	μmhos
Plate Current	13	— 11	mA
Grid-No.2 Current	—	— 4	mA
Grid-No.1 Voltage (Approx.) for plate current of 30 μA	-6.5	— -7.5	volts

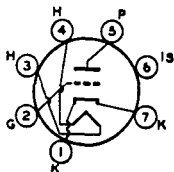

7FP

HIGH-MU TRIODE

Miniature type used as an rf amplifier in vhf tuners of color and black-and-white television receivers. Outlines section, 5C; requires 7-contact socket. Type 2FH5 is identical to type 6FH5 except for heater ratings.

6FH5

2FH5

	2FH5	6FH5	
Heater Voltage (ac/dc)	2.35	6.3	volts
Heater Current	0.6	0.2	ampere
Heater Warm-up Time (Average)	11	—	seconds
Peak Heater-Cathode Voltage	±100 max	±100 max	volts
Direct Interelectrode Capacitances (Approx.):	Unshielded	Shielded*	
Grid to Plate	0.52	0.52	pF
Grid to Cathode, Heater, and Internal Shield	3.2	3.2	pF
Plate to Cathode, Heater, and Internal Shield	3.2	4	pF

* With external shield connected to Pin 1.

Class A₁ Amplifier

MAXIMUM RATINGS (Design-Maximum Values)

Plate Voltage	150	volts
Grid Voltage, Positive-bias value	0	volts
Cathode Current	22	mA
Plate Dissipation	2.2	watts

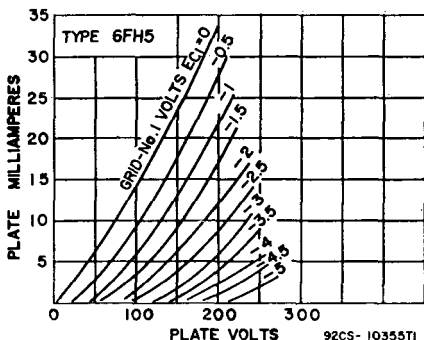

CHARACTERISTICS

Plate Voltage	135	volts
Grid Voltage	-1	volts
Plate Resistance (Approx.)	5600	ohms
Transconductance	9000	μ mhos
Amplification Factor	50	
Plate Current	11	mA
Grid Voltage (Approx.) for plate current of 100 μ A	-5.5	volts

MAXIMUM CIRCUIT VALUE

Grid-Circuit Resistance, for cathode-bias operation	1	megohm
-----------------------------------------------------------	---	--------

6FH8**MEDIUM-MU TRIODE—
THREE-PLATE TETRODE**

Miniature type used in complex-wave generator applications and in television receiver applications. Sharp-cutoff tetrode unit has pair of additional plates. Outlines section, 6B; requires 9-contact socket.

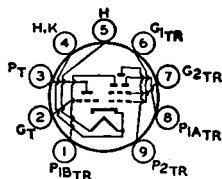
**9KP**

Heater Voltage (ac/dc)	6.3	volts
Heater Current	0.45	ampere
Direct Interelectrode Capacitances: ^o		
Triode Unit:		
Grid to Plate	1.4	pF
Grid to Cathode and Heater	2.6	pF
Plate to Cathode and Heater	1	pF
Tetrode Unit:		
Grid No.1 to Plate No.2	0.06 max	pF
Grid No.1 to Cathode, Heater, Grid No.2, Plate No.1A, and Plate No.1B	4.5	pF
Plate No.2 to Cathode, Heater, Grid No.2, Plate No.1A, and Plate No.1B	1.4	
Tetrode Grid No.1 to Triode Plate	0.35 max	pF
Tetrode Plate No.2 to Triode Plate	0.008 max	pF

^o With external shield connected to cathode.

Class A₁ Amplifier**Triode Unit**

Plate Voltage	100	volts
Grid Voltage	-1	volt
Amplification Factor	40	
Plate Resistance (Approx.)	7400	ohms
Transconductance	5400	μ mhos
Plate Current	7.9	mA
Grid Voltage (Approx.) for plate current of 100 μ A	-7	volts

Tetrode Unit with Plates No.1A and No.1B Connected to Cathode at Socket

MAXIMUM RATINGS (Design-Maximum Values)

Plate-No.2 Voltage	250	volts
Grid-No.2 Voltage	250	volts
Grid-No.1 Voltage	-2	volts
Plate-No.2 Resistance (Approx.)	0.75	megohm
Transconductance, Grid No.1 to Plate No.2	4400	μ mhos
Plate-No.2 Current	7.3	mA
Grid-No.2 Current	1.4	mA
Grid-No.1 Voltage (Approx.) for plate-No.2 current of 100 μ A	-7	volts

Complex-Wave Generator**MAXIMUM RATINGS (Design-Maximum Values)**

	Triode Unit	Tetrode Unit	
Plate Voltage	275	—	volts
Plate-No.1A Voltage	—	200	volts
Plate-No.1B Voltage	—	200	volts
Plate-No.2 Voltage	—	275	volts
Grid-No.2 (Screen-Grid) Supply Voltage	—	275	volts
Grid-No.2 Voltage	—	See curve page 300	
Grid-No.1 (Control-Grid) Voltage:			
Negative-bias value	-40	-40	volts
Positive-bias value	0	0	volts
Plate Dissipation	1.7	—	watts
Plate-No.1A Dissipation	—	0.3	watt
Plate-No.1B Dissipation	—	0.3	watt
Plate-No.2 Dissipation	—	2.3	watts

Grid-No.2 Input:		
For grid-No.2 voltages up to 137.5 volts	—	0.45 watt
For grid-No.2 voltages between 137.5 and 275 volts	—	See curve page 300

TYPICAL OPERATION WITH SEPARATE PLATE OPERATION

	Tetrode Unit	
Plates-No.1A, No.1B, and No.2 Voltage	100	volts
Grid-No.2 Voltage	50	volts
Grid-No.1 Voltage	—1	volts
Plate-No.1A Current	0.04	mA
Plate-No.1B Current	0.04	mA
Plate-No.2 Current	1.6	mA
Grid-No.2 Current	0.3	mA
Transconductance (Approx.):		
Grid No.1 to Plate No.1A	70	μmhos
Grid No.1 to Plate No.1B	70	μmhos
Grid No.1 to Plate No.2	2500	μmhos

MAXIMUM CIRCUIT VALUES

	Triode Unit	Tetrode Unit
Grid-No.1-Circuit Resistance, for fixed-bias operation	0.5	0.5 megohm

Refer to chart at end of section.

6FJ7

6FM7

13FM7/15FM7

DUAL TRIODE

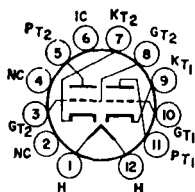

12EJ

Duodecar type used as combined vertical-deflection oscillator and vertical-deflection amplifier in color and black-and-white television receivers. Triode unit No.1 is used as an oscillator, and triode unit No.2 is used as an amplifier. Outlines section, 8C; requires duodecar 12-contact socket. Type 13FM7/15FM7 is identical with type 6FM7 except for heater ratings.

	6FM7	13FM7/15FM7	
Heater Voltage (ac/dc)	6.3	13	volts
Heater Current	1.05	0.45	amperes
Heater Warm-up Time (Average)	—	11	seconds
Heater-Cathode Voltage:			
Average value	±200 max	±200 max	volts
Peak value	100 max	100 max	volts

Class A₁ Amplifier

CHARACTERISTICS

	Unit No.1	Unit No.2	
Plate Voltage	250	175	volts
Grid Voltage	—3	—25	volts
Amplification Factor	66	5.5	
Plate Resistance (Approx.)	30000	920	ohms
Transconductance	2200	6000	μmhos
Plate Current	2	40	mA
Grid Voltage (Approx.) for plate current of 20 μA	—5.3	—	volts
Grid Voltage (Approx.) for plate current of 200 μA	—	—45	volts

Vertical-Deflection Oscillator and Amplifier

For operation in a 525-line, 30-frame system

	Unit No.1 Oscillator	Unit No.2 Amplifier	
DC Plate Voltage	350	500	volts
Peak Positive-Pulse Plate Voltage#	—	1500	volts
Peak Negative-Pulse Plate Voltage	400	250	volts
Peak Cathode Current	—	175	mA
Average Cathode Current	—	50	mA
Plate Dissipation†	1	10	watts

MAXIMUM CIRCUIT VALUES

Grid-Circuit Resistance:			
For fixed-bias operation	1	1	megohm
For cathode-bias operation	2.2	2.2	megohms

Pulse duration must not exceed 15% of a vertical scanning cycle (2.5 milliseconds).

† A bias resistor or other means is required to protect the tube in absence of excitation.

6FM8

Refer to chart at end of section.

6FQ5ARefer to chart at end of section.
For replacement use type 6GK5/6FQ5A.**6FQ7**

Refer to chart at end of section.

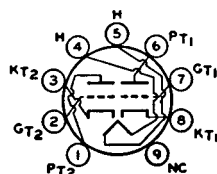
**6FQ7/
6CG7****MEDIUM-MU TWIN TRIODE****9LP****8FQ7/8CG7, 12FQ7**

Miniature type used as combined vertical- and horizontal-deflection oscillator in color and black-and-white television receivers. Outlines section, 6E; requires miniature 9-contact socket. Types 8FQ7/8CG7 and 12FQ7 are identical with type 6FQ7/6CG7 except for heater ratings. For typical operation as a resistance-coupled amplifier, refer to Resistance-Coupled Amplifier section.

	6FQ7/6CG7	8FQ7/8CG7	12FQ7	
Heater Voltage (ac/dc)	6.3	8.4	12.6	volts
Heater Current	0.6	0.45	0.3	ampere
Heater Warm-up Time (Average)	11	—	—	seconds
Heater-Cathode Voltage:				
Peak value	±200 max	±200 max	±200 max	volts
Average value	100 max	100 max	100 max	volts
Direct Interelectrode Capacitances (Approx.):				
		Unit No.1	Unit No.2	
Grid to Plate		3.6	3.8	pF
Grid to Cathode and Heater		2.4	2.4	pF
Plate to Cathode and Heater		0.34	0.26	pF
Plate of Unit No.1 to Plate of Unit No.2		1		pF

MAXIMUM RATINGS (Design-Maximum Values)

Plate Voltage	330	volts
Grid Voltage, Positive-bias value	0	volts
Cathode Current	22	mA
Plate Dissipation:		
For either plate	4	watts
For both plates with both units operating	5.7	watts

CHARACTERISTICS

Plate Voltage	90	250	volts
Grid Voltage	0	-8	volts
Amplification Factor	20	20	
Plate Resistance (Approx.)	6700	7700	ohms
Transconductance	3000	2600	μmhos
Plate Current	10	9	mA
Grid Voltage (Approx.) for plate current of 10 μA	-7	-18	volts
Plate Current for grid voltage of -12.5 volts	—	1.3	mA

MAXIMUM CIRCUIT VALUE

Grid Circuit Resistance, for fixed-bias operation	1	megohm
---------------------------------------------------	---	--------

Oscillator

For operation in a 525-line, 30-frame system

MAXIMUM RATINGS (Design-Maximum Values)	Vertical-Deflection Oscillator	Horizontal-Deflection Oscillator	
DC Plate Voltage	330	330	volts
Peak Negative-Pulse Grid Voltage	440	660	volts
Peak Cathode Current	77	330	mA
Average Cathode Current	22	22	mA
Plate Dissipation:			
For either plate	4	4	watts
For both plates with both units operating	5.7	5.7	watts

MAXIMUM CIRCUIT VALUES

Grid-Circuit Resistance	2.2	2.2	megohms
-------------------------	-----	-----	---------

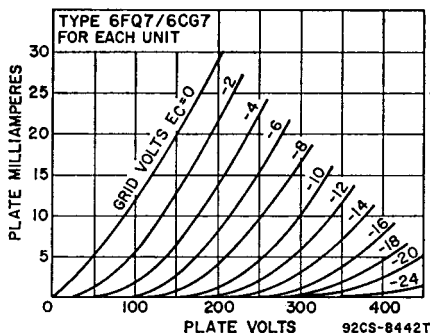

BEAM HEXODE

6FS5

2FS5, 3FS5

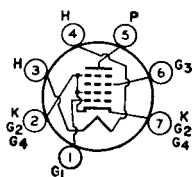

7GA

Miniature type used as rf-amplifier tube in vhf television receivers. In this tube, grid No.1 is the control grid, grid No.2 is a focusing grid, grid No.3 is the screen grid, and grid No.4 is the suppressor grid. Grid No.2 is internally connected to the cathode and grid No.4 and aligned with grid No.3 **Outlines section**, 5C; requires miniature 7-contact socket. Types 2FS5 and 3FS5 are identical with type 6FS5 except for heater ratings.

	2FS5	3FS5	6FS5	
Heater Voltage (ac/dc)	2.4	2.9	6.3	volts
Heater Current	0.6	0.45	0.2	ampere
Heater Warm-up Time (Average)	11	11	—	seconds
Heater-Cathode Voltage:				
Peak value	±200 max	±200 max	±200 max	volts
Average value	100 max	100 max	100 max	volts
Direct Interelectrode Capacitances:				
Grid No.1 to Plate	Shielded		Unshielded*	
Grid No.1 to Cathode, Heater, Grid No.2, Grid No.3, and Grid No.4	0.03		0.016	pF
Plate to Cathode, Heater, Grid No.2, Grid No.3, and Grid No.4	4.8		4.8	pF
	2		2.8	pF

* With external shield connected to pin 7.

Class A₁ Amplifier

MAXIMUM RATINGS (Design-Maximum Values)

Plate Voltage	300	volts
Grid-No.3 (Screen-Grid) Voltage	150	volts
Grid-No.1 (Control-Grid) Voltage:		
Negative-bias value	50	volts
Positive-bias value	0	volts
Cathode Current	20	mA
Plate Dissipation	3.25	watts
Grid-No.3 Input	0.15	watt

CHARACTERISTICS

Plate Voltage	275	volts
Grid-No.3 Voltage	135	volts
Grid-No.1 Voltage	—0.2	volt
Plate Resistance (Approx.)	0.24	megohm
Transconductance	10000	μmhos
Plate Current	9	mA
Grid-No.3 Current	0.17	mA
Grid-No.1 Voltage (Approx.) for transconductance of 100 μmhos	—5	volts

MAXIMUM CIRCUIT VALUE

Grid-No.1-Circuit Resistance, for fixed-bias operation	0.5	megohm
--------------------------------------------------------------	-----	--------

Refer to chart at end of section.

6FV6

6FV8	Refer to chart at end of section.
6FV8A	Refer to chart at end of section. For replacement use type 6BR8A/6FV8A.
6FW5	Refer to chart at end of section.
6FW8	Refer to chart at end of section.
6FY5/EC97	Refer to chart at end of section.

6FY7**DUAL TRIODE**

11FY7, 15FY7

Duodecar type used as combined vertical-deflection oscillator and vertical-deflection amplifier in television receivers. Triode unit No.1 is used as an oscillator, and triode unit No.2 is used as an amplifier. Outlines section, 8D; requires duodecar 12-contact socket. Types 11FY7 and 15FY7 are identical with type 6FY7 except for heater ratings.

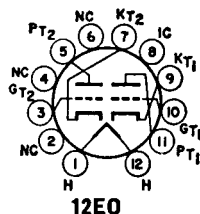

	6FY7	11FY7	15FY7	
Heater Voltage (ac/dc)	6.3	11	14.7	volts
Heater Current	1.05	0.6	0.45	amperes
Heater Warm-up Time (Average)	—	11	11	seconds
Heater-Cathode Voltage:				
Peak value	±200 max	±200 max	±200 max	volts
Average value	100 max	100 max	100 max	volts

Class A₁ Amplifier**CHARACTERISTICS**

	Unit No.1	Unit No.2	
Plate Voltage	250	150	volts
Grid Voltage	-3	-17.5	volts
Amplification Factor	65	6	
Plate Resistance (Approx.)	40500	920	ohms
Transconductance	1600	6500	μmhos
Plate Current	1.4	35	mA
Grid Voltage (Approx.) for plate current of 30 μA	-5.5	—	volts
Grid Voltage (Approx.) for plate current of 50 μA	—	-36	volts
Plate Current (Approx.) for grid voltage of -25 volts	—	6	mA

Vertical-Deflection Oscillator and Amplifier

For operation in a 525-line, 30-frame system

MAXIMUM RATINGS (Design-Maximum Values)	Unit No.1 Oscillator	Unit No.2 Amplifier	
DC Plate Voltage	330	275	volts
Peak Positive-Pulse Plate Voltage*	—	2000	volts
Peak Negative-Pulse Plate Voltage	400	250	volts
Peak Cathode Current	70	175	mA
Average Cathode Current	20	50	mA
Plate Dissipation	1	7†	watts

MAXIMUM CIRCUIT VALUES

Grid-Circuit Resistance	2.2	2.2	megohms
# Pulse duration must not exceed 15% of a vertical scanning cycle (2.5 milliseconds).			
† A bias resistor or other means is required to protect the tube in absence of excitation.			

6G6G Refer to chart at end of section.

6G11 Refer to chart at end of section.

6GB3A For replacement use type 6BQ6GTB/6CU6.

6GB5 Refer to chart at end of section.

6GB5/ EL500

13GB5/XL500,
18GB5/LL500
27GB5/PL500

BEAM POWER TUBE

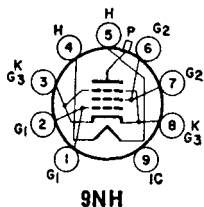

9NH

Magnoval type used as horizontal-deflection amplifier in television receivers. Outlines section, 35B; requires neonoval 9-contact socket. Typical instantaneous characteristics (measured with recurrent waveform such that maximum ratings are not exceeded): plate volts, 75; grid-No.2 volts, 200; grid-No.1 volts, -10; plate mA, 440; grid-No.2 mA, 37. Types 13GB5/XL500, 18GB5/LL500 and 27GB5/PL500 are identical with type 6GB5/EL500 except for heater ratings.

	6GB5/ EL500	13GB5/ XL500	18GB5/ LL500	27GB5/ PL500	
Heater Voltage (ac/dc)	6.3	13.3	18	27	volts
Heater Current	1.38	0.6	0.45	0.3	amperes
Heater-Cathode Voltage:					
Peak value	±250 max	±250 max	±250 max	±250 max	volts
Average value	125 max	125 max	125 max	125 max	volts

Horizontal-Deflection Amplifier

For operation in a 525-line, 30-frame system

MAXIMUM RATINGS (Design-Maximum Values)

DC Plate Voltage	275	volts
Peak Positive-Pulse Plate Voltage#	7700	volts
DC Grid-No.2 (Screen-Grid) Voltage	275	volts
Average Cathode Current	275	mA
Plate Dissipation ^A	17	watts
Grid-No.2 Input [*]	5	watts

MAXIMUM CIRCUIT VALUES

Grid-No.1-Circuit Resistance:

Without grid current	0.5	megohm
With grid current (horizontal-output service only)	2.2	megohms

Pulse duration must not exceed 15% of a horizontal scanning cycle (10 microseconds).

^A A bias resistor or other means is required to protect the tube in absence of excitation.

^{*} Grid-No.2 input may reach 6 watts for plate-dissipation values below 11 watts.

For replacement use type 6GW6/6DQ6B.

6GB6

For replacement use type 6GW6/6DQ6B.

6GB7

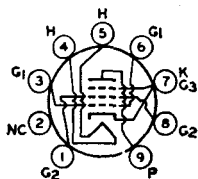

9EU

BEAM POWER TUBE

6GC5

Miniature type used in color and black-and-white television receiver applications and as output tube in audio-amplifier applications. Outlines section, 6E, requires miniature 9-contact socket.

Heater Voltage (ac/dc)	6.3	volts
Heater Current	1.2	amperes
Heater-Cathode Voltage:		
Peak value	±200 max	volts
Average value	100 max	volts
Direct Interelectrode Capacitances (Approx.):		
Grid No.1 to Plate	0.9	pF
Grid No.1 to Cathode, Heater, Grid No.2, and Grid No.3	18	pF
Plate to Cathode, Heater, Grid No.2, and Grid No.3	7	pF

Class A₁ Amplifier

MAXIMUM RATINGS (Design-Maximum Values)

Plate Voltage	220	volts
Grid-No.2 (Screen-Grid) Voltage	140	volts
Plate Dissipation	12	watts
Grid-No.2 Input	1.4	watts

TYPICAL OPERATION AND CHARACTERISTICS

Plate Voltage	110	200	volts
Grid-No.2 Voltage	110	125	volts
Grid-No.1 Voltage	-7.5	—	volts
Cathode-Bias Resistor	—	180	ohms
Peak AF Grid-No.1 Voltage	7.5	8.5	volts
Zero-Signal Plate Current	49	46	mA
Maximum-Signal Plate Current	50	47	mA
Zero-Signal Grid-No.2 Current	4	2.2	mA
Maximum-Signal Grid-No.2 Current	10	8.5	mA
Plate Resistance (Approx.)	13000	28000	ohms
Transconductance	8000	8000	μmhos
Load Resistance	2000	4000	ohms
Total Harmonic Distortion	10	10	per cent
Maximum-Signal Power Output	2.1	3.8	watts

MAXIMUM CIRCUIT VALUES

Grid-No.1-Circuit Resistance:		
For fixed-bias operation	0.1	megohm
For cathode-bias operation	0.5	megohm

6GE5

BEAM POWER TUBE

12GE5, 17GE5

Duodecar type used as horizontal-deflection-amplifier tube in television receivers. Outlines section, 15A; requires duodecar 12-contact socket. Types 12GE5 and 17GE5 are identical with type 6GE5 except for heater ratings.

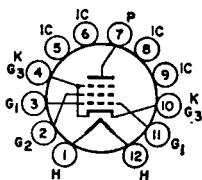

12BJ

Heater Voltage (ac/dc)	6GE5	12GE5	17GE5	
Heater Current	6.3	12.6	16.8	volts
Heater Warm-up Time (Average)	1.2	0.6	0.45	amperes
Heater-Cathode Voltage:				seconds
Peak value	±200 max	±200 max	±200 max	volts
Average value	100 max	100 max	100 max	volts

Class A₁ Amplifier

CHARACTERISTICS

	Pentode Connection	Triode* Connection	
Plate Voltage	60	250	volts
Grid-No.2 (Screen-Grid) Voltage	150	150	volts
Grid-No.1 (Control-Grid) Voltage	0	-22.5	volts
Amplification Factor	—	4.4	
Plate Resistance (Approx.)	—	18000	ohms
Transconductance	—	7300	μmhos
Plate Current	345*	65	mA
Grid-No.2 Current	27*	1.8	mA
Grid-No.1 Voltage (Approx.) for plate current of 1 mA	—	-42	volts

* Grid No.2 tied to plate.

* This value can be measured by a method involving a recurrent waveform such that the maximum ratings of the tube will not be exceeded.

Horizontal-Deflection Amplifier

For operation in a 525-line, 30-frame system

MAXIMUM RATINGS (Design-Maximum Values)

DC Plate Supply Voltage	770	volts
Peak Positive-Pulse Plate Voltage#	6500	volts
Peak Negative-Pulse Plate Voltage	1500	volts
DC Grid-No.2 Voltage	220	volts
Peak Negative-Pulse Grid-No.1 Voltage	330	volts

DC Grid-No.1 Voltage	—55	volts
Peak Cathode Current	550	mA
Average Cathode Current	175	mA
Plate Dissipation†	17.5	watts
Grid-No.2 Input	3.5	watts
Bulb Temperature (At hottest point)	200	°C

MAXIMUM CIRCUIT VALUE

Grid-No.1 Circuit Resistance	1	megohm
------------------------------------	---	--------

Pulse duration must not exceed 15% of a horizontal scanning cycle (10 microseconds).

† A bias resistor or other means is required to protect the tube in absence of excitation.

Refer to chart at end of section.

6GF5

Refer to chart at end of section.

6GF7

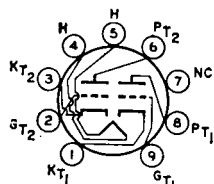

9QD

DUAL TRIODE

6GF7A

10GF7A, 13GF7A

Novar types used as combined vertical-deflection oscillator and vertical-deflection amplifiers in color and black-and-white television receivers. **Outlines section, 30A**; requires novar 9-contact socket. For curves of average plate characteristics for Unit No.1 and Unit No.2, refer to types 6DR7 (Unit No.1) and 6EM7, respectively. Types 10GF7A and 13GF7A are identical with type 6GF7A except for heater ratings.

	6GF7A	10GF7A	13GF7A	
Heater Voltage (ac/dc)	6.3	9.7	13	volts
Heater Current	0.985	0.6	0.45	ampere
Heater Warm-up Time (Average)	—	11	11	seconds
Heater-Cathode Voltage:				
Peak value	±200 max	±200 max	±200 max	volts
Average value	100 max	100 max	100 max	volts
Direct Interelectrode Capacitances (Approx.):		Unit No.1	Unit No.2	
Grid to Plate		4.6	9	pF
Grid to Cathode and Heater		2.4	6.5	pF
Plate to Cathode and Heater		0.26	1.4	pF

Class A₁ Amplifier

CHARACTERISTICS	Unit No.1	Unit No.2	
Plate Voltage	250	150	volts
Grid Voltage	—3	—20	volts
Amplification Factor	64	5.4	
Plate Resistance (Approx.)	40000	750	ohms
Transconductance	1600	7200	μmhos
Grid Voltage (Approx.):			
For plate current of 10 μA	—5.5	—	volts
For plate current of 100 μA	—	—45	volts
Plate Current	1.4	50	mA
For plate voltage of 60 volts and zero grid voltage	—	95	mA
For grid voltage of —28 volts	—	10	mA

Vertical-Deflection Oscillator and Amplifier

For operation in a 525-line, 30-frame system

MAXIMUM RATINGS (Design-Maximum Values)	Unit No.1 Oscillator	Unit No.2 Amplifier	
DC Plate Voltage	330	330	volts
Peak Positive-Pulse Plate Voltage (Absolute Maximum)#	—	1500*	volts
Peak Negative-Pulse Grid Voltage	400	250	volts
Peak Cathode Current	77	175	mA
Average Cathode Current	22	50	mA
Plate Dissipation	1.5	11	watts

MAXIMUM CIRCUIT VALUES

Grid-Circuit Resistance:

For grid-resistor-bias or cathode-bias operation 2.2 2.2 megohms

• Under no circumstances should this absolute value be exceeded.

Pulse duration must not exceed 15% of a vertical scanning cycle (2.5 milliseconds).

Refer to chart at end of section.

6GH8

6GH8A

5GH8A, 9GH8A

**MEDIUM-MU TRIODE—
SHARP-CUTOFF PENTODE**

Miniature type used in multivibrator-type horizontal-deflection circuits and for agc-amplifier or sync-separator applications in color and black-and-white television receivers. Outlines section, 6B; requires miniature 9-contact socket. Types 5GH8A and 9GH8A are identical with type 6GH8A except for heater ratings.

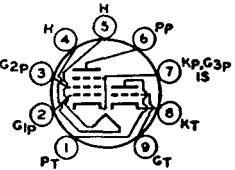

9AE

	5GH8A	6GH8A	9GH8A	
Heater Voltage (ac/dc)	4.7	6.3	9.45	volts
Heater Current	0.6	0.45	0.3	ampere
Heater Warm-up Time (Average)	11	11	—	seconds
Heater-Cathode Voltage:				
Peak value	±200 max	±200 max	±200 max	volts
Average value	100 max	100 max	100 max	volts
Direct Interelectrode Capacitances:		Unshielded	Shielded	
Triode Unit:				
Grid to Plate		1.7	1.7	pF
Grid to Cathode, Heater, Pentode Grid No.3, Pentode Cathode, and Internal Shield		3	3.2	pF
Plate to Cathode, Heater, Pentode Grid No.3, Pentode Cathode, and Internal Shield		1.4	1.9	pF
Heater to Cathode		3	3	pF
Pentode Unit:				
Grid No.1 to Plate		0.02 max	0.01 max	pF
Grid No.1 to Cathode, Heater, Grid No.2, Grid No.3, and Internal Shield		5	5	pF
Plate to Cathode, Heater, Grid No.2, Grid No.3, and Internal Shield		2.6	3.4	pF
Heater to Cathode, Grid No.3, and Internal Shield		3	3	pF

Class A₁ Amplifier

CHARACTERISTICS

	Triode Unit	Pentode Unit	
Plate Voltage	125	125	volts
Grid-No.2 Voltage	—	125	volts
Grid-No.1 Voltage	—1	—1	volts
Amplification Factor	46	—	
Plate Resistance (Approx.)	5400	200000	ohms
Transconductance	8500	7500	μmhos
Plate Current	13.5	12	mA
Grid-No.2 Current	—	4	mA
Grid-No.1 Voltage (Approx.) for plate current of 10 μA	—8	—8	volts

Horizontal-Deflection Oscillator

For operation in a 525-line, 30-frame system

MAXIMUM RATINGS (Design-Maximum Values)

	Triode Unit	Pentode Unit	
Plate Voltage	330	350	volts
Grid-No.2 (Screen-Grid) Voltage	—	330	volts
Grid-No.1 (Control-Grid) Voltage:			
Positive-bias value	0	0	volts
Peak negative value	—	175	volts
Peak Cathode Current	—	300	mA
Average Cathode Current	—	20	mA
Plate Dissipation	2.5	2.5	watts
Grid-No.2 Input	—	0.55	watt

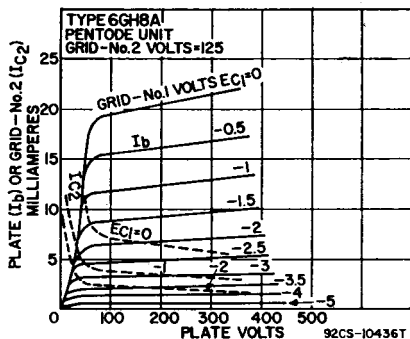
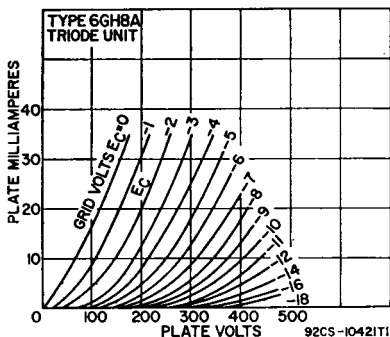

MAXIMUM CIRCUIT VALUES

Grid-No.1-Circuit Resistance:

For fixed-bias operation	2.2	2.2	megohms
For cathode-bias operation	2.2	2.2	megohms

Refer to chart at end of section.

6GJ5

BEAM POWER TUBE

6GJ5A

12GJ5A, 17GJ5A

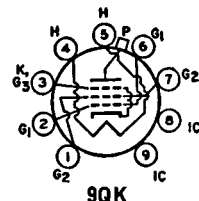

Novar type used in high-efficiency horizontal-deflection-amplifier circuits of television receivers. Outlines section, 18A; requires novar 9-contact socket. For curve of average characteristics see type 6GW6. Types 12GJ5A and 17GJ5A are identical with type 6GJ5A except for heater ratings.

Heater Voltage (ac/dc)	6GJ5A	12GJ5A	17GJ5A	volts
Heater Current	1.2	0.6	0.45	amperes
Heater Warm-up Time (Average)	—	11	11	seconds
Heater-Cathode Voltage:				
Peak value	±200 max	±200 max	±200 max	volts
Average value	100 max	100 max	100 max	volts
Direct Interelectrode Capacitances (Approx.):				
Grid No.1 to Plate	—	—	0.26	pF
Grid No.1 to Cathode, Heater, Grid No.2, and Grid No.3	—	—	15	pF
Plate to Cathode, Heater, Grid No.2, and Grid No.3	—	—	6.5	pF

Class A₁ Amplifier

CHARACTERISTICS

	Triode Connection	Pentode Connection		
Plate Voltage	150	60	250	volts
Grid-No.2 Voltage	150	150	150	volts
Grid-No.1 Voltage	-22.5	0	-22.5	volts
Mu-Factor, Grid No.2 to Grid No.1	4.4	—	—	
Plate Resistance (Approx.)	—	—	15000	ohms
Transconductance	—	—	7100	μmhos
Plate Current	—	390*	70	mA
Grid-No.2 Current	—	32*	2.1	mA
Grid-No.1 Voltage for plate current of 1 mA	—	—	-42	volts

* This value can be measured by a method involving a recurrent waveform such that the maximum ratings of the tube will not be exceeded.

Horizontal-Deflection Amplifier

For operation in a 525-line, 30-frame system

MAXIMUM RATINGS (Design-Maximum Values)

DC Plate Supply Voltage	770	volts
Peak Positive-Pulse Plate Voltage#	6500	volts
Peak Negative-Pulse Plate Voltage	1500	volts

DC Grid-No.2 Voltage	220	volts
DC Grid-No.1 Voltage	-55	volts
Peak Negative-Pulse Grid-No.1 Voltage	330	volts
Peak Cathode Current	550	mA
Average Cathode Current	175	mA
Plate Dissipation*	17.5	watts
Grid-No.2 Input	3.5	watts
Bulb Temperature (at hottest point)	240	°C

MAXIMUM CIRCUIT VALUE

Grid-No.1-Circuit Resistance:

For grid-resistor-bias operation 1 megohm

Pulse duration must not exceed 15% of a horizontal scanning cycle (10 microseconds).

* A bias resistor or other means is required to protect the tube in absence of excitation.

6GJ7

Refer to chart at end of section.

**6GJ7/
ECF801**4GJ7/XCF801
5GJ7/LCF801
8GJ7/PCF801**MEDIUM-MU TRIODE—
SHARP-CUTOFF PENTODE**

Miniature types used as combined oscillator and mixer tubes in color and black-and-white television receivers utilizing an intermediate frequency in the order of 40 MHz. Outlines section, 6J; requires miniature 9-contact socket. Types 4GJ7/XCF801, 5GJ7/LCF801, and 8GJ7/PCF801 are identical with type 6GJ7/ECF801 except for heater ratings.

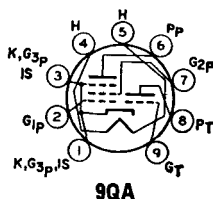
**9QA**

except for heater ratings.

	4GJ7/ XCF801	5GJ7/ LCF801	6GJ7/ ECF801	8GJ7/ PCF801	
Heater Voltage (ac/dc)					
Heater Current	4.1	5.6	6.3	8	volts
Peak Heater-Cathode Voltage ^Δ	0.6	0.45	0.41	0.3	ampere
	±110 max	±110 max	±100 max	±110 max	volts

Class A₁ Amplifier**MAXIMUM RATINGS (Design-Maximum Values)**

	Triode Unit	Pentode Unit	
Plate-Supply Voltage	600	600	volts
DC Plate Voltage	140	275	volts
Grid-No.2 (Screen-Grid) Supply Voltage	—	600	volts
DC Grid-No.2 Voltage	—	275	volts
DC Grid-No.1 (Control-Grid) Voltage	—	-50	volts
Cathode Current	22	20	mA
Plate Dissipation	1.8	2.4	watts
Grid-No.2 Input*	—	0.55	watt

CHARACTERISTICS

DC Plate Voltage	100	170	volts
DC Grid-No.2 Voltage	—	120	volts
DC Grid-No.1 Voltage	-3	-1.2	volts
Amplification Factor	20	55*	
Plate Resistance (Approx.)	—	0.35	megohm
Transconductance	9000	11000	μmhos
Plate Current	15	10	mA
Grid-No.2 Current	—	3	mA
Grid-No.1 Voltage for grid-No.1 current of 0.3 μA	-1.3 max	-1.3 max	volts
Grid-No.1-Circuit Resistance:			
For fixed-bias operation	0.5	1	megohm
For cathode-bias operation	0.5	2.2	megohms

^Δ The hum should be minimized in intercarrier applications by limiting the heater-cathode voltage to 100 volts rms, and in AM receivers to 50 volts rms.

* Grid No.2 to grid No.1, approximate value.

• When control-grid bias is between -1.5 and -2 volts, screen-grid dissipation is limited to 0.50 watt. When this bias is greater than -2 volts, maximum screen-grid dissipation is 0.36 watt.

6GJ8

Refer to chart at end of section.

For replacement use type 6GK5/6FQ5A.

6GK5

**6GK5/
6FQ5A**

2GK5/2FQ5A,
3GK5, 4GK5

HIGH-MU TRIODE

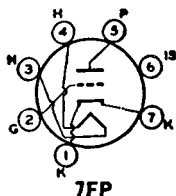

Miniature type with frame grid used as grounded-cathode rf-amplifier tube in vhf tuners of color and black-and-white television receivers. Outlines section, 5C; requires miniature 7-contact socket. Types 2GK5/2FQ5A, 3GK5, and 4GK5 are identical with type 6GK5/6FQ5A except for heater ratings.

	2GK5/2FQ5A	3GK5	4GK5	6GK5/6FQ5A	
Heater Voltage (ac/dc)	2.3	2.8	4	6.3	volts
Heater Current	0.6	0.45	0.3	0.18	ampere
Heater Warm-up Time (Average)	11	11	11	—	seconds
Peak Heater-Cathode Voltage	±100 max	±100 max	±100 max	±100 max	volts
Direct Interelectrode Capacitances (Approx.):°					
Grid to Plate				0.52	pF
Grid to Cathode, Heater, and Internal Shield				5	pF
Plate to Cathode, Heater, and Internal Shield				3.5	pF
Heater to Cathode				2.5*	pF

- ° With external shield connected to cathode, except as noted.
- * With external shield and internal shield connected to ground.

Class A₁ Amplifier

MAXIMUM RATINGS (Design-Maximum Values)

Plate Voltage	200	volts
Grid Voltage:		
Negative-bias value	50	volts
Positive-bias value	0	volts
Average Cathode Current	22	mA
Plate Dissipation	2.5	watts

CHARACTERISTICS

Plate Voltage	135	volts
Grid Voltage	-1	volts
Amplification Factor	78	
Plate Resistance (Approx.)	5400	ohms
Transconductance	15000	μmhos
Plate Current	11.5	mA
Input Resistance*	275	ohms
Input Capacitance*	11.2	pF
Noise Figure†	4.7	dB
Grid Voltage (Approx.) for transconductance of 150 μmhos	-4.2	volts
Grid Voltage (Approx.) for transconductance of 1500 μmhos	-2.5	volts

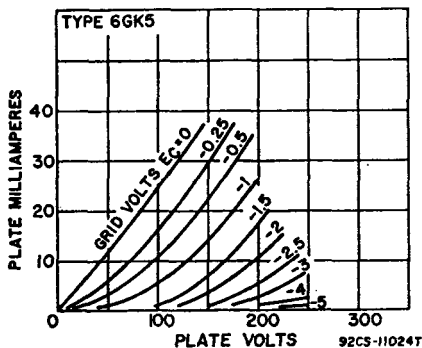

MAXIMUM CIRCUIT VALUE

Grid-Circuit Resistance, for cathode-bias operation 1 megohm
 • Measured at 200 MHz with heater volts = 6.3 and plate effectively grounded for rf voltages.
 † For a neutralized triode amplifier at a frequency of 200 MHz with signal source impedance adjusted for minimum noise output.

6GK6**POWER PENTODE****10GK6, 16GK6**

Miniature type used in the output stage of audio amplifying equipment and also in the video output stage of color and black-and-white television receivers. Outlines section, 6G; requires miniature 9-contact socket. Types 10GK6 and 16GK6 are identical with type 6GK6 except for heater ratings.

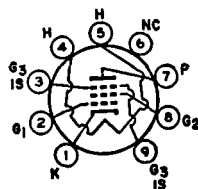
**9GK**

	6GK6	10GK6	16GK6	
Heater Voltage (ac/dc)	6.3	10	16	volts
Heater Current	0.76	0.45	0.3	ampere
Heater Warm-up Time (Average)	—	11	11	seconds
Peak Heater-Cathode Voltage	±100 max	±100 max	±100 max	volts
Direct Interelectrode Capacitances:				
Grid No.1 to Plate			0.14 max	pF
Grid No.1 to Cathode, Heater, Grid No.2, Grid No.3, and Internal Shield			10	pF
Plate to Cathode, Heater, Grid No.2, Grid No.3, and Internal Shield			7	pF

Class A₁ Amplifier**MAXIMUM RATINGS (Design-Maximum Values)**

Plate Supply Voltage	605	volts
Plate Voltage	330	volts
Grid-No.2 Supply Voltage	605	volts
Grid-No.2 (Screen-Grid) Voltage	330	volts
Grid-No.1 (Control-Grid) Voltage, Negative-bias value	100	volts
Cathode Current	65	mA
Plate Dissipation	13.2	watts
Grid-No.2 Input, Peak	4	watts
Grid-No.2 Input, Average	2	watts

CHARACTERISTICS AND TYPICAL OPERATION

Plate Supply Voltage	250	volts
Grid-No.2 Supply Voltage	250	volts
Cathode-Bias Resistor	135	ohms
Mu-Factor, Grid No.2 to Grid No.1	19	
Plate Resistance (Approx.)	38000	ohms
Transconductance	11300	μmhos
Peak AF Grid-No.1 Voltage	7.3	volts
Zero-Signal Plate Current	48	mA
Maximum-Signal Plate Current	50.6	mA
Zero-Signal Grid-No.2 Current	5.5	mA
Maximum-Signal Grid-No.2 Current	10	mA
Effective Load Resistance	5200	ohms
Total Harmonic Distortion	10	per cent
Maximum-Signal Power Output	5.7	watts

Push-Pull Class AB₁ and Class B Amplifier**MAXIMUM RATINGS (Same as for Class A₁ Amplifier)****TYPICAL OPERATION (Values are for two tubes)**

	Class AB ₁		Class B		
	250	300	250	300	
Plate Voltage	250	300	250	300	volts
Grid-No.2 Voltage	250	300	250	300	volts
Grid-No.1 Voltage	—	—	-11.6	-14.7	volts
Cathode-Bias Resistor	130	130	—	—	ohms
Peak AF Grid-No.1-to-Grid-No.1 Voltage	22.4	28	22.4	28	volts
Zero-Signal Plate Current	62	72	20	15	mA
Maximum-Signal Plate Current	75	92	75	92	mA
Zero-Signal Grid-No.2 Current	7	8	2.2	1.6	mA
Maximum-Signal Grid-No.2 Current	15	22	15	22	mA
Effective Load Resistance (plate to plate)	8000	8000	8000	8000	ohms
Total Harmonic Distortion	3	4	3	4	per cent
Maximum-Signal Power Output	11	17	11	17	watts

MAXIMUM CIRCUIT VALUES

Grid-No.1-Circuit Resistance:

For fixed-bias operation 0.3
 For cathode-bias operation 1

megohm
 megohm

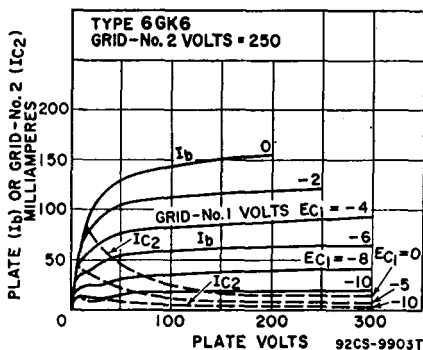

For replacement use type 6AU4GTA.

6GK17

Refer to chart at end of section.

6GL7

Refer to chart at end of section.

6GM5

**SEMIREMOTE-CUTOFF
 PENTODE**

6GM6

5GM6

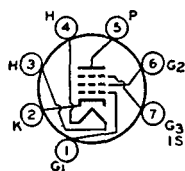

7CM

Miniature type used in gain-controlled picture-if stages of color and black-and-white television receivers operating at intermediate frequencies in the order of 40 MHz. Outlines section, 5C; requires 7-contact socket. Type 5GM6 is identical with type 6GM6 except for heater ratings.

	5GM6	6GM6	
Heater Voltage (ac/dc)	5.6	6.3	volts
Heater Current	0.45	0.4	ampere
Heater Warm-up Time (Average)	11	—	seconds
Heater-Cathode Voltage:			
Peak value	±200 max	±200 max	volts
Average value	100 max	100 max	volts
Direct Interelectrode Capacitances:	Unshielded	Shielded*	
Grid No.1 to Plate	0.036 max	0.026 max	pF
Grid No.1 to Cathode, Heater, Grid No.2, Grid No.3, and Internal Shield	10	10	pF
Plate to Cathode, Heater, Grid No.2, Grid No.3, and Internal Shield	2.4	3.4	pF

* With external shield connected to cathode.

Class A₁ Amplifier

MAXIMUM RATINGS (Design-Maximum Values)

Plate Voltage	330	volts
Grid-No.3 (Suppressor-Grid) Voltage, Positive value	0	volts
Grid-No.2 (Screen-Grid) Supply Voltage	330	volts
Grid-No.2 Voltage	See curve page 300	
Grid-No.1 (Control-Grid) Voltage, Positive-bias value	0	volts
Plate Dissipation	3.1	watts
Grid-No.2 Input:		
For grid-No.2 voltages up to 165 volts	0.65	watt
For grid-No.2 voltages between 165 and 330 volts	See curve page 300	

CHARACTERISTICS

Plate Supply Voltage	125	volts
Grid No.3	Connected to cathode at socket	
Grid-No.2 Supply Voltage	125	volts
Cathode-Bias Resistor	56	ohms
Plate Resistance (Approx.)	0.2	megohm
Transconductance	13000	μ mhos
Plate Current	14	mA
Grid-No.2 Current	3.4	mA
Grid-No.1 Voltage (Approx.) for transconductance of 60 μ mhos ..	-15	volts

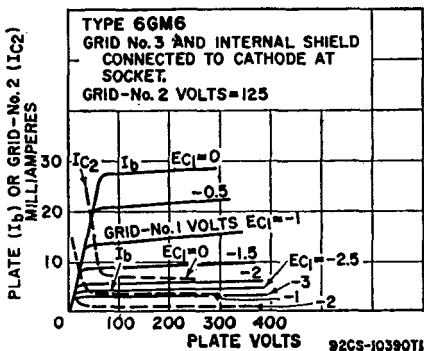

6GN8

8GN8/8EB8
10GN8

**HIGH-MU TRIODE—
SHARP-CUTOFF PENTODE**

Miniature type used in color and black-and-white television receiver applications. Triode unit is used as sync-separator, sync-clipper, phase inverter, or sound-if amplifier. Pentode unit is used in output stage of video amplifier. Outlines section, 6E; requires miniature 9-contact socket. For direct interelectrode capacitances, refer to type 6EB8; curve for average plate characteristics of triode unit is same as for type 6EB8. Types 8GN8/8EB8, and 10GN8 are identical with type 6GN8 except for heater ratings.

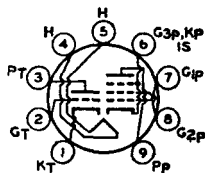

9DX

Heater Voltage (ac/dc)	6.3	8	10.5	volts
Heater Current	0.75	0.6	0.45	ampere
Heater Warm-up Time (Average)	—	11	11	seconds
Heater-Cathode Voltage:				
Peak value	± 200 max	± 200 max	± 200 max	volts
Average value	100 max	100 max	100 max	volts

Class A₁ Amplifier

MAXIMUM RATINGS (Design-Maximum Values)

	Triode Unit	Pentode Unit	
Plate Voltage	330	330	volts
Grid-No.2 (Screen-Grid) Supply Voltage	—	330	volts
Grid-No.2 Voltage	0	See curve page 300	
Grid-No.1 (Control-Grid) Voltage, Positive-bias value	—	0	volt
Plate Dissipation	1	5	watts
Grid-No.2 Input:			
For grid-No.2 voltages up to 165 volts	—	1.1	watts
For grid-No.2 voltages between 165 and 330 volts	—	See curve page 300	

CHARACTERISTICS

	Triode Unit	Pentode Unit		
Plate Supply Voltage	250	60	200	volts
Grid-No.2 Supply Voltage	—	150	150	volts
Grid-No.1 Voltage	-2	0	—	volts
Cathode-Bias Resistor	—	—	100	ohms
Amplification Factor	100	—	—	
Plate Resistance (Approx.)	37000	—	60000	ohms

	Triode Unit	Pentode Unit	
Transconductance	2700	11500	μ mhos
Plate Current	2	55*	mA
Grid-No.2 Current	—	18*	mA
Grid Voltage (Approx.) for plate current of 20 μ A	—5	—	volts
Grid-No.1 Voltage (Approx.) for plate current of 100 μ A	—	—10	volts

MAXIMUM CIRCUIT VALUES

Grid-No.1-Circuit Resistance:			
For fixed-bias operation	0.5	0.25	megohm
For cathode-bias operation	1	1	megohm

* This value can be measured by a method involving a recurrent waveform such that the maximum ratings of the tube will not be exceeded.

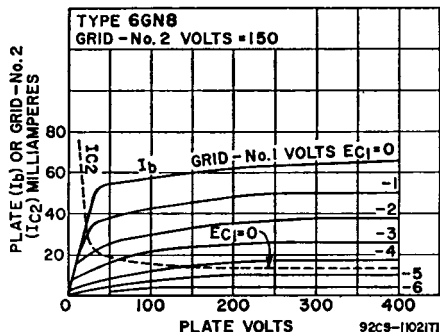

Refer to chart at end of section.

6GQ7

**MEDIUM-MU TRIODE—
SHARP-CUTOFF PENTODE**

6GS7

5GS7, 7GS7

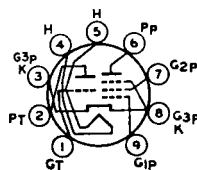

9GF

Miniature type used as a frequency changer in vhf television tuners. Outlines section, 6B; requires 9-contact socket. Types 5GS7 and 7GS7 are identical with type 6GS7 except for heater ratings. Heater: volts, 7.6; ampere, 0.3; maximum heater-cathode volts, \pm 100 peak, 100 average.

	5GS7	6GS7	7GS7	
Heater Voltage	5.4	6.3	7.6	volts
Heater Current	0.45	0.375	0.3	ampere
Heater-Cathode Voltage:				
Peak value	\pm 200 max	\pm 200 max	\pm 200 max	volts
Average value	100 max	100 max	100 max	volts

Class A₁ Amplifier

MAXIMUM RATINGS (Design-Center Values)

	Triode Unit	Pentode Unit	
Plate Voltage	125	250	volts
Grid-No.2 (Screen-Grid) Voltage	—	150	volts
Plate Dissipation	1.5	2	watts
Grid-No.2 Input	—	0.5	watt
Cathode Current	15	18	mA

CHARACTERISTICS

	Triode Unit	Pentode Unit	
Plate Voltage	100	170	volts
Grid-No.2 Voltage	—	150	volts
Grid-No.1 (Control-Grid) Voltage	—3	—1.2	volts
Plate Current	14	10	mA
Grid-No.2 Current	—	3.3	mA
Transconductance	5500	12000	μ mhos
Plate Resistance	—	0.35 min	megohm
Amplification Factor	17	—	

MAXIMUM CIRCUIT VALUES

Grid-No.1-Circuit Resistance	0.5	—	megohm
Grid-No.1-Circuit Resistance:			
For fixed-bias operation	—	0.25	megohm
For cathode-bias operation	—	0.5	megohm

Pentode Unit as Frequency Changer**CHARACTERISTICS**

Plate Voltage	190	volts
Grid-No.2 Supply Voltage	190	volts
Oscillator Voltage	2.3	volts (rms)
Grid-No.2 Circuit Resistance	0.018	megohm
Grid-No.1 Circuit Resistance	0.1	megohm
Plate Current	8.5	mA
Grid-No.2 Current	2.7	mA
Grid-No.1 Current	30	μ A
Plate Resistance	0.6	megohm
Conversion Transconductance	4500	μ mhos

Triode Unit as Oscillator**CHARACTERISTICS**

Plate Supply Voltage	190	volts
Plate Circuit Resistance	8200	ohms
Grid Circuit Resistance	10000	ohms
Oscillator Voltage	4.5	volts (rms)
Plate Current	12	mA
Transconductance	3500	μ mhos

6GT5

Refer to chart at end of section.

6GT5A

17GT5A

BEAM POWER TUBE

Novar type used as horizontal-deflection amplifier in television receivers. Outlines section, 31A; requires novar 9-contact socket. For curve of average characteristics, refer to type 6GW6. Type 17GT5A is identical with type 6GT5A except for heater ratings.

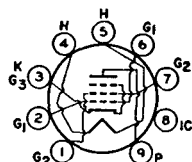
**9NZ**

	6GT5A	17GT5A	
Heater Voltage (ac/dc)	6.3	16.8	volts
Heater Current	1.2	0.45	ampere
Heater Warm-up Time (Average)	—	11	seconds
Heater-Cathode Voltage:			
Peak value	± 200 max	± 200 max	volts
Average value	100 max	100 max	volts
Direct Interelectrode Capacitances (Approx.):			
Grid No.1 to Plate		0.26	pF
Grid No.1 to Cathode, Heater, Grid No.2, and Grid No.3		15	pF
Plate to Cathode, Heater, Grid No.2, and Grid No.3		6.5	pF

Class A₁ Amplifier**CHARACTERISTICS**

	Triode Connection	Pentode Connection		
Plate Voltage	150	60	250	volts
Grid-No.2 (Screen-Grid) Voltage	150	150	150	volts
Grid-No.1 (Control-Grid) Voltage	-22.5	0	-22.5	volts
Mu Factor, Grid No.2 to Grid No.1	4.4	—	—	
Plate Resistance (Approx.)	—	—	15000	ohms
Transconductance	—	—	7100	μ mhos
Plate Current	—	390*	70	mA
Grid-No.2 Current	—	32*	2.1	mA
Grid-No.1 Voltage (Approx.) for plate current of 1 mA	—	—	-42	volts

* This value can be measured by a method involving a recurrent waveform such that the maximum ratings of the tube will not be exceeded.

Horizontal-Deflection Amplifier

For operation in a 525-line, 30-frame system

MAXIMUM RATINGS (Design-Maximum Values)

DC Plate Supply Voltage	770	volts
Peak Positive-Pulse Plate Voltage#	6500	volts

Peak Negative-Pulse Plate Voltage	1500	volts
DC Grid-No.2 Voltage	220	volts
DC Grid-No.1 Voltage	-55	volts
Peak Negative-Pulse Grid-No.1 Voltage	330	volts
Peak Cathode Current	550	mA
Average Cathode Current	175	mA
Plate Dissipation*	17.5	watts
Grid-No.2 Input	3.5	watts
Bulb Temperature (At hottest point)	240	°C

MAXIMUM CIRCUIT VALUE

Grid-No.1-Circuit Resistance, for grid-resistor-bias operation* 1 megohm

Pulse duration must not exceed 15% of a horizontal scanning cycle (10 microseconds).

* A bias resistor or other means is required to protect the tube in absence of excitation.

Refer to chart at end of section.

6GU5

MEDIUM-MU TWIN TRIODE

6GU7

8GU7

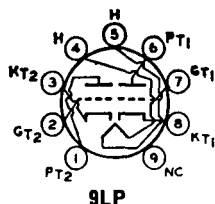

9LP

Miniature type used in the matrixing circuits of color and black-and-white television receivers and in phase-inverter, multivibrator, and general-purpose amplifier applications. Outlines section, 6E; requires miniature 9-contact socket. Type 8GU7 is identical with type 6GU7 except for heater ratings.

	6GU7	8GU7	
Heater Voltage (ac/dc)	6.3	8.4	volts
Heater Current	0.6	0.45	ampere
Heater Warm-up Time (Average)	11	11	seconds
Heater-Cathode Voltage:			
Peak value	±200 max	±200 max	volts
Average value	100 max	100 max	volts
Direct Interelectrode Capacitances (Approx.):	Unit No.1	Unit No.2	
Grid to Plate	3	3	pF
Grid to Cathode and Heater	3.4	3.6	pF
Plate to Cathode and Heater	0.44	0.34	pF
Plate of Unit No.1 to Plate of Unit No.2	1		pF

Class A₁ Amplifier

MAXIMUM RATINGS (Design-Maximum Values)

Plate Voltage	330	volts
Grid Voltage, Positive-bias value	0	volts
Plate Dissipation	3	watts

CHARACTERISTICS

Plate Voltage	250	volts
Grid Voltage	-10.5	volts
Amplification Factor	17	
Plate Resistance (Approx.)	5500	ohms
Transconductance	3100	μmhos

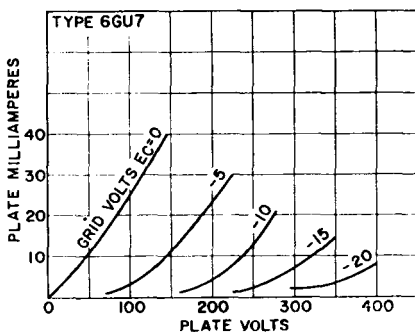

9205-1176071

Plate Current	11.5	mA
Grid Voltage (Approx.) for plate current of 50 μ A	-23	volts
Plate Current for grid voltage of -14 volts	4	mA
MAXIMUM CIRCUIT VALUE		
Grid-Circuit Resistance, for fixed-bias operation	1	megohm

6GV5

17GV5

BEAM POWER TUBE

Duodecar type used as horizontal-deflection amplifier in television receivers. Outlines section, 39A; requires duodecar 12-contact socket. Type 17GV5 is identical with type 6GV5 except for heater ratings.

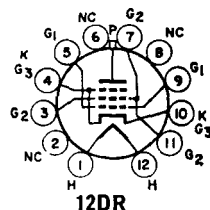

12DR

	6GV5	17GV5	
Heater Voltage (ac/dc)	6.3	16.8	volts
Heater Current	1.2	0.45	amperes
Heater Warm-up Time (Average)	—	11	seconds
Heater-Cathode Voltage:			
Peak value	± 200 max	± 200 max	volts
Average value	100 max	100 max	volts

Class A₁ Amplifier**CHARACTERISTICS**

	Pentode Connection		Triode* Connection		
Plate Voltage	5000	60	250	150	volts
Grid-No.2 (Screen-Grid) Voltage	150	150	150	150	volts
Grid-No.1 (Control-Grid) Voltage	—	0	-22.5	-22.5	volts
Plate Resistance (Approx.)	—	—	18000	—	ohms
Transconductance	—	—	7300	—	μ mhos
Amplification Factor	—	—	—	4.4	
Plate Current	—	345*	65	—	mA
Grid-No.2 Current	—	27*	1.8	—	mA
Grid-No.1 Voltage (Approx.) for plate current of 1 mA	-100	—	-42	—	volts

* Grid No.2 tied to plate.

† This value can be measured by a method involving a recurrent waveform such that the maximum ratings of the tube will not be exceeded.

Horizontal-Deflection Amplifier

For operation in a 525-line, 30-frame system

MAXIMUM RATINGS (Design-Maximum Values)

DC Plate Supply Voltage	770	volts
Peak Positive-Pulse Plate Voltage#	6500	volts
Peak Negative-Pulse Plate Voltage	1500	volts
DC Grid-No.2 Voltage	220	volts
Peak Negative-Pulse Grid-No.1 Voltage	330	volts
DC Grid-No.1 Voltage	-55	volts
Peak Cathode Current	550	mA
Average Cathode Current	175	mA
Plate Dissipation†	17.5	watts
Grid-No.2 Input	3.5	watts
Bulb Temperature (At hottest point)	220	$^{\circ}$ C

MAXIMUM CIRCUIT VALUE

Grid-No.1-Circuit Resistance	1	megohm
------------------------------------	---	--------

Pulse duration must not exceed 15% of a horizontal scanning cycle (10 microseconds).

† A bias resistor or other means is required to protect the tube in absence of excitation.

6GV8

Refer to chart at end of section.

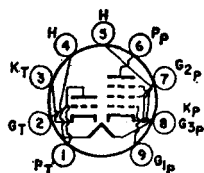

9LY

**HIGH-MU TRIODE—
POWER PENTODE**

**6GV8/
ECL85**

9GV8/XCL85,
10GV8/LCL85
18GV8/PCL85

Miniature type used for sync-amplifier and video-out-put applications in television receivers. Outlines section, 6G; requires miniature 9-contact socket. Types 9GV8/XCL85, 10GV8/LCL85, and 18GV8/PCL85 are identical with type 6GV8/ECL85 except for heater ratings.

	6GV8/ ECL85	9GV8/ XCL85	10GV8/ LCL85	18GV8/ PCL85	
Heater Voltage (ac/dc)	6.3	9.5	11.6	18	volts
Heater Current	0.9	0.6	0.45	0.3	ampere
Peak Heater-Cathode Voltage	±220 max	±200 max	±200 max	±200 max	volts

Class A₁ Amplifier

MAXIMUM RATINGS (Absolute-Maximum Values)

	Triode Unit	Pentode Unit	
Plate Supply Voltage	550	550	volts
Peak Plate Voltage ^o	—	2000	volts
DC Plate Voltage	250	250	volts
Grid-No.2 (Screen-Grid) Supply Voltage	—	550	volts
Grid-No.2 Voltage	—	250	volts
Peak Cathode Current*	200	—	mA
Average Cathode Current	15	75	mA
Plate Dissipation	0.5	7	watts
Grid-No.2 Input	—	2	watts

CHARACTERISTICS

Plate Voltage	100	50	65	170	volts
Grid-No.2 Voltage	—	170	210	170	volts
Grid-No.1 Voltage	—0.8	—1	—1	—15	volts
Amplification Factor	50	—	—	—	
Mu-Factor, Grid No.1 to Grid No.2	—	—	—	7	
Plate Resistance (Approx.)	7600	—	—	25000	ohms
Transconductance	6500	—	—	7500	μmhos
Plate Current	5	200*	240*	41	mA
Grid-No.2 Current	—	40*	50*	2.7	mA

MAXIMUM CIRCUIT VALUES

Grid-No.1-Circuit Resistance:			
For fixed-bias operation	1	1	megohm
For cathode-bias operation	3.3	2.2	megohms

^o Maximum pulse duration 5 per cent of a cycle with a maximum of 1 millisecond.

* Maximum pulse duration 200 microseconds. If a larger flyback is required, this value may be reduced to 100 mA with a maximum pulse duration of 400 microseconds.

• This value can be measured by a method involving a recurrent waveform such that the maximum tube ratings will not be exceeded.

Refer to chart at end of section.

For replacement use type 6GW6/6DQ6B.

6GW6

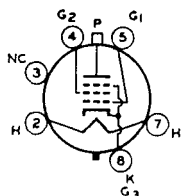

6AM

BEAM POWER TUBE

**6GW6/
6DQ6B**

12GW6/12DQ6B
17GW6/17DQ6B

Glass octal type used as horizontal-deflection amplifier in high-efficiency deflection circuits of television receivers. Outlines section, 20A; requires octal socket. Types 12GW6/12DQ6B and 17GW6/17DQ6B are identical with type 6GW6/6DQ6B except for heater ratings.

	6GW6/ 6DQ6B	12GW6/ 12DQ6B	17GW6/ 17DQ6B	
Heater Voltage (ac/dc)	6.3	12.6	16.8	volts
Heater Current	1.2	0.6	0.45	amperes
Heater Warm-up Time (Average)	—	11	11	seconds
Heater-Cathode Voltage:				
Peak value	±200 max	±200 max	±200 max	volts
Average value	100 max	100 max	100 max	volts
Direct Interelectrode Capacitances (Approx.):				
Grid No.1 to Plate			0.5	pF
Grid No.1 to Cathode, Heater, Grid No.2, and Grid No.3			17	pF
Plate to Cathode, Heater, Grid No.2, and Grid No.3			7	pF

Class A₁ Amplifier

CHARACTERISTICS	Triode Connection		Pentode Connection	
	Plate Voltage	150	60	
Grid-No.2 Voltage	150	150	150	volts
Grid-No.1 Voltage	-22.5	0	-22.5	volts
Mu-Factor, Grid No.2 to Grid No.1	4.4	—	—	
Plate Resistance (Approx.)	—	—	15000	ohms
Transconductance	—	—	7100	μmhos
Plate Current	—	390 ^c	70	mA
Grid-No.2 Current	—	32 ^o	2.1	mA
Grid-No.1 Voltage (Approx.) for plate current of 1 mA	—	—	-42	volts

^c This value can be measured by a method involving a recurrent waveform such that the maximum ratings of the tube will not be exceeded.

Horizontal-Deflection Amplifier

For operation in a 525-line, 30-frame system

MAXIMUM RATINGS (Design-Maximum Values)

DC Plate Supply Voltage	770	volts
Peak Positive-Pulse Plate Voltage#	6500	volts
Peak Negative-Pulse Plate Voltage	1500	volts
DC Grid-No.2 (Screen-Grid) Voltage	220	volts
DC Grid-No.1 (Control-Grid) Voltage	-55	volts
Peak Negative-Pulse Grid-No.1 Voltage	330	volts
Peak Cathode Current	550	mA

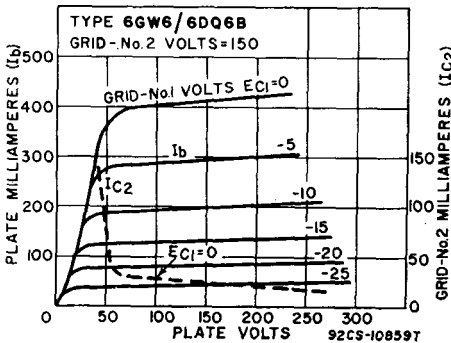

Average Cathode Current	175	mA
Plate Dissipation*	17.5	watts
Grid-No.2 Input	3.5	watts
Bulb Temperature (At hottest point)	240	°C

MAXIMUM CIRCUIT VALUES

Grid-No.1-Circuit Resistance, for grid-resistor-bias operation 1 megohm

Pulse duration must not exceed 15% of a horizontal scanning cycle (10 microseconds).

• A bias resistor or other means is required to protect the tube in absence of excitation.

6GW8/ ECL86

HIGH-MU TRIODE— SHARP-CUTOFF PENTODE

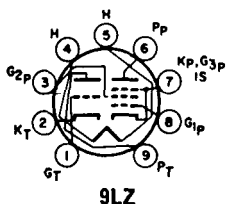

Miniature type used in preamplifier and audio output stages of audio equipment and television receivers. Outlines section, 6G; requires miniature 9-contact socket. Heater: volts (ac/dc), 6.3; amperes, 0.7; maximum heater-cathode volts, 100 peak.

9LZ

Class A₁ Amplifier

MAXIMUM RATINGS (Design-Center Values)	Triode Unit	Pentode Unit	
Plate Supply Voltage	550	550	volts
Plate Voltage	300	300	volts
Grid-No.2 (Screen-Grid) Supply Voltage	—	550	volts
Grid-No.2 Voltage	—	300	volts
Grid-No.1 (Control-Grid) Voltage, Negative-bias value	1.3	1.3	volts
Cathode Current	4	55	mA
Plate Dissipation	0.5	9	watts
Grid-No.2 Input	—	1.5	watts

CHARACTERISTICS

Plate Voltage	250	250	volts
Grid-No.2 Voltage	—	250	volts
Grid-No.1 Voltage	-1.9	-7	volts
Amplification Factor	100	21*	
Plate Resistance (Approx.)	—	45000	ohms
Transconductance	1600	10000	μmhos
Plate Current	1.2	36	mA
Grid-No.2 Current	—	6	mA

MAXIMUM CIRCUIT VALUES

Grid-No.1-Circuit Resistance, for fixed-bias operation	1	0.5	megohm
--------------------------------------------------------	---	-----	--------

* Grid No.2 to grid No.1.

Refer to chart at end of section.
For replacement use type 6GY6/6GX6.

6GX6

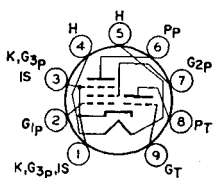

9QA

MEDIUM-MU TRIODE— SHARP-CUTOFF PENTODE

Miniature type used as combined oscillator-mixer tube in vhf tuner circuits of color and black-and-white television receivers. Outlines section, 6B; requires miniature 9-contact socket.

6GX7

Heater Voltage (ac/dc)	6.3	volts
Heater Current	0.4	ampere
Heater-Cathode Voltage:		
Peak value	±200 max	volts
Average value	100 max	volts
Direct Interelectrode Capacitances:**		
Triode Unit:		
Grid to Plate	1.2	pF
Grid to Cathode, Heater, Pentode Cathode, Grid No.3, and Internal Shield	2.3	pF
Plate to Cathode, Heater, Pentode Cathode, Grid No.3, and Internal Shield	1.9	pF
Pentode Unit:		
Grid No.1 to Plate	0.005	pF
Grid No.1 to Cathode, Heater, Grid No.2, Grid No.3, and Internal Shield	5.4	pF
Plate to Cathode, Heater, Grid No.2, Grid No.3, and Internal Shield	3.3	pF
Grid No.1 to Grid No.2	1.6	pF

** With external shield connected to cathode.

Class A₁ Amplifier

MAXIMUM RATINGS (Design-Maximum Values)	Triode Unit	Pentode Unit	
Plate Voltage	275	275	volts
Grid-No.2 (Screen-Grid) Supply Voltage	—	275	volts
Grid-No.2 Voltage	—	See curve page 300	
Grid-No.1 (Control-Grid) Voltage:			
Positive-bias value	0	0	
Negative-bias value	40	40	volts
Cathode Current	20	20	mA
Plate Dissipation	1.5	2.2	watts
Grid-No.2 Input:			
For grid-No.2 voltages up to 137.5 volts	—	0.45	watts
For grid-No.2 voltages between 137.5 and 275 volts	—	See curve page 300	

CHARACTERISTICS

	Triode Unit	Pentode Unit	
Plate Voltage	100	125	125
Grid-No.2 Voltage	—	—	90
Grid-No.1 Voltage	—	—1	—1
Grid-No.1-Circuit Resistance	0.1	—	0.1
Amplification Factor	40	—	—
Plate Resistance	—	4700	—
Transconductance	8700	8500	13000
Plate Current	12.5	13	8.5
Grid-No.2 Current	—	—	2.8
Grid-No.1 Voltage for plate current of 20 μ A	—6	—	—2.5

MAXIMUM CIRCUIT VALUES

	Triode Unit	Pentode Unit	
Grid-No.1-Circuit Resistance:			
For fixed-bias operation	0.5	0.25	megohm
For cathode-bias operation	1	0.5	megohm

6GY5

16GY5, 21GY5

BEAM POWER TUBE

Duodecar type used as horizontal-deflection amplifier in television receivers. Outlines section, 39A; requires duodecar 12-contact socket. Types 16GY5 and 21GY5 are identical with type 6GY5 except for heater ratings.

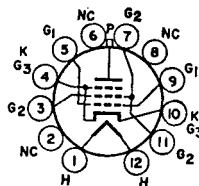

12DR

	6GY5	16GY5	21GY5	
Heater Voltage (ac/dc)	6.3	15.8	21	volts
Heater Current	1.5	0.6	0.45	amperes
Heater Warm-up Time (Average)	—	11	11	seconds
Heater-Cathode Voltage:				
Peak value	± 200 max	± 200 max	± 200 max	volts
Average value	100 max	100 max	100 max	volts

Class A₁ Amplifier

CHARACTERISTICS

	Pentode Connection			Triode† Connection	
Plate Voltage	5000	60	130	130	volts
Grid-No.2 (Screen-Grid) Voltage	130	130	130	130	volts
Grid-No.1 (Control-Grid) Voltage	—	0	—20	—20	volts
Amplification Factor	—	—	—	4.7	
Plate Resistance (Approx.)	—	—	11000	—	ohms
Transconductance	—	—	9100	—	μ mhos
Plate Current	—	410**	50	—	mA
Grid-No.2 Current	—	24**	1.75	—	mA
Grid-No.1 Voltage (Approx.) for plate current of 1 μ A	—66	—	—33	—	volts

** This value can be measured by a method involving a recurrent waveform such that the maximum ratings of the tube will not be exceeded.

† Grid No.2 tied to plate.

Horizontal-Deflection Amplifier

For operation in a 525-line, 30-frame system

MAXIMUM RATINGS (Design-Maximum Values)

DC Plate Supply Voltage	770	volts
Peak Positive-Pulse Plate Voltage#	6500	volts

Peak Negative-Pulse Plate Voltage	1500	volts
DC Grid-No.2 Voltage	220	volts
DC Grid-No.1 Voltage	-55	volts
Peak Negative-Pulse Grid-No.1 Voltage	330	volts
Peak Cathode Current	800	mA
Average Cathode Current	230	mA
Plate Dissipation††	18	watts
Grid-No.2 Input	3.5	watts
Bulb Temperature (At hottest point)	220	°C

MAXIMUM CIRCUIT VALUE

Grid-No.1-Circuit Resistance	1	megohm
------------------------------	---	--------

Pulse duration must not exceed 15% of a horizontal scanning cycle (10 microseconds).

†† A bias resistor or other means is required to protect the tube in absence of excitation.

6GY6
6GY6/
6GX6

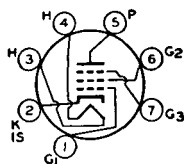

SHARP-CUTOFF PENTODE

Miniature type used in gated-agc-amplifier circuits and as a noise-inverter tube in color and black-and-white television receivers. Tube has two independent control grids. Outlines section, 5C; requires miniature 7-contact socket.

7EN

Heater Voltage (ac/dc)	6.3	volts
Heater Current	0.45	ampere
Heater Warm-up Time (Average)	11	seconds
Heater-Cathode Voltage:		
Peak value	±200 max	volts
Average value	100 max	volts
Direct Interelectrode Capacitances:		
Grid No.1 to Plate	0.026	pF
Grid No.1 to Cathode, Heater, Grid No.2, Grid No.3, and Internal Shield	8	pF
Grid No.1 to Grid No.3	0.12	pF
Grid No.3 to Plate	1.6	pF
Grid No.3 to Cathode, Heater, Plate, Grid No.1, Grid No.2, and Internal Shield	6.5	pF

Class A₁ Amplifier

CHARACTERISTICS

Plate Supply Voltage	150	volts
Grid-No.3 Supply Voltage	0	volts
Grid-No.2 Supply Voltage	100	volts
Grid-No.1 Supply Voltage	0	volts
Cathode-Bias Resistor	180	ohms
Plate Resistance (Approx.)	0.14	megohm
Transconductance, Grid No.1 to Plate	3700	μmhos
Transconductance, Grid No.3 to Plate	750	μmhos
Plate Current	3.7	mA
Grid-No.2 Current	3	mA
Grid-No.3 Supply Voltage (Approx.) for plate current of 20 μA	-7	volts
Grid-No.1 Supply Voltage (Approx.) for plate current of 20 μA	-4.5	volts

Gated AGC Amplifier and Noise Inverter

For operation in a 525-line, 30-frame system

MAXIMUM RATINGS (Design-Maximum Values)

Plate Voltage	300	volts
Peak Positive-Pulse Plate Voltage#	600	volts
Grid-No.3 (Control-Grid) Voltage:		
Negative-bias value	100	volts
Positive-bias value	0	volts
Grid-No.2 (Screen-Grid) Supply Voltage	300	volts
Grid-No.2 Voltage	See curve page 300	
Grid-No.1 (Control-Grid) Voltage:		
Negative-bias value	50	volts
Positive-bias value	0	volts
Plate Dissipation	1.7	watts
Grid-No.2 Input:		
For grid-No.2 voltages up to 150 volts	1	watt
For grid-No.2 voltages between 150 and 300 volts	See curve page 300	

Screen-Grid (Grid-No. 2) Input Rating Chart

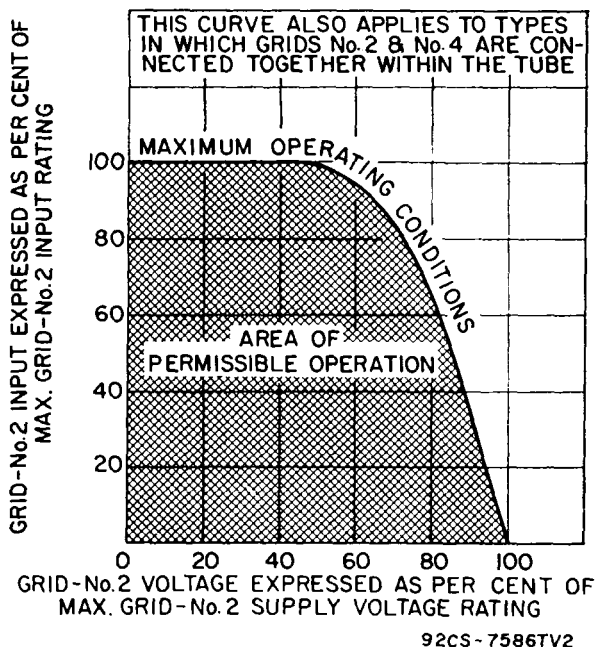

Fig. 134—Grid-No.2 input rating curve.

For certain voltage amplifier types, as listed in the data section, the maximum permissible screen-grid (grid-No. 2) input varies with the screen-grid voltage, as shown in the chart above. (This chart cannot be assumed to apply to types other than those for which it is specified in the data section.) Full rated screen-grid input is permissible at screen-grid voltages up to 50 per cent of the maximum rated screen-grid supply voltage. From the 50-per-cent point to the full rated value of supply voltage, the screen-grid input must be decreased. The decrease in allowable screen-grid input follows a curve of the parabolic form. This rating chart is useful for applications utilizing either a fixed screen-grid voltage or a series screen-grid voltage-dropping resistor.

When a fixed voltage is used, it is necessary only to determine that the screen-grid input is within the boundary of the operating area on the chart at the selected value of screen-grid voltage to be used. When a voltage-dropping resistor is used, the minimum value of resistor that will assure tube operation within the boundary of the curve can be determined from the following relation:

$$R_{g2} \cong \frac{E_{c2} (E_{c2} - E_{c2})}{P_{c2}}$$

where R_{g2} is the minimum value for the voltage-dropping resistor in ohms, E_{c2} is the selected screen-grid voltage in volts, E_{c2} is the screen-grid supply voltage in volts, and P_{c2} is the screen-grid input in watts corresponding to E_{c2} .

MAXIMUM CIRCUIT VALUES

Grid-No.3-Circuit Resistance	0.68	megohm
Grid-No.1-Circuit Resistance:		
For fixed-bias operation	0.22	megohm
For cathode-bias operation	0.47	megohm

Pulse duration must not exceed 15% of a horizontal scanning cycle (10 microseconds).

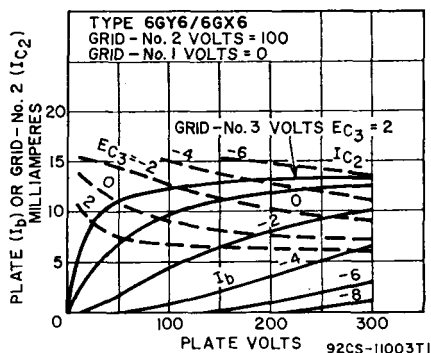
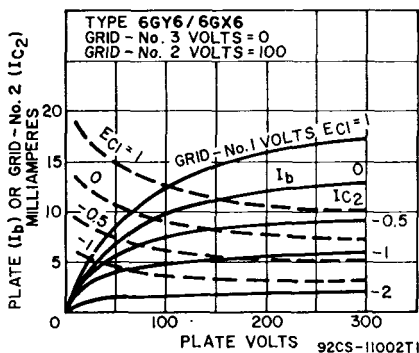

Refer to chart at end of section.

6GY8

Refer to chart at end of section.

6GZ5

Refer to chart at end of section.

6H6

Refer to chart at end of section.

6H6GT

For replacement use type 6HM5/6HA5.

6HA5

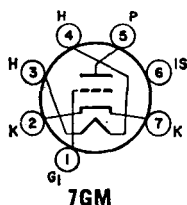

HIGH-MU TRIODE

6HA5-S

Miniature type used as rf-amplifier tube in vhf television tuners. Outlines section, 5B; requires miniature 7-contact socket. Type 6HA5-S is electrically identical with type 6HM5/6HA5.

For replacement use type 6HB6/6HA6.

6HA6

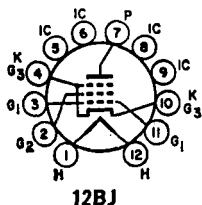

BEAM POWER TUBE

6HB5

Duodecar type used as horizontal-deflection amplifier in television receivers. Outlines section, 15B; requires duodecar 12-contact socket.

Heater Voltage (ac/dc)	6.3	volts
Heater Current	1.5	amperes
Heater-Cathode Voltage:		
Peak value	±200 max	volts
Average value	100 max	volts

Class A₁ Amplifier

CHARACTERISTICS	Pentode Connection			Triode* Connection	
Plate Voltage	5000	60	130	130	volts
Grid-No.2 (Screen-Grid) Voltage	130	130	130	130	volts
Grid-No.1 (Control-Grid) Voltage	—	0	-20	-20	volts
Amplification Factor	—	—	—	4.7	
Plate Resistance (Approx.)	—	—	11000	—	ohms
Transconductance	—	—	9100	—	μmhos
Plate Current	—	410*	60	—	mA
Grid-No.2 Current	—	24*	1.75	—	mA
Grid-No.1 Voltage (Approx.) for plate current of 1 mA	-66	—	-33	—	volts

* Grid No.2 tied to plate.

† This value can be measured by a method involving a recurrent waveform such that the maximum ratings of the tube will not be exceeded.

Horizontal-Deflection Amplifier

For operation in a 525-line, 30-frame system

MAXIMUM RATINGS (Design-Maximum Values)

DC Plate Supply Voltage	770	volts
Peak Positive-Pulse Plate Voltage#	6000	volts
Peak Negative-Pulse Plate Voltage	1500	volts
DC Grid-No.2 Voltage	220	volts
DC Grid-No.1 Voltage	-55	volts
Peak Negative-Pulse Grid-No.1 Voltage	330	volts
Peak Cathode Current	800	mA
Average Cathode Current	230	mA
Plate Dissipation†	18	watts
Grid-No.2 Input	3.5	watts
Bulb Temperature (At hottest point)	220	°C

MAXIMUM CIRCUIT VALUE

Grid-No.1-Circuit Resistance	1	megohm
------------------------------	---	--------

Pulse duration must not exceed 15% of a horizontal scanning cycle (10 microseconds).

† A bias resistor or other means is required to protect the tube in absence of excitation.

**6HB6
6HB6/6HA6**

Refer to chart at end of section.

**6HB7
5HB7**

**MEDIUM-MU TRIODE—
SHARP-CUTOFF PENTODE**

Miniature type used as combined oscillator and mixer tube in color and black-and-white television receivers utilizing an intermediate frequency in the order of 40 MHz. Outlines section, 6B; requires miniature 9-contact socket. Type 5HB7 is identical with type 6HB7 except for heater ratings.

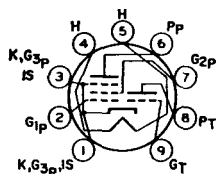

9QA

	5HB7	6HB7	
Heater Voltage (ac/dc)	4.7	6.3	volts
Heater Current	0.6	0.45	ampere
Heater Warm-up Time (Average)	11	11	seconds
Heater-Cathode Voltage:			
Peak value	±200 max	±200 max	volts
Average value	100 max	100 max	volts
Direct Interelectrode Capacitances:			
Triode Unit:			
Grid to Plate		1.9	pF
Grid to Cathode, Heater, Pentode Grid No.3, and Internal Shield		3	pF
Plate to Cathode, Heater, Pentode Grid No.3, and Internal Shield		1.9	pF
Pentode Unit:			
Grid No.1 to Plate		0.010 max	pF
Grid No.1 to Cathode, Heater, Grid No.2, Grid No.3, and Internal Shield		5	pF
Plate to Cathode, Heater, Grid No.2, Grid No.3, and Internal Shield		3.4	pF
Heater to Cathode*		3.8	pF

▲ With external shield connected to cathode except as noted.

* With external shield connected to ground.

Class A₁ Amplifier

MAXIMUM RATINGS (Design-Maximum Values)

Plate Voltage	330
Grid-No.2 (Screen-Grid) Supply Voltage	—
Grid-No.2 Voltage	—
Grid-No.1 (Control-Grid) Voltage:	
Positive-bias value	0
Plate Dissipation	2.5
Grid-No.2 Input:	
For grid-No.2 voltages up to 165 volts	—
For grid-No.2 voltages between 165 and 330 volts	—

Triode Unit Pentode Unit

330	330	volts
—	330	volts
—	See curve	page 300
0	0	volts
2.5	3.1	watts
—	0.55	watt
—	See curve	page 300

CHARACTERISTICS

Plate Supply Voltage	150
Grid-No.2 Supply Voltage	—
Grid-No.1 Supply Voltage	0
Cathode-Bias Resistor	56
Amplification Factor	40
Plate Resistance (Approx.)	0.005
Transconductance	8500
Plate Current	18
Grid-No.2 Current	—
Grid-No.1 Voltage (Approx.) for plate current of 10 μ A	-12

125	125	volts
—	125	volts
—	-1	volts
—	—	ohms
—	—	—
0.2	0.2	megohm
6400	6400	μ mhos
4	4	mA
—	4	mA
—	-9	volts

MAXIMUM CIRCUIT VALUES

Grid-No.1-Circuit Resistance:	
For fixed-bias operation	0.5
For cathode-bias operation	1

0.25	megohm
0.5	megohm

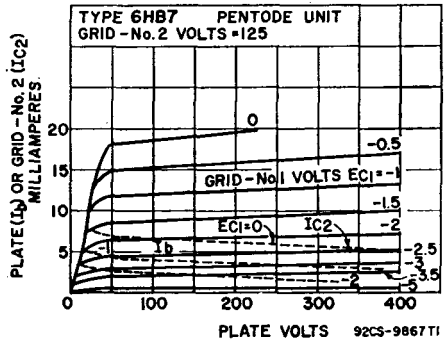
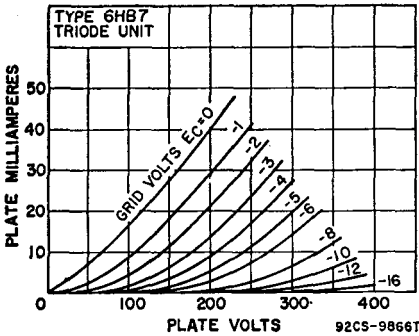

Refer to chart at end of section.

6HD7

Refer to chart at end of section.
For replacement use type 6JB5/6HE5.

6HE5

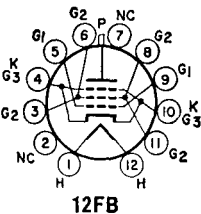

BEAM POWER TUBE

6HF5

Duodecar type used as horizontal-deflection amplifier in color and black-and-white television receivers. Out-lines section, 16B; requires duodecar 12-contact socket. Heater: volts (ac/dc), 6.3; amperes, 2.25; maximum heater-cathode volts, ± 200 peak, 100 average.

Class A₁ Amplifier

CHARACTERISTICS	Pentode Connection			Triode* Connection	
	Plate Voltage	5000	70	175	125
Grid-No.2 (Screen-Grid) Voltage	125	125	125	125	volts
Grid-No.1 (Control-Grid) Voltage	—	0	-25	-25	volts
Amplification Factor	—	—	—	3	
Plate Resistance (Approx.)	—	—	5600	—	ohms
Transconductance	—	—	11300	—	μmhos
Plate Current	—	570*	125	—	mA
Grid-No.2 Current	—	34*	4.5	—	mA
Grid-No.1 Voltage (Approx.) for plate current of 1 mA	-140	—	-54	—	volts

* Grid No.2 tied to plate.

† This value can be measured by a method involving a recurrent waveform such that the maximum ratings of the tube will not be exceeded.

Horizontal-Deflection Amplifier

For operation in a 525-line, 30-frame system

MAXIMUM RATINGS (Design-Maximum Values)

DC Plate Supply Voltage	900	volts
Peak Positive-Pulse Plate Voltage# (Absolute Maximum)	7500 [†]	volts
Peak Negative-Pulse Plate Voltage	1100	volts
DC Grid-No.2 Voltage	190	volts
Peak Negative-Pulse Grid-No.1 Voltage	250	volts
Peak Cathode Current	1100	mA
Average Cathode Current	315	mA
Plate Dissipation†	28	watts
Grid-No.2 Input	5.5	watts
Bulb Temperature (At hottest point)	225	°C

MAXIMUM CIRCUIT VALUE

Grid-No.1-Circuit Resistance 1 megohm

Pulse duration must not exceed 15% of a horizontal scanning cycle (10 microseconds).

† Under no circumstances should this absolute value be exceeded.

‡ A bias resistor or other means is required to protect the tube in absence of excitation.

6HF8
10HF8

**HIGH-MU TRIODE—
SHARP-CUTOFF PENTODE**

Miniature type used in color and black-and-white television receiver applications. The triode unit is used in high-gain, sound-if stages and in sync-separator, sync-clipper, and phase-inverter circuits; the pentode unit is used as a video-output amplifier. Outlines section, 6E; requires miniature 9-contact socket. For curves of average characteristics, refer to type 6AW8A for the triode unit and to type 6EB8 for the pentode unit. Type 10HF8 is identical with type 6HF8 except for heater ratings.

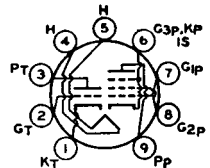

9DX

	6HF8	10HF8	
Heater Voltage (ac/dc)	6.3	10.5	volts
Heater Current	0.75	0.45	ampere
Heater Warm-up Time (Average)	—	11	seconds
Heater-Cathode Voltage:			
Peak value	±200 max	±200 max	volts
Average value	100 max	100 max	volts
Direct Interelectrode Capacitances:			
Triode Unit:			
Grid to Plate		3.5	pF
Grid to Cathode, Heater, Pentode Cathode, Grid No.3, and Internal Shield		2.8	pF
Plate to Cathode, Heater, Pentode Cathode, Grid No.3, and Internal Shield		2.6	pF
Pentode Unit:			
Grid No.1 to Plate		0.1 max	pF
Grid No.1 to Cathode, Heater, Grid No.2, Grid No.3, and Internal Shield		10	pF
Plate to Cathode, Heater, Grid No.2, Grid No.3, and Internal Shield		4.2	pF
Triode Grid to Pentode Plate		0.015 max	pF

Class A₁ Amplifier

MAXIMUM RATINGS (Design-Maximum Values)

	Triode Unit	Pentode Unit	
Plate Voltage	330	330	volts
Grid-No.2 (Screen-Grid) Supply Voltage	—	330	volts
Grid-No.2 Voltage	—	See curve page 300	
Grid-No.1 (Control-Grid) Voltage, Positive-bias value	0	0	volts
Plate Dissipation	1	5	watts
Grid-No.2 Input:			
For grid-No.2 voltages up to 165 volts	—	1.1	watts
For grid-No.2 voltages between 165 and 330 volts	—	See curve page 300	

CHARACTERISTICS

	Triode Unit	Pentode Unit		
Plate Supply Voltage	200	45	200	volts
Grid-No.2 Supply Voltage	—	125	125	volts
Grid-No.1 Voltage	-2	0	—	volts
Cathode-Bias Resistor	—	—	68	ohms
Amplification Factor	70	—	—	
Plate Resistance (Approx.)	17500	—	75000	ohms
Transconductance	4000	—	12500	μmhos
Plate Current	4	40*	25	mA
Grid-No.2 Current	—	15*	7	mA
Grid-No.1 Voltage (Approx.) for plate current of 100 μA	—	—	-9	volts
Grid-No.1 Voltage (Approx.) for plate current of 20 μA	-6	—	—	volts

MAXIMUM CIRCUIT VALUES

	Triode Unit	Pentode Unit	
Grid-No.1-Circuit Resistance:			
For fixed-bias operation	0.5	0.25	megohm
For cathode-bias operation	1	1	megohm

* This value can be measured by a method involving a recurrent waveform such that the maximum ratings of the tube will not be exceeded.

Refer to chart at end of section.

6HG5

Refer to chart at end of section.

6HG8

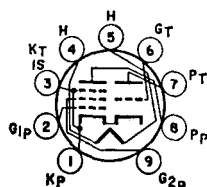

9MP

MEDIUM-MU TRIODE—
SHARP-CUTOFF PENTODE

6HG8/
ECF86

5HG8/LCF86
7HG8/PCF86

Miniature type with frame-grid pentode unit used as combined oscillator and mixer tubes in vhf color and black-and-white television receivers. Outlines section, 6B; requires miniature 9-contact socket. Types 5HG8/LCF86 and 7HG8/PCF86 are identical with type 6HG8/ECF86 except for heater ratings.

	5HG8/ LCF86	6HG8/ ECF86	7HG8/ PCF86	
Heater Voltage (ac/dc)	5.3	6.3	7.2	volts
Heater Current	0.45	0.34	0.3	ampere
Heater Warm-up Time (Average)	11	—	—	seconds
Peak Heater-Cathode Voltage	±100 max	±100 max	±100 max	volts

Class A₁ Amplifier

MAXIMUM RATINGS (Design-Maximum Values)

	Triode Unit	Pentode Unit	
Plate Voltage	125	250	volts
Grid-No.2 (Screen-Grid) Voltage	—	150	volts
Cathode Current	15	18	mA
Plate Dissipation	1.5	2	watts
Grid-No.2 Input	—	0.5	watt

CHARACTERISTICS

	Triode Unit	Pentode Unit	
Plate Voltage	100	170	volts
Grid-No.2 Voltage	—	150	volts
Grid-No.1 (Control-Grid) Voltage	-3	-1.2	volts
Amplification Factor	17	—	

Mu-Factor, Grid No.2 to Grid No.1	—	70	
Plate Resistance (Approx.)	—	0.35	megohm
Transconductance	5500	12000	μ mhos
Plate Current	14	10	mA
Grid-No.2 Current	—	3.3	mA

MAXIMUM CIRCUIT VALUES

Grid-No.1-Circuit Resistance:			
For fixed-bias operation	—	0.25	megohm
For cathode-bias operation	0.5	0.5	megohm

6HJ5 Refer to chart at end of section.

6HJ8 Refer to chart at end of section.

6HK5 Refer to chart at end of section.

6HL8 MEDIUM-MU TRIODE— SHARP-CUTOFF PENTODE

Miniature type used in color and black-and-white television receiver applications. The triode unit is used as a sync-separator or voltage-amplifier tube, and the pentode unit is used as a video if-amplifier, agc-amplifier, or reactance tube. Outlines section, 6B; requires miniature 9-contact socket. Heater: volts (ac/dc), 6.3; amperes, 0.6; warm-up time (average), 11 seconds; maximum heater-cathode volts, ± 200 peak, 100 average.

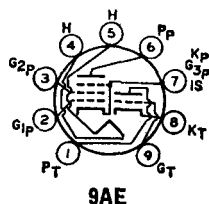
**Class A₁ Amplifier****MAXIMUM RATINGS (Design-Maximum Values)**

	Triode Unit	Pentode Unit	
Plate Voltage	330	330	volts
Grid-No.2 (Screen-Grid) Supply Voltage	—	330	volts
Grid-No.2 Voltage	—	See curve page 300	
Grid-No.1 (Control-Grid) Voltage, Positive-bias value	0	0	volts
Plate Dissipation	2.5	2.5	watts
Grid-No.2 Input:			
For grid-No.2 voltages up to 165 volts	—	0.55	watt
For grid-No.2 voltages between 165 and 330 volts	—	See curve page 300	

CHARACTERISTICS

Plate Voltage	125	125	volts
Grid-No.2 Voltage	—	125	volts
Grid-No.1 Voltage	-1	-1	volt
Amplification Factor	40	—	
Plate Resistance (Approx.)	5000	150000	ohms
Transconductance	7000	10000	μ mhos
Plate Current	12.5	12	mA
Grid-No.2 Current	—	4.5	mA
Grid-No.1 Voltage (Approx.) for plate current of 20 μ A	—	-7	volts

MAXIMUM CIRCUIT VALUE

Grid-No.1-Circuit Resistance	1	—	megohm
------------------------------------	---	---	--------

6HM5 For replacement use type 6HM5/6HA5.

6HM5/ 6HA5

2HM5/2HA5
3HM5/3HA5
4HM5/4HA5

HIGH-MU TRIODE

Miniature type used as rf-amplifier tube in vhf color and black-and-white television tuners. Outlines section, 5C; requires miniature 7-contact socket. Types 2HM5/2HA5, 3HM5/3HA5, and 4HM5/4HA5 are identical with type 6HM5/6HA5 except for heater ratings.

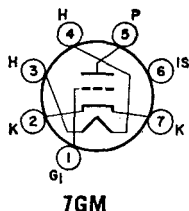

	2HM5/ 2HA5	3HM5/ 3HA5	4HM5/ 4HA5	6HM5/ 6HA5	
Heater Voltage (ac/dc)	2.0	2.7	4.0	6.3	volts
Heater Current	0.6	0.45	0.3	0.18	ampere
Peak Heater-Cathode Voltage	±110 max	±110 max	±110 max	±110 max	volts
Direct Interelectrode Capacitances:					
Grid to Plate				0.36	pF
Grid to Cathode, Heater, Internal Shield, and External Shield				4.3	pF
Plate to Cathode, Heater, Internal Shield, and External Shield				0.80	pF
Cathode to Plate				2.9	pF
Cathode to Heater, Grid, Internal Shield, and External Shield				3.1	pF
Heater to Cathode				2.3	pF
Heater to Grid				0.070 max	pF

Class A₁ Amplifier

MAXIMUM RATINGS (Design-Maximum Values)

DC Plate Voltage	220	volts
DC Plate Supply Voltage	600	volts
Grid Voltage	-50	volts
Cathode Current	22	mA
Plate Dissipation	2.6	watts

CHARACTERISTICS AND TYPICAL OPERATION

	Fixed Bias		Cathode Bias		
DC Plate Supply Voltage	135	135	135	135	volts
Plate-Load Resistor	—	—	1000	5600	ohms
Internal-Shield Voltage	0	0	0	0	volts
DC Grid Voltage	-1	-2.7	—	—	volts
Cathode-Bias Resistor	—	—	0	87	ohms
Amplification Factor	72	—	80	72	
Transconductance	14500	1500	20000	14500	μmhos
Plate Current	11.5	—	19	11.5	mA
DC Grid Current	—	—	10	—	μA
Grid-No.1 Voltage for one-per-cent transconductance	—	—	-5.3	-8.1	volts

Refer to chart at end of section.

6HM6

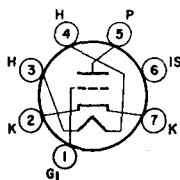

7GM

HIGH-MU TRIODE

6HQ5

2HQ5, 3HQ5, 4HQ5

Miniature type used as grounded-cathode rf-amplifier tube in vhf tuners of television receivers. Outlines section, 5C; requires miniature 7-contact socket. Types 2HQ5, 3HQ5, and 4HQ5 are identical with type 6HQ5 except for heater ratings.

	2HQ5	3HQ5	4HQ5	6HQ5	
Heater Voltage (ac/dc)	2.4	3	4.2	6.3	volts
Heater Current	0.6	0.45	0.3	0.2	ampere
Heater Warm-up Time (Average)	11	11	11	—	seconds
Peak Heater-Cathode Voltage	±100 max	±100 max	±100 max	±100 max	volts
Direct Interelectrode Capacitances (Approx.):*					
Grid to Plate				0.52	pF
Grid to Cathode, Heater, and Internal Shield				5	pF
Plate to Cathode, Heater, and Internal Shield				3.5	pF
Heater to Cathode				2.5	pF

* With external shield connected to cathode.

Class A₁ Amplifier

MAXIMUM RATINGS (Design-Maximum Values)

Plate Voltage	200	volts
Grid Voltage, Negative-bias Value	50	volts
Cathode Current	22	mA
Plate Dissipation	2.5	watts

CHARACTERISTICS

Plate Voltage	135	volts
Grid Voltage	-1	volt
Amplification Factor	78	
Plate Resistance	5400	ohms
Transconductance	15000	μ mhos
Plate Current	11.5	mA
Input Resistance**	275	ohms
Input Capacitance**	11.2	pF
Noise Figure#	4.7	dB
Grid Voltage (Approx.) for transconductance of 150 μ mhos	-4.2	volts
Grid Voltage (Approx.) for transconductance of 1500 μ mhos	-2.5	volts

MAXIMUM CIRCUIT VALUE

Grid-Circuit Resistance, for cathode-bias operation 1 megohm

** Measured at 200 MHz with heater volts = 6.3 volts and plate effectively grounded for rf voltages.

For a neutralized triode amplifier at a frequency of 200 MHz with signal source impedance adjusted for minimum noise output.

6HR5

Refer to chart at end of section.

6HR6

Refer to chart at end of section.

6HS5**BEAM TRIODE**

Duodecar type used as a pulse-type regulator in the high-voltage power supply of color television receivers. Outlines section, 15F; requires duodecar 12-contact socket. Heater: volts (ac/dc), 6.3; amperes, 1.5.

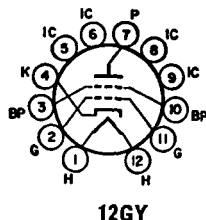
**Class A₁ Amplifier****CHARACTERISTICS**

Pulse Plate Voltage*	3500	volts
Grid No.2 (Beam Plate)	Connected to cathode at socket	
Grid-Voltage, Negative-bias value	4.4	volts
Peak Plate Current	300	mA
Amplification Factor	300	
Transconductance	65000	μ mhos
Plate Resistance (Approx.)	4600	ohms
Grid Voltage (Approx.) for plate current of 1 mA	-13	volts

* Duty cycle of the pulse must be less than 2.5%.

High-Voltage Regulator Service

For operation in a 525-line, 30-frame system

MAXIMUM RATINGS (Design-Maximum Values)

Peak Plate Voltage#	5500	volts
Plate Dissipation	30	watts
Peak Plate Current	325	mA
Heater-Cathode Voltage:		
Peak value	+200 -450	volts
Average value	100	volts
Bulb Temperature (At hottest point)	220	$^{\circ}$ C

MAXIMUM CIRCUIT VALUE

Grid-Circuit Resistance^A 0.1 megohm

Pulse duration must not exceed 15% of a horizontal scanning cycle (10 microseconds).

^A Larger values of grid-circuit resistance may be used if provisions are made to protect the tube.

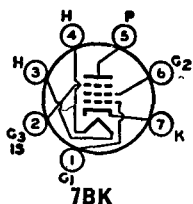

SHARP-CUTOFF PENTODE

6HS6

Miniature type used as if-amplifier and limiter tube in FM receivers. Outlines section, 5C; requires miniature 7-contact socket.

Heater Voltage (ac/dc)	6.3	volts
Heater Current	0.45	ampere
Heater Warm-up Time (Average)	11	seconds
Heater-Cathode Voltage:		
Peak value	±200 max	volts
Average value	100 max	volts
Direct Interelectrode Capacitances:		
Grid No.1 to Plate	0.006 max	volts
Grid No.1 to Cathode, Heater, Grid No.2, Grid No.3, and Internal Shield	8.8	pF
Plate to Cathode, Heater, Grid No.2, Grid No.3, and Internal Shield	5.2	pF

Class A₁ Amplifier

MAXIMUM RATINGS (Design-Maximum Values)

Plate Supply Voltage	300	volts
Grid-No.3 (Suppressor-Grid) Voltage, Positive Value	0	volts
Grid-No.2 (Screen-Grid) Supply Voltage	300	volts
Grid-No.2 Voltage	See curve page 300	
Grid-No.1 (Control-Grid) Voltage:		
Negative-bias value	50	volts
Positive-bias value	0	volts
Plate Dissipation	3	watts
Grid-No.2 Input:		
For grid-No.2 voltages up to 150 volts	1	watt
For grid-No.2 voltages between 150 and 300 volts	See curve page 300	

CHARACTERISTICS

Plate Supply Voltage	75	150	volts
Grid No.3	Connected to cathode at socket		
Grid-No.2 Supply Voltage	75	75	volts
Grid-No.1 Supply Voltage	0	0	volts
Cathode-Bias Resistor	68	68	ohms
Amplification Factor*	50	—	
Plate Resistance (Approx.)	—	0.5	megohm
Transconductance	—	9500	μmhos
Plate Current	—	8.8	mA
Grid-No.2 Current	—	2.8	mA
Grid-No.1 Voltage (Approx.) for plate current of 20 μA	—	-4	volts

MAXIMUM CIRCUIT VALUES

Grid-No.1-Circuit Resistance:		
For fixed-bias operation	0.5	megohm
For cathode-bias operation	1	megohm

* Grid No.2 connected to plate.

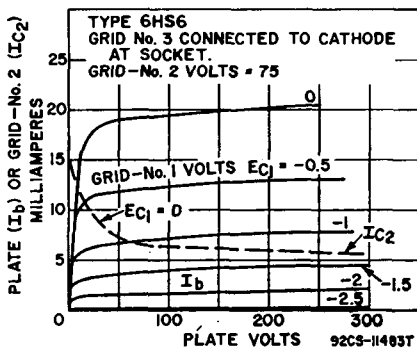

6HS83HS8
4HS8**SHARP-CUTOFF
TWIN PENTODE**

Miniature type used in agc amplifier, sync, and noise-limiting circuits of color and black-and-white television receivers. One pentode unit is used as combined sync separator and sync clipper; second pentode unit is used as agc amplifier. **Outlines section, 6E**; requires miniature 9-contact socket. Types 3HS8 and 4HS8 are identical with type 6HS8 except for heater ratings.

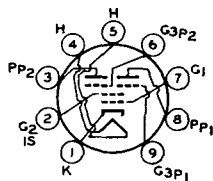
**9FG**

	3HS8	4HS8	6HS8	
Heater Voltage (ac/dc)	3.5	4.2	6.3	volts
Heater Current	0.6	0.45	0.3	ampere
Heater Warm-up Time (Average)	11	11	—	seconds
Heater-Cathode Voltage:				
Peak value		±200 max	±200 max	volts
Average value		100 max	100 max	volts
Direct Interelectrode Capacitances:				
Grid No.3 to Plate (Each Unit)			2	pF
Grid No.1 to All Other Electrodes			6	pF
Grid No.3 (Each Unit) to All Other Electrodes			3.6	pF
Plate (Each Unit) to All Other Electrodes			3	pF
Grid No.3 (Unit No.1) to Grid No.3 (Unit No.2)			0.015 max	pF

Class A₁ Amplifier**MAXIMUM RATINGS (Design-Maximum Values)**

Plate Voltage (Each Unit)	300	volts
Grid-No.3 (Suppressor-Grid) Voltage (Each Unit):		
Peak positive value	50	volts
DC negative value	50	volts
DC positive value	3	volts
Grid-No.2 (Screen-Grid) Voltage	150	volts
Grid-No.1 (Control-Grid) Voltage, Negative-bias value	50	volts
Cathode Current	12	mA
Plate Dissipation (Each Unit)	1.1	watts
Grid-No.2 Input	0.75	watt

CHARACTERISTICS**With One Unit Operating***

Plate Voltage	100	100	volts
Grid-No.3 Voltage	0	0	volts
Grid-No.2 Voltage	67.5	67.5	volts
Grid-No.1 Voltage	0	0	volts
Transconductance, Grid No.3 to Plate	—	450	μmhos
Transconductance, Grid No.1 to Plate	1100	—	μmhos
Plate Current	—	2	mA
Grid-No.3 Voltage (Approx.) for plate current of 100 μA	—	-3.5	volts
Grid-No.1 Voltage (Approx.) for plate current of 100 μA	—	-2.3	volts

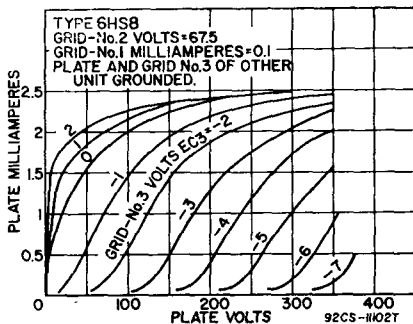
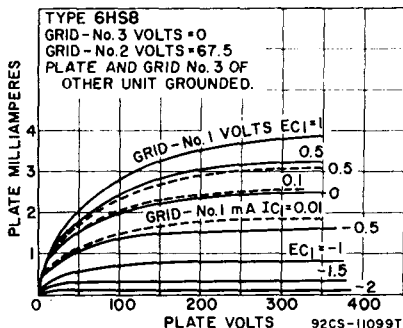

With Both Units Operating

Plate Voltage (Each Unit)	100	100	volts
Grid-No.3 Voltage (Each Unit)	-10	0	volts
Grid-No.2 Voltage	67.5	67.5	volts
Grid-No.1 Voltage	"	"	volts
Plate Current (Each Unit)	—	2	mA
Grid-No.2 Current	7	4.4	mA
Cathode Current	7.1	8.5	mA

MAXIMUM CIRCUIT VALUES

Grid-No.3-Circuit Resistance (Each Unit)	0.5	megohm
Grid-No.1-Circuit Resistance	0.5	megohm

* With plate and grid No.3 of other unit connected to ground.

* Adjusted to give grid-No.1 current of 0.1 milliampere.

Refer to chart at end of section.

6HU6/EM87

Refer to chart at end of section.

6HU8/ELL80

Refer to chart at end of section.

6HV5

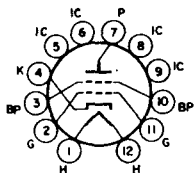

12GY

BEAM TRIODE

6HV5A

Duodecar type used as a pulse-type regulator in the high-voltage power supply of color television receivers. Outlines section, 15F; requires duodecar 12-contact socket. Heater: volts (ac/dc), 6.3; amperes, 1.8.

Class A₁ Amplifier

CHARACTERISTICS

Pulse Plate Voltage*	3500	volts
Grid No.2 (Beam Plate)	Connected to cathode at socket	
Grid-Voltage, Negative-bias value	4.4	volts
Peak Plate Current	300	mA
Amplification Factor	300	
Transconductance	65000	μmhos
Plate Resistance (Approx.)	4600	ohms
Grid Voltage (Approx.) for plate current of 1 mA	-13	volts

* Duty cycle of the pulse must be less than 2.5%.

High-Voltage Regulator Service

For operation in a 525-line, 30-frame system

MAXIMUM RATINGS (Design-Maximum Values)

Peak Plate Voltage#	5500	volts	
Plate Dissipation	35	watts	
Peak Plate Current	325	mA	
Heater-Cathode Voltage:			
Peak value	+200	-450	volts
Average value		100	volts
Bulb Temperature (At hottest point)		240	°C

MAXIMUM CIRCUIT VALUE

Grid-Circuit Resistance▲	0.1	megohm
--------------------------------	-----	--------

Pulse duration must not exceed 15% of a horizontal scanning cycle (10 microseconds).

▲ Larger values of grid-circuit resistance may be used if provisions are made to protect the tube.

Refer to chart at end of section.

For replacement use type 6JH5/6JD5/6HZ5.

6HZ5/6JD5

6HZ6

5HZ6

SHARP-CUTOFF PENTODE

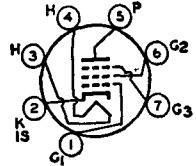

Miniature type used as sound-detector tube in FM and color and black-and-white television receivers. Tube has two independent control grids. **Outlines section, 5C;** requires miniature 7-contact socket. Type 5HZ6 is identical with type 6HZ6 except for heater ratings.

7EN

	5HZ6	6HZ6	
Heater Voltage (ac/dc)	4.75	6.3	volts
Heater Current	0.6	0.45	ampere
Heater Warm-up Time (Average)	11	11	seconds
Heater-Cathode Voltage:			
Peak value	±200 max	±200 max	volts
Average value	100 max	100 max	volts
Direct Interelectrode Capacitances (Approx.):			
Grid No.1 to Plate		0.023	pF
Grid No.1 to Cathode, Heater, Grid No.2, Grid No.3, and Internal Shield		8.2	pF
Grid No.1 to Grid No.3		0.09	pF
Grid No.3 to Plate		1.6	pF
Grid No.3 to Cathode, Heater, Grid No.1, Grid No.2, Plate, and Internal Shield		7.2	pF

Class A₁ Amplifier

CHARACTERISTICS

Plate Supply Voltage	150	volts
Grid-No.3 Supply Voltage	0	volts
Grid-No.2 Supply Voltage	100	volts
Grid-No.1 Supply Voltage	0	volts
Cathode-Bias Resistor	180	ohms
Plate Resistance (Approx.)	0.11	megohm
Transconductance, Grid No.1 to Plate	3400	μmhos
Transconductance, Grid No.3 to Plate	600	μmhos
Plate Current	3.2	mA
Grid-No.2 Current	3.2	mA
Grid-No.3 Supply Voltage (Approx.) for plate current of 20 μA	-7	volts
Grid-No.1 Supply Voltage (Approx.) for plate current of 20 μA	-4.5	volts

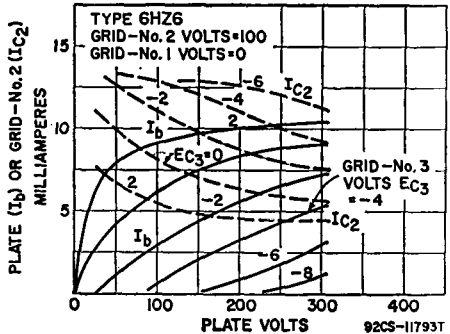
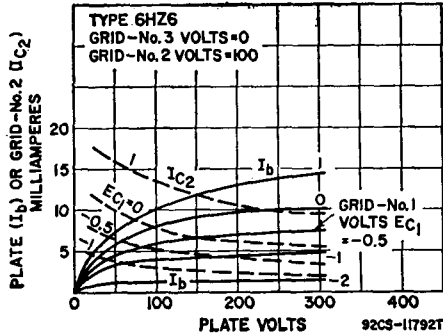

FM Sound Detector

MAXIMUM RATINGS (Design-Maximum Values)

Plate Voltage	300	volts
Grid-No.3 (Control-Grid) Voltage:		
Negative value (dc and peak ac)	100	volts
Positive value (dc and peak ac)	25	volts
Grid-No.2 (Screen-Grid) Supply Voltage	300	volts
Grid-No.2 Voltage	See curve page 300	
Grid-No.1 (Control-Grid) Voltage:		
Negative-bias value	50	volts
Positive-bias value	0	volts
Plate Dissipation	1.7	watts

Grid-No.3 Input	0.1	watt
Grid-No.2 Input:		
For grid-No.2 voltages up to 150 volts	1	watt
For grid-No.2 voltages between 150 and 300 volts	See curve page 300	

MAXIMUM CIRCUIT VALUES

Grid-No.3-Circuit Resistance	0.68	megohm
Grid-No.1-Circuit Resistance:		
For fixed-bias operation	0.22	megohm
For cathode-bias operation	0.47	megohm

Refer to chart at end of section. **6HZ8**

Refer to chart at end of section. **6J4**

Refer to chart at end of section. **6J4WA**

Refer to chart at end of section. **6J5**
6J5GT

Refer to chart at end of section. **6J6**

MEDIUM-MU TWIN TRIODE

6J6A

5J6

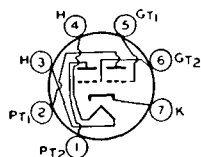

7BF

Miniature type used as combined rf power amplifier and oscillator or as twin af amplifier. With push-pull arrangement of the grids and the plates in parallel, this type can also be used as a mixer at frequencies as high as 600 MHz. Outlines section, 5C; requires miniature 7-contact socket. Type 5J6 is identical with type 6J6A except for heater ratings.

Heater Voltage (ac/dc)	5J6	6J6A	
Heater Current	4.7	6.3	volts
Heater Warm-up Time (Average)	0.6	0.45	ampere
Peak Heater-Cathode Voltage	11	11	seconds
Direct Interelectrode Capacitances	±100 max	±100 max	volts
(Each Unit, Approx.):			
Grid to Plate	Unshielded	Shielded	
Grid to Cathode and Heater	1.6	1.6	pF
Plate to Cathode and Heater (Unit No.1)	2.2	2.6	pF
Plate to Cathode and Heater (Unit No.2)	0.4	1.6	pF
	0.4	1	pF

Class A₁ Amplifier

MAXIMUM RATINGS (Design-Maximum Values)

Plate Voltage	300	volts
Grid Voltage, Positive-bias value	0	volts
Plate Dissipation	1.5	watts

CHARACTERISTICS

Plate Voltage	100	volts
Cathode-Bias Resistor	50†	ohms
Amplification Factor	38	
Plate Resistance (Approx.)	7100	ohms
Transconductance	5300	μmhos
Plate Current	8.5	mA

MAXIMUM CIRCUIT VALUES

Grid-Circuit Resistance:		
For fixed-bias operation	Not	recommended
For cathode-bias operation	0.5	megohm

† Value is for both units operating at the specified conditions.

RF Power Amplifier and Oscillator—Class C Telegraphy

Key-down conditions per tube without modulation

MAXIMUM RATINGS (Design-Center Values, Each Unit)

Plate Voltage	300	volts
Grid Voltage:		
Negative-bias value	40	volts
Positive-bias value	0	volts
Plate Current	15	mA
Grid Current	8	mA
Plate Input	4.5	watts
Plate Dissipation	1.5	watts

TYPICAL PUSH-PULL OPERATION (Both Units)

Plate Voltage	150	volts
Grid Voltage*	-10	volts
Plate Current	30	mA
Grid Current (Approx.)	16	mA
Driving Power (Approx.)	0.35	watt
Power Output (Approx.)	3.5	watts

* Obtained by grid resistor (625 ohms), cathode-bias resistor (220 ohms), or fixed supply.

- 6J6WA** Refer to chart at end of section.
- 6J6WB** Refer to chart at end of section.
- 6J7**
- 6J7G** Refer to chart at end of section.
- 6J7GT**
- 6J8G** Refer to chart at end of section.
- 6J9** Refer to chart at end of section.
- 6J10** Refer to chart at end of section.
For replacement use type 6Z10/6J10.
- 6J11** Refer to chart at end of section.
- 6JA5** Refer to chart at end of section.
- 6JB5** For replacement use type 6JB5/6HE5.

6JB5/6HE5 BEAM POWER TUBE

Duodecar type used as vertical-deflection amplifier in television receivers. Outlines section, 15D; requires duodecar 12-contact socket.

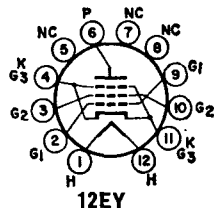

Heater Voltage (ac/dc)	6.3	volts
Heater Current	0.8	ampere
Heater Cathode Voltage:		
Peak value	±200 max	volts
Average value	100 max	volts
Direct Interelectrode Capacitances:		
Grid No.1 to Plate	0.49	pF
Grid No.1 to Cathode, Heater, Grid No.2, and Grid No.3	9.5	pF
Plate to Cathode, Heater, Grid No.2, and Grid No.3	6.5	pF

Class A₁ Amplifier

CHARACTERISTICS			
Plate Voltage	60	250	volts
Grid-No.2 (Screen-Grid) Voltage	250	250	volts
Grid-No.1 (Control-Grid) Voltage	0	-20	volts
Plate Resistance (Approx.)	—	50000	ohms
Transconductance	—	4100	μmhos
Plate Current	180*	43	mA
Grid-No.2 Current	20*	3.5	mA
Grid-No.1 Voltage (Approx.) for plate current of 100 μA	—	-50	volts

* This value can be measured by a method involving a recurrent waveform such that the maximum ratings of the tube will not be exceeded.

Vertical-Deflection Amplifier

For operation in a 525-line, 30-frame system

MAXIMUM RATINGS (Design-Maximum Values)

DC Plate Voltage	350	volts
Peak Positive-Pulse Plate Voltage#	2500	volts
Grid-No.2 Voltage	300	volts
Peak Cathode Current	260	mA
Average Cathode Current	75	mA
Plate Dissipation†	15	watts
Grid-No.2 Input†	2.75	watts
Bulb Temperature (At hottest point)	200	°C

MAXIMUM CIRCUIT VALUES

Grid-No.1-Circuit Resistance:		
For fixed-bias operation	1	megohm
For cathode-bias operation	2.2	megohms

Pulse duration must not exceed 15% of a vertical scanning cycle (2.5 milliseconds).

† A resistor or other means is required to protect the tube in absence of excitation.

Refer to chart at end of section.

6JB6

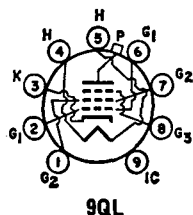

BEAM POWER TUBE

6JB6A

12JB6A, 17JB6A

Novar types used as high-efficiency horizontal-deflection amplifiers in television receivers. Outlines section, 32A; requires novar 9-contact socket. Types 12JB6A and 17JB6A are identical with type 6JB6A except for heater ratings.

	6JB6A	12JB6A	17JB6A	
Heater Voltage (ac/dc)	6.3	12.6	16.8	volts
Heater Current	1.2	0.6	0.45	amperes
Heater Warm-up Time (Average)	—	11	11	seconds
Heater-Cathode Voltage:				
Peak value	±200 max	±200 max	±200 max	volts
Average value	100 max	100 max	100 max	volts
Direct Interelectrode Capacitances (Approx.):				
Grid No.1 to Plate			0.2	pF
Grid No.1 to Cathode, Heater, Grid No.2, and Grid No.3			15	pF
Plate to Cathode, Heater, Grid No.2, and Grid No.3			6	pF

Class A₁ Amplifier

CHARACTERISTICS

	Triode Connection^A	Pentode Connection	
Plate Voltage	150	60 150	volts
Grid No.3 (Suppressor Grid)	—	Connected to cathode at socket	
Grid-No.2 (Screen-Grid) Voltage	—	150 150	volts
Grid-No.1 (Control-Grid) Voltage	-22.5	0 -22.5	volts
Mu-Factor, Grid No.2 to Grid No.1	4.4	—	
Plate Resistance (Approx.)	—	15000	ohms
Transconductance	—	7100	μmhos
Plate Current	—	390 ^a 70	mA
Grid-No.2 Current	—	32 ^a 2.1	mA
Grid-No.1 Voltage for plate current of 1 mA	—	— -42	volts

^A Grid No.2 connected to plate.

* This value can be measured by a method involving a recurrent waveform such that the maximum ratings of the tube will not be exceeded.

Horizontal-Deflection Amplifier

For operation in a 525-line, 30-frame system

MAXIMUM RATINGS (Design-Maximum Values)

DC Plate Supply Voltage	770	volts
Peak Positive-Pulse Plate Voltage#	6500	volts

Peak Negative-Pulse Plate Voltage	1500	volts
DC Grid-No.3 Voltage†	70	volts
DC Grid-No.2 Voltage	220	volts
DC Grid-No.1 Voltage	-55	volts
Peak Negative-Pulse Grid-No.1 Voltage	330	volts
Peak Cathode Current	550	mA
Average Cathode Current	175	mA
Plate Dissipation*	17.5	watts
Grid-No.2 Input	3.5	watts
Bulb Temperature (At hottest point)	240	°C

MAXIMUM CIRCUIT VALUE

Grid-No.1-Circuit Resistance, for grid-resistor-bias operation 1 megohm

Pulse duration must not exceed 15% of a horizontal scanning cycle (10 microseconds).

† For horizontal-deflection service, a positive voltage may be applied to grid No.3 to minimize

"snivets" interference in both vhf and uhf television receivers. A typical value is 30 volts.

* A bias resistor or other means is required to protect the tube in absence of excitation.

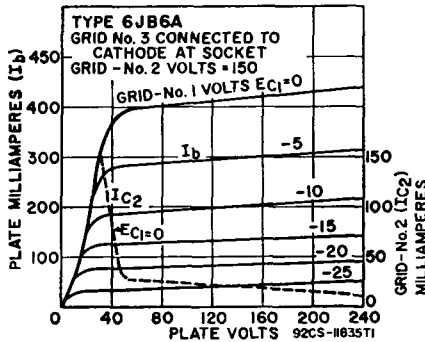

6JC6

Refer to chart at end of section.

6JC6A

SHARP-CUTOFF PENTODE

3JC6A, 4JC6A

Miniature type with frame grid used in if-amplifier stages of color and black-and-white television receivers utilizing intermediate frequencies in the order of 40 MHz. Outlines section, 6B; requires miniature 9-contact socket. Type 4JC6 is identical with type 6JC6 except for heater ratings. Types 3JC6A and 4JC6A are identical with type 6JC6A except for heater ratings.

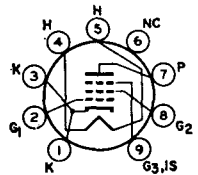

9PM

	3JC6A	4JC6A	6JC6A	
Heater Voltage (ac/dc)	3.5	4.5	6.3	volts
Heater Current	0.6	0.45	0.3	ampere
Heater Warm-up Time (Average)	11	11	—	seconds
Heater-Cathode Voltage:				
Peak value	±200 max	±200 max	±200 max	volts
Average value	100 max	100 max	100 max	volts
Direct Interelectrode Capacitances:				
Grid No.1 to Plate			0.019 max	pF
Grid No.1 to Cathode, Heater, Grid No.2, Grid No.3, and Internal Shield			8.5	pF
Plate to Cathode, Heater, Grid No.2, Grid No.3, and Internal Shield			3	pF

Class A₁ Amplifier

MAXIMUM RATINGS (Design-Maximum Values)

Plate Voltage	330	330	volts
Grid-No.3 (Suppressor-Grid) Voltage, Positive value	0	0	volts
Grid-No.2 (Screen-Grid) Supply Voltage	330	330	volts
Grid-No.2 Voltage		See curve page 300	

Grid-No.1 (Control-Grid) Voltage, Positive-bias value	0	0	volts
Plate Dissipation	2.5	3.1	watts
Grid-No.2 Input:			
For grid-No.2 voltages up to 165 volts	0.6	0.7	watt
For grid-No.2 voltages between 165 and 330 volts			See curve page 300

CHARACTERISTICS

Plate Supply Voltage	125	125	volts
Grid No.3	Connected to cathode at socket		
Grid-No.2 Supply Voltage	125	125	volts
Cathode-Bias Resistor	56	56	ohms
Plate Resistance (Approx.)	0.18	0.18	megohm
Transconductance	15000	16000	μ mhos
Plate Current	13	14	mA
Grid-No.2 Current	3.2	3.4	mA
Grid-No.1 Voltage (Approx.) for plate current of 100 μ A	-3	-3	volts

MAXIMUM CIRCUIT VALUES

Grid-No.1-Circuit Resistance:			
For fixed-bias operation	0.25	0.25	megohm
For cathode-bias operation	1	1	megohm

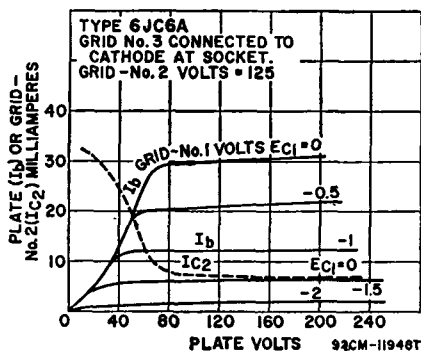

MEDIUM-MU TRIODE—SHARP-CUTOFF PENTODE

6JC8

Miniature type used as combined vhf oscillator and mixer tube in television receivers. Outlines section, 6B; requires miniature 9-contact socket. Heater: volts (ac/dc), 6.3; amperes, 0.45; warm-up time (average), 11 seconds; maximum heater-cathode volts, \pm 200 peak, 100 average.

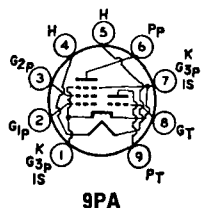

Class A₁ Amplifier

MAXIMUM RATINGS (Design-Maximum Values)	Triode Unit	Pentode Unit	
Plate Voltage	275	275	volts
Grid-No.2 (Screen-Grid) Supply Voltage	—	275	volts
Grid-No.2 Voltage	—	See curve page 300	
Grid-No.1 (Control-Grid) Voltage, Positive-bias value	0	0	volts
Plate Dissipation	1.7	2.3	watts
Grid-No.2 Input:			
For grid-No.2 voltages up to 137.5 volts	—	0.45	watt
For grid-No.2 voltages between 137.5 and 275 volts	—	See curve page 300	

CHARACTERISTICS

Plate Voltage	125	100	125	volts
Grid-No.2 Voltage	—	70	125	volts
Grid-No.1 Voltage	-1	0	-1	volt
Amplification Factor	40	—	—	
Plate Resistance (Approx.)	6000	—	300000	ohms
Transconductance	6500	5700	5500	μ mhos
Plate Current	12	—	9	mA
Grid-No.2 Current	—	—	2.2	mA

Grid-No.1 Voltage (Approx.) for plate current of
20 μ A -7 — 6.5 volts

MAXIMUM CIRCUIT VALUES

Grid-No.1-Circuit Resistance:
For fixed-bias operation — 0.1 megohm
For cathode-bias operation — 0.5 megohm

6JD5

For replacement use type 6JH5/6JD5/6HZ5

6JD6**SHARP-CUTOFF PENTODE**

3JD6, 4JD6

Miniature type with frame grid used as if-amplifier tube in color and black-and-white television receivers utilizing an intermediate frequency in the order of 40 MHz. Outlines section, 6B; requires miniature 9-contact socket. Types 3JD6 and 4JD6 are identical with type 6JD6 except for heater ratings.

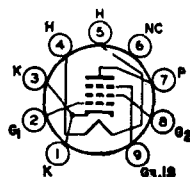
**9PM**

	3JD6	4JD6	6JD6	
Heater Voltage	3.5	4.5	6.3	volts
Heater Current	0.6	0.45	0.3	ampere
Heater Warm-up Time (Average)	11	11	—	seconds
Heater-Cathode Voltage:				
Peak value		± 200 max	± 200 max	volts
Average value		100 max	100 max	volts
Direct Interelectrode Capacitances:				
Grid No.1 to Plate			0.019 max	pF
Grid No.1 to Cathode, Heater, Grid No.2, Grid No.3, and Internal Shield			8.2	pF
Plate to Cathode, Heater, Grid No.2, Grid No.3, and Internal Shield			3	pF

Class A₁ Amplifier**MAXIMUM RATINGS (Design-Maximum Values)**

Plate Voltage	330	volts
Grid-No.3 (Suppressor-Grid) Voltage, Positive value	0	volts
Grid-No.2 (Screen-Grid) Supply Voltage	330	volts
Grid-No.2 Voltage	See curve page 300	
Grid-No.1 (Control-Grid) Voltage, Positive-bias value	0	volts
Plate Dissipation	2.5	watts
Grid-No.2 Input:		
For grid-No.2 voltages up to 165 volts	0.6	watt
For grid-No.2 voltages between 165 and 330 volts	See curve page 300	

**CHARACTERISTICS**

Plate Supply Voltage	125	volts
Grid-No.3 Voltage	0	volts
Grid-No.2 Supply Voltage	125	volts

Grid-No.1 Supply Voltage	0	volts
Cathode-Bias Resistor	56	ohms
Plate Resistance (Approx.)	160000	ohms
Transconductance	14000	μ mhos
Plate Current	15	mA
Grid-No.2 Current	4	mA
Grid-No.1 Voltage (Approx.) for transconductance of 600 μ mhos ..	-4.5	volts

MAXIMUM CIRCUIT VALUES

Grid-No.1-Circuit Resistance:		
For fixed-bias operation	0.25	megohm
For cathode-bias operation	1	megohm

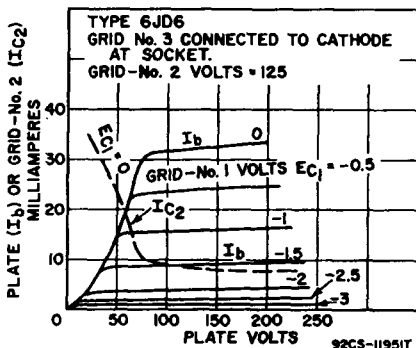
Refer to chart at end of section.
For replacement use type 6MJ6/6LQ6/6JE6C. **6JE6**

Refer to chart at end of section.
For replacement use type 6MJ6/6LQ6/6JE6C. **6JE6A**

For replacement use type 6MJ6/6LQ6/6JE6C. **6JE6C**

Refer to chart at end of section. **6JE8**

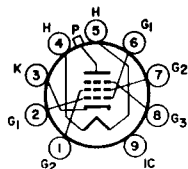

9QL

BEAM POWER TUBE

6JF6

17JF6, 22JF6

Novar type used as horizontal-deflection amplifier in black-and-white television receivers. Outlines section, 18E or 18F; requires novar 9-contact socket. Types 17JF6 and 22JF6 are identical with type 6JF6 except for heater ratings.

	6JF6	17JF6	22JF6	
Heater Voltage (ac/dc)	6.3	16.8	22	volts
Heater Current	1.6	0.6	0.45	amperes
Heater Warm-up Time (Average)	—	11	11	seconds
Heater-Cathode Voltage:				
Peak value	± 200 max	± 200 max	± 200 max	volts
Average value	100 max	100 max	100 max	volts
Direct Interelectrode Capacitances (Approx.):				
Grid No.1 to Plate			1.2	pF
Grid No.1 to Cathode, Heater, Grid No.2, and Grid No.3			22	pF
Plate to Cathode, Heater, Grid No.2, and Grid No.3			9	pF

Class A₁ Amplifier

	Triode ^a		Pentode Connection		
	Connection				
CHARACTERISTICS					
Plate Voltage	125	—	50	130	volts
Peak Positive-Pulse Plate Voltage# ..	—	6500	—	—	volts
Grid No.3 (Suppressor Grid)	Connected to cathode at socket				
Grid-No.2 (Screen-Grid) Voltage	125	125	125	125	volts
Grid-No.1 (Control-Grid) Voltage ..	-20	—	0	-20	volts
Triode Amplification Factor	4.1	—	—	—	
Plate Resistance (Approx.)	—	—	—	12000	ohms
Transconductance	—	—	—	10000	μ mhos
Plate Current	—	—	525†	80	mA
Grid-No.2 Current	—	—	32†	2.5	mA
Grid-No.1 Voltage for plate current of 1 mA	—	-125	—	-40	volts

Horizontal-Deflection Amplifier

For operation in a 525-line, 30-frame system

MAXIMUM RATINGS (Design-Maximum Values)

DC Plate Supply Voltage	770	volts
Peak Positive-Pulse Plate Voltage# ..	6500	volts
Peak Negative-Pulse Plate Voltage	1500	volts
DC Grid-No.3 Voltage ^a	100	volts

DC Grid-No.2 Voltage	220	volts
Peak Negative-Pulse Grid-No.1 Voltage	330	volts
Peak Cathode Current	950	mA
Average Cathode Current	275	mA
Grid-No.2 Input	3.5	watts
Plate Dissipation†	17	watts
Bulb Temperature (At hottest point)	240	°C

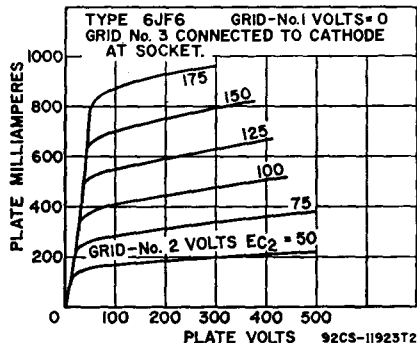
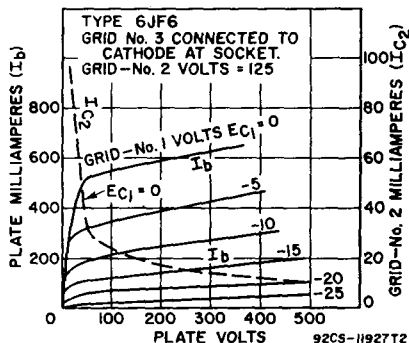

MAXIMUM CIRCUIT VALUES

Grid-No.1-Circuit Resistance:		
For cathode-bias operation	1	megohm
For grid-leak-bias operation	10	megohms
For fixed-bias operation	0.47	megohm

* Grid-No.2 connected to plate at socket.

† This value can be measured by a method involving a recurrent waveform such that the maximum ratings of the tube will not be exceeded.

Pulse duration must not exceed 15% of a horizontal scanning cycle (10 microseconds).

* In this service, a positive value may be applied to grid No.3 to minimize "snivets" interference; a typical value for this voltage is 50 volts.

‡ A bias resistor or other means is required to protect the tube in absence of excitation.

6JG5 SHARP-CUTOFF PENTODE

Miniature type with frame grid used as video output amplifier in color television receivers. **Outlines section, 6E**; requires miniature 9-contact socket. **Heater:** volts, 6.3; amperes, 0.525; maximum heater-cathode volts, ± 200 peak, 100 average.

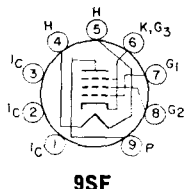

Class A₁ Amplifier

MAXIMUM RATINGS (Design-Maximum Values)

Plate Voltage	330	volts
Grid-No.3 (Suppressor-Grid) Voltage, Positive value	0	volts
Grid-No.2 (Screen-Grid) Supply Voltage	330	volts
Grid-No.2 Voltage	See curve page 300	
Grid-No.1 (Control-Grid) Voltage, Positive value	0	volts
Plate Dissipation	5	watts
Grid-No.2 Input	1.1	watts

CHARACTERISTICS

Plate Voltage	200	60	volts
Grid-No.2 Supply Voltage	150	150	volts
Grid-No.1 Voltage	—	0*	volts
Cathode-Bias Resistor, Bypassed	100	—	ohms
Plate Resistance (Approx.)	60000	—	ohms
Transconductance (Grid No.1 to Plate)	11500	—	μ mhos
Plate Current	25	55	mA
Grid No.2 Current	5.5	18	mA
Grid-No.1 Voltage (Approx.) for plate current of 100 μ A	—10	—	volts

MAXIMUM CIRCUIT VALUES

Grid-No.1-Circuit Resistance:		
For fixed-bias operation	0.25	megohm
For cathode-bias operation	1	megohm

• Applied not exceeding two seconds, to avoid damage to tube.

Refer to chart at end of section.

6JG6

6JG6A

17JG6A, 22JG6A

BEAM POWER TUBE

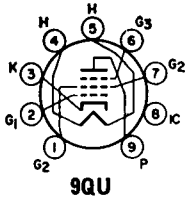

Novar type used as horizontal-deflection amplifier in low-B+, black-and-white television receivers. **Outlines** section, 31D; requires novar 9-contact socket. For curves of average plate characteristics, refer to type 6JF6. Types 17JG6A and 22JG6A are identical with type 6JG6A except for heater ratings.

	6JG6A	17JG6A	22JG6A	
Heater Voltage (ac/dc)	6.3	16.8	22	volts
Heater Current	1.6	0.6	0.45	amperes
Heater Warm-up Time (Average)	—	11	11	seconds
Heater-Cathode Voltage:				
Peak value	±200 max	±200 max	±200 max	volts
Average value	100 max	100 max	100 max	volts
Direct Interelectrode Capacitances:				
Grid No.1 to Plate			0.7	pF
Grid No.1 to Cathode, Heater, Grid No.2, and Grid No. 3			22	pF
Plate to Cathode, Heater, Grid No.2, and Grid No.3			9	pF

Class A₁ Amplifier

CHARACTERISTICS

	Triode= Connection	Pentode Connection	
Plate Voltage	125	50 130	volts
Grid-No.3 (Suppressor Grid)	—	Connected to cathode at socket	
Grid-No.2 (Screen-Grid) Voltage	—	125 125	volts
Grid-No.1 (Control-Grid) Voltage	-20	0 -20	volts
Amplification Factor	4.1	—	
Plate Resistance (Approx.)	—	12000	ohms
Transconductance	—	10000	μmhos
Plate Current	—	525* 80	mA
Grid-No.2 Current	—	32* 2.5	mA
Grid-No.1 Voltage (Approx.), for plate current of 1 mA	—	— -40	volts

* With grid No.2 connected to plate at socket.

• This value can be measured by a method involving a recurrent waveform such that the maximum ratings of the tube will not be exceeded.

Horizontal-Deflection Amplifier

For operation in a 525-line, 30-frame system

MAXIMUM RATINGS (Design-Maximum Values)

DC Plate Supply Voltage	770	volts
Peak Positive-Pulse Plate Voltage#	6500	volts
Peak Negative-Pulse Plate Voltage	1500	volts
DC Grid-No.3 Voltage*	75	volts
DC Grid-No.2 Voltage	220	volts
DC Grid-No.1 Voltage, Negative-bias value	-55	volts
Peak Negative-Pulse Grid-No.1 Voltage	330	volts
Peak Cathode Current	950	mA
Average Cathode Current	275	mA
Plate Dissipation†	17	watts
Grid-No.2 Input	3.5	watts
Bulb Temperature (At hottest point)	240	°C

MAXIMUM CIRCUIT VALUE

Grid-No.1-Circuit Resistance, for grid-No.1-resistor-bias operation	2.2	megohms
---------------------------------------------------------------------	-----	---------

Pulse duration must not exceed 15% of a horizontal scanning cycle (10 microseconds).
* In a horizontal-deflection-amplifier service, a positive voltage (typical value, 30 volts) may be applied to grid No.3 to reduce "snivets" interference, which may occur in both vhf and uhf television receivers.

† A bias resistor or other means is required to protect the tube in absence of excitation.

6JH5

6JH5/6HZ5/6JD5

BEAM TRIODE

Duodecar type used as a pulse-type regulator in the high-voltage power supply of color television receivers. Outlines section, 15F; requires duodecar 12-contact socket. Heater: volts (ac/dc), 6.3; amperes, 2.4.

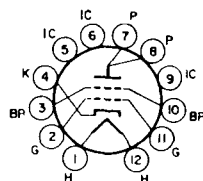
**12JE****Class A₁ Amplifier****CHARACTERISTICS**

Pulse Plate Voltage*	3500	volts
Grid No.2 (Beam Plate)	Connected to cathode at	socket
Grid-Voltage, Negative-bias value	4.4	volts
Peak Plate Current	300	mA
Amplification Factor	300	
Transconductance	65000	μmhos
Plate Resistance (Approx.)	4600	ohms
Grid Voltage (Approx.) for plate current of 1 mA	-16	volts

* Duty cycle of the pulse must be less than 2.5%.

High-Voltage Regulator Service

For operation in a 525-line, 30-frame system

MAXIMUM RATINGS (Design-Maximum Values)

Peak Plate Voltage#	5500	volts
Plate Dissipation	35	watts
Peak Plate Current	325	mA
Heater-Cathode Voltage:		
Peak value	+200 — 450	volts
Average value	100	volts
Bulb Temperature (At hottest point)	240	°C

MAXIMUM CIRCUIT VALUE

Grid-Circuit Resistance [▲]	0.1	megohm
--------------------------------------	-----	--------

Pulse duration must not exceed 15% of a horizontal scanning cycle (10 microseconds).

▲ Larger values of grid-circuit resistance may be used if provisions are made to protect the tube.

6JH6

4JH6

**SEMIREMOTE-CUTOFF
PENTODE**

Miniature type used in the gain-controlled picture if-amplifier stages of color and black-and-white television receivers. Outlines section, 5C; requires miniature 7-contact socket. For curves of average plate characteristics, refer to type 6BZ6. Type 4JH6 is identical with type 6JH6 except for heater ratings.

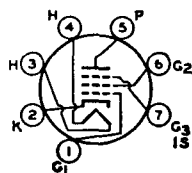
**7CM**

Heater Arrangement	4JH6 Series	6JH6 Parallel	
Heater Voltage (ac/dc)	4.2	6.3	volts
Heater Current	0.45	0.3	ampere
Heater Warm-up Time	11	—	seconds
Heater-Cathode Voltage:			
Peak value	±200 max	±200 max	volts
Average value	100 max	100 max	volts
Direct Interelectrode Capacitances:	Unshielded	Shielded*	
Grid No.1 to Plate	0.025 max	0.015 max	pF
Grid No.1 to Cathode, Heater, Grid No.2, Grid No.3, and Internal Shield	7	7	pF
Plate to Cathode, Heater, Grid No.2, Grid No.3, and Internal Shield	2	3	pF

* With external shield connected to cathode.

Class A₁ Amplifier

MAXIMUM RATINGS (Design-Maximum Values)

Plate Voltage	300	volts
Grid-No.3 (Suppressor-Grid) Voltage, Positive value	0	volts
Grid-No.2 (Screen-Grid) Supply Voltage	300	volts
Grid-No.2 Voltage	See curve page 300	
Grid-No.1 (Control-Grid) Voltage, Positive-bias value	0	volts
Grid-No.2 Input:		
For grid-No.2 voltages up to 150 volts	0.55	watt
For grid-No.2 voltages between 150 and 300 volts	See curve page 300	

CHARACTERISTICS

Plate Supply Voltage	125	volts
Grid-No.3	Connected to cathode at socket	
Grid-No.2 Supply Voltage	125	volts
Cathode-Bias Resistor	56	ohms
Plate Resistance (Approx.)	0.26	megohm
Transconductance	8000	μ mhos
Transconductance Range for grid-No.1 voltage of -4.5 volts and cathode-bias resistor of 56 ohms	400-900	μ mhos
Plate Current	14	mA
Grid-No.2 Current	3.6	mA
Grid-No.1 Voltage (Approx.) for transconductance of 50 μ mhos	-19	volts

MAXIMUM CIRCUIT VALUES

Grid-No.1-Circuit Resistance:		
For fixed-bias operation	0.25	megohm
For cathode-bias operation	1	megohm

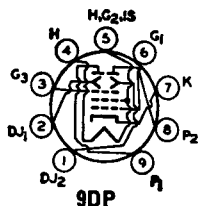

BEAM-DEFLECTION TUBE

6JH8

Miniature type used in color-demodulator and burst-gate circuits in color television receivers. This type has two plates and two deflecting electrodes; the control grid varies beam deflection. **Outlines section, 6E;** requires miniature 9-contact socket. Pin 5 should be connected to cathode at socket. The 6JH8 should be

so located in the equipment that it is not subjected to stray magnetic fields.

Heater Voltage (ac/dc)	6.3	volts
Heater Current	0.3	amperes
Direct Interelectrode Capacitances:		
Grid No.1 to All Other Electrodes, Except Both Plates	7.5	pF
Grid No.1 to Deflecting Electrode No.1	0.04 max	pF
Grid No.1 to Deflecting Electrode No.2	0.07 max	pF
Plate No.1 to All Other Electrodes	5	pF
Plate No.2 to All Other Electrodes	5	pF
Plate No.1 to Plate No.2	0.4	pF
Deflecting Electrode No.1 to All Other Electrodes	4.8	pF
Deflecting Electrode No.2 to All Other Electrodes	4.8	pF
Deflecting Electrode No. 1 to Deflecting Electrode No.2	0.38	pF

Color TV Demodulator

MAXIMUM RATINGS (Design-Maximum Values)

Plate Voltage (Each Plate)	330	volts
Peak Deflecting-Electrode Voltage (Each Electrode):		
Negative value	165	volts
Positive value	165	volts
Grid-No.3 (Accelerating-Grid) Voltage	330	volts
Grid-No.1 (Control-Grid) Voltage, Positive-bias value	0	volts
Cathode Current	33	mA
Plate Dissipation (Each Plate)	3	watts
Grid-No.3 Input	1	watt

MAXIMUM CIRCUIT VALUES

Grid-No.1 Circuit Resistance:		
For fixed-bias operation	0.1	megohm
For cathode-bias operation	0.25	megohm

Class A₁ Amplifier

With both plates connected together and with both deflecting electrodes connected to cathode at socket

CHARACTERISTICS

Plate-No.1 Supply Voltage	250	volts
Plate-No.2 Supply Voltage	250	volts
Grid-No.3 Voltage	250	volts
Cathode-Bias Resistor	220	ohms
Transconductance	4400	μmhos
Total Plate Current	14	mA
Grid-No.3 Current	1.5	mA
Grid-No.1 Voltage (Approx.) for total plate current of 10 μA ...	-13	volts

6JK6 Refer to chart at end of section.

6JK8 Refer to chart at end of section.

6JM6 Refer to chart at end of section.

6JM6A

17JM6A

BEAM POWER TUBE

Duodecar types used as horizontal-amplifier tubes in color and black-and-white television receivers. Outlines section, 39A; requires duodecar 12-contact socket. Type 17JM6A is identical with type 6JM6A except for heater ratings.

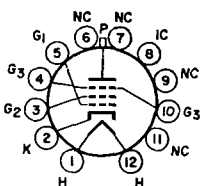

12FJ

	6JM6A	17JM6A	
Heater Voltage (ac/dc)	6.3	16.8	volts
Heater Current	1.2	0.45	amperes
Heater Warm-up Time (Average)	—	11	seconds
Heater-Cathode Voltage:			
Peak value	±200 max	±200 max	volts
Average value	100 max	100 max	volts
Direct Interelectrode Capacitances:			
Grid No.1 to Plate		0.6	pF
Grid No.1 to Cathode, Heater, Grid No.2, and Grid No.3		16	pF
Plate to Cathode, Heater, Grid No. 2, and Grid No. 3		7	pF

Class A₁ Amplifier

CHARACTERISTICS

	Pentode Connection		Triode** Connection		
Plate Voltage	5000	55	250	150	volts
Grid-No.3 (Suppressor-Grid)	Connected to cathode at socket				
Grid-No.2 (Screen-Grid) Voltage	150	150	150	150	volts
Grid-No.1 (Control-Grid) Voltage	—	0	-22.5	-22.5	volts
Plate Resistance (Approx.)	—	—	15000	—	ohms
Transconductance	—	—	7300	—	μmhos
Plate Current	—	345*	65	—	mA
Grid-No.2 Current	—	30*	1.8	—	mA
Grid-No.1 Voltage (Approx.) for plate current of 1 μA	-100	—	-42	—	volts
Amplification Factor	—	—	—	4.4	

MAXIMUM CIRCUIT VALUE

Grid-No.1-Circuit Resistance	1	megohm
------------------------------------	---	--------

* This value can be measured by a method utilizing a recurrent waveform such that the maximum ratings of the tube will not be exceeded.

** Grid No.2 tied to plate.

Horizontal-Deflection Amplifier

For operation in a 525-line, 30-frame system

MAXIMUM RATINGS (Design-Maximum Values)

DC Plate Supply Voltage	770	volts
Peak Positive-Pulse Plate Voltage#	6500	volts
Peak Negative-Pulse Plate Voltage	1500	volts
DC Grid-No.3 Voltage	70	volts

DC Grid-No.2 Voltage	220	volts
DC Grid-No.1 Voltage, Negative-bias value	55	volts
Peak Negative-Pulse Grid-No.1 Voltage	330	volts
Average Cathode Current	175	mA
Peak Cathode Current	550	mA
Plate Dissipation#	17.5	watts
Grid-No.2 Input	3.5	watts
Bulb Temperature (At hottest point)	220	°C

Pulse duration must not exceed 15% of a horizontal scanning cycle (10 microseconds).
 ## A bias resistor or other means is required to protect the tube in absence of excitation.

6JN6

12JN6, 17JN6

BEAM POWER TUBE

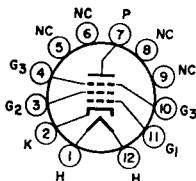

12FK

Duodecar type used as horizontal-amplifier tube in color and black-and-white television receivers. Outlines section, 15A; requires duodecar 12-contact socket. This type is electrically identical with type 6JM6 except that it has a slightly lower grid-No.1-to-plate capacitance. Types 12JN6 and 17JN6 are identical with type 6JN6 except for heater ratings.

Heater Voltage (ac/dc)	6JN6	12JN6	17JN6	
Heater Current	6.3	12.6	16.8	volts
Heater Warm-up Time (Average)	1.2	0.6	0.45	amperes
Direct Interelectrode Capacitances:		11	11	seconds
Grid No.1 to Plate			0.34	pF
Grid No.1 to Cathode, Heater, Grid No.2, and Grid No.3			16	pF
Plate to Cathode, Heater, Grid No.2, and Grid No.3			7	pF

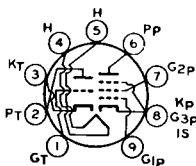

9FA

MEDIUM-MU TRIODE— SHARP-CUTOFF PENTODE

6JN8

19JN8/19CL8A

Miniature type used as FM converter and rf amplifier in radio receivers. Outlines section, 6B; requires miniature 9-contact socket. Type 19JN8/19CL8A is identical with type 6JN8 except for heater ratings.

Heater Voltage (ac/dc)	6JN8	19JN8/ 19CL8A	
Heater Current	6.3	18.9	volts
Heater Warm-up Time (Average)	0.45	0.15	ampere
Heater-Cathode Voltage:	11	—	seconds
Peak value	±200 max	±200 max	volts
Average value	100 max	100 max	volts
Direct Interelectrode Capacitances:*			
Pentode Unit:			
Grid No.1 to Plate		0.01	pF
Grid No.1 to Cathode, Heater, Grid No.2, Grid No.3, and Internal Shield		5.5	pF
Plate to Cathode, Heater, Grid No.2, Grid No.3, and Internal Shield		3.4	pF
Triode Unit:			
Grid to Plate		1.7	pF
Grid to Cathode, Heater, Pentode Cathode, Grid No.3, and Internal Shield		3.2	pF
Plate to Cathode, Heater, Pentode Cathode, Grid No.3, and Internal Shield		2.2	pF

* With external shield connected to cathode of unit under test.

Class A₁ Amplifier

MAXIMUM RATINGS (Design-Maximum Values)

Plate Voltage	300	300	volts
Grid-No.2 (Screen-Grid) Supply Voltage	—	300	volts
Grid-No.2 Voltage	—	See curve page 300	

Grid-No.1 (Control-Grid) Voltage, Positive-bias value	0	0	volts
Plate Dissipation	2.5	2.5	watts
Grid-No.2 Input:			
For grid-No.2 voltages up to 150 volts	—	0.55	watt
For grid-No.2 voltages between 150 and 300 volts	—	See curve	page 300

CHARACTERISTICS

Plate Voltage	125	125	volts
Grid-No.2 Voltage	—	125	volts
Grid-No.1 Voltage	—1	—1	volt
Amplification Factor	46	—	
Plate Resistance (Approx.)	5400	200000	ohms
Transconductance	8500	7500	μ mhos
Plate Current	13.5	12	mA
Grid-No.2 Current	—	4	mA
Grid-No.1 Voltage (Approx.) for plate current of 10 μ A	—8	—8	volts

MAXIMUM CIRCUIT VALUES

Grid-No.1-Circuit Resistance:			
For fixed-bias operation	2.2	2.2	megohms
For cathode-bias operation	2.2	2.2	megohms

6JQ6

12JQ6, 17JQ6,

**BEAM POWER TUBE
with integral diode**

Miniature type featuring integral diode, internally connected to grid No.3, used in feedback-stabilized vertical-deflection-amplifier applications in color and black-and-white television receivers. Outlines section, 6G; requires miniature 9-contact socket. Types 12JQ6 and 17JQ6 are identical with type 6JQ6 except for heater ratings.

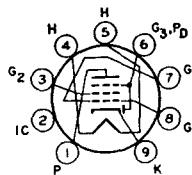
**9RA**

	6JQ6	12JQ6	17JQ6	
Heater Voltage (ac/dc)	6.3	12.6	17	volts
Heater Current	1.2	0.6	0.45	amperes
Heater Warm-up Time (Average)	—	11	11	seconds
Heater-Cathode Voltage:				
Peak value	± 200 max	± 200 max	± 200 max	volts
Average value	100 max	100 max	100 max	volts
Direct Interelectrode Capacitances:				
Grid No.1 to Plate			0.32	pF
Grid No.1 to Cathode, Heater, Grid No.2, Grid No.3, and Diode Plate			13	pF
Plate to Cathode, Heater, Grid No.2, Grid No.3, and Diode Plate			6	pF

Class A₁ Amplifier**CHARACTERISTICS**

Plate Voltage	40	140	volts
Grid-No.3 (Suppressor-Grid) Voltage	0	0	volts
Grid-No.2 (Screen-Grid) Voltage	120	140	volts
Grid-No.1 (Control-Grid) Voltage	0	—18	volts
Triode Amplification Factor*	—	6.5	
Plate Resistance (Approx.)	—	10500	ohms
Transconductance	—	4200	μ mhos
Plate Current	150#	35	mA
Grid-No.2 Current	20#	2.5	mA
Grid-No.1 Voltage for plate current of 1 mA	—	—37	volts
Instantaneous Diode-Plate-to-Cathode Voltage Drop for Instantaneous Diode-Plate Current of 2 mA	—	5	volts

Vertical-Deflection Amplifier

For operation in a 525-line, 30-frame system

MAXIMUM RATINGS (Design-Maximum Values)

DC Plate Voltage	425	volts
Peak Positive-Pulse Plate Voltage (Absolute-Maximum Value)*	2000	volts
DC Grid-No.3 and Diode-Plate Voltage	+10 —150	volts

DC Grid-No.2 Voltage	330	volts
Peak Negative-Pulse Grid-No.1 Voltage	150	volts
Average Cathode Current	70	mA
Peak Cathode Current	250	mA
Average Diode-Plate (and Grid-No.3) Current	1	mA
Plate Dissipation	10	watts
Grid-No.2 Input	2	watts
Bulb Temperature (At hottest point)	240	°C

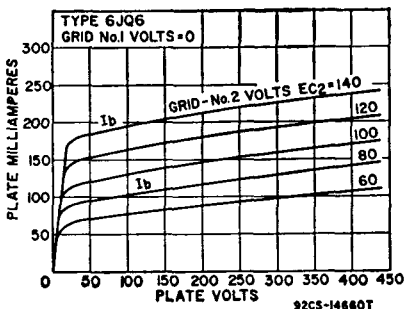
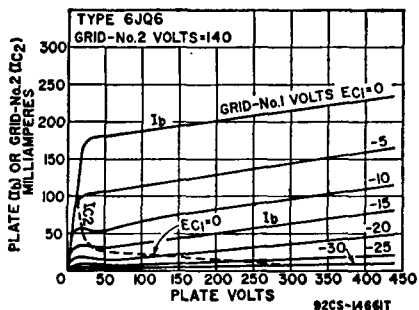

MAXIMUM CIRCUIT VALUES

Grid-No.1—Circuit Resistance:		
For grid-No.1-resistor-bias operation	2.2	megohms
For cathode-bias operation	2.2	megohms

* Grid No.3 and diode plate connected to cathode, and grid-No.2 connected to plate at socket.

This value can be measured by a method involving a recurrent waveform such that the maximum ratings of the tube will not be exceeded.

* Pulse duration must not exceed 15% of a vertical scanning cycle (2.5 milliseconds).

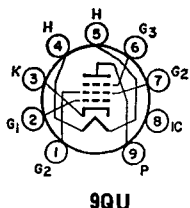

9QU

BEAM POWER TUBE

6JR6

17JR6, 22JR6, 33JR6

Novar type used for horizontal-deflection amplifier service in low B+, black-and-white television receivers. Outlines section, 31D; requires novar 9-contact socket. Types 17JR6, 22JR6 and 33JR6 are identical with type 6JR6 except for heater ratings.

	6JR6	17JR6	22JR6	33JR6	
Heater Voltage (ac/dc)	6.3	16.8	22	33	volts
Heater Current	1.6	0.6	0.45	0.3	amperes
Heater Warm-up Time (Average)	—	11	11	11	seconds
Heater-Cathode Voltage:					
Peak value	±200 max	±200 max	±200 max	±200 max	volts
Average value	100 max	100 max	100 max	100 max	volts
Direct Interelectrode Capacitances (Approx.):					
Grid No.1 to Plate				0.7	pF
Grid No.1 to Cathode, Heater, Grid No.2, and Grid No.3				22	pF
Plate to Cathode, Heater, Grid No.2, and Grid No.3				9	pF

Class A₁ Amplifier

CHARACTERISTICS	Triode* Connection		Pentode Connection		
	Plate Voltage	125	—	50	
Peak Positive-Pulse Plate Voltage#	—	—	5500	—	volts
Grid No.3 (Suppressor Grid)			Connected to cathode at socket		
Grid-No.2 (Screen-Grid) Voltage	125	125	125	125	volts
Grid-No.1 (Control-Grid) Voltage	—20	—	0	—20	volts
Plate Resistance (Approx.):	—	—	—	18000	ohms
Transconductance	—	—	—	7000	μmhos

Plate Current	—	—	470 \ddagger	45	mA
Grid-No.2 Current	—	—	32 \ddagger	1.5	mA
Grid-No.1 Voltage for plate current of 1 mA	—	-75	—	-32	volts
Amplification Factor	4.7	—	—	—	

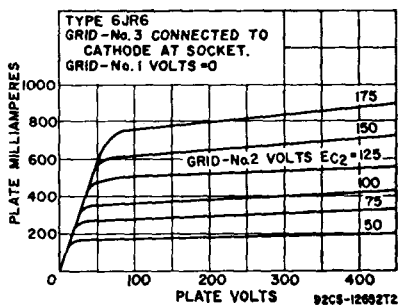
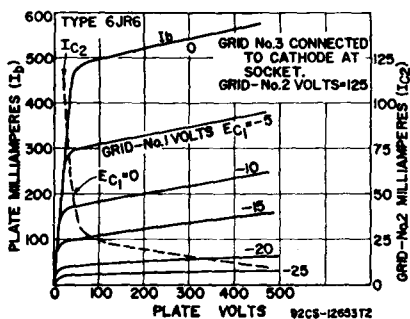

Horizontal-Deflection Amplifier

For operation in a 525-line, 30-frame system

MAXIMUM RATINGS (Design-Maximum Ratings)

Plate Supply Voltage	770	volts
Peak Positive-Pulse Plate Voltage#	6500	volts
Peak Negative-Pulse Plate Voltage	1500	volts
Grid-No.3 Voltage*	75	volts
Grid-No.2 Voltage	220	volts
Grid-No.1 Voltage, Negative-bias value	55	volts
Peak Negative-Pulse Grid-No.1 Voltage	330	volts
Peak Cathode Current	950	mA
Average Cathode Current	275	mA
Grid-No.2 Input	3.5	watts
Plate Dissipation*	17	watts
Bulb Temperature (At hottest point)	240	°C

MAXIMUM CIRCUIT VALUES

Grid-No.1-Circuit Resistance:		
Cathode bias (with min. Rk = 100 Ω)	1	megohm
Grid-leak bias (with signal peak clamped to zero bias)	10	megohms
Fixed bias (where positive grid current is not drawn)	0.47	megohm

* Grid No. 2 connected to plate at socket.

Pulse duration must not exceed 15% of one horizontal scanning cycle (10 microseconds).

‡ This value can be measured by a method involving a recurrent waveform such that the maximum ratings of the tube will not be exceeded.

* In this service, a positive value may be applied to grid No.3 to minimize "snivets" interference; a typical value for this voltage is 30 volts.

* A bias resistor or other means is required to protect the tube in absence of excitation.

6JS6
6JS6A

Refer to chart at end of section.

6JS6C

BEAM POWER TUBE

2JS6A, 3JS6C

Duodecar types used as horizontal-deflection amplifiers in color and black-and-white television receivers. Outlines section, 16B; requires duodecar 12-contact socket. Types 2JS6A and 3JS6A are identical with type 6JS6C except for heater ratings.

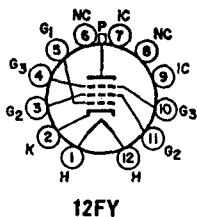

	6JS6C	2JS6A	3JS6A	
Heater Voltage (ac/dc)	6.3	23.6	31.5	volts
Heater Current	2.25	0.6	0.45	amperes
Heater Warm-up Time (Average)	—	11	11	seconds

Heater-Cathode Voltage:

Peak value	±200 max	±200 max	±200 max	volts
Average value	100 max	100 max	100 max	volts

Direct Interelectrode Capacitances:

Grid No.1 to Plate	0.7	pF
Grid No.1 to Cathode, Heater, Grid No.2, and Grid No.3	24	pF
Plate to Cathode, Heater, Grid No.2, and Grid No.3	10	pF

Class A₁ Amplifier

CHARACTERISTICS	Triode†† Connection	5000	Pentode Connection	
Plate Voltage	125	5000	60 175	volts
Grid No.3 (Suppressor Grid)	---	---	Connected to cathode at socket	
Grid-No.2 (Screen-Grid) Voltage	125	125	125 125	volts
Grid-No.1 (Control-Grid) Voltage	-25	---	0 -25	volts
Plate Resistance (Approx.)	---	---	---	ohms
Transconductance	---	---	11500	μmhos
Plate Current	---	---	600‡	mA
Grid-No.2 Current	---	---	32‡	mA
Grid-No.1 Voltage (Approx.) for plate current of 1 mA	---	-125	---	volts
Triode Amplification Factor	3	---	---	

‡ This value can be measured by a method involving a recurrent waveform such that the maximum ratings of the tube will not be exceeded.

†† Grid No.2 connected to plate.

Horizontal-Deflection Amplifier

For operation in a 525-line, 30-frame system

MAXIMUM RATINGS (Design-Maximum Values)

DC Plate Supply Voltage	990	volts
Peak Positive-Pulse Plate Voltage#	7500	volts
Peak Negative-Pulse Plate Voltage	1200	volts
DC Grid-No.3 Voltage	75	volts
DC Grid-No.2 Voltage	220	volts
Peak Negative-Pulse Grid-No.1 Voltage	330	volts
Average Cathode Current	350	mA
Peak Cathode Current	1200	mA
Plate Dissipation**	30	watts
Grid-No.2 Input	5.5	watts
Bulb Temperature (At hottest point)	225	°C

MAXIMUM CIRCUIT VALUE

Grid-No.1-Circuit Resistance		
For grid bias feedback HV regulation	0.47	megohm
For dc or pulse shunt HV regulation	10	megohms

Pulse duration must not exceed 15% of one horizontal scanning cycle (10 microseconds).

** A bias resistor or other means is required to protect the tube in absence of excitation

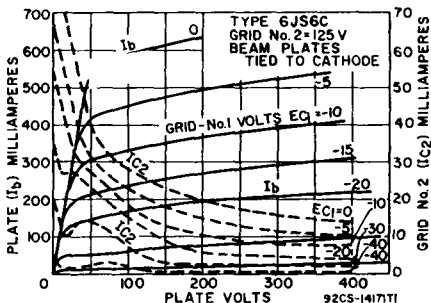

Refer to chart at end of section.

6JT6A

12JT6A, 17JT6A

BEAM POWER TUBE

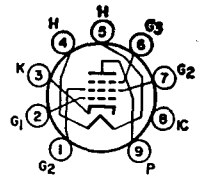

9QU

Novar types used as horizontal-deflection amplifiers in high-efficiency deflection circuits of black-and-white television receivers employing wide-angle or high-voltage picture tubes. Outlines section, 31A; requires novar 9-contact socket. Types 12JT6A and 17JT6A are identical with type 6JT6A except for heater ratings.

	6JT6A	12JT6A	17JT6A	
Heater Voltage (ac/dc)	6.3	12.6	16.8	volts
Heater Current	1.2	0.6	0.45	amperes
Heater Warm-up Time (Average)	—	11	11	seconds
Heater-Cathode Voltage:				
Peak value	±200 max	±200 max	±200 max	volts
Average value	100 max	100 max	100 max	volts
Direct Interelectrode Capacitances:				
Grid No.1 to Plate	—	—	0.26	pF
Grid No.1 to Cathode, Heater, Grid No.2, and Grid No.3	—	—	15	pF
Plate to Cathode, Heater, Grid No.2, and Grid No.3	—	—	6.5	pF

Class A₁ Amplifier

CHARACTERISTICS

	Pentode Connection		Triode* Connection	
Plate Voltage	60	250	150	volts
Grid-No.3 (Suppressor Grid)	Connected to cathode at socket			
Grid-No.2 (Screen-Grid) Voltage	150	150	150	volts
Grid-No.1 (Control-Grid) Voltage	0	-22.5	-22.5	volts
Triode Amplification Factor	—	—	4.4	
Plate Resistance (Approx.)	—	15000	—	ohms
Transconductance	—	7100	—	μmhos
Plate Current	390*	70	—	mA
Grid-No.2 Current	32*	2.1	—	mA
Grid-No.1 Voltage (Approx.) for plate current of 1 mA	—	-42	—	volts

* Grid No.2 connected to plate.

* This value can be measured by a method involving a recurrent waveform such that the maximum ratings of the tube will not be exceeded.

Horizontal-Deflection Amplifier

For operation in a 525-line, 30-frame system

MAXIMUM RATINGS (Design-Maximum Values)

DC Plate Supply Voltage	770	volts
Peak Positive-Pulse Plate Voltage#	6500	volts
Peak Negative-Pulse Plate Voltage	1500	volts
DC Grid-No.3 Voltage ^Δ	70	volts
DC Grid-No.2 Voltage	220	volts
DC Grid-No.1 Voltage, Negative-bias value	55	volts
Peak Negative-Pulse Grid-No.1 Voltage	330	volts

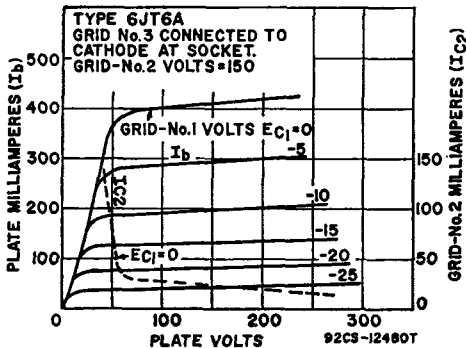

Peak Cathode Current	550	mA
Average Cathode Current	175	mA
Plate Dissipation†	17.5	watts
Grid-No.2 Input	3.5	watts
Bulb Temperature (At hottest point)	240	°C

MAXIMUM CIRCUIT VALUE

Grid-No.1-Circuit Resistance, for grid-resistor-bias operation 1 megohm

Pulse duration must not exceed 15% of a horizontal scanning cycle (10 microseconds).

† A positive voltage may be applied to grid No.3 to reduce interference from "snivets" which may occur in television receivers. A typical value for this voltage is 30 volts.

‡ A bias resistor or other means is required to protect the tube in absence of excitation.

**HIGH-MU TRIODE—
SHARP-CUTOFF PENTODE**

6JT8

10JT8

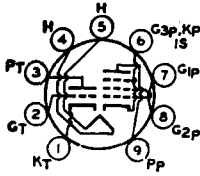

9DX

Neonovial type with frame-grid pentode unit used in color and black-and-white television receivers. The triode unit is used as a voltage-amplifier or sync-separator tube, and the pentode unit is used as a video-amplified tube. Outlines section, 10A, except base is small-button miniature 9-pin; requires miniature 9-contact socket. Type 10JT8 is identical with type 6JT8 except for heater ratings.

	6JT8	10JT8	
Heater Voltage (ac/dc)	6.3	10.2	volts
Heater Current	0.725	0.45	ampere
Heater Warm-up Time (Average)	—	11	seconds
Heater-Cathode Voltage:			
Peak value	±200 max	±200 max	volts
Average value	100 max	100 max	volts

Class A₁ Amplifier

MAXIMUM RATINGS (Design-Maximum Values)

Plate Voltage	330
Grid-No.2 (Screen-Grid) Supply Voltage	—
Grid-No.2 Voltage	—
Grid-No.1 (Control-Grid) Voltage, Positive-bias value	0
Plate Dissipation	1
Grid-No.2 Input:	
For grid-No.2 voltages up to 165 volts	—
For grid-No.2 voltages between 165 and 330 volts	—

Triode Unit	Pentode Unit	
330	330	volts
—	330	volts
—	See curve page 300	
0	0	volts
1	4	watts
—	1.1	watts
—	See curve page 300	

CHARACTERISTICS

Plate Supply Voltage	250	50	200	volts
Grid-No.2 Supply Voltage	—	100	100	volts
Grid-No.1 Voltage	-2	0	—	volts
Cathode-Bias Resistor	—	—	82	ohms
Amplification Factor	100	—	—	
Plate Resistance (Approx.)	37000	—	50000	ohms
Transconductance	2700	—	20000	μmhos
Plate Current	1.5	55*	17	mA
Grid-No.2 Current	—	18*	3.5	mA
Grid-No.1 Voltage (Approx.) for plate current of 100 μA	—	—	-5	volts
Grid-No.1 Voltage (Approx.) for plate current of 20 μA	-5.3	—	—	volts

MAXIMUM CIRCUIT VALUES

Grid-No.1-Circuit Resistance:			
For fixed-bias operation	0.5	0.25	megohm
For cathode-bias operation	1	1	megohm

* This value can be measured by a method involving a recurrent waveform such that the maximum ratings of the tube will not be exceeded.

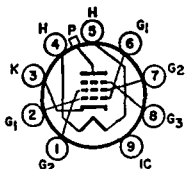

9QL

BEAM POWER TUBE

6JU6

22JU6

Novar type used as horizontal-deflection amplifier in color television receivers. Outlines section, 18E or 18F; requires novar 9-contact socket. Type 22JU6 is identical with type 6JU6 except for heater ratings.

	6JU6	22JU6	
Heater Voltage (ac/dc)	6.3	20	volts
Heater Current	1.6	0.45	amperes
Heater Warm-up Time	—	11	seconds
Heater-Cathode Voltage:			
Peak value	±200 max	±200 max	volts
Average value	100 max	100 max	volts
Direct Interelectrode Capacitances:			
Grid No.1 to Plate		1.2	pF
Grid No.1 to Cathode, Heater, Grid No.2, and Grid No.3		22	pF
Plate to Cathode, Heater, Grid No.2, and Grid No.3		9	pF

Class A₁ Amplifier

CHARACTERISTICS	Triode† Connection		Pentode Connection		
Plate Voltage	125	—	50	130	volts
Peak Positive-Pulse Plate Voltage#	—	6500	—	—	volts
Grid No.3 (Suppressor Grid)			Connected to cathode at socket		
Grid-No.2 (Screen-Grid) Voltage	125	125	125	125	volts
Grid-No.1 (Control-Grid) Voltage	-20	—	0	-20	volts
Amplification Factor	4.7	—	—	—	
Plate Resistance (Approx.)	—	—	—	18000	ohms
Transconductance	—	—	—	7000	μmhos
Plate Current	—	—	470††	45	mA
Grid-No.2 Current	—	—	32††	1.5	mA
Grid-No.1 Voltage for plate current of 1 mA	—	-75	—	-32	volts

Horizontal-Deflection Amplifier

For operation in a 525-line, 30-frame system

MAXIMUM RATINGS (Design-Maximum Values)		
DC Plate Supply Voltage	770	volts
Peak Positive-Pulse Plate Voltage#	6500	volts
Peak Negative-Pulse Plate Voltage	1500	volts
DC Grid-No.3 Voltage*	75	volts
DC Grid-No.2 Voltage	220	volts
DC Grid-No.1 Voltage, Negative-bias value	55	volts
Peak Negative Pulse Grid-No.1 Voltage	330	volts
Peak Cathode Current	950	mA
Average Cathode Current	275	mA
Grid-No.2 Input	3.5	watts
Plate Dissipation**	17	watts
Bulb Temperature (At hottest point)	240	°C

MAXIMUM CIRCUIT VALUES		
Grid-No.1-Circuit Resistance:		
For grid-resistor-bias operation	0.47	megohm
For plate-pulsed operation	10	megohms

Pulse duration must not exceed 15% of one horizontal scanning cycle (10 microseconds).

† Grid No.2 connected to plate.

†† This value can be measured by a method involving a recurrent waveform such that the maximum ratings of the tube will not be exceeded.

* In this service, a positive value may be applied to grid No.3 to minimize "snivets" interference; a typical value for this voltage is 30 volts.

** A bias resistor or other means is required to protect the tube in absence of excitation.

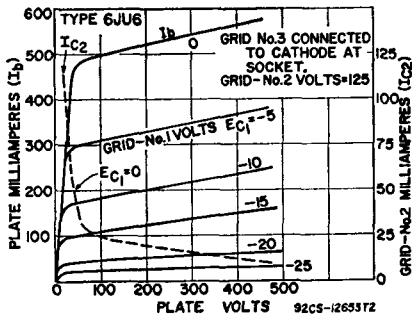
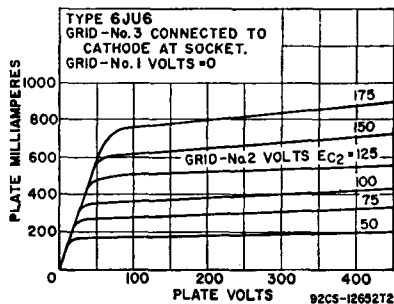

Refer to chart at end of section.

6JU8

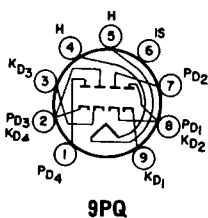

9PQ

QUADRUPLE DIODE

6JU8A

8JU8A

Miniature type used in phase-detector and noise-immune color-killer circuits of color television receivers, and in bridge-matrixing circuits in FM stereo multiplex equipment. Outlines section, 6B; requires miniature 9-contact socket. Units 1 and 2 are shielded from units 3 and 4 to minimize coupling between the series-connected pairs of diodes. Type 8JU8A is identical with type 6JU8A except for heater ratings.

Heater Voltage (ac/dc)	6JU8A 6.3	8JU8A 8.4	volts
Heater Current	0.6	0.45	ampere
Heater Warm-up Time	—	11	seconds
Peak Heater-Cathode Voltage	±300 max	±300 max	volts
Direct Interelectrode Capacitances (Approx.):			
Plate of Unit No.1 and Cathode of Unit No.2 to Cathode of Unit No.1		1.8	pF
Plate of Unit No.1 and Cathode of Unit No.2 to Plate of Unit No.2		2.2	pF
Plate of Unit No.2 to Heater and Internal Shield		0.62	pF
Plate of Unit No.3 and Cathode of Unit No.4 to Cathode of Unit No.3		1.9	pF
Plate of Unit No.3 and Cathode of Unit No.4 to Plate of Unit No.4		2.2	pF
Plate of Unit No.4 to Heater and Internal Shield		0.94	pF
Cathode of Unit No.1 to Heater and Internal Shield		1.8	pF
Cathode of Unit No.3 to Heater and Internal Shield		1.9	pF
MAXIMUM RATINGS (Design-Center Values, Each Diode Unit)			
Peak Inverse Plate Voltage		300	volts
Peak Plate Current		54	mA
Average Output Current		9	mA
CHARACTERISTIC, Instantaneous Value (Each Unit)			
Plate Current for plate voltage of 10 volts		60	mA

HIGH-MU TRIODE—
SHARP-CUTOFF PENTODE

6JV8

8JV8

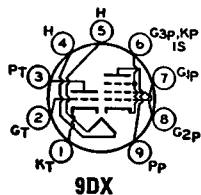

9DX

Miniature type used in television receiver applications, particularly those having low-voltage "B" supplies. The triode unit is used in sound-if, keyed-agc, sync-separator, sync-amplifier, and noise-suppression circuits. The pentode unit is especially useful as a video amplifier tube. Outlines section, 6E; requires miniature 9-contact socket. Type 8JV8 is identical with type 6JV8 except for heater ratings.

Heater Voltage (ac/dc)	6JV8 6.3	8JV8 8.5	volts
Heater Current	0.6	0.45	ampere
Heater Warm-up Time (Average)	11	11	seconds
Heater-Cathode Voltage:			
Peak value	±200 max	±200 max	volts
Average value	100 max	100 max	volts
Direct Interelectrode Capacitances (Approx.):			
Triode Unit:			
Grid to Plate		2.2	pF
Grid to Cathode and Heater		3	pF
Plate to Cathode and Heater		2	pF
Pentode Unit:			
Grid No.1 to Plate		0.08 max	pF
Grid No.1 to Cathode, Heater, Grid No.2, Grid No.3, and Internal Shield		8	pF

Plate to Cathode, Heater, Grid No.2, Grid No.3, and Internal Shield	3.2	pF
Pentode Grid No.1 to Triode Plate	0.012 max	pF
Pentode Plate to Triode Plate	0.24 max	pF

Class A₁ Amplifier

MAXIMUM RATINGS (Design-Maximum Values)	Triode Unit	Pentode Unit	
Plate Voltage	330	330	volts
Grid-No.2 (Screen-Grid) Voltage	—	330	volts
Grid-No.1 (Control-Grid) Voltage:			
Positive-bias value	0	0	volts
Negative-bias value	50	50	volts
Plate Dissipation	1.1	4	watts
Grid-No.2 Input	—	1.7	watts

CHARACTERISTIC	Triode Unit	Pentode Unit	
Plate Voltage	200	60	125
Grid-No.2 Voltage	—	200	125
Grid-No.1 Voltage	-2	0	-1
Amplification Factor	70	—	—
Plate Resistance (Approx.)	0.0175	—	0.1
Transconductance	4000	—	11500
Plate Current	4	51*	22
Grid-No.2 Current	—	14*	4
Grid-No.1 Voltage (Approx.) for plate current of 20 μ A	-5	—	-5.5
			-9

MAXIMUM CIRCUIT VALUES

Grid-No.1-Current Resistance:			
For fixed-bias operation	0.5	0.25	megohm
For cathode-bias operation	1	1	megohm

* This value can be measured by a method involving a recurrent waveform such that the maximum ratings of the tube will not be exceeded.

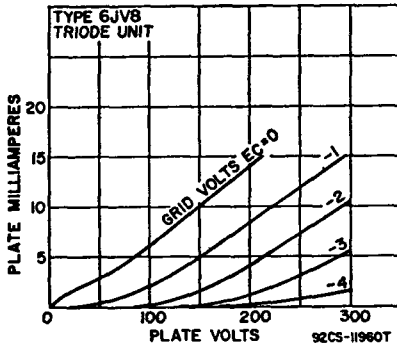

**6JW8/
ECF802**

5JW8
6LX8/LCF802
9JW8/PCF802

**MEDIUM-MU TRIODE—
SHARP-CUTOFF PENTODE**

Miniature type used as horizontal-oscillator and frequency-control tube in color and black-and-white television receivers. Outlines section, 6B; requires miniature 9-contact socket. Types 5JW8, 6LX8/LCF802 and 9JW8/PCF802 are identical with type 6JW8/ECF802 except for heater ratings.

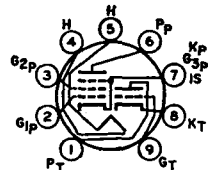

9AE

	5JW8	6JW8/ ECF802	6LX8/ LCF802	9JW8/ PCF802	
Heater Voltage (ac/dc) ..	4.7	6.3	6	9	volts
Heater Current	0.6	0.43	0.45	0.3	ampere
Heater Warm-up Time (Average)	11	—	—	—	seconds
Heater-Cathode Voltage:					
Peak value	± 200 max	± 200 max	± 200 max	± 200 max	volts
Average value	100 max	100 max	100 max	100 max	volts

Class A₁ Amplifier

MAXIMUM RATINGS (Design-Maximum Values)		Triode Unit	Pentode Unit	
Plate Supply Voltage	550	550	volts
Plate Voltage	250	250	volts
Grid-No.2 (Screen-Grid) Supply Voltage	—	550	volts
Grid-No.2 Voltage	—	250	volts
Peak Cathode Current*	—	60	mA
Cathode Current	10	15	mA
Plate Dissipation	1.4	1.2	watts
Grid-No.2 Input	—	0.8	watts
Input Impedance at 60 Hz	50	300	kohms

CHARACTERISTICS

Plate Voltage	200	100	volts
Grid-No.2 Voltage	—	100	volts
Grid-No.1 (Control-Grid) Voltage	-2	-1	volts
Mu Factor, Grid-No.1 to Grid-No.2	—	47	
Amplification Factor	70	—	
Input Resistance	0.2	0.4	megohm
Transconductance	3500	5500	μmhos
Plate Current	3.5	6	mA
Grid-No.2 Current	—	1.7	mA
Plate Current:				
For grid-No.1 voltage of 0 volts	—	12.5	mA
For grid current of 10 μA	10	—	mA
Grid-No.2 Current for grid-No.1 voltage of 0 volts	—	3.5	mA
Grid-No.1 Voltage:				
For grid-No.1 current of +0.3 μA	-1.3	-1.3	volts
For plate and grid-No.2 voltage of 200 volts and plate current of 10 μA	—	-16	volts

MAXIMUM CIRCUIT VALUES

Grid-No.1-Circuit Resistance:				
For fixed-bias operation	—	0.56	megohm
For cathode-bias operation	3	1	megohms

* With a maximum duty factor of 0.30 and maximum pulse duration of 30 microseconds.

Refer to chart at end of section.

6JZ6

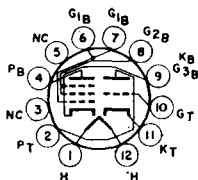

12DZ

heater ratings.

**MEDIUM-MU TRIODE—
POWER PENTODE**

6JZ8

13JZ8, 17JZ8, 24JZ8,
25JZ8

Duodecator type used in combined vertical-deflection-oscillator and vertical-deflection-amplifier applications in television receivers. Outlines section, 8C; requires duodecator 12-contact socket. Types 13JZ8, 17JZ8, 24JZ8, and 25JZ8 are identical with type 6JZ8 except for

	6JZ8	13JZ8	17JZ8	24JZ8	25JZ8	
Heater Voltage (ac/dc)	6.3	12.7	16.8	24.2	25.2	volts
Heater Current	1.2	0.6	0.45	0.315	0.3	amperes
Heater Warm-up Time	—	11	11	11	—	seconds
Heater-Cathode Voltage:						
Peak value	±200 max	±200 max	±200 max	±200 max	±200 max	volts
Average value	100 max	100 max	100 max	100 max	100 max	volts

Class A₁ Amplifier

CHARACTERISTICS	Triode Unit	Beam Power Unit	
Plate Voltage	150	45	120
Grid-No.2 (Screen-Grid) Voltage	—	110	110
Grid-No.1 (Control-Grid) Voltage	-5	0	-8
Amplification Factor	20	—	—
Plate Resistance (Approx.)	8500	—	11700
Transconductance	2350	—	7100
Plate Current	6.5	122*	46
Grid-No.2 Current	—	16.5*	3.5
Grid-No.1 Voltage (Approx.) for plate current of 10 μA	-10	—	—

Grid-No.1 Voltage (Approx.) for plate current of 100 μ A — — —25 volts

* This value can be measured by a method involving a recurrent waveform such that the maximum ratings of the tube will not be exceeded.

Vertical-Deflection Oscillator and Amplifier

For operation in a 525-line, 30-frame system

MAXIMUM RATINGS (Design-Maximum Values)	Triode Unit Oscillator	Beam Power Unit Amplifier	
DC Plate Voltage	250	250	volts
Peak Positive-Pulse Plate Voltage#	—	2000	volts
DC Grid-No.2 Voltage	—	200	volts
Peak Negative-Pulse Grid-No.1 Voltage	400	150	volts
Peak Cathode Current	70	245	mA
Average Cathode Current	20	70	mA
Plate Dissipation*	1	7	watts
Grid-No.2 Input	—	1.8	watts

MAXIMUM CIRCUIT VALUES

Grid-No.1-Circuit Resistance:			
For fixed-bias operation	1	1	megohm
For cathode-bias operation	2.2	2.2	megohms

Pulse duration must not exceed 15% of a vertical scanning cycle (2.5 milliseconds).

* A bias resistor or other means is required to protect the tube in absence of excitation.

6K5GT

Refer to chart at end of section.

6K6GT

POWER PENTODE

Glass octal type used in output stage of radio receivers and, triode-connected, as a vertical-deflection amplifier in television receivers. This type may be supplied with pin No.1 omitted. **Outlines section, 13D**; requires octal socket. This tube, like other power-handling tubes, should be adequately ventilated.

Heater Voltage (ac/dc)	6.3	volts
Heater Current	0.4	ampere
Heater-Cathode Voltage:		
Peak value	± 200 max	volts
Average value	100 max	volts
Direct Interelectrode Capacitances (Approx.):		
Grid No.1 to Plate	0.5	pF
Grid No.1 to Cathode, Heater, Grid No.2, and Grid No.3	5.5	pF
Plate to Cathode, Heater, Grid No.2, and Grid No.3	6	pF

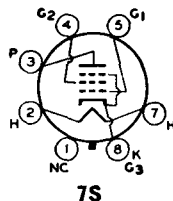

7S

Class A₁ Amplifier

MAXIMUM RATING (Design-Center Values)

Plate Voltage	315	volts
Grid-No.2 (Screen-Grid) Voltage	285	volts
Plate Dissipation	8.5	watts
Grid-No.2 Input	2.8	watts

TYPICAL OPERATION

Plate Voltage	100	250	315	volts
Grid-No.2 Voltage	100	250	250	volts
Grid-No.1 (Control-Grid) Voltage	-7	-18	-21	volts
Peak AF Grid-No.1 Voltage	7	18	21	volts
Zero-Signal Plate Current	9	32	25.5	mA
Maximum-Signal Plate Current	9.5	33	28	mA
Zero-Signal Grid-No.2 Current	1.6	5.5	4.0	mA
Maximum-Signal Grid-No.2 Current	3	10	9	mA
Plate Resistance (Approx.)	104000	90000	110000	ohms
Transconductance	1500	2300	2100	μ mhos
Load Resistance	12000	7600	9000	ohms
Total Harmonic Distortion	11	11	15	per cent
Maximum-Signal Power Output	0.35	3.4	4.5	watts

TYPICAL PUSH-PULL OPERATION (Values are for two tubes)

	Fixed Bias	Cathode Bias	
Plate Supply Voltage	285	285	volts
Grid-No.2 Supply Voltage	285	285	volts
Grid-No.1 Voltage	-25.5	—	volts
Cathode-Bias Resistor	—	400	ohms
Peak AF Grid-No.1-to-Grid-No.1 Voltage	51	51	volts
Zero-Signal Plate Current	55	55	mA
Maximum-Signal Plate Current	72	61	mA
Zero-Signal Grid-No.2 Current	9	9	mA
Maximum-Signal Grid-No.2 Current	17	13	mA
Effective Load Resistance (Plate-to-plate)	12000	12000	ohms
Total Harmonic Distortion	6	4	per cent
Maximum-Signal Power Output	10.5	9.8	watts

CHARACTERISTICS (Triode Connection)*

Plate Voltage	250	volts
Grid-No.1 Voltage	-18	volts
Plate Current	37.5	mA
Transconductance	2700	μmhos
Amplification Factor	6.8	
Plate Resistance (Approx.)	2500	ohms
Grid-No.1 Voltage (Approx.) for plate current of 0.5 mA	-48	volts

MAXIMUM CIRCUIT VALUES

Grid-No.1-Circuit Resistance:		
For fixed-bias operation	0.1	megohm
For cathode-bias operation	0.5	megohm

* Grid-No.2 connected to plate.

Vertical Deflection Amplifier (Triode Connection)*

For operation in a 525-line, 30-frame system

MAXIMUM RATINGS

DC Plate Voltage	315	volts
Peak Positive-Pulse Plate Voltage# (Absolute maximum)	1200°	volts
Peak Negative-Pulse Grid-No.1 Voltage	250	volts
Peak Cathode Current	75	mA
Average Cathode Current	25	mA
Plate Dissipation	7	watts

MAXIMUM CIRCUIT VALUE

Grid-No.1-Circuit Resistance, for cathode-bias operation	2.2	megohms
----------------------------------------------------------	-----	---------

* Grid No.2 connected to plate.

Pulse duration must not exceed 15% of a vertical scanning cycle (2.5 milliseconds).

° Under no circumstances should this absolute value be exceeded.

Refer to chart at end of section.

**6K7
6K7G
6K7GT**

Refer to chart at end of section.

**6K8
6K8G
6K8GT**

Refer to chart at end of section.

**6K11
6K11/6Q11**

6KA8

8KA8

HIGH-MU TRIODE— SHARP-CUTOFF PENTODE

Miniature type used in color and black-and-white television receivers. The triode unit is used in sync-separator circuits; the pentode unit has two independent control grids and is used in gated-agc-amplifier and noise-inverter circuits. **Outlines section, 6E**; requires miniature 9-contact socket. For curves of average plate characteristics for triode unit, refer to type 6AW8A. Type 8KA8 is identical with type 6KA8 except for heater ratings.

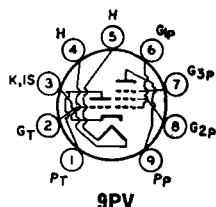

	6KA8	8KA8	
Heater Voltage (ac/dc)	6.3	8.4	volts
Heater Current	0.6	0.45	ampere
Heater Warm-up Time (Average)	11	11	seconds
Heater-Cathode Voltage:			
Peak value	±200 max	±200 max	volts
Average value	100 max	100 max	volts
Direct Interelectrode Capacitances:			
Triode Unit:			
Grid to Plate		2.2	pF
Grid to Cathode, Heater, and Internal Shield		2.8	pF
Plate to Cathode, Heater, and Internal Shield		2.2	pF
Pentode Unit:			
Grid No.1 to Plate		0.1 max	pF
Grid No.1 to Cathode, Heater, Grid No.2, Grid No.3, and Internal Shield		9.5	pF
Grid No.1 to Grid No.3		0.5	pF
Grid No.3 to Plate		2.2	pF
Grid No.3 to All Other Electrodes, Heater, and Internal Shield		7	pF

Class A₁ Amplifier

	Triode Unit	
MAXIMUM RATINGS (Design-Maximum Values)		
Plate Voltage	300	volts
Grid Voltage:		
Positive-bias value	0	volts
Negative-bias value	50	volts
Plate Dissipation	1.1	watts

	Triode Unit	Pentode Unit	
CHARACTERISTICS			
Plate Supply Voltage	200	150	volts
Grid-No.3 Supply Voltage	—	0	volts
Grid-No.2 Supply Voltage	—	100	volts
Grid-No.1 Supply Voltage	—2	0	volts
Cathode-Bias Resistor	—	180	ohms
Amplification Factor	70	—	
Plate Resistance (Approx.)	17500	100000	ohms
Transconductance, Grid No.1 to Plate	4000	4400	μmhos
Transconductance, Grid No.3 to Plate	—	600	μmhos
Plate Current	4	4	mA
Grid-No.2 Current	—	2.8	mA
Grid-No.1 Supply Voltage (Approx.):			
For plate current of 10 μA	—5	—	volts
For plate current of 20 μA	—	—4	volts
Grid No.3 Supply Voltage (Approx.) for plate current of 20 μA	—	—7	volts

	Triode Unit	
MAXIMUM CIRCUIT VALUES		
Grid-Circuit Resistance:		
For fixed-bias operation	0.25	megohm
For cathode-bias operation	1	megohm

Gated AGC Amplifier and Noise Inverter

	Pentode Unit	
MAXIMUM RATINGS (Design-Maximum Values)		
DC Plate Voltage	300	volts
Peak Positive-Pulse Plate Voltage#	600	volts
Grid-No.3 (Control-Grid) Voltage:		
Positive-bias value	0	volts
Negative-bias value	—100	volts
Grid-No.2 (Screen-Grid) Supply Voltage	300	volts
Grid-No.2 Voltage	See curve page 300	
Grid-No.1 (Control-Grid) Voltage:		
Positive-bias value	0	volts
Negative-bias value	—50	volts

Plate Dissipation	2	watts
Grid-No.2 Input:		
For grid-No.2 voltages up to 150 volts	1.1	watts
For grid-No.2 voltages between 150 and 300 volts	See curve page 300	

MAXIMUM CIRCUIT VALUES

Grid-No.3-Circuit Resistance	0.68	megohm
Grid-No.1-Circuit Resistance:		
For fixed-bias operation	0.5	megohm
For cathode-bias operation	1	megohm

Pulse duration must not exceed 15% of a horizontal scanning cycle (10 microseconds).

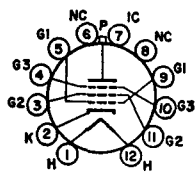
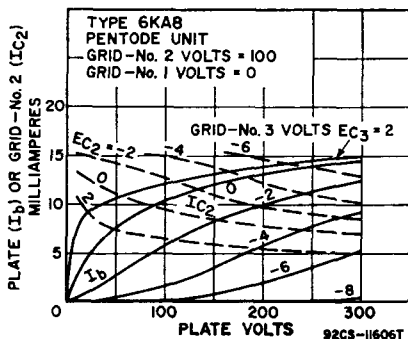
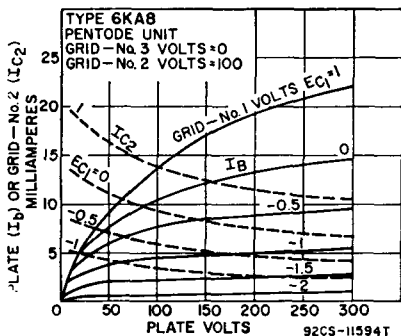

12GW

BEAM POWER TUBE

6KD6

30KD6, 36KD6/40KD6

Duodecator type used as horizontal-deflection amplifier in television receivers. Outlines section, 16C; requires duodecator 12-contact socket. Types 30KD6 and 36KD6/40KD6 are identical with type 6KD6 except for heater ratings.

	6KD6	30KD6	36KD6/40KD6	
Heater Voltage	6.3	30	36	volts
Heater Current	2.85	0.6	0.45	amperes
Heater Warm-up Time	—	11	11	seconds
Heater-Cathode Voltage:				
Peak value	±200 max	±200 max	±200 max	volts
Average value	100 max	100 max	100 max	volts
Direct Interelectrode Capacitances:				
Grid No.1 to Plate			0.8	pF
Grid No.1 to Cathode, Heater, Grid No.2, and Grid No.3			40	pF
Plate to Cathode, Heater, Grid No.2, and Grid No. 3			16	pF

Horizontal-Deflection Amplifier

For operation in a 525-line, 30-frame system

MAXIMUM RATINGS (Design-Maximum Values)

DC Plate Supply Voltage	990	volts
Peak Positive-Pulse Plate Voltage#	7000	volts
Positive DC Grid-No.3 Voltage	20	volts
Grid-No.2 Voltage	200	volts
Peak Negative-Pulse Grid-No.1 Voltage	250	volts
Peak Cathode Current	1400	mA
Average Cathode Current	400	mA
Plate Dissipation*	33	watts
Grid-No.2 Input	5	watts
Bulb Temperature (At hottest point)	225	°C

Class A₁ Amplifier

CHARACTERISTICS

	Triode† Connection	Pentode Connection	
Plate Voltage	150	60 150	volts
Grid No.3 (Suppressor Grid)		Connected to cathode at socket	

Grid-No.2 (Screen-Grid) Voltage	150	110	110	volts
Grid-No.1 (Control-Grid) Voltage	-22.5	0	-22.5	volts
Amplification Factor	4	—	—	
Plate Resistance (Approx.)	—	—	6000	ohms
Transconductance	—	—	14000	μmhos
Plate Current	—	750**	120	mA
Grid-No.2 Current	—	42**	1.8	mA
Grid-No.1 Voltage (Approx.) for plate current of 1.0 μA	—	—	-40	volts

MAXIMUM CIRCUIT VALUE

Grid-No.1-Circuit Resistance	2.2	megohms
Grid-No.3-Circuit Resistance	0.01	megohm

* A bias resistor or other means is required to protect the tube in absence of excitation.
 # Pulse duration must not exceed 15% of a horizontal scanning cycle (10 microseconds).

‡ Grid-No.2 connected to plate at socket.

** This value can be measured by a method involving a recurrent waveform such that the maximum ratings of the tube will not be exceeded.

6KD8

For replacement use type 6U8A/6KD8.

6KE8

4KE8, 5KE8

**MEDIUM-MU TRIODE—
SHARP-CUTOFF PENTODE**

Miniature type with frame-grid pentode unit used as combined oscillator-mixer tube in television receivers using an intermediate frequency in the order of 40 MHz. Outlines section, 6B; requires miniature 9-contact socket. Types 4KE8 and 5KE8 are identical with type 6KE8 except for heater ratings.

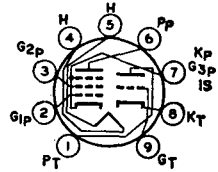
**9DC**

	4KE8	5KE8	6KE8	
Heater Voltage (ac/dc)	4.5	5.6	6.3	volts
Heater Current	0.6	0.45	0.4	ampere
Heater Warm-up Time (Average)	11	11	—	seconds
Heater-Cathode Voltage:				
Peak value	±200 max	±200 max	±200 max	volts
Average value	100 max	100 max	100 max	volts
Direct Interelectrode Capacitances:†				
Triode Unit:				
Grid to Plate			1.3	pF
Grid to Cathode, Heater, Pentode Cathode, Pentode Grid No.3, and Internal Shield			2.4	pF
Plate to Cathode, Heater, Pentode Cathode, Pentode Grid No.3, and Internal Shield			2	pF
Pentode Unit:				
Grid No.1 to Plate			0.015 max	pF
Grid No.1 to Cathode, Heater, Grid No.2, Grid No.3, and Internal Shield			5	pF
Plate to Cathode, Heater, Grid No.2, Grid No.3, and Internal Shield			3.4	pF
Heater to Triode Cathode and Pentode Cathode			5.5*	pF

† With external shield connected to cathode of unit under test, except as noted.

* With external shield connected to ground.

Class A₁ Amplifier

MAXIMUM RATINGS (Design-Maximum Values)	Triode Unit	Pentode Unit	
Plate Voltage	280	280	volts
Grid-No.2 (Screen-Grid) Supply Voltage	—	280	volts
Grid-No.2 Voltage	—	See curve page 300	
Grid-No.1 (Control-Grid) Voltage, Positive-bias value	0	0	volts
Cathode Current	20	20	mA
Plate Dissipation	2	2	watts
Grid-No.2 Input:			
For grid-No.2 voltages up to 140 volts	—	0.5	watt
For grid-No.2 voltages between 140 and 280 volts	—	See curve page 300	

CHARACTERISTICS

Plate Supply Voltage	125	125	volts
Grid-No.2 Supply Voltage	—	125	volts
Grid-No.1 Supply Voltage	0	0	volts
Cathode-Bias Resistor	68	33	ohms
Amplification Factor	40	—	
Plate Resistance (Approx.)	5000	125000	ohms
Transconductance	8000	12000	μmhos

Plate Current	18	10	mA
Grid-No.2 Current	—	2.8	mA
Grid-No.1 Voltage (Approx.):			
For plate current of 100 μ A	5	—	volts
For plate current of 50 μ A	—	-3	volts
MAXIMUM CIRCUIT VALUES			
Grid-No.1-Circuit Resistance:			
For fixed-bias operation	0.5	0.25	megohm
For cathode-bias operation	1	0.5	megohm

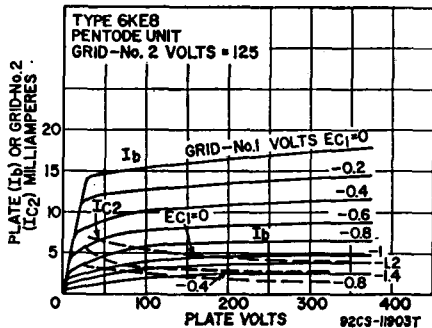
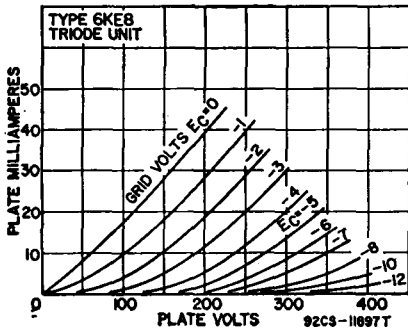

POWER PENTODE

6KG6A/
EL509

40KG6A/PL509

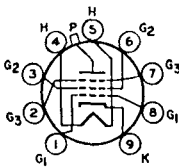

9RJ

Magnaol type used as a horizontal-deflection amplifier in color television receivers. Outlines section, 38A; requires 9-contact magnaol socket. Type 40KG6A/PL509 is identical with type 6KG6A/EL509 except for heater ratings.

Heater Voltage (ac/dc)	6.3	40	volts
Heater Current	2	0.3	amperes
Peak Heater-Cathode Voltage		250	volts
Direct Interelectrode Capacitances:			
Plate to Grid-No.1	2.5		pF
Grid-No.1 to Heater	0.2		pF

Class A₁ Amplifier

CHARACTERISTICS

Plate Voltage	45	160	volts
Grid-No.3 Voltage	0	0	volts
Grid-No.2 Voltage	160	160	volts
Grid-No.1 Voltage	0	0	volts
Plate Current*	1000 (min.)	1400	mA
Grid-No.2 Current*	—	45	mA

Horizontal-Deflection Amplifier

For operation in a 525-line, 30-frame system

MAXIMUM RATINGS (Design-Maximum Values)

Plate Supply Voltage	700	volts
Peak Positive-Pulse Plate Voltage*	7000	volts
Grid-No.2 Voltage (zero-current)	700	volts
Grid-No.2 Voltage	250	volts
Plate Dissipation (Absolute-Maximum Value)	34	watts
Grid-No.2 Input	7	watts
Cathode Current	500	mA

MAXIMUM CIRCUIT VALUES

Grid-No.1-Circuit Resistance:

For fixed-bias operation	0.25	megohm
For cathode-bias operation	2.2	megohms

‡ In horizontal-deflection service, 15 volts may be applied to grid-No.3 to minimize snivets.

* These values can be measured by a method involving a recurrent waveform such that the maximum ratings of the tube will not be exceeded.

* Pulse duration must not exceed 15% of a horizontal scanning cycle (10 microseconds).

6KL8

Refer to chart at end of section.

6KM6

22KM6

BEAM POWER TUBE

Novar type used as horizontal-deflection amplifier in color and black-and-white television receivers. Outlines section, 18A; requires novar 9-contact socket. Type 22KM6 is identical with type 6KM6 except for heater ratings.

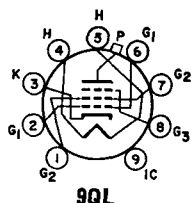

Heater Voltage (ac/dc)	6KM6 6.3	22KM6 22	volts
Heater Current	1.6	0.45	amperes
Heater Warm-up Time	—	11	seconds
Heater-Cathode Voltage:			
Peak value	±200 max	±200 max	volts
Average value	100 max	100 max	volts
Direct Interelectrode Capacitances:			
Grid No.1 to Plate		1.2	pF
Grid No.1 to Cathode, Heater, Grid No.2, and Grid No.3		22	pF
Plate to Cathode, Heater, Grid No.2, and Grid No.3		9	pF

Class A₁ Amplifier

CHARACTERISTICS

	Triode Connection	Pentode Connection		
Plate Voltage	140	60	140	volts
Peak Positive-Pulse Plate Voltage**	—	6500	—	volts
Grid-No.3 (Suppressed-Grid) Voltage	0	30	30	volts
Grid-No.2 (Screen-Grid) Voltage	140	140	140	volts
Grid-No.1 (Control-Grid) Voltage	-24.5	0	-24.5	volts
Amplification Factor†	4	—	—	
Plate Resistance (Approx.)	—	—	6000	ohms
Transconductance	—	—	9500	μmhos
Plate Current	—	560††	80	mA
Grid-No.2 Current	—	31††	2.4	mA
Grid-No.1 Voltage for plate current of 1 mA	—	-110	-42	volts

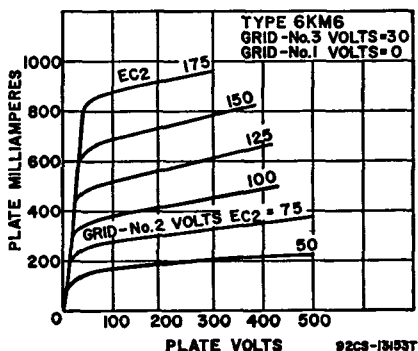
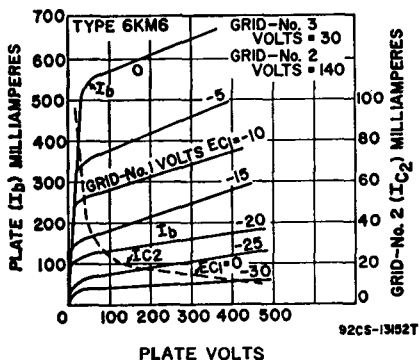

Horizontal-Deflection Amplifier

For operation in a 525-line, 30-frame system

MAXIMUM RATINGS (Design-Maximum Values)

DC Plate Supply Voltage	770	volts
Peak Positive-Pulse Plate Voltage#	6500	volts
Peak Negative-Pulse Plate Voltage	1500	volts
DC Grid-No.3 Voltage*	75	volts
DC Grid-No.2 Voltage	220	volts
Peak Negative-Pulse Grid-No.1 Voltage	330	volts
Peak Cathode Current	950	mA
Average Cathode Current	275	mA
Grid-No.2 Input	3.5	watts
Plate Dissipation**	20	watts
Bulb Temperature (At hottest point)	240	°C

MAXIMUM CIRCUIT VALUES

Grid-No.1-Circuit Resistance:		
For grid-resistor-bias operation	0.47	megohm
For plate-pulsed operation	10	megohms

Pulse duration must not exceed 15% of a horizontal scanning cycle (10 microseconds).

† With grid No.3 and grid No.2 connected, respectively, to cathode and plate at socket.

‡‡ This value can be measured by a method involving a recurrent waveform such that the maximum ratings of the tube will not be exceeded.

* In this service, a positive value may be applied to grid No.3 to minimize "snivets" interference; a typical value for this voltage is 30 volts.

** A bias resistor or other means is required to protect the tube in absence of excitation.

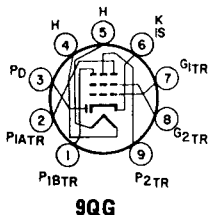

**DIODE—SHARP-CUTOFF
THREE-PLATE TETRODE**

6KM8

Miniature type used in frequency-divider and complex-wave generator circuits of electronic musical instruments. In such circuits the tetrode unit can provide three independent output-signal voltages; the diode unit can be used as a key in a vibrato circuit. Outlines section, 6E; requires miniature 9-contact socket.

Heater Voltage (ac/dc)	6.3	volts
Heater Current	0.3	ampere
Heater-Cathode Voltage:		
Peak value	±200 max	volts
Average value	100 max	volts
Direct Interelectrode Capacitances:		
Tetrode Unit:		
Grid No.1 to Plate No.1A	0.02 max	pF
Grid No.1 to Plate No.1B	0.02 max	pF
Grid No.1 to Plate No.2	0.06 max	pF
Grid No.1 to Cathode, Heater, Grid No.2, and Internal Shield	5.5	pF
Plate No.1A to Cathode, Heater, Grid No.2, and Internal Shield	1.2	pF
Plate No.1B to Cathode, Heater, Grid No.2, and Internal Shield	1.3	pF
Plate No.2 to Cathode, Heater, Grid No.2, and Internal Shield	1.8	pF
Tetrode Grid No.1 to Diode Plate	0.024 max	pF
Tetrode Plate No.1A to Diode Plate	0.18	pF
Tetrode Plate No.1B to Diode Plate	0.024	pF
Tetrode Plate No.2 to Diode Plate	0.013	pF

Tetrode Unit as Class A₁ Amplifier

Plates No. 1A, 1B, and 2 connected together

CHARACTERISTICS

Plate Voltage	100	volts
Grid-No.2 Voltage	100	volts
Grid-No.1 Supply Voltage	0	volts
Grid-No.1 Resistor (Bypassed)	2.2	megohms
Plate Resistance (Approx.)	30000	ohms
Transconductance	3400	μmhos
Plate Current	4.2	mA
Grid-No.2 Current	1.7	mA
Grid-No.1 Voltage (Approx.) for plate current of 20 μA	-4	volts

Triode Connection—Plates No.1A, 1B, and 2 connected to grid No.2

Plate Voltage	100	volts
Grid-No.1 Supply Voltage	0	volts
Grid-No.1 Resistor (Bypassed)	2.2	megohms
Transconductance	4500	μ mhos
Amplification Factor	45	
Plate Current	5.5	mA

Separate-plate operation; plates not under test grounded

Plate	1A	1B	2	
Plate Voltage	100	100	100	volts
Grid-No.2 Voltage	100	100	100	volts
Grid-No.1 Supply Voltage	0	0	0	volts
Grid-No.1 Resistor (Bypassed)	2.2	2.2	2.2	megohms
Transconductance	2000	2000	1800	μ mhos
Plate Resistance (Approx.)	0.1	0.1	0.12	megohm
Plate Current	2.3	2.3	2.1	mA
Grid-No.2 Current	3.8	3.8	3.3	mA

Tetrode Unit as Frequency Divider and Complex-Wave Generator

MAXIMUM RATINGS (Design-Maximum Values)

Plate Voltage (Each plate)	330	volts
Grid-No.2 (Screen-Grid) Supply Voltage	330	volts
Grid-No.2 Voltage	See curve page 300	
Grid-No.1 (Control-Grid) Voltage:		
Positive-bias value	0	volts
Negative-bias value	50	volts
Plate Dissipation (Each plate)	1	watt
Grid-No.2 Input:		
For grid-No.2 voltages up to 165 volts	0.65	watt
For grid-No.2 voltages between 165 and 330 volts	See curve page 300	

MAXIMUM CIRCUIT VALUE

Grid-No.1-Circuit Resistance, for grid-No.1-resistor-bias operation	2.2	megohms
---------------------------------------------------------------------	-----	---------

Diode Unit

MAXIMUM RATINGS (Design-Maximum Values)

Plate Current	1	mA
CHARACTERISTICS, Instantaneous Value		
Tube Voltage Drop for plate current of 2 mA	10	volts

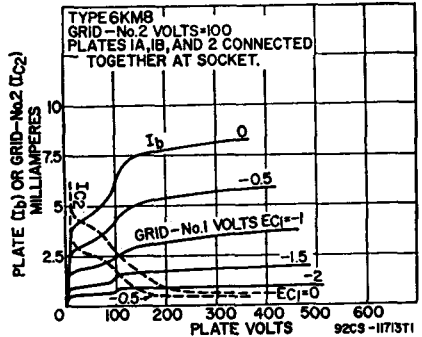
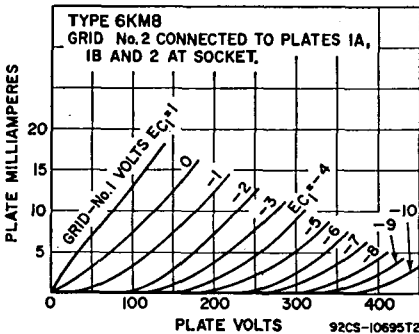

6KN6

42KN6

BEAM PENTODE

Duodec type used as horizontal-deflection amplifier in color and black-and-white television receivers. Out-lines section, 39B; requires duodec 12-contact socket. Type 42KN6 is identical with type 6KN6 except for heater ratings.

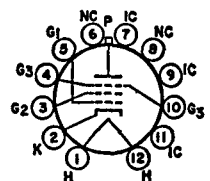

12GU

	6KN6 Parallel	42KN6 Series	
Heater Arrangement			
Heater Voltage	6.3	42	volts
Heater Current	3	0.45	ampere
Heater Warm-up Time	—	11	seconds
Heater-Cathode Voltage:			
Peak value	±200 max	±200 max	volts
Average value	100 max	100 max	volts

Class A₁ Amplifier

CHARACTERISTICS	Triode* Connection		Pentode Connection		
	Plate Voltage	130	5500	60	
Grid-No.2 (Screen-Grid) Voltage	130	125	125	130	volts
Grid-No.1 (Control-Grid) Voltage	-20	—	0	-20	volts
Plate Resistance	—	—	—	4000	ohms
Transconductance	—	—	—	16000	μmhos
Plate Current	—	—	800 ^A	100	mA
Grid-No.2 Current	—	—	50 ^A	4	mA
Grid-No.1 Voltage (Approx.) for plate current of 1 mA	—	—	—	-33	volts
Grid-No.1 Voltage (Approx.) for plate current of 75 μA	—	100	—	—	volts
Amplification Factor	4.5	—	—	—	

^A This value can be measured by a method involving a recurrent waveform such that the maximum ratings of the tube will not be exceeded.

* Grid No.2 connected to plate.

Horizontal-Deflection Amplifier

For operation in a 525-line, 30-frame system

MAXIMUM RATINGS (Design-Maximum Values)

DC Plate Supply Voltage	770	volts
Peak Positive-Pulse Plate Voltage#	6500	volts
Peak Negative-Pulse Plate Voltage	1500	volts
Grid-No.2 Voltage	220	volts
Peak Negative-Pulse Grid-No.1 Voltage	330	volts
Average Cathode Current	400	mA
Peak Cathode Current	1500	mA
Plate Dissipation*	30	watts
Grid-No.2 Input	5	watts
Bulb Temperature (At hottest point)	260	°C

MAXIMUM CIRCUIT VALUE

Grid-No.1-Circuit Resistance	1	megohm
------------------------------------	---	--------

Pulse duration must not exceed 15% of one horizontal scanning cycle (10 microseconds).

* A bias resistor or other means is required to protect the tube in absence of excitation.

Refer to chart at end of section.

6KN8/6RHH8

**MEDIUM-MU TRIODE—
SHARP-CUTOFF PENTODE**

6KR8

10KR8

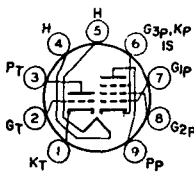

9DX

Miniature type used in television receiver applications. The triode unit is used as a general-purpose amplifier; the pentode unit is used as a video amplifier. Outlines section, 6E; requires miniature 9-contact socket. Type 10KR8 is identical with type 6KR8 except for heater ratings.

	6KR8	10KR8	
Heater Voltage (ac/dc)	6.3	10.5	volts
Heater Current	0.75	0.45	ampere
Heater Warm-up Time (Average)	—	11	seconds
Heater-Cathode Voltage:			
Peak value	±200 max	±200 max	volts
Average value	100 max	100 max	volts

Class A₁ Amplifier

MAXIMUM RATINGS (Design-Maximum Values)

	Triode Unit	Pentode Unit	
Plate Voltage	—	330	volts
Grid-No.2 (Screen-Grid) Supply Voltage	330	330	volts
Grid-No.2 Voltage	—	See curve page 300	
Grid-No.1 (Control-Grid) Voltage, Positive-bias value	0	0	volts
Plate Dissipation	2	5	watts
Grid-No.2 Input:			
For voltages up to 165 volts	—	1.1	watts
For voltages between 165 and 330 volts	—	See curve page 300	

CHARACTERISTICS

	Triode Unit	Pentode Unit		
Plate Supply Voltage	125	35	200	volts
Grid-No.2 Supply Voltage	—	100	100	volts
Grid-No.1 Voltage	—	0	—	volts
Cathode-Bias Resistor	68	—	82	ohms
Amplification Factor	46	—	—	
Plate Resistance (Approx.)	4400	—	60000	ohms
Transconductance	10400	—	20000	μmhos
Plate Current	15	54	19.5	mA
Grid-No.2 Current	—	13.5	3	mA
Grid-No.1 Voltage (Approx.) for plate current of 10 μA	-8	—	—	volts
Grid-No.1 Voltage (Approx.) for plate current of 100 μA	—	—	-6.3	volts

MAXIMUM CIRCUIT VALUES

	Triode Unit	Pentode Unit	
Grid-No.1-Circuit Resistance:			
For fixed-bias operation	0.5	0.5	megohm
For cathode-bias operation	1	1	megohm

6KS6

For replacement use type 6BN6/6KS6.

6KT6

3KT6, 4KT6

SEMIREMOTE-CUTOFF
PENTODE

Miniature type with frame grid used as if-amplifier tube in television receivers utilizing an intermediate frequency in the order of 40 MHz. Outlines section, 6B; requires miniature 9-contact socket. Types 3KT6 and 4KT6 are identical with type 6KT6 except for heater ratings.

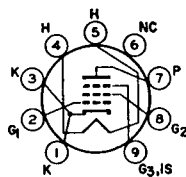

9PM

	3KT6	4KT6	6KT6	
Heater Voltage (ac/dc)	3.5	4.5	6.3	volts
Heater Current	0.6	0.45	0.3	ampere
Heater Warm-up Time (Average)	11	11	—	seconds
Heater-Cathode Voltage:				
Peak value	±200 max	±200 max	±200 max	volts
Average value	100 max	100 max	100 max	volts
Direct Interelectrode Capacitances:				
Grid No.1 to Plate			0.019 max	pF
Grid No.1 to Cathode, Heater, Grid No.2, Grid No.3, and Internal Shield			9.5	pF
Plate to Cathode, Heater, Grid No.2, Grid No.3, and Internal Shield			3	pF

Class A₁ Amplifier

MAXIMUM RATINGS (Design-Maximum Values)

Plate Voltage	330	volts
Grid-No.3 (Suppressor-Grid) Voltage	0	volts
Grid-No.2 (Screen-Grid) Supply Voltage	330	volts
Grid-No.2 Voltage	See curve page 300	
Grid-No.1 (Control-Grid) Voltage	0	volts
Plate Dissipation	3.1	watts
Grid-No.2 Input:		
For grid-No.2 voltages up to 165 volts	0.6	watt
For grid-No.2 voltages between 165 and 330 volts	See curve page 300	

CHARACTERISTICS

Plate Supply Voltage	125	170	volts
Grid-No.3 Voltage	0	0	volts
Grid-No.2 Supply Voltage	125	170	volts
Cathode-Bias Resistor	56	56	ohms
Plate Resistor	160000	—	ohms
Transconductance	18000	—	μ mhos
Plate Current	17	—	mA
Grid-No.2 Current	4.2	—	mA
Grid-No.1 Voltage (Approx.) for transconductance of 10 μ mhos	—	-22	volts

MAXIMUM CIRCUIT VALUES

Grid-No.1-Circuit Resistance:			
For fixed-bias operation	—	0.25	megohm
For cathode-bias operation	—	1	megohm

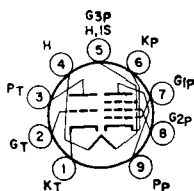
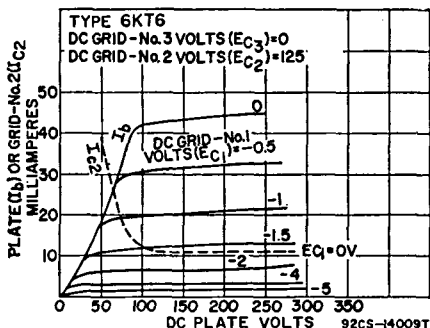

9QP

**HIGH-MU TRIODE—
SHARP-CUTOFF PENTODE**

6KT8

Miniature type used in color and black-and-white television receiver applications. The pentode unit is used as an if-amplifier tube, and the triode unit as a sync-separator or voltage-amplifier tube. Outlines section, 6B; requires miniature 9-contact socket.

Heater Voltage (ac/dc)	6.3	volts	
Heater Current	0.6	ampere	
Heater-Cathode Voltage:			
Peak value	± 200 max	volts	
Average value	100 max	volts	
Direct Interelectrode Capacitances:			
Triode Unit:	Unshielded	Shielded	
Grid to Plate	3	3	pF
Grid to Cathode, Heater, Grid No.3 of Pentode Unit, and Internal Shield	3.2	3.2	pF
Plate to Cathode, Heater, Grid No.3 of Pentode Unit, and Internal Shield	1.6	2.4	pF
Pentode Unit:			
Grid No.1 to Plate	0.046 max	0.030 max	pF
Grid No.1 to Cathode, Heater, Grid No.2, Grid No.3, and Internal Shield	7.5	7.5	pF
Plate to Cathode, Heater, Grid No.2, Grid No.3, and Internal Shield	2.2	2.8	pF
Grid of Triode Unit to Plate of Pentode Unit	0.018 max	0.003 max	pF
Grid No.1 of Pentode Unit to Plate of Triode Unit	0.006 max	0.002 max	pF

Class A₁ Amplifier

MAXIMUM RATINGS (Design-Maximum Values)

Plate Voltage	330	330	volts
Grid-No.2 (Screen-Grid) Supply Voltage	—	330	volts
Grid-No.2 Voltage			See curve page 300

Grid-No.1 (Control-Grid) Voltage, Positive-bias value	0	0	volts
Plate Dissipation	1	2.5	watts
Grid-No.2 Input:			
For grid-No.2 voltages up to 165 volts	—	0.55	watt
For grid-No.2 voltages between 165 and 330 volts	—	See curve page 300	

CHARACTERISTICS

Plate Voltage	250	125	volts
Grid-No.2 Voltage	—	125	volts
Grid-No.1 Voltage	—2	—1	volts
Amplification Factor	100	—	
Plate Resistance (Approx.)	31500	150000	ohms
Transconductance	3200	10000	μmhos
Plate Current	1.8	12	mA
Grid-No.2 Current	—	4.5	mA
Grid-No.1 Voltage (Approx.) for plate current of 20 μA	—3.5	—7	volts

MAXIMUM CIRCUIT VALUES

Grid-No.1-Circuit Resistance:			
For fixed-bias operation	0.5	0.5	megohm
For cathode-bias operation	1	1	megohm

6KU8 Refer to chart at end of section.

6KV6 Refer to chart at end of section.

6KV6A

17KV6A, 22KV6A

BEAM POWER TUBE

Novar type used for high-voltage pulse- or shunt-regulator applications in color television receivers. Outlines section, 31D; requires novar 9-contact socket. Types 17KV6A and 22KV6A are identical with type 6KV6A except for heater ratings.

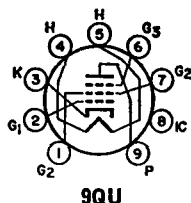

9QU

	6KV6A	17KV6A	22KV6A	
Heater Voltage (ac/dc)	6.3	16.8	22	volts
Heater Current	1.6	0.6	0.45	amperes
Heater Warm-up Time	—	11	11	seconds
Heater-Cathode Voltage:				
Peak value	+200 max	+200 max	+200 max	volts
Average value	—500 max	—500 max	—500 max	volts
100 max	100 max	100 max	100 max	volts
Direct Interelectrode Capacitances (Approx.):				
Grid No.1 to Plate		0.6		pF
Grid No.1 to Cathode, Heater, Grid No.2, and Grid No.3		22		pF
Plate to Cathode, Heater, Grid No.2, and Grid No.3		9		pF

Class A₁ Amplifier

CHARACTERISTICS

Plate Voltage	100	140	volts
Grid-No.3 (Suppressor-Grid) Voltage	0	0	volts
Grid-No.2 (Screen-Grid) Voltage	140	140	volts
Grid-No.1 (Control-Grid) Voltage	0	—24.5	volts
Triode Amplification Factor#	—	4	
Plate Resistance (Approx.)	—	10000	ohms
Transconductance	—	6000	μmhos
Plate Current	440 ^m	40	mA
Grid-No.2 Current	30 ^m	2.4	mA
Grid-No.1 Voltage for plate current of 1 mA	—	—42	volts

High-Voltage-Pulse Shunt Regulator

For operation in a 525-line, 30-frame system

MAXIMUM RATINGS (Design-Maximum Values)

DC Plate Supply Voltage (I _b = 0 mA)	900	volts
Peak Positive-Pulse Plate Voltage ^A	6500	volts

Peak Negative-Pulse Plate Voltage	1500	volts
Peak Positive-Pulse Grid-No.2 Voltage	600	volts
DC Grid-No.3 Voltage	75	volts
DC Grid-No.2 Voltage	220	volts
DC Grid-No.1 Voltage, Negative-bias value	250	volts
Peak Negative-Pulse Grid-No.1 Voltage	330	volts
Peak Cathode Current	950	mA
Average Cathode Current	275	mA
Plate Dissipation †	28*	watts
Grid-No.2 Input	2	watts
Bulb Temperature (At hottest point)	240	°C

MAXIMUM CIRCUIT VALUE

Grid-No.1-Circuit Resistance:
 For grid-No.1-resistor-bias operation 1 megohm

Grid-No.3 and grid-No.2 connected, respectively, to cathode and plate at socket.

* This value can be measured by a method involving a recurrent waveform such that the maximum ratings of the tube will not be exceeded.

† Pulse duration must not exceed 15% of a horizontal scanning cycle (10 microseconds).

‡ Adequate circuit precautions must be taken to protect the tube in the absence of grid-No.1 bias.

• Plate dissipations up to 32 watts maximum are permissible for short periods of time provided the maximum envelope-temperature rating is not exceeded. This condition may exist under high-line voltage, zero picture tube beam current.

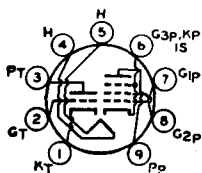

9DX

**HIGH-MU TRIODE—
SHARP-CUTOFF PENTODE**

**6KV8
11KV8**

Miniature type with frame-grid pentode unit used in black-and-white television receivers. The triode unit is used in general-purpose voltage-amplifier, sync-separator, and sound-if-amplifier applications. The pentode unit is used as a video-output tube. Outlines section, 6E; requires miniature 9-contact socket. For curves of

average plate characteristics for triode unit, refer to type 6AW8A. Type 11KV8 is identical with type 6KV8 except for heater ratings.

Heater Voltage (ac/dc)	6KV8 6.3	11KV8 10.9	volts
Heater Current	0.775	0.45	ampere
Heater Warm-up Time (Average)	—	11	seconds
Heater-Cathode Voltage:			
Peak value	±200 max	±200 max	volts
Average value	100 max	100 max	volts

Direct Interelectrode Capacitances (Approx.):

Triode Unit:			
Grid to Plate		3.7	pF
Grid to Cathode, Heater, Pentode Cathode, Pentode Grid No.3, and Internal Shield		2.5	pF
Plate to Cathode, Heater, Pentode Cathode, Pentode Grid No.3, and Internal Shield		2.4	pF
Triode Grid to Pentode Plate		0.015 max	
Pentode Unit:			
Grid No.1 to Plate		0.12 max	pF
Grid No.1 to Cathode, Heater, Grid No.2, Grid No.3, and Internal Shield		13	pF
Plate to Cathode, Heater, Grid No.2, Grid No.3, and Internal Shield		4.8	pF
Pentode Plate to Triode Plate		0.17 max	pF

Class A₁ Amplifier

MAXIMUM RATINGS (Design-Maximum Values)	Triode Unit	Pentode Unit	
Plate Voltage	300	300	volts
Grid-No.2 (Screen-Grid) Supply Voltage	—	300	volts
Grid-No.2 Voltage	—	See curve page 300	
Grid-No.1 (Control-Grid) Voltage, Positive-bias value	0	0	volts
Plate Dissipation	1	5	watts
Grid-No.2 Input:			
For Grid-No.2 voltages up to 150 volts	—	1	watt
For Grid-No.2 voltages between 150 and 300 volts	—	See curve page 300	

CHARACTERISTICS

	Triode Unit	Pentode Unit		
Plate Supply Voltage	200	125	200	volts
Grid-No.2 Supply Voltage	—	125	125	volts
Grid-No.1 Supply Voltage	—2	0	0	volts
Cathode-Bias Resistor	—	82	68	ohms
Amplification Factor	70	—	—	
Plate Resistance (Approx.)	17500	55000	75000	ohms
Transconductance	4000	21000	23000	μmhos
Plate Current	4	16.5	20	mA
Grid-No.2 Current	—	3.1	3.5	mA
Grid-No.1 Voltage (Approx.) for plate current of 100 μA	—4.5	—4.2	—4.2	volts

MAXIMUM CIRCUIT VALUES

Grid-No.1-Circuit Resistance:	Triode Unit	Pentode Unit	
For fixed-bias operation	0.5	0.1	megohm
For cathode-bias operation	1	0.25	megohm

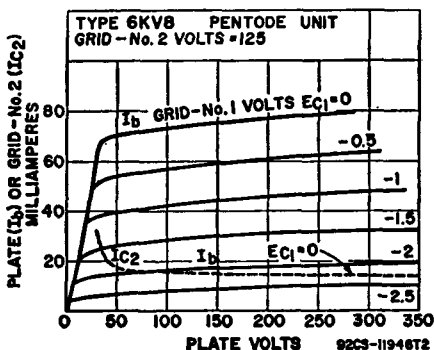

6KY6

Refer to chart at end of section.

6KY8

Refer to chart at end of section.

6KY8A

15KY8A

**HIGH-MU TRIODE—
BEAM POWER TUBE**

Novar type used in combined vertical-deflection-oscillator and vertical-deflection-amplifier applications in black-and-white television receivers having low-voltage "B" supplies. Outlines section, 30A; requires novar 9-contact socket. Type 15KY8A is identical with type 6KY8A except for heater ratings.

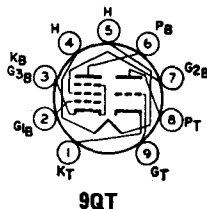

	6KY8A	15KY8A	
Heater Voltage (ac/dc)	6.3	15	volts
Heater Current	1.1	0.45	amperes
Heater Warm-up Time (Average)	—	11	seconds

Heater Cathode Voltage:	6KY8A	15KY8A	
Peak value	±200 max	±200 max	volts
Average value	100 max	100 max	volts

Direct Interelectrode Capacitances (Approx.):

Triode Unit:		
Grid to Plate	0.44	pF
Grid to Cathode and Heater	16	pF
Plate to Cathode and Heater	7	pF
Pentode Unit:		
Grid No.1 to Plate	0.048	pF
Grid No.1 to Cathode, Heater, Grid No.2, and Grid No.3	2.6	pF
Plate to Cathode, Heater, Grid No.2, and Grid No.3	0.28	pF

Class A₁ Amplifier

CHARACTERISTICS

	Triode Unit		Beam Power Unit		
Plate Voltage	250	50	135	120	volts
Grid-No.2 (Screen-Grid) Voltage	—	120	120	*	volts
Grid-No.1 (Control-Grid) Voltage	-3	0	-10	-10	volts
Amplification Factor	64	—	—	7	
Plate Resistance (Approx.)	40000	—	18000	—	ohms
Transconductance	1600	—	8400	—	μmhos
Plate Current	1.4	170*	39	—	mA
Grid-No.2 Current	—	20*	3	—	mA
Grid-No.1 Voltage (Approx.) for plate current of 1 mA	—	—	-24	—	volts

- * Triode connection, grid No.2 connected to plate at socket.
- * This value can be measured by a method involving a recurrent waveform such that the maximum ratings of the tube will not be exceeded.

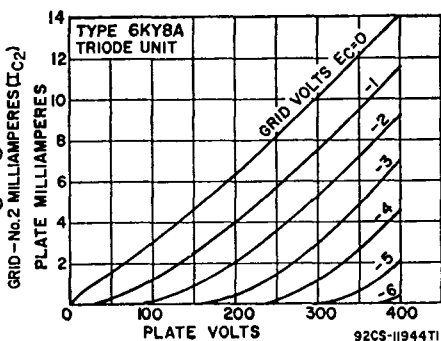
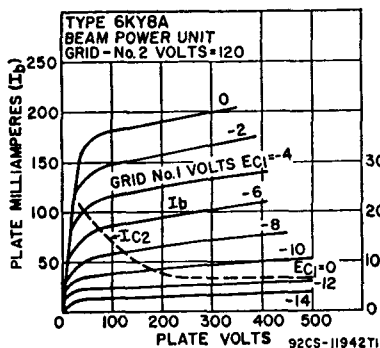

Vertical-Deflection Oscillator and Amplifier

For operation in a 525-line, 30-frame system

MAXIMUM RATINGS (Design-Maximum Values)

	Triode Unit Oscillator	Beam Power Unit Amplifier	
DC Plate Voltage	330	300	volts
Peak Positive-Pulse Plate Voltage# (Absolute Maximum)	—	2200†	volts
DC Grid-No.2 Voltage	—	150	volts
Peak Negative-Pulse Grid-No.1 Voltage	400	250	volts
Peak Cathode Current	77	200	mA
Average Cathode Current	22	60	mA
Plate Dissipation	1.5	12	watts
Grid-No.2 Input	—	1.9	watts

MAXIMUM CIRCUIT VALUES

Grid-No.1-Circuit Resistance: For grid-resistor-bias operation	2.2	2.2	megohms
-------------------------------------------------------------------	-----	-----	---------

Pulse duration must not exceed 15% of a vertical scanning cycle (2.5 milliseconds).

† Under no conditions should this maximum value be exceeded.

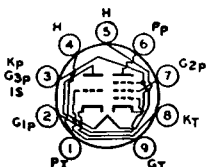

9FZ

**MEDIUM-MU TRIODE—
SHARP-CUTOFF PENTODE**

6KZ8

5KZ8, 9KZ8

Miniature type used as combined oscillator and mixer in vhf color and black-and-white television receivers. Outlines section, 6B; requires miniature 9-contact socket. Types 5KZ8 and 9KZ8 are identical with type 6KZ8 except for heater ratings.

	5KZ8	6KZ8	9KZ8	
Heater Voltage (ac/dc)	4.7	6.3	9.45	volts
Heater Current	0.6	0.45	0.3	ampere
Heater Warm-up Time (Average)	11	11	11	seconds
Heater-Cathode Voltage:				
Peak value	±200 max	±200 max	±200 max	volts
Average value	100 max	100 max	100 max	volts

Direct Interelectrode Capacitances:*

Triode Unit:			
Grid to Plate		1.6	pF
Grid to Triode Cathode, Pentode Cathode, Heater, Pentode Grid No.3, and Heater		3.2	pF
Plate to Triode Cathode, Pentode Cathode, Heater, Pentode Grid No.3, and Heater		1.8	pF
Pentode Unit:			
Grid No.1 to Plate		0.01 max	pF
Grid No.1 to Cathode, Heater, Grid No.2, Grid No.3, and Internal Shield		5.5	pF
Plate to Cathode, Heater, Grid No.2, Grid No.3, and Internal Shield		3.4	pF
Heater to Cathode (Each Unit)		3.2#	pF

* With external shield connected to cathode.

With external shield connected to ground.

Class A₁ Amplifier

MAXIMUM RATINGS (Design-Maximum Values)

	Triode Unit	Pentode Unit	
Plate Voltage	330	330	volts
Grid-No.2 (Screen-Grid) Supply Voltage	—	330	volts
Grid-No.2 Voltage	—	See curve page 300	
Grid No.1 (Control-Grid) Voltage, Positive-bias value	0	0	volts
Plate Dissipation	2.5	2.5	watts
Grid-No.2 Input:			
For grid-No.2 voltages up to 165 volts	—	0.55	watt
For grid-No.2 voltages between 165 and 330 volts	—	See curve page 300	

CHARACTERISTICS

Plate Voltage	125	125	volts
Grid-No.2 Voltage	—	125	volts
Grid-No.1 Voltage	—1	—1	volt
Amplification Factor	46	—	
Plate Resistance (Approx.)	5400	20000	ohms
Transconductance	8500	7500	μmhos
Plate Current	13.5	12	mA
Grid-No.2 Current	—	4	mA
Grid-No.1 Voltage (Approx.) for plate current of 10 μA			
	—8	—8	volts

MAXIMUM CIRCUIT VALUES

	Triode Unit	Pentode Unit	
Grid-No.1-Circuit Resistance:			
For fixed-bias operation	0.25	0.25	megohm
For cathode-bias operation	0.5	0.5	megohm

6L5G

Refer to chart at end of section.

6L6
6L6GC

BEAM POWER TUBE

Metal type 6L6 and glass octal type 6L6GC are used in the output stage of audio amplifying equipment, especially units designed to have ample reserve of power-delivering ability. Outlines section, 4 and 19D, respectively; require octal socket. These tubes, like other power-handling tubes, should be adequately ventilated. Type 6L6GC can be used in place of type 6L6 and may be supplied with pin 1 omitted.

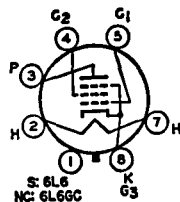

7AC

Heater Voltage (ac/dc)		6.3	volts
Heater Current		0.9	ampere
Heater-Cathode Voltage:	6L6	6L6GC	
Peak value	±180 max	±200 max	volts
Average value	—	100 max	volts
Direct Interelectrode Capacitances (Approx.):			
Grid No.1 to Plate	0.4*	0.6	pF
Grid No.1 to Cathode, Heater, Grid No.2, and Grid No.3	10*	10	pF
Plate to Cathode, Heater, Grid No.2, and Grid No.3	12*	6.5	pF

* With pin 1 connected to pin 8.

Class A₁ Amplifier

MAXIMUM RATINGS	6L6	6L6GC	
	Design-Center Values	Design Maximum Values	
Plate Voltage	360	500	volts
Grid-No.2 (Screen-Grid) Voltage	270	450 ^A	volts
Plate Dissipation	19	30	watts
Grid-No.2 Input	2.5	5	watts

TYPICAL OPERATION

Plate Voltage	250	300	350	volts
Grid-No.2 Voltage	250	200	250	volts
Grid-No.1 (Control-Grid) Voltage	-14	-12.5	-18	volts
Peak AF Grid-No.1 Voltage	14	12.5	18	volts
Zero-Signal Plate Current	72	48	54	mA
Maximum-Signal Plate Current	79	55	66	mA
Zero-Signal Grid-No.2 Current	5	2.5	2.5	mA
Maximum-Signal Grid-No.2 Current	7.3	4.7	7	mA
Plate Resistance (Approx.)	22500	35000	33000	ohms
Transconductance	6000	5300	5200	μmhos
Load Resistance	2500	4500	4200	ohms
Total Harmonic Distortion	10	11	15	per cent
Maximum-Signal Power Output	6.5	6.5	10.8	watts

^A In push-pull circuits where grid No.2 of each tube is connected to a tap on the plate winding of the output transformer, this maximum rating is 500 volts.

Class A₁ Amplifier (Triode Connection)†

MAXIMUM RATINGS	6L6	6L6GC	
	Design-Center Values	Design-Maximum Values	
Plate Voltage	275	450	volts
Plate Dissipation (Total)	19	30	watts

TYPICAL OPERATION

Plate Voltage		250	volts
Grid-No.1 Voltage		-20	volts
Peak AF Grid-No.1 Voltage		20	volts
Zero-Signal Plate Current		40	mA
Maximum-Signal Plate Current		44	mA
Plate Resistance (Approx.)		1700	ohms
Amplification Factor		8	
Transconductance		4700	μmhos
Load Resistance		5000	ohms
Total Harmonic Distortion		5	per cent
Maximum-Signal Power Output		1.4	watts

† Grid No.2 connected to plate.

Push-Pull Class A₁ Amplifier

MAXIMUM RATINGS (Same as for Class A₁ Amplifier)

TYPICAL OPERATION (Values are for two tubes)

Plate Voltage	250	270	volts
Grid-No.2 Voltage	250	270	volts
Grid-No.1 Voltage	-16	-17.5	volts
Peak AF Grid-No.1-to-Grid-No.1 Voltage	32	35	volts
Zero-Signal Plate Current	120	134	mA
Maximum-Signal Plate Current	140	155	mA
Zero-Signal Grid-No.2 Current	10	11	mA
Maximum-Signal Grid-No.2 Current	16	17	mA
Effective Load Resistance (Plate-to-plate)	5000	5000	ohms
Total Harmonic Distortion	2	2	per cent
Maximum-Signal Power Output	14.5	17.5	watts

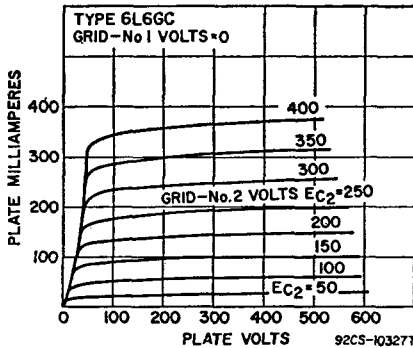

Push-Pull Class AB₁ Amplifier

MAXIMUM RATINGS (Same as for Class A₁ Amplifier)

TYPICAL OPERATION (Values are for two tubes)

	6L6	6L6GC	
Plate Voltage	360	360	450 volts
Grid-No.2 Voltage	270	270	400 volts
Grid-No.1 Voltage	-22.5	-22.5	-37 volts
Peak AF Grid-No.1-to-Grid-No.1 Voltage	45	45	70 volts
Zero-Signal Plate Current	88	88	116 mA
Maximum-Signal Plate Current	132	140	210 mA
Zero-Signal Grid-No.2 Current	5	5	5.6 mA
Maximum-Signal Grid-No.2 Current	15	11	22 mA
Effective Load Resistance (Plate-to-plate)	6600	3800	5600 ohms
Total Harmonic Distortion	2	2	1.8 per cent
Maximum-Signal Power Output	26.5	18	55 watts

Push-Pull Class AB₂ Amplifier

MAXIMUM RATINGS (Same as for Class A₁ Amplifier)

TYPICAL OPERATION (Values are for two tubes)

	6L6	6L6GC	
Plate Voltage	360	360	450 volts
Grid-No.2 Voltage	270	270	400 volts
Grid-No.1 Voltage	-18	-22.5	-37 volts
Peak AF Grid-No.1-to-Grid-No.1 Voltage	52	72	70 volts
Zero-Signal Plate Current	78	88	116 mA
Maximum-Signal Plate Current	142	205	210 mA
Zero-Signal Grid-No.2 Current	3.5	5	5.6 mA
Maximum-Signal Grid-No.2 Current	11	16	22 mA
Effective Load Resistance (Plate-to-plate)	6000	3800	5600 ohms
Total Harmonic Distortion	2	2	1.8 per cent
Maximum-Signal Power Output	31	47	55 watts

MAXIMUM CIRCUIT VALUES

Grid-No.1-Circuit Resistance:		
For fixed-bias operation	0.1	megohm
For cathode-bias operation	0.5	megohm

6L6G Refer to chart at end of section.

6L6GB Refer to chart at end of section.

6L7 Refer to chart at end of section.

6L7G Refer to chart at end of section.

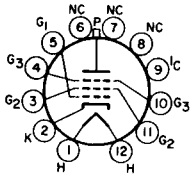

12JF

BEAM POWER TUBE

6LB6

Duodecar type used as horizontal-deflection amplifier in color and black-and-white television receivers. Outlines section, 16E; requires duodecar 12-contact socket.

Heater Voltage (ac/dc)	6.3	volts
Heater Current	2.25	amperes
Heater-Cathode Voltage:		
Peak value	±200 max	volts
Average value	100 max	volts
Direct Interelectrode Capacitances:		
Grid No.1 to Plate	0.44	pF
Grid No.1 to Cathode, Heater, Grid No.2, and Grid No.3	33	pF
Plate to Cathode, Heater, Grid No.2, and Grid No.3	18	pF

Class A₁ Amplifier

CHARACTERISTICS	Triode* Connection		Pentode Connection		
	—	125	5000	50	
Peak Positive-Pulse Plate Voltage	—	125	5000	50	volts
Plate Voltage	—	125	5000	150	volts
Grid-No.3 (Suppressor Grid)	—	—	Connected to cathode at socket		
Grid-No.2 Voltage	—	125	110	110	volts
Grid-No.1 Voltage	—	-25	—	-20	volts
Plate Resistance (Approx.)	—	—	—	6600	ohms
Transconductance	—	—	—	13400	μmhos
Plate Current	—	—	560‡	105	mA
Grid-No.2 Current	—	—	46‡	2	mA
Grid-No.1 Voltage (Approx.) for plate current of 1 mA	—	—	-125	-40	volts
Amplification Factor	—	4	—	—	

* Grid No.2 tied to plate.

‡ This value may be measured by a method involving a recurrent waveform such that the maximum ratings of the tube will not be exceeded.

Horizontal-Deflection Amplifier

For operation in a 525-line, 30-frame system

MAXIMUM RATINGS (Design-Maximum Values)

DC Plate Supply Voltage	990	volts
Peak Positive Pulse Plate Voltage# (Absolute Maximum Value)	7000	volts
Peak Negative-Pulse Plate Voltage	100	volts
Grid-No.3 Voltage, Positive-bias value	0	volts
Grid-No.2 Voltage	200	volts
Peak Negative Grid-No.1 Voltage	300	volts
Peak Cathode Current	1100	mA
Average Cathode Current	315	mA
Plate Dissipation* (Absolute Maximum Value)	30	watts
Grid-No.2 Input	5	watts
Bulb Temperature (At hottest point)	200	°C

MAXIMUM CIRCUIT VALUES

Grid-No.1-Circuit Resistance:		
With feedback-type high voltage regulation	1.2	megohms
With shunt-type high voltage regulation (switching mode)	10	megohms
Grid-No.3-Circuit Resistance	0	ohms

Pulse duration must not exceed 15% of a horizontal scanning cycle (10 microseconds).

* A bias resistor or other means is required to protect the tube in absence of excitation.

Refer to chart at end of section.

6LB8

6LC8

8LC8

HIGH-MU TRIODE— SHARP-CUTOFF PENTODE

Miniature type used in color and black-and-white television receiver applications. Pentode unit is used in noise-immune gated-agc-amplifier circuits, and the triode unit in sync-separator circuits. Outlines section, 6E; requires miniature 9-contact socket. Type 8LC8 is identical with type 6LC8 except for heater ratings. For curves of average plate characteristics, refer to type 6KA8.

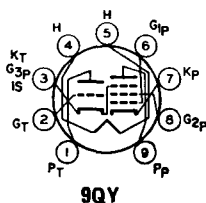

	6LC8	8LC8	
Heater Voltage (ac/dc)	6.3	8.4	volts
Heater Current	0.6	0.45	ampere
Heater Warm-up Time (Average)	11	11	seconds
Heater-Cathode Voltage:			
Peak value	±200 max	±200 max	volts
Average value	100 max	100 max	volts
Direct Interelectrode Capacitances:			
Triode Unit:			
Grid to Plate		2.2	pF
Grid to Cathode, Heater, Pentode Grid No.3, and Internal Shield		2.8	pF
Plate to Cathode, Heater, Pentode Grid No.3, and Internal Shield		2.2	pF
Pentode Unit:			
Grid No.1 to Plate		0.10 max	pF
Grid No.1 to Cathode, Heater, Grid No.3, Triode Cathode, and Internal Shield		10	pF
Grid No.3, Triode Cathode, and Internal Shield to Plate		3.4	pF
Grid No.1 to Grid No.3, Triode Cathode, and Internal Shield		0.36	pF
Grid No.3, Triode Cathode, and Internal Shield to Plate, Cathode, Heater, Grid No.1, and Grid No.2		12.5	pF

Class A₁ Amplifier

	Triode Unit	Pentode Unit	
MAXIMUM RATINGS (Design-Maximum Values)			
Plate Voltage	300		volts
Grid Voltage:			
Positive-bias value	0		volts
Negative-bias value	50		volts
Plate Dissipation	1.1		watts
CHARACTERISTICS			
Plate Supply Voltage	200	150	volts
Grid-No.2 Supply Voltage	—	100	volts
Grid-No.1 Voltage	—2	—	volts
Cathode-Bias Resistor	—	180	ohms
Amplification Factor	70	—	
Plate Resistance (Approx.)	17500	100000	ohms
Transconductance, Grid No.1 to Plate	4000	4400	μmhos
Transconductance, Grid No.3 to Plate	—	600	μmhos
Plate Current	4	4	mA
Grid-No.2 Current	—	2.8	mA
Grid-No.1 Voltage (Approx.):			
For plate current of 10 μA	—5	—	volts
For plate current of 20 μA	—	—4	volts
Grid-No.3 Voltage (Approx.) for plate current of 20 μA	—	—7*	volts

MAXIMUM CIRCUIT VALUES

	Triode Unit	
Grid-Circuit Resistance:		
For fixed-bias operation	0.25	megohm
For cathode-bias operation	1	megohm

* With no external connection to triode plate and triode grid.

Gated AGC Amplifier and Noise Inverter

For operation in a 525-line, 30-frame system

	Pentode Unit	
MAXIMUM RATINGS (Design-Maximum Values)		
DC Plate Voltage	300	volts
Peak Positive-Pulse Plate Voltage#	600	volts
Grid-No.3 (Control-Grid) Voltage:		
Positive-bias value	0	volts
Negative-bias value	100	volts
Grid-No.2 (Screen-Grid) Supply Voltage	300	volts
Grid-No.2 Voltage	See curve page 300	
Grid-No.1 (Control-Grid) Voltage:		
Positive-bias value	0	volts
Negative-bias value	50	volts

Plate Dissipation	2	watts
Grid-No.2 Input:		
For grid-No.2 voltages up to 150 volts	1.1	watts
For grid-No.2 voltages between 150 and 300 volts	See curve	page 300

MAXIMUM CIRCUIT VALUES

Grid-No.1-Circuit Resistance:		
For fixed-bias operation	0.5	megohm
For cathode-bias operation	1	megohm

Pulse duration must not exceed 15% of a horizontal scanning cycle (10 microseconds).

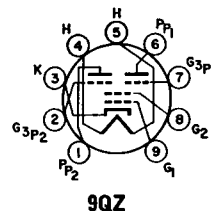

9QZ

TWIN PENTODE

6LE8

10LE8, 15LE8

Miniature type used as combined color demodulator and matrix amplifier in color television receivers utilizing high-level demodulation systems. Outlines section, 6G; requires miniature 9-contact socket. Types 10LE8 and 15LE8 are identical with type 6LE8 except for heater ratings.

Heater Voltage (ac/dc)	6LE8	10LE8	15LE8	
Heater Current	6.3	10.0	15.0	volts
Heater Warm-up Time (Average)	0.76	0.45	0.3	ampere
Heater-Cathode Voltage:				seconds
Peak value		+200, -300	max	volts
Average value		+100		volts
Direct Interelectrode Capacitances:				
Plate (Each Unit) to All Other Electrodes			3.7	pF
Grid No.1 to All Other Electrodes			15.5	pF
Grid No.3 (Each Unit) to All Other Electrodes			6	pF
Grid No.3 to Plate (Each Unit)			2.7	pF
Grid No.3 (Unit No.1) to Grid No.3 (Unit No.2)			0.1	pF

Class A₁ Amplifier

MAXIMUM RATINGS (Design-Maximum Values)

Plate Voltage (Each Unit)	300	volts
Grid-No.2 (Screen-Grid) Voltage	150	volts
Plate Dissipation (Each Unit)	2	watts
Grid-No.2 Input	2	watts

CHARACTERISTICS

	G₁ Control	G₂ Control	
Plate Voltage	100	100	volts
Grid-No.3 (Suppressor-Grid) Voltage	0	0	volts
Grid-No.2 Voltage	100	100	volts
Grid-No.1 (Control-Grid) Voltage, Negative-bias value	2.5	2.5	volts
Transconductance (Approx.)	5800	350	μmhos
Plate Resistance (Approx.)	50000	50000	ohms
Plate Current	8	7.6	mA
Grid-No.2 Current	15	14.5	mA
Grid-No.1 Voltage for plate current of 20 μA	-7.2	—	volts
Grid-No.1 Voltage for plate current of 100 μA	-6.3	—	volts
Grid-No.3 Voltage for plate current of 20 μA	—	-17.4	volts
Grid-No.3 Voltage for plate current of 100 μA	—	-16.5	volts

For replacement use type 6LF6/6LX6.

6LF6

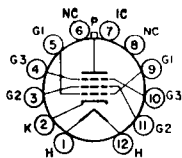

12WV

BEAM POWER TUBE

6LF6/6LX6

20LF6

Duodecax type used as horizontal deflection amplifier in color television receivers. Outlines section, 16F; requires duodecax 12-contact socket. Type 20LF6 is identical with type 6LF6/6LX6 except for heater ratings.

	6LF6/ 6LX6	20LF6	
Heater Voltage (ac/dc)	6.3	20	volts
Heater Current	2.0	0.6	ampere
Peak Heater-Cathode Voltage	±275 max	±200 max	volts

Class A₁ Amplifier

CHARACTERISTICS

Plate Voltage	50	160	volts
Grid-No.3 (Suppressor-Grid) Voltage	0	0	volts
Grid-No.2 (Screen-Grid) Voltage	175	160	volts
Grid-No.1 (Control-Grid) Voltage	-10	0	volts
Plate Current	800	1400	mA
Grid-No.2 Current	70	45	mA

Horizontal-Deflection Amplifier

For operation in a 525-line, 30-frame system

MAXIMUM RATINGS (Design-Maximum Values)

Plate Voltage	990	volts
Peak Positive-Pulse Plate Voltage#	8000	volts
Plate Dissipation	40	watts
Grid-No.3 Voltage	50	volts
Grid-No.2 Voltage	275	volts
Grid-No.2 Input	9	watts
Beam Plates Circuit Resistor	10000	ohms
Peak Negative-Pulse Grid-No.1 Voltage	550	volts
Bulb Temperatures	300	°C

Pulse duration must not exceed 22% of a horizontal scanning cycle (18 microseconds).

6LF8

HIGH-MU TRIODE— SHARP-CUTOFF PENTODE

Miniature type used in video-amplifier stages of color and black-and-white television receivers. Outlines section, 6E; requires miniature 9-contact socket.

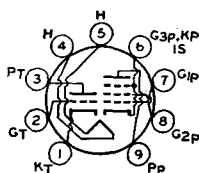

9DX

Heater Voltage (ac/dc)	6.3	volts
Heater Current	0.6	ampere
Heater Warm-up Time (Average)	11	seconds
Heater-Cathode Voltage:		
Peak value	±200 max	volts
Average value	100 max	volts

Direct Interelectrode Capacitances:

Triode Unit:		
Grid to Plate	2.2	pF
Grid to Cathode, Heater, Pentode Cathode, Pentode Grid No.3, and Internal Shield	3.2	pF
Plate to Cathode, Heater, Pentode Cathode, Pentode Grid No.3, and Internal Shield	1.8	pF
Pentode Unit:		
Grid No.1 to Plate	0.06 max	pF
Grid No.1 to Cathode, Heater, Grid No.2, Grid No.3, and Internal Shield	10	pF
Plate to Cathode, Heater, Grid No.2, Grid No.3, and Internal Shield	3.6	pF
Pentode Grid No.1 to Triode Plate	0.008 max	pF
Pentode Plate to Triode Plate	0.15 max	pF

Class A Amplifier

MAXIMUM RATINGS (Design-Maximum Values)

	Triode Unit	Pentode Unit	
Plate Voltage	330	330	volts
Grid-No.2 (Screen-Grid) Supply Voltage	—	330	volts
Grid-No.2 Voltage	—	See curve page 300	
Grid-No.1 (Control-Grid) Voltage:			
Positive-bias value	4	0	volts
Negative-bias value	-55	-55	volts
Grid-No.1 Current	8	0	mA
Plate Dissipation	1.1	3.75	watts
Grid-No.2 Input:			
For grid-No.2 voltages up to 165 volts	—	1.1	watts
For grid-No.2 voltages between 165 and 330 volts	—	See curve page 300	

CHARACTERISTICS

Plate Voltage	200	40	75	100	volts
Grid-No.2 Voltage	—	—	150	150	volts
Grid-No.1 Voltage	-2	3	0	-2.5	volts
Amplification Factor	70	40	—	—	
Plate Resistance (Approx.)	17500	10000	—	200000	ohms
Transconductance	4000	4000	—	11000	μmhos
Plate Current	4	11	50*	20	mA
Grid-No.2 Current	—	—	12*	5	mA
Grid-No.1 Current	0	2.7	0	0	mA
Grid-No.1 Voltage (Approx.) for plate current of 20 μA	-5	—	—	-8	volts

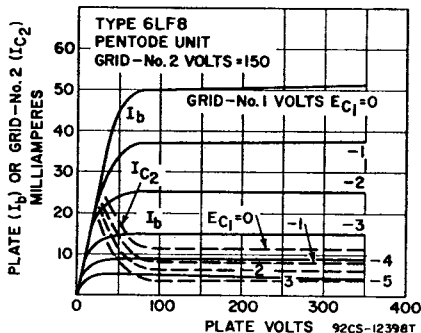
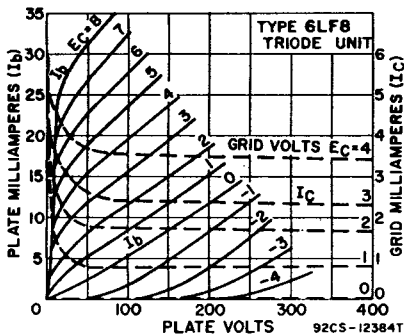

MAXIMUM CIRCUIT VALUES

Grid-No.1-Circuit Resistance:	
For fixed-bias operation	0.5 megohm
For cathode-bias operation	1 megohm

Triode Unit	Pentode Unit	
0.5	0.25	megohm
1	1	megohm

* This value can be measured by a method involving a recurrent waveform such that the maximum ratings of the tube will not be exceeded.

Refer to chart at end of section.

For replacement use type 6LJ6A/6LH6A.

Refer to chart at end of section.

6LH6A

6LJ6

**6LJ6A/
6LH6A**

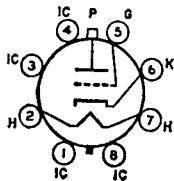

8MQ

BEAM TRIODE

Glass octal type used for the shunt regulation of high-voltage, low-current power supplies in color and black-and-white television receivers. Outlines section, 21D; requires octal socket. For high-voltage and X-ray safety considerations, refer to page 93.

Heater Voltage (ac/dc)	6.3	volts
Heater Current	0.2	ampere
Heater Cathode Voltage	+ not recommended, -450*	volts
Direct Interelectrode Capacitances:		
Grid to Plate	1	pF
Grid to Cathode and Heater	2.6	pF
Plate to Cathode and Heater	1	pF

* Series impedance should be used with the cathode to limit the cathode current under prolonged short-circuit conditions to 450 mA.

Shunt Voltage-Regulator Service

MAXIMUM RATINGS (Design-Maximum Values)

Plate Voltage	27000	volts
Negative Grid Voltage	135	volts
Peak Negative Grid Voltage*	440	volts
Plate Dissipation	40	watts
Average Plate Current	1.5	mA

TYPICAL OPERATION

Unregulated DC Supply Voltage	36000	volts
Equivalent Resistance of Unregulated Supply	11	megohms

DC Reference Voltage	200	volts
Equivalent Resistance of Reference Supply	1000	ohms
Effective Grid-Plate Transconductance	200	μ mhos
DC Plate Current for Load Current of 0 mA	1000	μ A
DC Plate Current for Load Current of 1 mA	45	μ A
Regulated DC Output Voltage for Load Current of 0 mA	25000	volts
Regulated DC Output Voltage for Load Current of 1 mA	24500	volts

MAXIMUM CIRCUIT VALUE

Grid-Circuit Resistance:

For use with "Flyback Transformer" high voltage supply 3 megohms

X-RADIATION CHARACTERISTIC

X-Radiation, Maximum:

Statistical value controlled on a lot sampling basis 0.5 mR/hr

* For interval of 20 seconds maximum during equipment warm-up period.

Caution—Operation of this tube outside of the maximum values indicated above may result in either temporary or permanent changes in the X-radiation characteristic of the tube. Equipment design must be such that these maximum values are not exceeded.

6LJ8

4LJ8, 5LJ8

**MEDIUM-MU TRIODE—
SHARP-CUTOFF PENTODE**

Miniature type used as a combined oscillator and mixer in vhf television receivers. Outlines section, 6B; requires 9-contact socket. Types 4LJ8 and 5LJ8 are identical with type 6LJ8 except for heater ratings.

	4LJ8	5LJ8	6LJ8	
Heater Voltage (ac/dc)	4.3	5.6	6.3	volts
Heater Current	0.6	0.45	0.4	ampere
Heater Warm-up Time (Average)	11	11	—	seconds
Heater-Cathode Voltage:				
Peak value	± 200 max	± 200 max	± 200 max	volts
Average value	100 max	100 max	100 max	volts

Class A₁ Amplifier**MAXIMUM RATINGS (Design-Maximum Values)**

	Triode Unit	Pentode Unit	
Plate Voltage	280	280	volts
Grid-No.2 (Screen-Grid) Supply Voltage	—	280	volts
Grid-No.2 Voltage	—	See curve page 300	
Cathode Current	20	20	mA
Grid-No.1 (Control-Grid) Voltage, Positive-bias value	0	0	volts
Plate Dissipation	2	2	watts
Grid-No.2 Input:			
For grid-No.2 voltages up to 140 volts	—	0.5	watts
For grid-No.2 voltages between 140 and 280 volts	—	See curve page 300	

CHARACTERISTICS

Plate Voltage	125	125	volts
Grid-No.2 Voltage	—	125	volts
Cathode-Bias Resistor	68	33	ohms
Amplification Factor	40	—	
Plate Resistance (Approx.)	5000	125000	ohms
Transconductance	8000	13000	μ mhos
Plate Current	13	12	mA
Grid-No.2 Current	—	3.5	mA
Grid-No.1 Voltage (Approx.) for plate current of 30 μ A	-6.5	-4	volts

MAXIMUM CIRCUIT VALUES

Grid-No.1-Circuit Resistance:

For fixed-bias operation 1 megohm

For cathode-bias operation 0.5 megohm

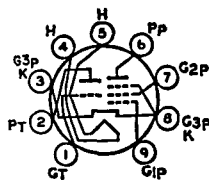
**9GF****6LM8****MEDIUM-MU TRIODE—SEMI-
REMOTE-CUTOFF PENTODE**

Miniature type used in color and black-and-white television receiver applications. The pentode unit is used in burst-amplifier circuits, and the triode unit as a general-purpose amplifier tube. Outlines section, 6B; requires miniature 9-contact socket.

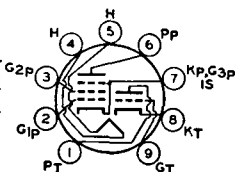
**9AE**

Heater Voltage (ac/dc)	6.3	volts
Heater Current	0.45	ampere
Heater-Cathode Voltage:		
Peak value	±200 max	volts
Average value	100 max	volts
Direct Interelectrode Capacitances:		
Triode Unit:		
Grid to Plate	1.8	pF
Grid to Cathode, Heater, Pentode Cathode, Pentode Grid No.3, and Internal Shield	3.2	pF
Plate to Cathode, Heater, Pentode Cathode, Pentode Grid No.3, and Internal Shield	1.9	pF
Pentode Unit:		
Grid No.1 to Plate	0.015 max	pF
Grid No.1 to Cathode, Heater, Grid No.2, Grid No.3, and Internal Shield	5.5	pF
Plate to Cathode, Heater, Grid No.2, Grid No.3, and Internal Shield	3.8	pF
Heater to Cathode (Each Unit)	3.2	pF

Class A₁ Amplifier

MAXIMUM RATINGS (Design-Maximum Values)

	Triode Unit	Pentode Unit	
Plate Voltage	330	350	volts
Grid-No.2 (Screen-Grid) Supply Voltage	—	330	volts
Grid-No.2 Voltage	—	See curve page 300	
Grid-No.1 (Control-Grid) Voltage, Positive-bias value	0	0	volts
Plate Dissipation	2.5	2.5	volts
Grid-No.2 Input:			
For grid-No.2 voltages up to 165 volts	—	0.55	watts
For grid-No.2 voltages between 165 and 330 volts	—	See curve page 300	

CHARACTERISTICS

Plate Voltage	125	125	volts
Grid-No.2 Voltage	—	125	volts
Grid No.1 Voltage	-1	-2	volts
Amplification Factor	46	—	
Plate Resistance (Approx.)	5400	15000	ohms
Transconductance	8500	6000	μmhos
Plate Current	13.5	12	mA
Grid-No.2 Current	—	4	mA
Grid-No.1 Voltage (Approx.) for plate current of 10 μA	-8	-14	volts

MAXIMUM CIRCUIT VALUES

Grid-No.1-Circuit Resistance:			
For fixed-bias operation	0.5	0.25	megohm
For cathode-bias operation	1	0.5	megohm

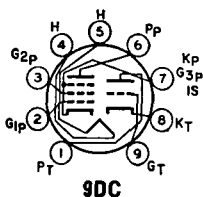
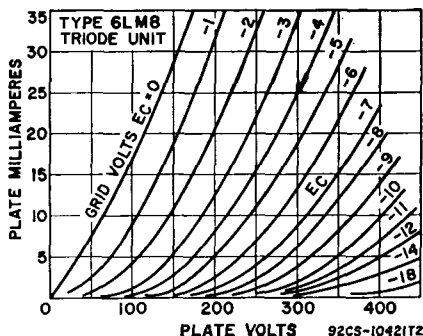
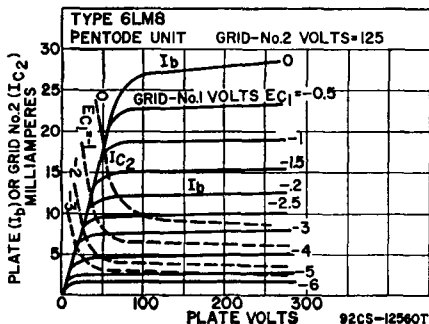

**6LN8/
LCF80**
**MEDIUM-MU TRIODE—
SHARP-CUTOFF PENTODE**

Miniature type used in frequency-changer service in television receivers. Outlines section, 6B; requires miniature 9-contact socket.

Heater Voltage (ac/dc)	6	volts
Heater Current	0.45	ampere
Peak Heater-Cathode Voltage	±100 max	volts

Class A₁ Amplifier

MAXIMUM RATINGS (Design-Maximum Values)	Triode Unit	Pentode Unit	
Plate Supply Voltage	550	550	volts
Plate Voltage	250	250	volts
Grid-No.2 (Screen-Grid) Supply Voltage	—	550	volts
Grid-No.2 Voltage:			
With cathode current of 14 mA	—	175	volts
With cathode current less than 10 mA	—	200	volts
Cathode Current	14	14	mA
Plate Dissipation	1.5	1.7	watts
Grid-No.2 Input:			
With plate dissipation greater than 1.2 watts	—	0.5	watt
With plate dissipation less than 1.2 watts	—	0.75	watt

CHARACTERISTICS

Plate Voltage	100	170	volts
Grid-No.2 Voltage	—	170	volts
Grid-No.1 Voltage	-2	-2	volts
Amplification Factor	20	—	
Mu-Factor, Grid No.2 to Grid No.1	—	47	
Plate Resistance (Approx.)	—	0.4	megohm
Transconductance	5000	6200	μmhos
Plate Current	14	10	mA
Grid-No.2 Current	—	2.8	mA
Input Resistance at frequency of 50 MHz	—	0.01	megohm
Equivalent Noise Resistance	—	1500	ohms

MAXIMUM CIRCUIT VALUES

Grid-No.1-Circuit Resistance:			
For fixed-bias operation	0.5	0.5	megohm
For cathode-bias operation	0.5	1	megohm

6LQ6

6LQ6/6JE6B
6LQ6/6JE6C

For replacement use type 6MJ6/6LQ6/6JE6C.

6LQ8

11LQ8

**MEDIUM-MU TRIODE—
SHARP-CUTOFF PENTODE**

Miniature type used in color and black-and-white television receiver applications. The pentode unit is used as a video output tube. The triode unit is used in sync separator and sound-if circuits. Outlines section, 6E; requires miniature 9-contact socket. Type 11LQ8 is identical with type 6LQ8 except for heater ratings.

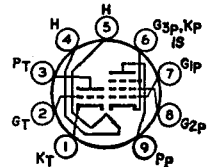

9DX

	6LQ8	11LQ8	
Heater Voltage (ac/dc)	6.3	10.9	volts
Heater Current	0.7	0.45	ampere
Heater Warm-up Time	—	11	seconds
Heater-Cathode Voltage:			
Peak value	±200 max	±200 max	volts
Average value	100 max	100 max	volts

Direct Interelectrode Capacitances:

Triode Unit:			
Grid to Plate		2.8	pF
Grid to Triode Cathode, Pentode Cathode, Heater, Pentode Grid No.3, and Internal Shield		4.2	pF
Plate to Triode Cathode, Pentode Cathode, Heater, Pentode Grid No.3, and Internal Shield		2.4	pF
Pentode Unit:			
Grid No.1 to Plate		0.12 max	pF
Grid No.1 to Cathode Heater, Grid No.2, Grid No.3, and Internal Shield		14	pF
Plate to Cathode, Heater, Grid No.2, Grid No.3, and Internal Shield		4.8	pF
Triode Grid to Pentode Plate		0.015 max	pF
Pentode Plate to Triode Plate		0.17 max	pF

Class A₁ Amplifier

MAXIMUM RATINGS (Design-Maximum Values)

	Triode Unit	Pentode Unit	
Plate Voltage	300	300	volts
Grid-No.2 (Screen-Grid) Supply Voltage	—	300	volts
Grid-No.2 Voltage	—	See curve page 300	
Grid-No.1 (Control-Grid) Voltage, Positive-bias value	0	0	volts
Plate Dissipation	2	5	watts
Grid-No.2 Input:			
For grid-No.2 voltages up to 150 volts	—	1	watts
For grid-No.2 voltages between 150 and 300 volts	—	See curve page 300	

CHARACTERISTICS

	Triode Unit	Pentode Unit		
Plate Supply Voltage	125	125	200	volts
Grid-No.2 Supply Voltage	—	125	125	volts
Cathode-Bias Resistor	68	82	68	ohms
Amplification Factor	46	—	—	
Plate Resistance (Approx.)	4400	55000	75000	ohms
Transconductance	10400	21000	23000	μmhos
Plate Current	15	16.5	20	mA
Grid-No.2 Current	—	3.1	3.5	mA
Grid-No.1 Voltage(Approx.) for plate current of 100 μA	-6	-4.2	-4.2	volts

MAXIMUM CIRCUIT VALUES

	Triode Unit	Pentode Unit	
Grid-No.1-Circuit Resistance:			
For fixed-bias operation	0.5	0.1	megohm
For cathode-bias operation	1	0.25	megohm

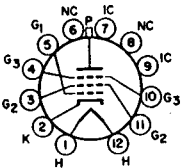
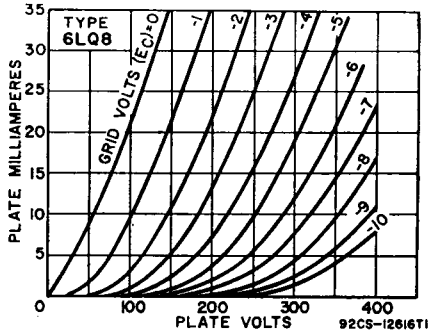
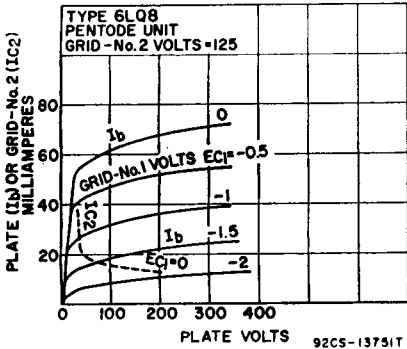

12FY

BEAM POWER TUBE

6LR6

35LR6

Duodeode type used as horizontal-deflection amplifier in color and black-and-white television receivers. An integral radiator-fin design dissipates heat uniformly. Outlines section, 16E; requires duodeode 12-contact socket. Type 35LR6 is identical with type 6LR6 except for heater ratings.

	6LR6 Parallel	35LR6 Series	
Heater Arrangement	Parallel	Series	
Heater Voltage (ac/dc)	6.3	35	volts
Heater Current	2.5	0.45±0.03	amperes
Heater Warm-up Time (Average)	—	11	seconds
Heater-Cathode Voltage:			
Peak value	±200 max	±200 max	volts
Average value	100 max	100 max	volts

Class A₁ Amplifier

CHARACTERISTICS

	Triode†† Connection	Pentode Connection			
Plate Voltage	125	60	175	60	volts
Grid-No.3 (Suppressor Grid) Voltage	—	—	Connected to cathode	at socket	
Grid-No.2 (Screen-Grid) Voltage	125	115	110	110	volts
Grid-No.1 (Control-Grid) Voltage	-20	0	-20	0	volts
Plate Resistance (Approx.)	—	—	5300	—	ohms

Transconductance (Grid No.1 to Plate)	—	—	16000	—	μmhos
Plate Current	—	740†	140	700	mA
Grid-No.2 Current	—	38†	2.4	35	mA
Grid-No.1 Voltage (Approx.) for plate current of 1 mA	—	—	—42	—	volts
Ratio (Plate Current/Grid No.2 Current)	—	19.5:1	—	20:1	—
Triode Amplification Factor	3.5	—	—	—	—

† This value can be measured by a method involving a recurrent waveform such that the maximum ratings of the tube will not be exceeded.

†† Grid No. 2 connected to plate.

Horizontal-Deflection Amplifier

For operation in a 525-line, 30-frame system

MAXIMUM RATINGS (Design-Maximum Values)

DC Plate Supply Voltage	990	volts
Peak Positive-Plate Pulse Voltage (Absolute Maximum)	7500	volts
Peak Negative-Pulse Plate Voltage	1100	volts
Positive Grid-No.3 Voltage	75	volts
DC Grid-No.2 Voltage	220	volts
Peak Negative-Pulse Grid-No.1 Voltage	330	volts
Average Cathode Current	375	mA
Peak Cathode Current	1300	mA
Plate Dissipation	30	watts
Grid-No.2 Input	5	watts
Bulb Temperature (At hottest point)	250	°C

MAXIMUM CIRCUIT VALUES

Grid-No.1-Circuit Resistance:		
Bias feedback high-voltage regulation	0.47	megohm
DC or pulse shunt high-voltage regulation	10	megohm

6LR8

21LR8, 31LR8

HIGH-MU TRIODE— BEAM POWER TUBE

Novar type used in combined vertical-deflection-oscillator and vertical-deflection-amplifier applications in color and black-and-white television receivers. Outlines section, 17E; requires novar 9-contact socket. Types 21LR8 and 31LR8 are identical with type 6LR8 except for heater ratings.

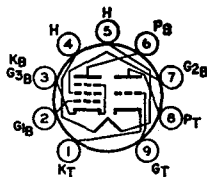

9QT

Heater Voltage	6LR8	21LR8	31LR8	volts
Heater Current	6.3	21	31.5	ampere
Heater Warm-up Time	1.5	0.45	0.3	seconds
Heater-Cathode Voltage:				
Peak value	±200 max	±200 max	±200 max	volts
Average value	100 max	100 max	100 max	volts

Class A₁ Amplifier

CHARACTERISTICS	Triode Unit		Beam Power Unit		
	Plate Voltage	250	45	135	
Grid-No.2 (Screen-Grid) Voltage	—	125	120	120*	volts
Grid-No.1 (Control-Grid) Voltage	-4	0	-10	-10	volts
Amplification Factor (Plate Resistance Approx.)	58	—	—	6.5	—
Transconductance	14000	—	14000	—	ohms
Plate Current	4100	—	9200	—	μmhos
Grid-No.2 Current	2.6	200*	51	—	mA
Grid-No.1 Voltage:		200*	3	—	mA
For plate current of 10 μA	-6.6	—	—	—	volts
For plate current of 100 μA	—	—	-28	—	volts
For plate current of 1 mA	—	—	-24	—	volts

* Triode connection, Grid No.2 connected to plate at socket.

* This value can be measured by a method involving a recurrent waveform such that the maximum ratings of the tube will not be exceeded.

Vertical-Deflection Oscillator and Amplifier

For operation in a 525-line, 30-frame system

MAXIMUM RATINGS (Design-Maximum Values)	Triode Unit Oscillator	Beam Power Unit Amplifier	
Plate Voltage	400	400	volts
Grid-No.2 Voltage	—	300	volts
Peak Positive-Pulse Plate Voltage#	—	2500	volts
Peak Negative-Pulse Grid-No.1 Voltage	400	250	volts
Peak Cathode Current	105	260	mA
Average Cathode Current	30	75	mA
Peak Power Output	2.5	—	watts
Plate Dissipation†	2.5	14	watts
Grid-No.2 Input‡	—	2.75	watts
Bulb Temperature	—	210	°C

MAXIMUM CIRCUIT VALUES

Grid-No.1-Circuit Resistance:			
For fixed-bias operation	—	1	megohm
For cathode-bias operation	2.2	2.2	megohms

Pulse duration must not exceed 15% of a horizontal scanning cycle (10 microseconds).

‡ A bias resistor or other means is required to protect the tube in absence of excitation.

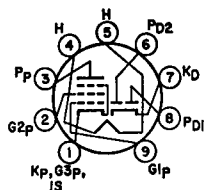

9RL

**TWIN DIODE—
SHARP-CUTOFF PENTODE**

6LT8

8LT8, 11LT8

Miniature type used in television receiver applications. The pentode unit is used in low-frequency horizontal-oscillator applications. The diode units are used in horizontal afc discriminator circuits. Outlines section, 6B; requires miniature 9-contact socket. Types 8LT8 and 11LT8 are identical with type 6LT8 except for heater ratings.

	6LT8	8LT8	11LT8	
Heater Voltage	6.3	8.1	11.4	volts
Heater Current	0.6	0.45	0.315	ampere
Heater Warm-up Time (Average)	11	11	11	seconds
Heater-Cathode Voltage:				
Peak value	±200 max	±200 max	±200 max	volts
Average value	100 max	100 max	100 max	volts

Pentode Unit as Class A₁ Amplifier

MAXIMUM RATINGS (Design-Maximum Values)

Plate Voltage	330	volts
Grid-No.2 (Screen-Grid) Supply Voltage	330	volts
Grid-No.2 Voltage	See curve page 300	
Grid-No.1 (Control-Grid) Voltage, Positive-bias value	0	volts
Plate Dissipation	3.1	watts
Grid-No.2 Input:		
For grid-No.2 voltages up to 165 volts	0.65	watt
For grid-No.2 voltages between 165 and 33 volts	See curve page 300	

CHARACTERISTICS

Plate Voltage	125	volts
Grid No.3 (Suppressor Grid)	Connected to ground	
Grid-No.2 Voltage	125	volts
Cathode-Bias Resistor	56	ohms
Plate Resistance (Approx.)	200000	ohms
Transconductance	13000	μmhos
Plate Current	10	mA
Grid-No.2 Current	3.4	mA
Grid-No.1 Voltage (Approx.) for plate current of 20 μA	—3.5	volts

MAXIMUM CIRCUIT VALUE

Grid-No.1-Circuit Resistance, for cathode-bias operation	1	megohm
----------------------------------------------------------	---	--------

Diode Unit (Each Unit)

MAXIMUM RATINGS (Design-Maximum Values)

Plate Current (Continuous Operation)	5	mA
--------------------------------------	---	----

CHARACTERISTICS, Instantaneous Value

Tube Voltage Drop for plate current of 20 mA	5	volts
----------------------------------------------	---	-------

6LU8

16LU8A, 21LU8

**HIGH-MU TRIODE—
BEAM POWER TUBE**

Duodecar type used as a combined vertical-deflection oscillator and vertical-deflection amplifier in color television receivers. Outlines section, 15D; requires duodecar 12-contact socket. Types 16LU8A and 21LU8 are identical with type 6LU8 except for heater ratings.

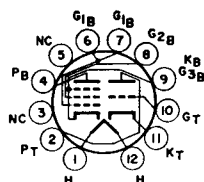
**12DZ**

	6LU8	16LU8A	21LU8	
Heater Voltage	6.3	16	21	volts
Heater Current	1.5	0.6	0.45	amperes
Heater Warm-up Time (Average)	—	11	11	seconds
Heater-Cathode Voltage:				
Peak value	±200 max	±200 max	±200 max	volts
Average value	100 max	100 max	100 max	volts

Class A₁ Amplifier

CHARACTERISTICS	Triode Unit		Beam Power Unit		
Plate Voltage	250	45	135	120	volts
Grid-No.2 (Screen-Grid) Voltage	—	125	120	120*	volts
Grid-No.1 (Control-Grid) Voltage	—4	0	—10	—10	volts
Amplification Factor	58	—	—	6.5	
Plate Resistance (Approx.)	16000	—	12900	—	ohms
Transconductance	3600	—	9300	—	μmhos
Plate Current	2.3	200**	56	—	mA
Grid-No.2 Current	—	20**	3	—	mA
Grid-No.1 Voltage (Approx.):					
For plate current of 10 μA	—6.6	—	—	—	volts
For plate current of 100 μA	—	—	—30	—	volts
For plate current of 1 mA	—	—	—26	—	volts

* Triode connection, Grid No.2 connected to plate at socket.

** This value can be measured by a method involving a recurrent waveform such that the maximum ratings of the tube will not be exceeded.

Vertical-Deflection Oscillator and Amplifier

For operation in a 525-line, 30-frame system

MAXIMUM RATINGS (Design-Maximum Values)	Triode Unit	Beam Power Unit	
	Oscillator	Amplifier	
Plate Voltage	400	400	volts
Grid-No.2 Voltage	—	300	volts
Peak Positive-Pulse Plate Voltage*	—	2500	volts
Peak Negative-Pulse Grid-No.1 Voltage	400	250	volts
Plate Dissipation*	2.5	14	watts
Peak Cathode Current	105	260	mA
Average Cathode Current	30	75	mA
Grid-No.2 Input	—	2.75	watts
Bulb Temperature (At hottest point)	—	210	°C
MAXIMUM CIRCUIT VALUES			
Grid-Circuit Resistance:			
For fixed-bias operation	—	1	megohm
For cathode-bias operation	2.2	2.2	megohms

Pulse duration must not exceed 15% of a horizontal scanning cycle (10 microseconds).

* A bias resistor or other means is required to protect the tube in absence of excitation.

6LX6

For replacement use type 6LF6/6LX6.

6LX8/LCF802

Refer to type 6JW8/ECF802.

6LY8

10LY8

**HIGH-MU TRIODE—
SHARP-CUTOFF PENTODE**

Miniature type used in color and black-and-white television receiver applications. The pentode unit is used as a video amplifier, and the triode unit for general-purpose use. Outlines section, 6E; requires 9-contact socket. Type 10LY8 is identical with type 6LY8 except for heater ratings.

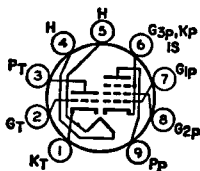
**9DX**

	6LY8	10LY8	
Heater Voltage	6.3	10.5	volts
Heater Current	0.75	0.45	ampere
Heater Warm-up Time (Average)	—	11	seconds
Heater-Cathode Voltage:			
Peak value	±200 max	±200 max	volts
Average value	100 max	100 max	volts

Class A₁ Amplifier

	Triode Unit	Pentode Unit	
MAXIMUM RATINGS (Design-Maximum Values)			
Plate Voltage	330	330	volts
Grid-No.2 (Screen-Grid) Supply Voltage	—	330	volts
Grid-No.2 Voltage	—	See curve page 300	
Grid-No.1 (Control-Grid) Voltage, Positive-bias value	0	0	volts
Plate Dissipation	1	5	watts
Grid-No.2 Input:			
For grid-No.2 voltages up to 165 volts	—	1.1	watts
For grid-No.2 voltages between 165 and 330 volts	—	See curve page 300	

CHARACTERISTICS

Plate Voltage	250	35	200	volts
Grid-No.2 Voltage	—	100	100	volts
Grid-No.1 Voltage	-2.0	0	—	volts
Cathode-Bias Resistor	—	—	82	ohms
Amplification Factor	100	—	—	
Plate Resistance (Approx.)	59000	—	60000	ohms
Transconductance	1700	—	20000	μmhos
Plate Current	1.0	54	19.5	mA
Grid-No.2 Current	—	13.5	3	mA
Grid Voltage (Approx.) for plate current of 10 μA	-5	—	—	volts
Grid-No.1 Voltage (Approx.) for plate current of 100 μA	—	—	-6.3	volts

MAXIMUM CIRCUIT VALUES

Grid-No.1-Circuit Resistance:			
For fixed-bias operation	0.5	0.5	megohm
For cathode-bias operation	1	1	megohm

Refer to chart at end of section.

6LZ6

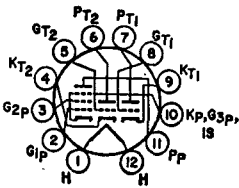

12CA

**HIGH-MU TWIN TRIODE—
SHARP-CUTOFF PENTODE**

6M11

Duodec type used in television receiver applications. The triode units are used in sync-separator and agc-amplifier circuits; the pentode unit is used in if-amplifier circuits. Outlines section, 8B; requires duodec 12-contact socket.

Heater Voltage (ac/dc)	6.3	volts
Heater Current	0.77	ampere
Heater-Cathode Voltage:		
Peak value	±200 max	volts
Average value	100 max	volts
Direct Interelectrode Capacitances: **		
Triode Units:		
Grid to Plate	1.8	pF
Grid to Triode Cathode, Pentode Cathode, Heater, Pentode Grid No.3, and Internal Shield	3.4	pF
Plate to Triode Cathode, Pentode Cathode, Heater, Pentode Grid No.3, and Internal Shield	0.8	pF
Pentode:		
Grid No.1 to Plate	0.03	pF
Grid No.1 to Cathode, Grid No.2, Grid No.3, and Internal Shield	12	pF
Plate to Cathode, Grid No.2, Grid No.3, and Internal Shield	2.8	pF

** With external shield connected to pentode cathode, grid No.3, and internal shield.

Class A₁ Amplifier

	Each		
	Triode Unit	Pentode Unit	
MAXIMUM RATINGS (Design-Maximum Values)			
Plate Voltage	330	330	volts
Grid-No.2 (Screen-Grid) Supply Voltage	—	330	volts
Grid-No.2 Voltage	—	See curve page 300	
Grid-No.1 (Control-Grid) Voltage, Positive-bias value	0	0	volts
Plate Dissipation	2.25	3.1	watts
Grid-No.2 Input:			
For voltages up to 165 volts	—	0.65	watt
For voltages between 165 and 330 volts	—	See curve page 300	

CHARACTERISTICS

Plate Supply Voltage	125	125	volts
Grid-No.2 Supply Voltage	—	125	volts
Cathode-Bias Resistor	125	56	ohms
Amplification Factor	58	—	
Plate Resistance (Approx.)	7250	200000	ohms
Transconductance	8000	13000	μ mhos
Plate Current	8	11	mA
Grid-No.2 Current	—	3.4	mA
Grid-No.1 Voltage (Approx.) for plate current of 20 μ A	—	—3.5	volts
Grid-No.1 Voltage (Approx.) for plate current of 50 μ A	—4.5	—	volts

MAXIMUM CIRCUIT VALUES

Grid-No.1-Circuit Resistance, for cathode-bias operation	0.68	1	megohm
----------------------------------------------------------------	------	---	--------

6MA6

Refer to chart at end of section.

6MB8

5MB8

HIGH-MU TRIODE SHARP-CUTOFF PENTODE

Miniature type with frame-grid pentode unit used in color television receivers. The triode unit is used in video-amplifier applications. The pentode unit is used in burst-amplifier service. Outlines section, 6B; requires miniature 9-contact socket. Type 5MB8 is identical with type 6MB8 except for heater ratings.

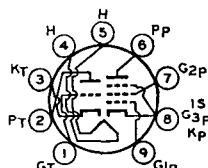

9FA

Heater Arrangement	5MB8 Series	6MB8 Parallel	
Heater Voltage (ac/dc)	5.6	6.3	volts
Heater Current	0.45	0.4	ampere
Heater Warm-up Time	11	—	seconds
Heater-Cathode Voltage:			
Peak value	± 200 max	± 200 max	volts
Average value	100 max	100 max	volts

Class A₁ Amplifier

MAXIMUM RATINGS (Design-Maximum Values)

	Triode Unit	Pentode Unit	
Plate Voltage	280	280	volts
Grid-No.2 (Screen-Grid) Supply Voltage	—	280	volts
Grid-No.2 Pulse Voltage	—	300	volts
Grid-No.2 Voltage	—	See curve page 300	
Grid-No.1 (Control-Grid) Voltage, Positive-bias value	0	0	volt
Plate Dissipation	2	2	watts
Cathode Current	20	20	mA
Grid-No.2 Input	—	0.5	watt

CHARACTERISTICS

Plate Voltage	125	125	volts
Grid-No.2 Voltage	—	125	volts
Grid-No.1 Voltage	0	0	volt
Cathode-Bias Resistor	68	33	ohm
Plate Current	13	10	mA
Grid-No.2 Current	—	2.8	mA
Transconductance	8000	12000	μ mhos
Amplification Factor	40	—	
Plate Resistance (Approx.)	5000	125000	ohms
Grid-No.1 Voltage for plate current of 100 μ A	—5	—	volts
Grid-No.1 Voltage for plate current of 50 μ A	—	—3	volts

MAXIMUM CIRCUIT VALUES

Grid-No.1-Circuit Resistance:			
For fixed-bias operation	Triode Unit 0.5	Pentode Unit 0.25	megohm
For cathode-bias operation	1	0.5	megohm

6MD8

12MD8

MEDIUM-MU TRIPLE TRIODE

Novar type used in matrixing circuits of color and black-and-white television receivers. Outlines section, 11E; requires novar 9-contact socket. Type 12MD8 is identical with type 6MD8 except for heater ratings.

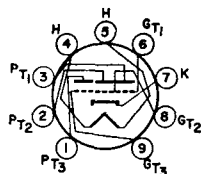

9RQ

	6MD8 Parallel	12MD8 Series	
Heater Arrangement			
Heater Voltage (ac/dc)	6.3	12.6	volts
Heater Current	0.9	0.45	ampere
Heater Warm-up Time (Average)	—	11	seconds
Heater-Cathode Voltage:			
Peak value	±200 max	±200 max	volts
Average value	100 max	100 max	volts
	Unit No.1	Unit No.2	Unit No.3
Direct Interelectrode Capacitances (Approx.):			
Grid to Plate	3	3	pF
Grid to Cathode and Heater	3.6	3.6	pF
Plate to Cathode and Heater	0.48	0.48	0.36

Class A₁ Amplifier (Each Unit)

MAXIMUM RATINGS (Design-Maximum Values)

Plate Voltage	330	volts
Grid Voltage, Positive-bias value	0	volts
Plate Dissipation	3	watts

CHARACTERISTICS

Plate Voltage	250	volts
Grid Voltage	-10.5	volts
Amplification Factor	17	
Plate Resistance (Approx.)	5500	ohms

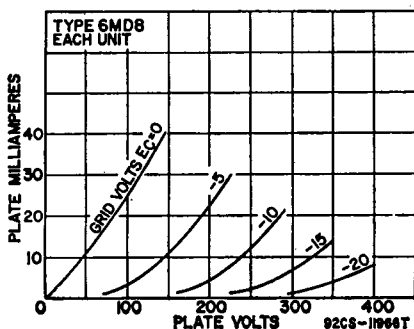

Transconductance	3100	μmhos
Plate Current	11.5	mA
Plate Current for grid voltage of -14 volts	4	mA
Grid Voltage (Approx.) for plate current of 50 μA	-23	volts

MAXIMUM CIRCUIT VALUE

Grid-Circuit Resistance, for fixed-bias operation	1	megohm
---------------------------------------------------	---	--------

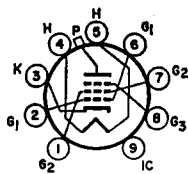

9QL

BEAM POWER TUBE

6ME6

Novar types used as horizontal-deflection amplifier in color and black-and-white television receivers. Outlines section, 32C; require novar 9-contact socket.

Heater Voltage (ac/dc)	6.3 ±0.6	volts
Heater Current	2.3	amperes
Heater-Cathode Voltage:		
Peak value	±200 max	volts
Average value	100 max	volts
Direct Interelectrode Capacitances:		
Grid No.1 to Plate	0.6	pF
Grid No.1 to Cathode, Heater, Grid No.2, and Grid No.3	22	pF
Plate to Cathode, Heater, Grid No.2, and Grid No.3	11	pF

Class A₁ Amplifier

CHARACTERISTICS	Triode* Connection		Pentode Connection		
Peak Positive-Pulse Plate Voltage#	—	5000	—	—	volts
Plate Voltage	125	—	55	175	volts
Grid-No.3 (Suppressor-Grid) Voltage	—	0	30	30	volts
Grid-No.2 (Screen-Grid) Voltage	125	125	125	125	volts
Grid-No.1 (Control-Grid) Voltage	-25	—	0	-25	volts
Plate Resistance (Approx.)	—	—	—	5800	ohms
Transconductance	—	—	—	9600	μmhos
Plate Current	—	—	580 $\frac{1}{2}$	130	mA
Grid-No.2 Current	—	—	40 $\frac{1}{2}$	2.8	mA
Grid-No.1 Voltage for plate current of 1 mA	—	-125	—	-44	volts
Amplification Factor	3.5	—	—	—	

* Grid No.3 and grid No.2 connected, respectively, to cathode and plate at socket.

† This value may be measured by a method involving a recurrent waveform such that the maximum ratings of the tube will not be exceeded.

Horizontal-Deflection Amplifier

For operation in a 525-line, 30-frame system

MAXIMUM RATINGS (Design-Maximum Values)

Plate Supply Voltage	990	volts
Peak Positive-Pulse Plate Voltage#	7500	volts
Peak Negative-Pulse Plate Voltage	1100	volts
Grid-No.3 Voltage*	75	volts
Grid-No.2 Voltage	220	volts
Peak Negative-Pulse Grid-No.1 Voltage	330	volts
Peak Cathode Current	1200	mA
Average Cathode Current	350	mA
Plate Dissipation*	30	watts
Plate Dissipation (Temporary overload)†	200	watts
Grid-No.2 Input	5	watts
Envelope Temperature (At hottest point)	250	°C

MAXIMUM CIRCUIT VALUES

Grid-No.1-Circuit Resistance for Cathode Bias (with min. R _k = 100Ω)	1.0	megohm
Grid-leak Bias (with signal peak clamped to zero bias)	10.0	megohms
Fixed Bias (where positive grid current is not drawn)	0.47	megohm

Pulse duration must not exceed 15% of a horizontal scanning cycle (10 microseconds).

* For horizontal-deflection service, a positive voltage may be applied to grid-No.3 to minimize "snivets" interference in both vhf and uhf television receivers. A typical value is 30 volts.

† A bias resistor or other means is required to protect the tube in absence of excitation.

‡ Total continuous or accumulated time not to exceed 40 seconds.

6ME8

TWO-PLATE
BEAM-DEFLECTION TUBE

Miniature type used for color-demodulator applications in color television receivers and a variety of other switching and gate applications. Outlines section, 6E; requires miniature 9-contact socket. Pin 5 should be connected directly to ground. The 6ME8 should be so located in the equipment that it is not subjected to stray magnetic fields.

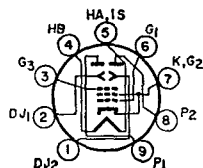

9RU

Heater Voltage (ac/dc)	6.3	volts
Heater Current	0.3	ampere
Direct Interelectrode Capacitances:		
Grid No.1 to All Other Electrodes Except Plates	7.5	pF
Either Plate to All Other Electrodes	6	pF
Either Deflecting Electrode to All Other Electrodes	6	pF
Plate No.1 to Plate No.2	0.4	pF
Deflecting Electrode No.1 to Deflecting Electrode No.2	0.4	pF
Grid No.1 to Deflecting Electrode No.1	0.07 max	pF
Grid No.1 to Deflecting Electrode No.2	0.1 max	pF

Color TV Demodulator

MAXIMUM RATINGS (Design-Maximum Values)

Plate Voltage (Each Plate)	400	volts
Peak Deflecting-Electrode Voltage (Each Electrode)	±200	volts
Deflecting-Electrode Voltage (Each Electrode)	100	volts
Grid-No.3 (Accelerating-Grid) Voltage	400	volts
Grid-No.1 (Control-Grid) Voltage, Positive-bias value	0	volts
Cathode Current	30	mA
Plate Dissipation (Each Plate)	2	watts
Grid-No.3 Input	2	watts

MAXIMUM CIRCUIT VALUES

Grid-No.1-Circuit Resistance:		
For fixed-bias operation	0.1	megohm
For cathode-bias operation	0.25	megohm

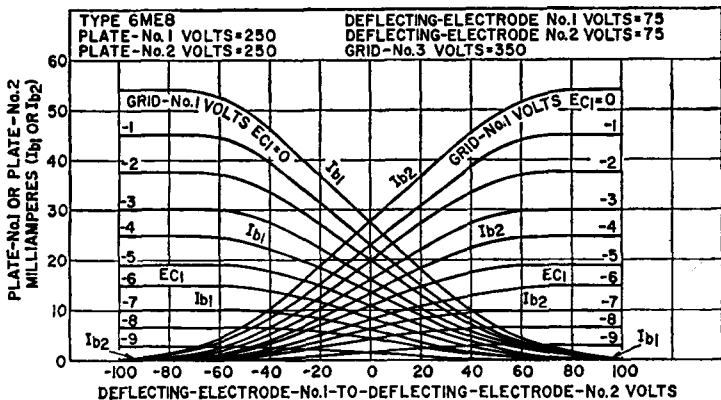

Class A₁ Amplifier

CHARACTERISTICS

Plate-No.2 Supply Voltage	250	volts
Plate-No.2	Connected to Plate No.1	
Plate-No.1 Supply Voltage	250	volts
Grid-No.3 Supply Voltage	350	volts
Grid-No.1 Supply Voltage	0	volts
Deflecting-Electrode-No.2 Supply Voltage	75	volts
Deflecting-Electrode-No.1 Supply Voltage	75	volts
Cathode-Bias Resistor	390	ohms
Transconductance, Grid No.1 to both plates	4400	μmhos
Total Plate Current	14.5	mA
Grid-No.3 Current	0.7	mA
Grid-No.1 Voltage for total plate current of 10 μA	-16	volts
Deflecting-Electrode Switching Voltage*	30 max	volts
Voltage Difference between Deflecting Electrodes for equal plate currents	0	volts
Plate-No.1 Current with Deflecting-Electrode-No.1 Voltage = 55V and Deflecting-Electrode-No.2 Voltage = 95V	1.3 max	mA
Plate-No.2 Current with Deflecting-Electrode-No.1 Voltage = 95V and Deflecting-Electrode-No.2 Voltage = 55V	1.3 max	mA
Deflecting-Electrode-No.1 Current with Deflecting-Electrode-No.1 Voltage = 125V and Deflecting-Electrode-No.2 Voltage = 25V	0.04 max	mA
Deflecting-Electrode-No.2 Current with Deflecting-Electrode-No.1 Voltage = 25V and Deflecting-Electrode-No.2 Voltage = 125V	0.04 max	mA

* Defined as the total voltage change from 75 volts on either deflecting electrode with an equal and opposite change on the other deflecting electrode required to switch the plate current from one plate to the other.

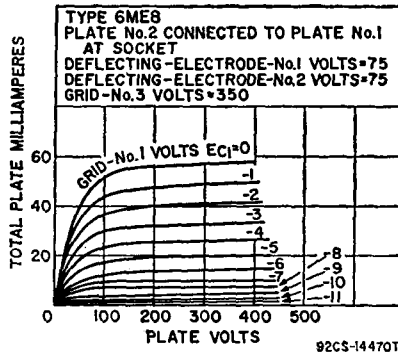

6MF8
15MF8

**HIGH-MU TRIODE—
BEAM POWER TUBE**

Duodecar type used in combined vertical-deflection-oscillator and vertical-deflection-amplifier applications in color television receivers. Outlines section, 15D; requires duodecar 12-contact socket. Type 15MF8 is identical with type 6MF8 except for heater ratings.

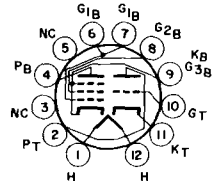

12DZ

	6MF8	15MF8	
Heater Voltage	6.3	14.7	volts
Heater Current	1.4	0.6	amperes
Heater-Cathode Voltage:			
Peak value	±200 max	±200 max	volts
Average value	100 max	100 max	volts

Class A₁ Amplifier

CHARACTERISTICS	Triode	Beam Power		
	Unit	Unit	Unit	
Plate Voltage	250	60	250	volts
Grid-No.2 (Screen-Grid) Voltage	—	250	250	volts
Grid-No.1 (Control-Grid) Voltage	—4	0	—20	volts
Plate Current	2.6	200	50	mA
Grid-No.2 Current	—	20	3.5	mA
Transconductance	4100	—	4100	μmhos
Amplification Factor	58	—	—	
Plate Resistance (Approx.)	14000	—	5000	ohms
Grid-No.1 Voltage for plate current of 10 μA	—6.6	—	—	volts
Grid-No.1 Voltage for plate current of 100 μA	—	—	—6.5	volts

Vertical-Deflection Oscillator and Amplifier

For operation in a 525-line, 30-frame system

	Triode Unit	Beam Power	
	Oscillator	Unit	
MAXIMUM RATINGS (Design-Maximum Values)		Amplifier	
Plate Voltage	400	400	volts
Peak Positive Pulse Plate Voltage#	—	2500	volts
Grid-No.2 Voltage	—	300	volts
Peak Negative Grid-No.1 Voltage	400	—	volts
Plate Dissipation*	2.5	12	watts
Grid-No.2 Dissipation*	—	2.75	watts
Average Cathode Current	30	75	mA
Peak Cathode Current	105	260	mA
Peak Power Output	2.5	—	watts
Bulb Temperature	—	200	°C

MAXIMUM CIRCUIT VALUES

Grid Circuit Resistance:			
For fixed-bias operation	—	1	megohm
For cathode-bias operation	2.2	2.2	megohms

Pulse duration must not exceed 15% of a vertical scanning cycle (2.5 milliseconds).
* A bias resistor or other means is required to protect the tube in absence of excitation.

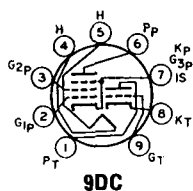

**MEDIUM-MU TRIODE—
SHARP-CUTOFF PENTODE**

6MG8

Miniature type used in horizontal-deflection circuits and for age-amplifier or sync-separator applications in television receivers. Outlines section, 6B; requires miniature 9-contact socket. Heater: volts, 6.3; ampere, 0.45; maximum heater-cathode volts, ± 200 peak, 100 average.

Class A₁ Amplifier

CHARACTERISTICS

	Triode Unit	Pentode Unit	
Plate Voltage	150	170	volts
Grid-No.2 (Screen-Grid) Voltage	—	170	volts
Grid-No.1 (Control-Grid) Voltage	—	—2	volts
Cathode-Bias Resistor	56	—	ohms
Plate Current	18	10	mA
Grid-No.2 Current	—	2.3	mA
Transconductance	8500	6200	μ mhos
Plate Resistance (Approx.)	5	400	kohms
Amplification Factor	40	47	
Grid-No.1 Voltage for plate current of 10 μ A	—12	—	volts

Horizontal-Deflection Amplifier

MAXIMUM RATINGS (Design-Maximum Values)

	Triode Unit	Pentode Unit	
Plate Voltage	330	330	volts
Grid-No.2 Supply Voltage	—	300	volts
Plate Dissipation	2.5	2	watts
Cathode Current	14	14	mA
Grid-No.2 Input:			
For plate dissipation more than 1.2 watts	—	0.5	watt
For plate dissipation less than 1.2 watts	—	0.75	watt

MAXIMUM CIRCUIT VALUES

Grid-No.1 Circuit Resistance:			
For fixed-bias operation	0.5	0.5	megohm
For cathode-bias operation	0.5	1	megohm

For replacement use type 6J6A.

6MHH3

6MJ6/

BEAM POWER TUBE

6LQ6/6JE6C

24LQ6/24JE6C, 31LQ6

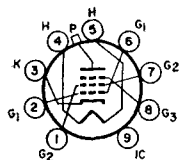

9QL

Novar types used as horizontal-deflection amplifier in color and black-and-white television receivers. Outlines section, 32C; requires novar 9-contact socket. Types 24LQ6/24JE6C, and 31LQ6 are identical with type 6MJ6/6LQ6/6JE6C except for heater ratings.

	6MJ6/ 6LQ6/6JE6C	24LQ6/24JE6C	31LQ6	
Heater Voltage (ac/dc)	6.3	24	31	volts
Heater Current	2.3	0.6	0.45	amperes
Heater Warm-up Time	—	11	11	seconds
Heater-Cathode Voltage:				
Peak value	± 200 max	± 200 max	± 200 max	volts
Average value	100 max	100 max	100 max	volts
Direct Interelectrode Capacitances:				
Grid No.1 to Plate	—	—	0.6	pF
Grid No.1 to Cathode, Heater, Grid No.2, and Grid No.3	—	—	22	pF
Plate to Cathode, Heater, Grid No.2, and Grid No.3	—	—	11	pF

Class A₁ Amplifier

CHARACTERISTICS

	Triode* Connection	5000	Pentode Connection	
Peak Positive-Pulse Plate Voltage#	—	—	—	volts
Plate Voltage	145	—	175	volts
Grid-No.3 (Suppressor-Grid) Voltage	—	30	—	volts
Grid-No.2 (Screen-Grid) Voltage	145	145	145	volts
Grid-No.1 (Control-Grid) Voltage	—35	—	—35	volts
Plate Resistance (Approx.)	—	—	7000	ohms
Transconductance	—	—	7500	μ mhos
Plate Current	—	—	95	mA

Grid-No.2 Current	—	—	55†	2.4	mA
Grid-No.1 Voltage for plate current of 1 mA	—	-125	—	-60	volts
Amplification Factor	2.8	—	—	—	—

* Grid No.3 and grid No.2 connected, respectively, to cathode and plate at socket.

† This value may be measured by a method involving a recurrent waveform such that the maximum ratings of the tube will not be exceeded.

Horizontal-Deflection Amplifier

For operation in a 525-line, 30-frame system

MAXIMUM RATINGS (Design-Maximum Values)

Plate Supply Voltage	990	volts
Peak Positive-Pulse Plate Voltage#	7500	volts
Peak Negative-Pulse Plate Voltage	1100	volts
Grid-No.3 Voltage [■]	75	volts
Grid-No.2 Voltage	220	volts
Peak Negative-Pulse Grid-No.1 Voltage	330	volts
Peak Cathode Current	1200	mA
Average Cathode Current	350	mA
Plate Dissipation [○]	30	watts
Plate Dissipation (Temporary overload) [▲]	200	watts
Grid-No.2 Input	5	watts
Envelope Temperature (At hottest point)	250	°C

MAXIMUM CIRCUIT VALUES

Grid-No.1-Circuit Resistance:

For grid-No.1-resistor-bias operation	0.47	megohm
For plate-pulsed operation (horizontal-deflection circuits only)	10	megohms

Pulse duration must not exceed 15% of a horizontal scanning cycle (10 microseconds).

■ For horizontal-deflection service, a positive voltage may be applied to grid-No.3 to minimize "snivets" interference in both vhf and uhf television receivers. A typical value is 30 volts.

○ A bias resistor or other means is required to protect the tube in absence of excitation.

▲ Total continuous or accumulated time not to exceed 40 seconds.

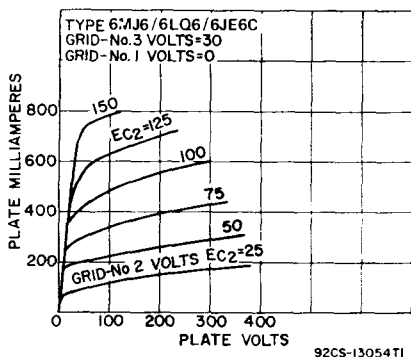
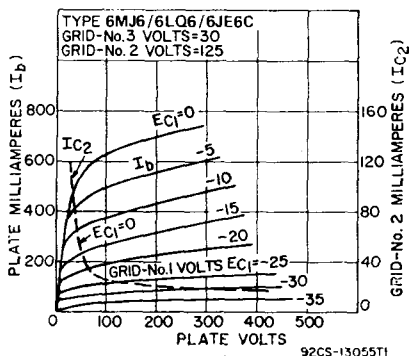

6MJ8

MEDIUM-MU TRIPLE TRIODE

Duodecar type used in matrixing-amplifier circuits of color and black-and-white television receivers. Outlines section, 8D; requires duodecar 12-contact socket.

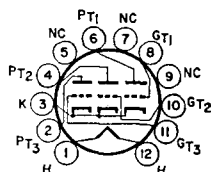

12HG

Heater Voltage	6.3	volts		
Heater Current	0.9	ampere		
Heater-Cathode Voltage:				
Peak value	±200 max	volts		
Average value	100 max	volts		
Direct Interelectrode Capacitances:	Unit	Unit	Unit	
Grid to Plate	No.1	No.2	No.3	pF
Grid to Cathode and Heater	2.8	2.8	2.8	pF
Plate to Cathode and Heater	2.9	2.9	3	pF
	0.36	0.6	0.7	pF

Class A₁ Amplifier (Each Unit)

MAXIMUM RATINGS (Design-Maximum Values)

Plate Voltage	330	volts
Grid Voltage, Positive-bias value	0	volts
Plate Dissipation	3	watts

CHARACTERISTICS

Plate Voltage	250	volts
Grid Voltage	-10.5	volts
Plate Current	10	mA
Amplification Factor	17	
Plate Resistance (Approx.)	5600	ohms
Transconductance	3000	μmhos
Plate Current for grid voltage of -14 volts	4	mA
Grid Voltage for plate current of 50 μA	-23	volts

MAXIMUM CIRCUIT VALUE

Grid-Circuit Resistance, for fixed-bias operation	1	megohm
---------------------------------------------------------	---	--------

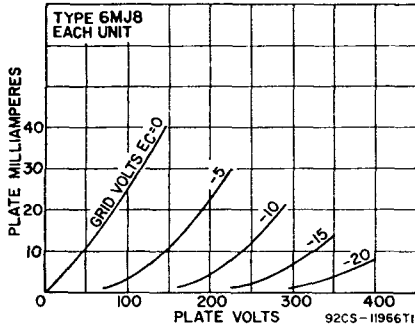

Refer to chart at end of section.
For replacement use type 6MK8A.

6MK8

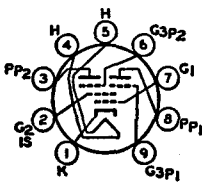

9FG

**SHARP-CUTOFF
TWIN PENTODE**

Miniature type used in sync-separator, clipper, agc, and low-level color-demodulator circuits in television receivers. Outlines section, 6E; requires miniature 9-contact socket.

6MK8A

4MK8

Heater Voltage	6.3	volts
Heater Current	0.3	ampere
Heater-Cathode Voltage:		
Peak value	±200 max	volts
Average value	100 max	volts
Direct Interelectrode Capacitances:		
Grid No.3 to Plate (Each Section)	2	pF
Grid No.1 to All Electrodes	6	pF
Grid No.3 (Each Section) to All Electrodes	3.6	pF
Plate (Each Section) to All Electrodes	3	pF
Grid No.3 (Section 1) to Grid No.3 (Section 2)	0.015 max	pF

Class A₁ Amplifier

MAXIMUM RATINGS (Design-Maximum Values)

Plate Voltage (Each Unit)	300	volts
Grid-No.3 (Suppressor-Grid) Voltage (Each Unit)		
Peak positive value	50	volts
DC negative value	50	volts
DC positive value	3	volts

Grid-No.2 (Screen-Grid) Voltage	150	volts
Grid-No.1 (Control-Grid) Voltage, Negative-bias value	50	volts
Cathode Current	12	mA
Plate Dissipation (Each Section)	1.1	watts
Grid-No.2 Input	0.75	watt

MAXIMUM PLATE CURRENT RATIO (Balance): 6MK8A — 1.2 to 1; 4MK8 — 1.3 to 1

Plate Voltage	100	volts
Grid-No.2 Voltage	67.5	volts
Grid-No.1 Voltage	67.5	volts
Grid-No.3 Voltage	0	volts
Grid-No.1 Resistance	0.68	megohm

CHARACTERISTICS

With One Unit Operating*

Plate Voltage	100	100	volts
Grid-No.3 Voltage	0	0	volts
Grid-No.2 Voltage	67.5	67.5	volts
Grid-No.1 Voltage	0	*	volts
Transconductance, Grid No.3 to Plate	—	450	μ mhos
Transconductance, Grid No.1 to Plate	1100	—	μ mhos
Plate Current	—	2	mA
Grid-No.3 Voltage (Approx.) for plate current of 100 μ A	—	-3.5	volts
Grid-No.1 Voltage (Approx.) for plate current of 100 μ A	—	-2.3	volts

With Both Units Operating

Plate Voltage (Each Unit)	100	100	volts
Grid-No.3 Voltage (Each Unit)	-10	0	volts
Grid-No.2 Voltage	67.5	67.5	volts
Grid-No.1 Voltage	*	*	volts
Plate Current (Each Section)	—	2	mA
Cathode Current	7.1	8.5	mA
Grid-No.2 Current	7	4.4	mA

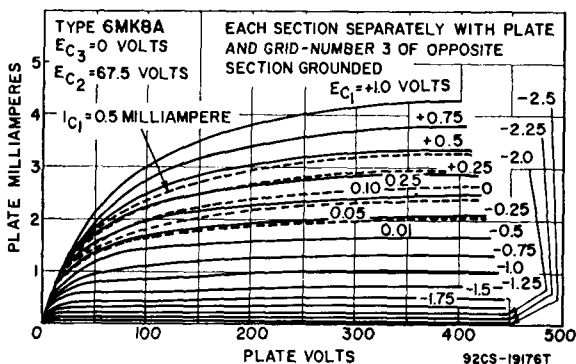
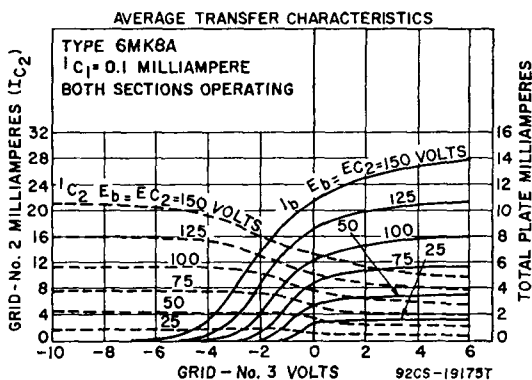

MAXIMUM CIRCUIT VALUES

Grid-No.3-Circuit Resistance (Each Unit)	0.5	megohm
Grid-No.1-Circuit Resistance	0.5	megohm

• With plate and grid No.3 of other unit grounded. * Grid current adjusted for 100 μ A dc.

Refer to chart at end of section.

6ML8

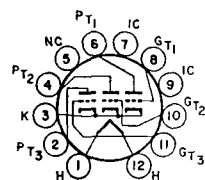

12HU

**HIGH-MU
TRIPLE TRIODE**

6MN8

9MN8

Duodecar type used for matrix-amplifier applications in color television receivers. **Outlines** section, 8D; requires duodecar 12-contact socket. Type 9MN8 is identical with type 6MN8 except for heater ratings.

Heater Voltage	6MN8	9MN8	
Heater Current	6.3	9.5	volts
	0.9	0.6	ampere
	—	11	seconds
Heater-Cathode Voltage:			
Peak value	± 200 max	± 200 max	volts
Average value	± 100 max	± 100 max	volts
Direct Interelectrode Capacitances:			
	Unit No.1	Unit No.2	Unit No.3
Grid to Plate	2.6	2.6	2.6
Grid to Cathode and Heater	4.6	4.6	4.6
Plate to Cathode and Heater	0.33	0.57	0.65
			pF
			pF
			pF

Class A₁ Amplifier (Each Unit)

MAXIMUM RATINGS (Design-Maximum Values)

Plate Voltage	330	volts
Grid Voltage, Positive-bias value	0	volt
Plate Dissipation	3	watts

CHARACTERISTICS

Plate Voltage	125	200	volts
Grid Voltage	—1	—4	volts
Amplification Factor	47	40	
Plate Resistance (Approx.)	6250	10000	ohms
Transconductance	7500	4000	μ mhos
Plate Current	11	4.8	mA
Grid Voltage (Approx.) for plate current of 50 μ A	—5	—11	volts

MAXIMUM CIRCUIT VALUE

Grid-Circuit Resistance, for fixed-bias operation	1	megohm
---------------------------------------------------------	---	--------

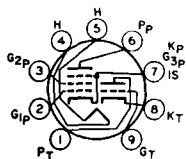

9AE

**MEDIUM-MU TRIODE—
SHARP-CUTOFF PENTODE**

6MQ8

5MQ8

Miniature type used in color and black-and-white television receiver applications. The pentode unit is used in band-pass-amplifier applications. The triode unit is used in video-amplifier, sync-separator, color-killer-control, matrix-amplifier, and blanker applications. **Outlines** section, 6B; requires miniature 9-contact socket. Type 5MQ8 is identical with type 6MQ8 except for heater ratings.

Heater Voltage (ac/dc)	5MQ8	6MQ8	
Heater Current	5.6	6.3	volts
Heater Warm-up Time	0.6	0.535	ampere
Heater Cathode Voltage:			seconds
Peak value	± 200 max	± 200 max	volts
Average value	100 max	100 max	volts
Direct Interelectrode Capacitances:			
Triode Unit:			
Grid to Plate		1.7	pF
Grid to Triode Cathode, Pentode Cathode, Heater, Pentode Grid No.3, and Internal Shield		3	pF

Plate to Triode Cathode, Pentode Cathode, Heater, Pentode Grid No.3, and Internal Shield	1.4	pF
Pentode Unit: Grid No.1 to Plate	0.045	pF
Grid No.1 to Cathode, Heater, Grid No.2, Grid No.3, and Internal Shield	7.5	pF
Plate to Cathode, Heater, Grid No.2, Grid No.3, and Internal Shield	2.2	pF

Class A₁ Amplifier

MAXIMUM RATINGS

	Triode Unit	Pentode Unit	
DC Plate Voltage	330	330	volts
DC Grid-No.2 (Screen-Grid) Supply Voltage	—	330	volts
DC Grid-No.2 Voltage	—	See curve page 300	
DC Grid-No.1 (Control-Grid) Voltage, Positive-bias value	0	0	volt
Plate Dissipation	2.7	2.5	watts
Grid-No.2 Input: For grid-No.2 voltages up to 165 volts	—	0.55	watt
For grid-No.2 voltages between 165 and 330 volts	—	See curve page 300	
Interelectrode Leakage	109	100	megohms

CHARACTERISTICS

	Triode Unit	Pentode Unit	
DC Plate Voltage	150	125	volts
DC Grid-No.2 Voltage	—	125	volts
Cathode Resistance	56	62	ohms
Amplification Factor	40	—	
Plate Resistance (Approx.)	5	150	kohms
Transconductance	8500	10000	μmhos
DC Plate Current	18	12	mA
DC Grid-No.2 Current	—	4.5	mA
Grid-No.1 Voltage for plate current of 100 μA	—12	—7	volts

MAXIMUM CIRCUIT VALUES

Grid-No.1-Circuit Resistance: For fixed-bias operation	0.5	0.25	megohms
For cathode-bias operation	0.5	0.5	megohms

6MU8

**MEDIUM-MU TRIODE—
SEMIREMOTE-CUTOFF
PENTODE**

Miniature type used in color and black-and-white television receiver applications. The pentode unit is used in burst-amplifier circuits, and the triode unit as a general amplifier tube. Outlines section, 6E; requires miniature 9-contact socket.

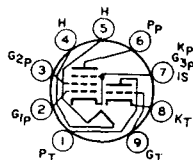

9AE

Heater Voltage	6.3	volts
Heater Current	0.6	ampere
Heater Warm-up Time	11	seconds
Heater-Cathode Voltage: Peak value	±200 max	volts
Average value	100 max	volts

Direct Interelectrode Capacitances:

	With Shield	Without Shield	
Triode Unit:			
Grid to Plate	2.2	2.2	pF
Grid to Cathode, Heater, Pentode Cathode, Pentode Grid No.3, and Internal Shield	3.2	3	pF
Plate to Cathode, Heater, Pentode Cathode, Pentode Grid No.3, and Internal Shield	3.4	2.2	pF
Pentode Unit:			
Grid No.1 to Plate	0.05	0.05	pF
Grid No.1 to Cathode, Heater, Grid No.2, Grid No.3, and Internal Shield	9	9	pF
Plate to Cathode, Heater, Grid No.2, Grid No.3, and Internal Shield	4.4	3.6	pF
Heater to Triode Cathode	4.8	4.4	pF
Heater to Pentode Cathode	7.5	5.5	pF
Pentode Grid No.1 to Triode Plate	0.2	0.17	pF
Pentode Plate to Triode Plate	0.008	0.09	pF

Class A₁ Amplifier

MAXIMUM RATINGS (Design-Maximum Values)

	Triode Unit	Pentode Unit	
Plate Voltage	330	330	volts
Grid-No.2 (Screen-Grid) Supply Voltage	—	330	volts
Grid-No.2 Voltage	—	See curve page 300	
Grid-No.1 (Control-Grid) Voltage, Positive-bias value	0	0	volts
Grid-No.2 Input	2.5	3.75	watts
Plate Dissipation	—	1.1	watts

CHARACTERISTICS

	Triode Unit	Pentode Unit	
Plate Voltage	125	150	volts
Grid-No.2 Voltage	—	150	volts
Grid-No.1 Voltage	—1	—	volts
Cathode Bias Resistor	—	150	ohms
Plate Current	11.5	19	mA
Grid-No.2 Current	—	4.2	mA
Transconductance	6000	9000	μmhos
Amplification Factor	35	—	
Plate Resistance (Approx.)	5800	165000	ohms
Grid-No.1 Voltage (Approx.) for plate current of 10 μA	—5.8	—	volts
Grid-No.1 Voltage (Approx.) for plate current of 20 μA	—	—9.5	volts

MAXIMUM CIRCUIT VALUES

Grid-No.1-Circuit Resistance:			
For fixed-bias operation	0.5	0.25	megohms
For cathode-bias operation	1	1	megohms

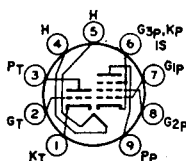

9DX

**HIGH-MU TRIODE—
SHARP-CUTOFF PENTODE**

6MV8

Miniature type used for general-purpose applications. The pentode unit is used as an if-amplifier, and the triode unit as a sync-separator or voltage amplifier. Outlines section, 6B; requires miniature 9-contact socket. **Heater:** volts, 6.3; ampere, 0.6; maximum heater-cathode volts, ±200 peak, 100 average.

Class A₁ Amplifier

MAXIMUM RATINGS (Design-Maximum Values)

	Triode Unit	Pentode Unit	
Plate Voltage	330	330	volts
Grid-No. 2 (Screen-Grid) Supply Voltage	—	330	volts
Grid-No. 2 Voltage	—	See curve page 300	
Grid-No. 1 (Control-Grid) Voltage, Positive bias value	0	0	volts
Plate Dissipation	1	2.5	watts
Grid-No. 2 Input	—	0.55	watts

CHARACTERISTICS

	Triode Unit	Pentode Unit	
Plate Voltage	250	125	volts
Grid-No. 2 Voltage	—	125	volts
Grid-No. 1 Voltage	—2	—1	volts
Plate Current	2.5	13	mA
Grid-No. 2 Current	—	4	mA
Transconductance	4000	9000	μmhos
Amplification Factor	100	—	
Plate Resistance (Approx.)	25000	150000	ohms
Grid-No. 1 Voltage (Approx.) for plate current of 20 μA	—4.5	—6	volts

MAXIMUM CIRCUIT VALUES

Grid-No. 1-Circuit Resistance:			
For fixed-bias operation	0.5	0.25	megohms
For cathode-bias operation	1	1	megohms

Refer to chart at end of section.

6N6G

6N7
6N7GT
6P5GT
6P7G
6Q7
6Q7G
6Q7GT

Refer to chart at end of section.

Refer to chart at end of section.

Refer to chart at end of section.

Refer to chart at end of section.

6Q11

Refer to chart at end of section.
For replacement use type 6K11/6Q11.

6R7
6R7G
6R7GT

Refer to chart at end of section.

6RHH2

For replacement use type 6BC8/6BZ8.

6RHH8

For replacement use type 6KN8/6RHH8.

6RK19

For replacement use type 6BR3/6RK19.

6RP22

Refer to chart at end of section.

6S4

Refer to chart at end of section.

6S4A

MEDIUM-MU TRIODE

Miniature type used as vertical-deflection amplifier in color and black-and-white television receivers. **Outlines** section, 6E; requires miniature 9-contact socket.

Heater Voltage (ac/dc)	6.3	volts
Heater Current	0.6	ampere
Heater Warm-up Time (Average)	11	seconds
Heater-Cathode Voltage:		
Peak value	±200 max	volts
Average value	100 max	volts
Direct Interelectrode Capacitances (Approx.):		
Grid to Plate	2.4	pF
Grid to Cathode and Heater	4.2	pF
Plate to Cathode and Heater	0.6	pF

Class A₁ Amplifier

CHARACTERISTICS

Plate Voltage	250	volts
Grid Voltage	-8	volts
Amplification Factor	16.5	
Plate Resistance (Approx.)	3700	ohms
Transconductance	4500	μmhos
Plate Current	24	mA
Plate Current for grid voltage of -15 volts	4	mA
Grid Voltage (Approx.) for plate current of 50 μA	-22	volts

Vertical-Deflection Amplifier

For operation in a 525-line, 30-frame system

MAXIMUM RATINGS (Design-Maximum Values)

DC Plate Voltage	550	volts
Peak Positive-Pulse Plate Voltage#	2200	volts
Peak Negative-Pulse Grid Voltage	250	volts
Peak Cathode Current	105	mA
Average Cathode Current	30	mA
Plate Dissipation	8.5	watts

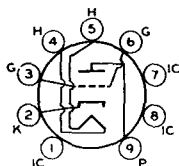

9AC

MAXIMUM CIRCUIT VALUE

Grid-Circuit Resistance, for cathode-bias operation 2.2 megohms
 # Pulse duration must not exceed 15% of a vertical scanning cycle (2.5 milliseconds).

- Refer to chart at end of section. **6S7**
6S7G
- Refer to chart at end of section. **6S8GT**
- Refer to chart at end of section. **6SA7**
6SA7GT
- Refer to chart at end of section. **6SB7Y**
- Refer to chart at end of section. **6SC7**
- Refer to chart at end of section. **6SF5**
6SF5GT
- Refer to chart at end of section. **6SF7**
- Refer to chart at end of section. **6SG7**
- Refer to chart at end of section. **6SH7**
- Refer to chart at end of section. **6SJ7**
6SJ7GT
- Refer to chart at end of section. **6SK7**
6SK7GT

6SL7GT
12SL7GT

HIGH-MU TWIN TRIODE

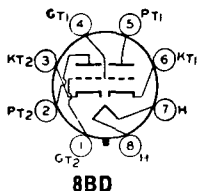

Glass octal type used as phase inverter in radio equipment. Each unit may also be used in resistance-coupled amplifier circuits. **Outlines section, 13D;** requires octal socket. Except for the common heater, each triode unit is independent of the other. For typical operation as

phase inverter or resistance-coupled amplifier, refer to **Resistance-Coupled Amplifier** section. Type 12SL7GT is identical with type 6SL7GT except for heater ratings.

	6SL7GT	12SL7GT	
Heater Voltage (ac/dc)	6.3	12.6	volts
Heater Current	0.3	0.15	ampere
Peak Heater-Cathode Voltage	±90 max	±90 max	volts
Direct Interelectrode Capacitances (Approx.):°	Unit No.1	Unit No.2	
Grid to Plate	2.8	2.8	pF
Grid to Cathode and Heater	3	3.4	pF
Plate to Cathode and Heater	3.8	3.2	pF

With external shield connected to cathode.

Class A₁ Amplifier

MAXIMUM RATINGS (Design-Center Values)

Plate Voltage	300	volts
Grid Voltage, Positive-bias value	0	volts
Plate Dissipation	1	watt

CHARACTERISTICS

Plate Voltage	250	volts
Grid Voltage	-2	volts
Amplification Factor	70	
Plate Resistance (Approx.)	44000	ohms
Transconductance	1600	μmhos
Plate Current	2.3	mA

6SN7GT
6SN7GTA

Refer to chart at end of section.

6SN7GTB MEDIUM-MU TWIN TRIODE

12SN7GTA

Glass octal type used as combined vertical oscillator and vertical-deflection amplifier, and as horizontal-deflection oscillator, in color and black-and-white television receivers. Each unit may also be used in multi-vibrator or resistance-coupled amplifier circuits in radio equipment. Outlines section, 13D; requires octal socket. Except for the common heater, each triode unit is independent of the other. For typical operation as resistance-coupled amplifier, refer to **Resistance-Coupled Amplifier** section. Type 12SN7GTA is identical with type 6SN7GTB except for heater ratings.

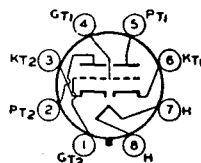

8BD

	6SN7GTB	12SN7GTA	
Heater Voltage (ac/dc)	6.3	12.6	volts
Heater Current	0.6	0.3	ampere
Heater Warm-up Time (Average)	11	—	seconds
Heater-Cathode Voltage:			
Peak value	±200 max	±200 max	volts
Average value	100 max	100 max	volts
Direct Interelectrode Capacitances (Approx.):	Unit No.1	Unit No.2	
Grid to Plate	4.0	3.8	pF
Grid to Cathode and Heater	2.2	2.6	pF
Plate to Cathode and Heater	0.7	0.7	pF

Class A₁ Amplifier (Each Unit)

MAXIMUM RATINGS (Design-Center Values)

Plate Voltage	450	volts
Cathode Current	20	mA
Plate Dissipation:		
For either plate	5	watts
For both plates with both units operating	7.5	watts

CHARACTERISTICS

Plate Voltage	90	250	volts
Grid Voltage	0	-8	volts
Amplification Factor	20	20	
Plate Resistance (Approx.)	6700	7700	ohms
Transconductance	3000	2600	μmhos
Plate Current	10	9	mA
Plate Current for grid voltage of -12.5 volts	—	1.3	mA
Grid Voltage (Approx.) for plate current of 10 μA	-7	-18	volts

MAXIMUM CIRCUIT VALUE

Grid-Circuit Resistance, for fixed-bias operation	1	megohm
---------------------------------------------------	---	--------

Oscillator (Each Unit)

For operation in a 525-line, 30-frame system

	Vertical-Deflection Oscillator	Horizontal-Deflection Oscillator	
MAXIMUM RATINGS (Design-Center Values)			
DC Plate Voltage	450	450	volts
Peak Negative-Pulse Grid Voltage	400	600	volts
Peak Cathode Current	70	300	mA
Average Cathode Current	20	20	mA
Plate Dissipation:			
For either plate	5	5	watts
For both plates with both units operating	7.5	7.5	watts
MAXIMUM CIRCUIT VALUES			
Grid-Circuit Resistance	2.2	2.2	megohms

Vertical-Deflection Amplifier (Each Unit)

For operation in a 525-line, 30-frame system

MAXIMUM RATINGS (Design-Center Values)

DC Plate Voltage	450	volts
Peak Positive-Pulse Plate Voltage# (Absolute maximum)	1500*	volts
Peak Negative-Pulse Grid Voltage	250	volts
Peak Cathode Current	70	mA

Average Cathode Current	20	mA
Plate Dissipation:		
For either plate	5	watts
For both plates with both units operating	7.5	watts

MAXIMUM CIRCUIT VALUE

Grid-Circuit Resistance, for cathode-bias operation	2.2	megohms
# Pulse duration must not exceed 15% of a vertical cycle (2.5 milliseconds).		
■ Under no circumstances should this absolute value be exceeded.		

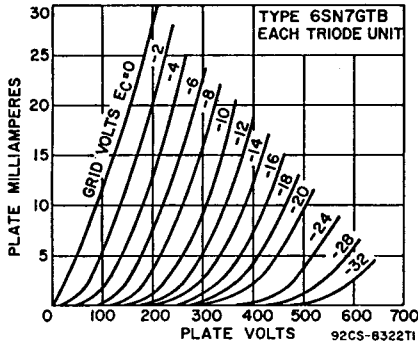

Refer to chart at end of section.

6SQ7
6SQ7GT

Refer to chart at end of section.

6SR7

Refer to chart at end of section.

6SS7

Refer to chart at end of section.

6ST7

Refer to chart at end of section.

6SZ7

Refer to chart at end of section.
For replacement use type 6AF4A.

6T4

Refer to chart at end of section.

6T7G

Refer to chart at end of section.

6T8

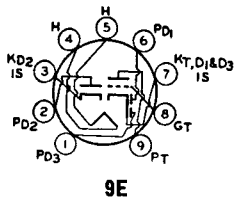

**TRIPLE DIODE—
HIGH-MU TRIODE**

6T8A

5T8, 19T8

Miniature type used as combined audio amplifier, AM detector, and FM detector in AM/FM radio receivers. Diode unit No.1 is used for AM detection, and diode units No.2 and No.3 are used for FM detection. **Outlines section, 6B;** requires miniature 9-contact socket. For typical operation as resistance-coupled amplifier, refer to **Resistance-Coupled Amplifier section.** Types 5T8 and 19T8 are identical with type 6T8A except for heater ratings.

	5T8	6T8A	19T8	
Heater Voltage (ac/dc)	4.7	6.3	18.9	volts
Heater Current	0.6	0.45	0.15	ampere
Heater Warm-up Time (Average)	11	11	11	seconds
Heater-Cathode Voltage:				
Peak value	±200 max	±100 max	±90 max	volts
Average value	100 max	--	--	volts

Direct Interelectrode Capacitances:

	Unshielded	Shielded	
Triode Unit:			
Grid to Plate	1.7	1.7	pF
Grid to Cathode, Internal Shield (pin 7), and Heater	1.6	1.7	pF
Plate to Cathode, Internal Shield (pin 7), and Heater	1.2	2.4	pF
Diode Units:			
Diode-No.1 Plate to Cathode, Internal Shield (pin 7), and Heater	3.8	3.8	pF
Diode-No.2 Plate to Cathode, Internal Shield (pin 3), and Heater	3.8	3.8*	pF
Diode-No.3 Plate to Cathode, Internal Shield (pin 7), and Heater	3.4	3.6	pF
Diode-No.2 Cathode, Internal Shield (pin 3) to All Other Electrodes, and Heater	7.5	8.5*	pF
Triode Grid to any Diode Plate	0.034 max	0.034 max	pF

* With external shield connected to pin 7 except as noted.
 * With external shield connected to pin 3.
 * With external shield connected to pins 4 and 5.

Triode Unit as Class A₁ Amplifier

MAXIMUM RATINGS (Design-Maximum Values)

Plate Voltage	330	volts
Grid Voltage, Positive-bias value	0	volts
Plate Dissipation	1.1	watts

CHARACTERISTICS

Plate Voltage	100	250	volts
Grid Voltage	-1	-3	volts
Amplification Factor	70	70	
Plate Resistance (Approx.)	54000	58000	ohms
Transconductance	1300	1200	μmhos
Plate Current	0.8	1	mA

Diode Units

MAXIMUM RATING (Design-Maximum Values)

Plate Current (Each Unit)	5.5	mA
---------------------------------	-----	----

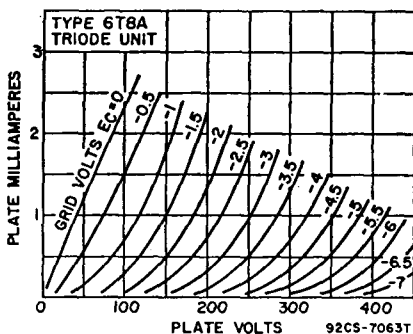

6T9

Refer to chart at end of section.

6T10

10T10, 12T10

BEAM POWER TUBE—
SHARP-CUTOFF PENTODE

Duodecar type used as combined FM detector and audio-frequency output amplifier in color and black-and-white television receivers. The beam power unit is used in af output stages, and the sharp-cutoff, dual-control pentode unit is used as an FM detector. Outlines section, 8C; requires duodecar 12-contact socket. For maximum ratings and characteristics, refer to type 6AL11. Types 10T10 and 12T10 are identical with type 6T10 except for heater ratings.

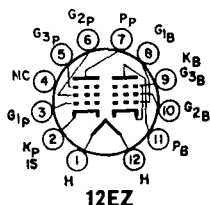

	6T10	10T10	12T10	
Heater Voltage (ac/dc)	6.3	9.8	12.6	volts
Heater Current	0.95	0.6	0.45	amperes
Heater Warm-up Time (Average)	—	11	11	seconds
Heater-Cathode Voltage:				
Peak value	±200 max	±200 max	±200 max	volts
Average value	100 max	100 max	100 max	volts
Direct Interelectrode Capacitances:				
Unit No.1:				
Grid No.1 to Plate			0.22	pF
Grid No.1 to Cathode, Heater, Grid No.2, Grid No.3, and Internal Shield			11	pF
Plate to Cathode, Heater, Grid No.2, Grid No.3, and Internal Shield			10	pF
Unit No.2:				
Grid No.1 to Plate			0.032	pF
Grid No.3 to Plate			3	pF
Grid No.1 to Cathode, Heater, Grid No.2, Grid No.3 and Internal Shield			6.5	pF
Grid No.3 to Cathode, Heater, Grid No.1, Grid No.2, Plate, and Internal Shield			7.5	pF
Grid No.1 to Grid No.3			0.12	pF
Plate of Unit No.1 to Plate of Unit No.2			0.13	pF

Refer to chart at end of section.

6U5

Refer to chart at end of section.

6U7G

Refer to chart at end of section.

6U8

For replacement use type 6U8A/6KD8.

For replacement use type 6U8A/6KD8.

6U8A/ 6KD8

5U8, 9U8A

MEDIUM-MU TRIODE— SHARP-CUTOFF PENTODE

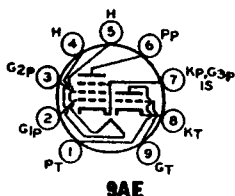

SAE

Miniature types used as combined oscillator and mixer tube in color and black-and-white television receivers utilizing an intermediate frequency in the order of 40 MHz. Outlines section, 6B; require miniature 9-contact socket. Type 5U8 is identical with type 6U8A/6KD8 except for heater ratings.

	5U8	6U8A/6KD8	9U8A	
Heater Voltage (ac/dc)	4.7	6.3	9.45	volts
Heater Current	0.6	0.45	0.3	ampere
Heater Warm-up Time (Average)	11	11	11	seconds
Heater-Cathode Voltage:				
Peak value		±200 max	±200 max	volts
Average value		100 max	100 max	volts
Direct Interelectrode Capacitances:				
Triode Unit:				
Grid to Plate		1.8	1.8	pF
Grid to Cathode, Heater, Pentode Cathode, Pentode Grid No.3, and Internal Shield		2.8	2.8	pF
Plate to Cathode, Heater, Pentode Cathode, Pentode Grid No.3, and Internal Shield		1.5	2	pF
Pentode Unit:				
Grid No.1 to Plate		0.010 max	0.006 max	pF
Grid No.1 to Cathode, Heater, Grid No.2, Grid No.3, and Internal Shield		5	5	pF
Plate to Cathode, Heater, Grid No.2, Grid No.3, and Internal Shield		2.6	3.5	pF
Triode Cathode to Heater		3	3*	pF
Pentode Cathode, Pentode Grid No.3, and Internal Shield		3	3*	pF
Pentode Grid No.1 to Triode Plate		0.2 max	0.2 max	pF
Pentode Plate to Triode Plate		0.1 max	0.02 max	pF

* With external shield connected to pin 4 except as noted.

• With external shield connected to pin 6.

Class A₁ Amplifier

MAXIMUM RATINGS (Design-Maximum Values)	Triode Unit	Pentode Unit	
Plate Voltage	330	330	volts
Grid-No.2 (Screen-Grid) Supply Voltage	—	330	volts
Grid-No.2 Voltage	—	See curve page 300	volts
Grid-No.1 (Control-Grid) Voltage, Positive-bias value	0	0	volts
Plate Dissipation	2.5	3	watts
Grid-No.2 Input:			
For grid-No.2 voltages up to 165 volts	—	0.55	watt
For grid-No.2 voltages between 165 and 330 volts	—	See curve page 300	

CHARACTERISTICS

Plate Voltage	125	125	volts
Grid-No.2 Voltage	—	110	volts
Grid-No.1 Voltage	—1	—1	volts
Amplification Factor	40	—	
Plate Resistance (Approx.)	—	0.2	megohm
Transconductance	7500	5000	μmhos
Plate Current	13.5	9.5	mA
Grid-No.2 Current	—	3.5	mA
Grid-No.1 Voltage (Approx.) for plate current of 20 μA	—9	—8	volts

6U9/ECF201

Refer to chart at end of section.

6U10

THREE-UNIT TRIODE

Duodecax type used in amplifier applications. Units No.1 and No.3 are medium-μ triode units, and unit No.2 is a high-μ triode unit. Outlines section, 8A; requires duodecax 12-contact socket. Heater: volts (ac/dc), 6.3; amperes, 0.6; warm-up time (average), 11 seconds; maximum heater-cathode volts, ±275 (peak) for units 1 and 3; ±200 (peak) for unit 2; 100 (average) for each unit.

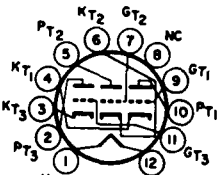

12FE

Class A₁ Amplifier

MAXIMUM RATINGS (Design-Maximum Values)	Units Nos. 1 and 3	Unit No.2	
Plate Voltage	330	330	volts
DC Grid Voltage:			
Positive-bias value	0	0	volts
Negative-bias value	50	50	volts
Average Cathode Current	20	—	mA
Plate Dissipation	2	1	watts
CHARACTERISTICS			
Plate Voltage	200	200	volts
Grid Voltage	—6	—1.5	volts
Amplification Factor	17.5	90	
Plate Resistance (Approx.)	7700	61000	ohms
Transconductance	2300	1600	μmhos
Plate Current	9.6	1.2	mA
Grid Voltage (Approx.):			
For plate current of 100 μA	—15	—	volts
For plate current of 35 μA	—	—3	volts

MAXIMUM CIRCUIT VALUES

Grid-Circuit Resistance:			
For fixed-bias operation	1	0.5	megohm
For cathode-bias operation	2.2	1 ^o	megohms

* This value may reach 10 megohms provided the plate-supply voltage and load resistance are such that the plate dissipation can never exceed 0.5 watt.

6V3A

Refer to chart at end of section.

6V6 6V6GTA

12V6GT

BEAM POWER TUBE

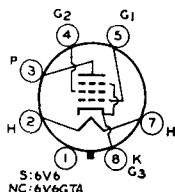

7AC

Metal type 6V6 and glass octal type 6V6GTA are used as output amplifiers in automobile, battery-operated, and other receivers in which reduced plate-current drain is desirable. Outlines section, 2B and 13D, respectively; require octal socket. These tubes are equivalent in performance to type 6AQ5A. Refer to type 6AQ5A for average plate characteristic curves. Type 12V6GT is identical with type 6V6GTA except for heater ratings.

	6V6	6V6GTA	12V6GT	
Heater Voltage (ac/dc)	6.3	6.3	12.6	volts
Heater Current	0.45	0.45	0.225	ampere
Heater Warm-up Time (Average)	—	11	—	seconds
Heater-Cathode Voltage:				
Peak value	±200 max	±200 max	±200 max	volts
Average value	100 max	100 max	100 max	volts
Direct Interelectrode Capacitances (Approx.):		6V6 ^o	6V6GTA	
Grid No.1 to Plate		0.3	0.7	pF
Grid No.1 to Cathode, Heater, Grid No.2, and Grid No.3		10	9	pF
Plate to Cathode, Heater, Grid No.2, and Grid No.3		11	7.5	pF

^o With shell connected to cathode.

Class A₁ Amplifier

MAXIMUM RATINGS (Design-Maximum Values)

Plate Voltage	350	volts
Grid-No.2 (Screen-Grid) Voltage	315	volts
Plate Dissipation	14	watts
Grid-No.2 Input	2.2	watts

TYPICAL OPERATION

Plate Voltage	180	250	315	volts
Grid-No.2 Voltage	180	250	225	volts
Grid-No.1 (Control-Grid) Voltage	-8.5	-12.5	-13	volts
Peak AF Grid-No.1 Voltage	8.5	12.5	13	volts
Zero-Signal Plate Current	29	45	34	mA
Maximum-Signal Plate Current	30	47	35	mA
Zero-Signal Grid-No.2 Current	3	4.5	2.2	mA
Maximum-Signal Grid-No.2 Current	4	7	6	mA
Plate Resistance (Approx.)	50000	50000	80000	ohms
Transconductance	3700	4100	3750	μmhos
Load Resistance	5500	5000	8500	ohms
Total Harmonic Distortion	8	8	12	per cent
Maximum-Signal Power Output	2	4.5	5.5	watts

CHARACTERISTICS (Triode Connection)▲

Plate Voltage	250	volts
Grid-No.1 (Control-Grid) Voltage	-12.5	volts
Amplification Factor	9.8	
Plate Resistance (Approx.)	1960	ohms
Transconductance	5000	μmhos
Plate Current	49.5	mA
Grid-No.1 Voltage (Approx.) for plate current of 0.5 mA	-36	volts

▲ Grid No.2 connected to plate.

Push-Pull Class A₁ Amplifier

MAXIMUM RATINGS (Same as for Class A₁ Amplifier)

TYPICAL OPERATION (Values are for two tubes)

Plate Voltage	250	285	volts
Grid-No.2 Voltage	250	285	volts
Grid-No.1 (Control-Grid) Voltage	-15	-19	volts
Peak AF Grid-No.1-to-Grid-No.1 Voltage	30	38	volts
Zero-Signal Plate Current	70	70	mA
Maximum-Signal Plate Current	79	92	mA
Zero-Signal Grid-No.2 Current	5	4	mA
Maximum-Signal Grid-No.2 Current	13	13.5	mA

Effective Load Resistance (Plate-to-Plate)	10000	8000	ohms
Total Harmonic Distortion	5	3.5	per cent
Maximum-Signal Power Output	10	14	watts

MAXIMUM CIRCUIT VALUES

Grid-No.1-Circuit Resistance:			
For fixed-bias operation		0.1	megohm
For cathode-bias operation		0.5	megohm

Vertical-Deflection Amplifier (Triode Connection)^A

For operation in a 525-line, 30-frame system

MAXIMUM RATINGS (Design-Maximum Values)

DC Plate Voltage	350	volts
Peak Positive-Pulse Plate Voltage#	1200	volts
Peak Negative-Pulse Grid-No.1 (Control-Grid) Voltage	275	volts
Peak Cathode Current	115	mA
Average Cathode Current	40	mA
Plate Dissipation	10	watts

MAXIMUM CIRCUIT VALUE

Grid-No.1-Circuit Resistance, for cathode-bias operation	2.2	megohms
----------------------------------------------------------------	-----	---------

^A Grid No.2 connected to plate.

Pulse duration must not exceed 15% of a vertical scanning cycle (2.5 milliseconds).

- 6V6GT** Refer to chart at end of section.
- 6V6GTY** Refer to chart at end of section.
- 6V7G** Refer to chart at end of section.
- 6W4GT** Refer to chart at end of section.

6W6GT

12W6GT

BEAM POWER TUBE

Glass octal type used in the audio output stage of radio and color and black-and-white television receivers. Triode-connected, it is used as a vertical-deflection amplifier in television receivers. Outlines section, 13D; requires octal socket. This type may be supplied with pin No.1 omitted. Type 12W6GT is identical with type 6W6GT except for heater ratings.

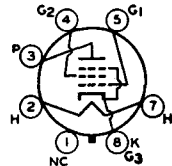

TAC

	6W6GT	12W6GT	
Heater Voltage (ac/dc)	6.3	12.6	volts
Heater Current	1.2	0.6	ampere
Heater Warm-up Time (Average)	—	11	seconds
Heater-Cathode Voltage:			
Peak value	±200 max	{ +200 max -300 max +100 max -200 max	volts
Average value	100 max		volts
Direct Interelectrode Capacitances (Approx.):			
Grid No.1 to Plate		0.8	pF
Grid No.1 to Cathode, Heater, Grid No.2, and Grid No.3		15	pF
Plate to Cathode, Heater, Grid No.2, and Grid No.3		9	pF

Class A₁ Amplifier

MAXIMUM RATINGS (Design-Maximum Values)

Plate Voltage	330	volts
Grid-No.2 (Screen-Grid) Voltage	165	volts
Plate Dissipation	12	watts
Grid-No.2 Input	1.35	watts

TYPICAL OPERATION

Plate Supply Voltage	110	200	volts
Grid-No.2 Supply Voltage	110	125	volts
Grid-No.1 (Control-Grid) Voltage	-7.5	—	volts
Cathode-Bias Resistor	—	180	ohms
Peak AF Grid-No.1 Voltage	7.5	8.5	volts
Zero-Signal Plate Current	49	46	mA
Maximum-Signal Plate Current	50	47	mA
Zero-Signal Grid-No.2 Current	4	2.2	mA
Maximum-Signal Grid-No.2 Current	10	8.5	mA
Plate Resistance (Approx.)	13000	28000	ohms

Transconductance	8000	8000	μ mos
Load Resistance	2000	4000	ohms
Total Harmonic Distortion (Approx.)	10	10	per cent
Maximum-Signal Power Output	2.1	3.8	watts

CHARACTERISTICS (Triode Connection)*

Plate Voltage	225	volts
Grid-No.1 Voltage	-30	volts
Amplification Factor	6.2	
Plate Resistance (Approx.)	1600	ohms
Transconductance	3800	μ mos
Plate Current	22	mA
Grid No.1 Voltage (Approx.) for plate current of 0.5 mA	-42	volts

MAXIMUM CIRCUIT VALUES

Grid-No.1 Circuit Resistance:		
For fixed-bias operation	0.1	megohm
For cathode-bias operation	0.5	megohm

* Grid No.2 connected to plate.

Vertical-Deflection Amplifier

For operation in a 525-line, 30-frame system

MAXIMUM RATINGS (Design-Maximum Values)

	Triode Connection*	Pentode Connection	
DC Plate Voltage	330	330	volts
Peak Positive-Pulse Plate Voltage#	1200	1500	volts
DC Grid No.2 (Screen-Grid) Voltage	—	165	volts
Peak Negative-Pulse Grid-No.1 Voltage	275	275	volts
Peak Cathode Current	195	195	mA
Average Cathode Current	65	65	mA
Plate Dissipation	8.5	8	watts
Grid-No.2 Input	—	1.2	watts

MAXIMUM CIRCUIT VALUE

Grid-No.1-Circuit Resistance, for cathode-bias operation	2.2	2.2	megohms
----------------------------------------------------------------	-----	-----	---------

* Grid No.2 connected to plate.

Pulse duration must not exceed 15% of a vertical scanning cycle (2.5 milliseconds).

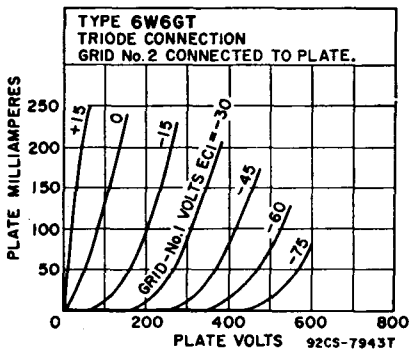
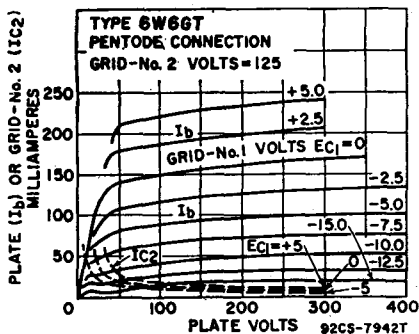

Refer to chart at end of section.

6W7G

6X4

12X4

FULL-WAVE VACUUM RECTIFIER

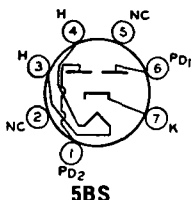

Miniature type used in power supply of automobile and ac-operated radio receivers. Equivalent in performance to larger type 6X5GT. Outlines section, 5D; requires miniature 7-contact socket. This tube, like other power-handling tubes, should be adequately ventilated. For discussion of Rating Chart and Operation

Characteristics, refer to Interpretation of Tube Data. Type 12X4 is identical with type 6X4 except for heater ratings.

	6X4	12X4	
Heater Voltage (ac/dc)	6.3 ^A	12.6	volts
Heater Current	0.6	0.3	ampere
Heater-Cathode Voltage:			
Peak value	+200, -450 max		volts
Average value	100 max		volts

^A When the heater is operated from a 3-cell (nominal-6-volt) storage-battery source, the permissible heater-voltage range is from 5 to 8 volts.

Full-Wave Rectifier

MAXIMUM RATINGS (Design-Maximum Values)

Peak Inverse Plate Voltage	1250	volts
Steady-State Peak Plate Current (Per Plate)	245	mA
AC Plate Supply Voltage (Per Plate, rms)	See Rating Chart	
DC Output Voltage (At filter input)†	350	volts
Average Output Current (Each plate)†	45	mA
Hot-Switching Transient Plate Current	#	

† This rating applies when the 6X4 is used in vibrator operation with a minimum duty cycle of 75 per cent.

If hot-switching is regularly required in operation, the use of choke-input circuits is recommended. Such circuits limit the hot-switching current to a value no higher than that of the peak plate current. When capacitor-input circuits are used, a maximum peak current value per plate of 1.1 amperes during the initial cycles of the hot-switching transient should not be exceeded.

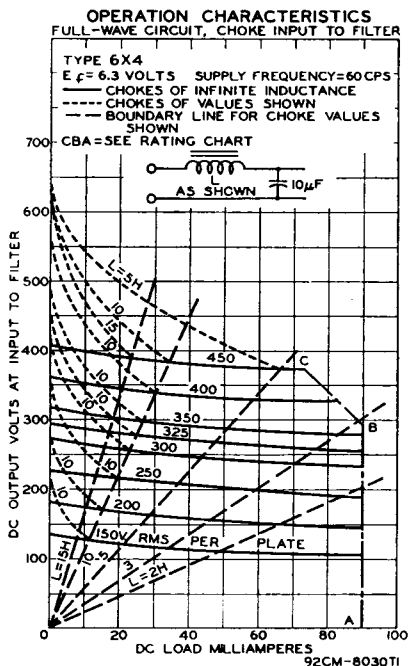
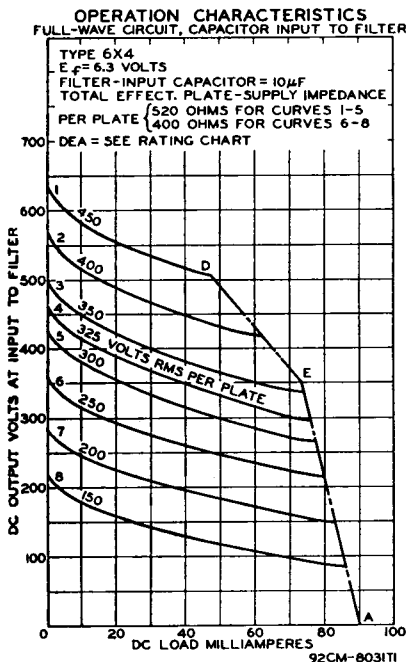

TYPICAL OPERATION

Filter Input

AC Plate Supply Voltage (Each plate, rms) ..	325	400	
Filter Input Capacitor	10	—	10
Effective Plate Supply Impedance (Each plate) ..	525	—	ohms
Filter Input Choke	—	10	henries
Average Output Current	70	70	mA
DC Output Voltage at Input to Filter (Approx.)	310	340	volts

Sine Wave Operation Capacitor Choke	325	400	
Vibrator Operation Capacitor	—	—	volts
	10	—	µF
	525	—	ohms
	—	10	henries
	70	70	mA
	310	340	volts

• AC plate supply voltage is measured without load.

RATING CHART

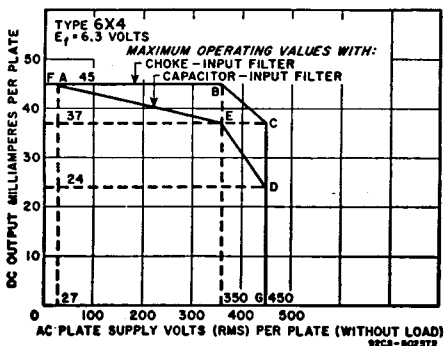

Refer to chart at end of section.

6X4W

Refer to chart at end of section.

6X5

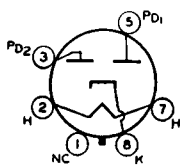

6S

**FULL-WAVE
VACUUM RECTIFIER**

6X5GT

Glass octal type used in power supply of automobile and ac-operated receivers. Outlines section, 13D; requires octal socket. This type may be supplied with pin No.1 omitted. For maximum ratings, and typical operation, refer to type 6X4.

Refer to chart at end of section.

6X8

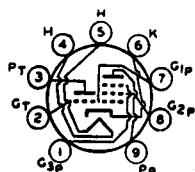

9AK

**MEDIUM-MU TRIODE—
SHARP-CUTOFF PENTODE**

6X8A

5X8, 19X8

Miniature type used as combined oscillator and mixer tube in television receivers utilizing an intermediate frequency in the order of 40 MHz and in AM/FM receivers. Outlines section, 6B; requires miniature 9-contact socket. Types 5X8 and 19X8 are identical with type 6X8A except for heater ratings.

	5X8	6X8A	19X8	
Heater Voltage (ac/dc)	4.7	6.3	18.4	volts
Heater Current	0.6	0.45	0.15	amperes
Heater Warm-up Time (Average)	11	11	—	seconds
Heater-Cathode Voltage:				
Peak value	±200 max	±200 max	±200 max	volts
Average value	100 max	100 max	100 max	volts
Direct Interelectrode Capacitances:				
Triode Unit:				
Grid to Plate	1.5	1.5		pF
Grid to Cathode and Heater	2	2.4		pF
Plate to Cathode and Heater	0.5	1		pF
Pentode Unit:				
Grid No.1 to Plate	0.09 max	0.06 max		pF
Grid No.1 to Cathode, Heater, Grid No.2, and Grid No.3	4.6	4.8		pF
Plate to Cathode, Heater, Grid No.2, and Grid No.3	0.9	1.6		pF
Pentode Grid No.1 to Triode Plate	0.05 max	0.04 max		pF
Pentode Plate to Triode Plate	0.05 max	0.008 max		pF
Heater to Cathode	6.5	6.5*		pF

^Δ With external shield connected to cathode except as noted.

• With external shield connected to pentode plate.

Class A₁ Amplifier

MAXIMUM RATINGS (Design-Maximum Values)

	Triode Unit	Pentode Unit	
Plate Voltage	275	275	volts
Grid No.2 (Screen-Grid) Supply Voltage	—	275	volts
Grid-No.2 Voltage	—	See curve page 300	
Grid-No.1 (Control-Grid) Voltage, Positive-bias value	0	0	volts
Plate Dissipation	1.7	2.3	watts
Grid-No.2 Input:			
For grid-No.2 voltages up to 137.5 volts	—	0.45	watt
For grid-No.2 voltages between 137.5 and 275 volts	—	See curve page 300	

CHARACTERISTICS

Plate Voltage	125	125	volts
Grid No.3	Connected to cathode at socket		
Grid-No.2 Voltage	—	125	volts
Grid-No.1 Voltage	—1	—1	volt
Amplification Factor	40	—	
Plate Resistance (Approx.)	6000	300000	ohms
Transconductance	6500	5500	μmhos
Plate Current	12	9	mA
Grid-No.2 Current	—	2.2	mA
Grid-No.1 Voltage (Approx.) for plate current of 20 μA	—7	—6.5	volts

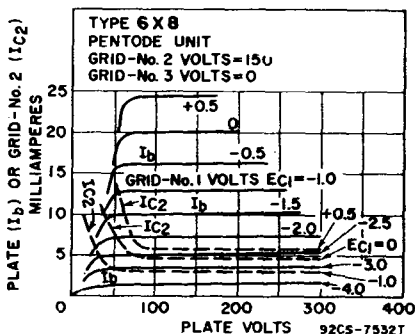
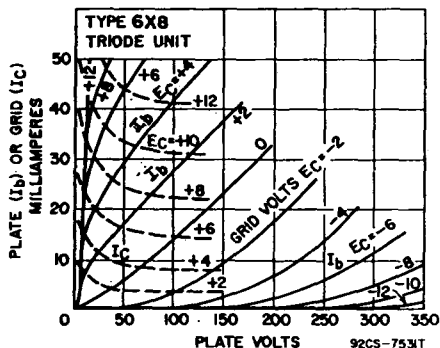

6X9/ ECF200

HIGH-MU TRIODE— SHARP-CUTOFF PENTODE

Miniature type used as if-amplifier tube in television receivers. Outlines section 6B, except has 10-pin base; requires miniature 10-contact socket.

Heater Voltage	6.3	volts
Heater Current	0.41	ampere
Peak Heater-Cathode Voltage	±150 max	volts
Direct Interelectrode Capacitances:		
Triode Unit:		
Plate to All Other Elements (except grid)	3	pF
Grid to All Other Elements (except plate)	2.5	pF
Plate to Grid	2	pF
Pentode Unit:		
Plate to All Other Elements (except grid No.1)	3.5	pF
Grid No.1 to All Other Elements (except plate)	6.5	pF
Grid No.1 to Cathode	4	pF
Plate to Grid No.1	<6.5	pF
Grid No.1 to Grid No.2	1.8	pF

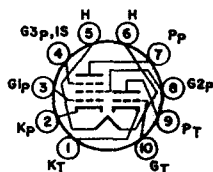

10K

Pentode Grid No.1 to Triode Plate	15	pF
Pentode Grid No.1 to Triode Grid	<1.2	pF
Pentode Plate to Triode Plate	<1.5	pF

Class A₁ Amplifier

MAXIMUM RATINGS (Design-Maximum Values)	Triode Unit	Pentode Unit	
Plate Supply Voltage	550	550	volts
Plate Voltage	250	250	volts
Peak Plate Voltage*	600	—	volts
Grid-No.2 (Screen-Grid) Supply Voltage	—	550	volts
Grid-No.2 Voltage	—	250	volts
Cathode Current	18	18	mA
Plate Dissipation	1.5	2.1	watts
Grid-No.2 Input	—	0.7	watt

CHARACTERISTICS

Plate Voltage	170	160	volts
Grid-No.3 (Suppressor-Grid) Voltage	—	0	volts
Grid-No.2 Voltage	—	135	volts
Grid-No.1 (Control-Grid) Voltage	-1	-1.7	volts
Mu Factor, Grid-No.1 to Grid-No.2	—	55	
Amplification Factor	55	—	
Transconductance	4800	14000	μmhos
Plate Current	8.5	13	mA
Grid-No.2 Current	—	5	mA

MAXIMUM CIRCUIT VALUES

Grid-No.1-Circuit Resistance	1	1	megohm
------------------------------------	---	---	--------

* With a maximum duty factor of 0.18 and maximum pulse duration of 18 microseconds.

Refer to chart at end of section.

6Y5

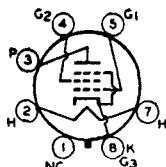

7AC

BEAM POWER TUBE

**6Y6GA/
6Y6G**

Glass octal type used as output amplifier in radio receivers and in rf-operated, high-voltage power supplies in television equipment. Outlines section, 19B; requires octal socket.

Heater Voltage (ac/dc)	6.3	volts
Heater Current	1.25	amperes
Peak Heater-Cathode Voltage	±180 max	volts
Direct Interelectrode Capacitances (Approx.):		
Grid No.1 to Plate	0.7	pF
Grid No.1 to Cathode, Heater, Grid No.2, and Grid No.3	12	pF
Plate to Cathode, Heater, Grid No.2, and Grid No.3	7.5	pF

Class A₁ Amplifier

MAXIMUM RATINGS (Design-Center Values)		
Plate Voltage	200	volts
Grid-No.2 (Screen-Grid) Supply Voltage	200	volts
Grid-No.2 Voltage	See curve page 300	
Plate Dissipation	12.5	watts
Grid-No.2 Input:		
For grid-No.2 voltages up to 100 volts	1.75	watts
For grid-No.2 voltages between 100 and 200 volts	See curve page 300	

TYPICAL OPERATION

Plate Voltage	135	200	volts
Grid-No.2 Voltage	135	135	volts
Grid-No.1 (Control-Grid) Voltage	-13.5	-14	volts
Peak AF Grid-No.1 Voltage	13.5	14	volts
Zero-Signal Plate Current	58	61	mA
Maximum-Signal Plate Current	60	66	mA
Zero-Signal Grid-No.2 Current	3.5	2.2	mA
Maximum-Signal Grid-No.2 Current	11.5	9	mA
Plate Resistance (Approx.)	9300	18300	ohms
Transconductance	7000	7100	μmhos
Load Resistance	2000	2600	ohms
Total Harmonic Distortion	10	10	per cent
Maximum-Signal Power Output	3.6	6	watts

MAXIMUM CIRCUIT VALUES

Grid-No.1-Circuit Resistance:		
For fixed-bias operation	0.1	megohm
For cathode-bias operation	0.5	megohm

6Y6GT

For replacement use type 6Y6GA/6Y6G.

6Y7G

Refer to chart at end of section.

6Y9Refer to chart at end of section.
For replacement use type 6Y9/EFL200.**6Y9/EFL200**

17Y9

DUAL PENTODE

Miniature type for use in color and black-and-white television receiver applications. Unit No. 1 is used as a video output pentode, and unit No. 2 as a sound if amplifier, agc amplifier, or sync separator. Outlines section, 6L, except has 10-pin base; requires miniature 10-contact socket. Type 17Y9 is identical with type 6Y9/EFL200 except for heater ratings.

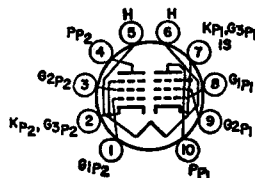

10L

	6Y9/ EFL200	17Y9	
Heater Voltage	6.3	16.5	volts
Heater Current	0.8	0.3	ampere
Peak Heater-Cathode Voltage	±200	±200	volts
Direct Interelectrode Capacitances:			
Unit No.1:			
Plate to All Other Elements (except grid No.1)		7	pF
Grid No.1 to All Other Elements (except plate)		12	pF
Plate to Grid No.1		95	pF
Unit No.2:			
Plate to All Other Elements (except grid No.1)		11	pF
Grid No.1 to All Other Elements (except plate)		10	pF
Plate to Grid No.1		140	pF
Grid No.1 to Heater		<100	pF
Plate to Plate		<150	pF
Grid to Grid		<10	pF
Plate (Unit No.1) to Grid No.1 (Unit No.2)		<100	pF
Plate (Unit No.2) to Grid No.1 (Unit No.2)		<5	pF

Class A₁ Amplifier

MAXIMUM RATINGS (Design-Maximum Values)	Unit No.1	Unit No.2	
Plate Supply Voltage	550	550	volts
Plate Voltage	250	250	volts
Grid-No.2 (Screen-Grid) Supply Voltage	550	550	volts
Grid-No.2 Voltage	250	250	volts
Cathode Current	60	15	mA
Plate Dissipation	5	1.5	watts
Grid-No.2 Input	2.5	0.5	watts
CHARACTERISTICS			
Plate Voltage	170	150	volts
Grid-No.2 Voltage	170	150	volts
Grid-No.1 (Control-Grid) Voltage	-2.6	-2.3	volts
Mu Factor, Grid-No.1 to Grid-No.2	38	35	
Internal Resistance	40	160	kohms
Transconductance	21000	8500	μmhos
Plate Current	30	10	mA
Grid-No.2 Current	6.5	3	mA

MAXIMUM CIRCUIT VALUES

Grid-No.1-Circuit Resistance	1	1	megohm
------------------------------	---	---	--------

6Z4Refer to chart at end of section.
For replacement use type 84/6Z4.**6Z5**

Refer to chart at end of section.

6Z7G

Refer to chart at end of section.

6Z10

Refer to chart at end of section.

**POWER PENTODE—
GATED-BEAM
DISCRIMINATOR**

6Z10/6J10

10Z10, 13Z10/13J10

Duodecar types used as a combined limiter, discriminator, and audio power-output tube in FM radio and television receivers. Outlines section, 8C; require duodecar 12-contact socket. Types 10Z10, and 13Z10/13J10 are identical with type 6Z10/6J10 except for heater ratings.

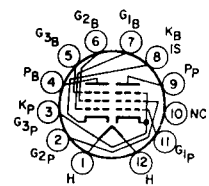

12B7

	6Z10/6J10	10Z10	13Z10/13J10	
Heater Voltage (ac/dc)	6.3	10	13.2	volts
Heater Current	0.95	0.6	0.45	ampere
Heater Warm-up Time (Average)	—	11	11	seconds
Heater-Cathode Voltage:				
Peak value	±200 max	±200 max	±200 max	volts
Average value	100 max	100 max	100 max	volts

Direct Interelectrode Capacitances:

Pentode Unit:

Grid No.1 to Grid No.3	0.009	pF
Grid No.1 to Cathode, Heater, Grid No.2, Grid No.3, Plate, and Internal Shield	4.4	pF
Grid No.3 to Cathode, Heater, Grid No.1, Grid No.2, Plate, and Internal Shield	3.2	pF

Beam Power Unit:

Grid No.1 to Plate	0.22	pF
Grid No.1 to Cathode, Heater, Grid No.2, and Grid No.3	11	pF
Plate to Cathode, Heater, Grid No.2, and Grid No.3	7.5	pF

Gated-Beam Unit as Limiter and Discriminator

MAXIMUM RATINGS (Design-Maximum Values)

Plate Supply Voltage	330	volts
Grid-No.2 Voltage	330	volts
Grid-No.1 Voltage, Peak positive value	60	volts
Average Cathode Current	13	mA

CHARACTERISTICS

	135	135	135	
Plate Voltage	135	135	135	volts
Grid-No.3 (Suppressor-Grid) Voltage	4	4	0	volts
Grid-No.2 (Screen-Grid) Supply Voltage	—	280	280	volts
Grid-No.2 Voltage	75	—	—	volts
Grid No. 1 (Control-Grid) Voltage	0	0	0	volts
Grid-No.2 Resistor	—	33	33	kohms
Transconductance, Grid No.1 to Plate	—	—	360	μmhos
Transconductance, Grid No.3 to Plate	—	—	700	μmhos
Average Plate Current	—	5	—	mA
Grid-No.2 Current	4.5	—	—	mA
Grid No.1 Voltage (Approx.) for plate current of 20 μA	—	—	—4	volts
Grid No.3 Voltage (Approx.) for plate current of 20 μA	—	—	—4	volts

Pentode Unit as Class A₁ Amplifier

MAXIMUM RATINGS (Design-Maximum Values)

Plate Voltage	275	volts
Grid-No.2 (Screen-Grid) Voltage	275	volts
Plate Dissipation	10	watts
Grid-No.2 Input	2	watts

TYPICAL OPERATION

Plate Voltage	250	volts
Grid-No.2 Voltage	250	volts
Grid-No.1 (Control-Grid) Voltage	—8	volts
Peak AF Grid-No.1 Voltage	8	volts
Zero-Signal Plate Current	35	mA
Maximum-Signal Plate Current	39	mA
Zero-Signal Grid-No.2 Current	3	mA
Maximum-Signal Grid-No.2 Current	13	mA
Plate Resistance (Approx.)	0.1	megohm
Transconductance	6500	μmhos
Load Resistance	5000	ohms
Total Harmonic Distortion (Approx.)	8.5	per cent
Maximum-Signal Power Output	4.2	watts

MAXIMUM CIRCUIT VALUES

Grid-No.1-Circuit Resistance:		
For fixed-bias operation	0.25	megohm
For cathode-bias operation	0.5	megohm

6ZY5G	Refer to chart at end of section.
7A4	Refer to chart at end of section.
7A5	Refer to chart at end of section.
7A6	Refer to chart at end of section.
7A7	Refer to chart at end of section.
7A8	Refer to chart at end of section.
7AD7	Refer to chart at end of section.
7AF7	Refer to chart at end of section.
7AG7	Refer to chart at end of section.
7AH7	Refer to chart at end of section.
7AU7	Refer to type 12AU7A.
7B4	Refer to chart at end of section.
7B5	Refer to chart at end of section.
7B6	Refer to chart at end of section.
7B7	Refer to chart at end of section.
7B8	Refer to chart at end of section.
7C5	Refer to chart at end of section.
7C6	Refer to chart at end of section.
7C7	Refer to chart at end of section.
7DJ8/PCC88	Refer to chart at end of section.
7E6	Refer to chart at end of section.
7E7	Refer to chart at end of section.
7EY6	Refer to chart at end of section.
7F7	Refer to chart at end of section.
7F8	Refer to chart at end of section.
7G7	Refer to chart at end of section.
7GS7	Refer to type 6GS7.

Refer to chart at end of section.

7H7

Refer to chart at end of section.

7HG8

Refer to type 6HG8/ECF86.

7HG8/PCF86

Refer to chart at end of section.

7J7

Refer to chart at end of section.

7K7

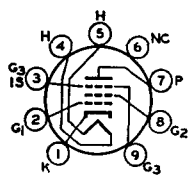

9GK

SHARP-CUTOFF PENTODE

7KY6

Miniature type with frame grid used as video output amplifier in color and black-and-white television receivers. Outlines section, 6E; requires miniature 9-contact socket.

Heater Voltage (ac/dc)	7.3	volts
Heater Current	0.45	ampere
Heater Warm-up Time	11	seconds
Heater-Cathode Voltage:		
Peak value	±200 max	volts
Average value	100 max	volts
Direct Interelectrode Capacitances:		
Grid No.1 to Plate	0.16 max	pF
Grid No.1 to Cathode, Heater, Grid No.2, Grid No.3, and Internal Shield	14	pF
Plate to Cathode, Heater, Grid No.2, Grid No.3, and Internal Shield	6	pF

Class A₁ Amplifier

MAXIMUM RATINGS (Design-Maximum Values)

Plate Voltage	330	volts
Grid-No.2 (Screen-Grid) Supply Voltage	330	volts
Grid-No.2 Voltage	See curve page 300	
Grid-No.1 (Control-Grid) Voltage, Positive-bias value	0	volts
Plate Dissipation	9	watts
Grid-No.2 Input:		
For grid-No.2 voltages up to 165 volts	1	watt
For grid-No.2 voltages between 165 and 330 volts	See curve page 300	

CHARACTERISTICS

Plate Supply Voltage	200	volts
Grid-No.3 Voltage	Connected to cathode	at socket
Grid-No.2 Supply Voltage	135	volts
Grid-No.1 Supply Voltage	0	volts

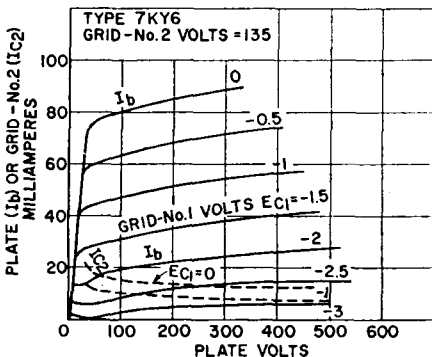

Cathode-Bias Resistor	47	ohms
Plate Resistance (Approx.)	40000	ohms
Transconductance	30000	μ hos
Plate Current	30	mA
Grid-No.2 Current	5.2	mA
Grid-No.1 Voltage (Approx.) for plate current of 100 μ A	—4.5	volts

MAXIMUM CIRCUIT VALUES

Grid-No.1-Circuit Resistance:		
For fixed-bias operation	0.1	megohm
For cathode-bias operation	0.25	megohm

7KZ6	Refer to chart at end of section.
7L7	Refer to chart at end of section.
7N7	Refer to chart at end of section.
7Q7	Refer to chart at end of section.
7R7	Refer to chart at end of section.
7S7	Refer to chart at end of section.
7V7	Refer to chart at end of section.
7W7	Refer to chart at end of section.
7X7	Refer to chart at end of section.
7Y4	Refer to chart at end of section.
7Z4	Refer to chart at end of section.
8A8	For replacement use type 9A8/PCF80.
8AC10	Refer to type 6AC10.
8AL9	Refer to chart at end of section.
8AR11	Refer to type 6AR11.
8AU8	Refer to chart at end of section.
8AW8A	Refer to type 6AW8A.
8B8	Refer to type 16A8/PCL82.
8B10	Refer to type 6B10.
8BA8A	Refer to type 6BA8A.
8BA11	Refer to type 6BA11.
8BH8	Refer to chart at end of section.

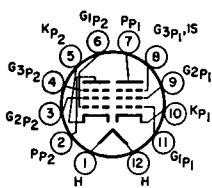

12FU

DUAL PENTODE

8BM11

Duodecar type used as if amplifier in television receivers. Unit No.1 is a softemote-cutoff pentode, and unit No. 2 is a sharp-cutoff pentode. Outlines section, 8B; requires duodecar 12-contact socket. Heater: volts (ac/dc), 8.4; amperes, 0.45; maximum heater-cathode volts, ± 200 peak, 100 average.

Class A₁ Amplifier

MAXIMUM RATINGS (Design-Maximum Values)	Unit No.1	Unit No.2	
Plate Voltage	160	160	volts
Grid-No.3 (Suppressor-Grid) Voltage	0	0	volts
Grid-No.2 (Screen-Grid) Voltage	160	160	volts
Grid-No.1 (Control-Grid) Voltage, Positive-bias value	0	0	volts
Plate Dissipation	2.2	2.2	watts
Grid-No.2 Input	0.55	0.55	watt
CHARACTERISTICS			
Plate Supply Voltage	125	125	volts
Grid No.3	Connected to cathode at socket		
Grid-No.2 Voltage	125	125	volts
Cathode-Bias Resistor	56	120	ohms
Plate Resistance (Approx.)	220000	300000	ohms
Transconductance	8800	8500	μ mhos
Plate Current	14	9	mA
Grid-No.2 Current	3.6	2.5	mA
Grid-No.1 Voltage (Approx.) for plate current of 20 μ A	—	-5.5	volts
Grid-No.1 Voltage (Approx.) for transconductance of 50 μ mho	-16.5	—	volts
MAXIMUM CIRCUIT VALUES			
Grid-No.1-Circuit Resistance, for cathode-bias operation	1	0.25	megohm

Refer to type 6BN8.

8BN8

Refer to chart at end of section.

8BN11

Refer to type 6BQ5.

8BQ5

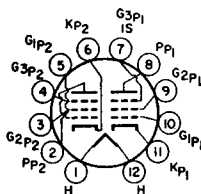

12DM

SEMIREMOTE-CUTOFF DUAL PENTODE

8BQ11

11BQ11, 16BQ11

Duodecar type used as intermediate-frequency amplifier in television receivers. Outlines section, 8B; requires duodecar 12-contact socket. Types 11BQ11 and 16BQ11 are identical with type 8BQ11 except for heater ratings.

	8BQ11	11BQ11	16BQ11	
Heater Voltage (ac/dc)	8.4	11.2	16	volts
Heater Current	0.6	0.45	0.315	ampere
Heater Warm-up Time (Average)	11	11	11	seconds
Heater-Cathode Voltage:				
Peak value	± 200 max	± 200 max	± 200 max	volts
Average value	100 max	100 max	100 max	volts

Direct Interelectrode Capacitances:

	Unit No.1	Unit No.2	
Grid No.1 to Plate	0.022	0.024	pF
Grid No.1 to Cathode, Heater, Grid No.2, Grid No.3, and Internal Shield	10	—	pF
Plate to Cathode, Heater, Grid No.2, Grid No.3, and Internal Shield	2.8	—	pF
Grid No.1 to Cathode, Heater, Grid No.2, Grid No.3, Grid No.3 of Unit No.1, and Internal Shield	—	11	pF

Plate to Cathode, Heater, Grid No.2, Grid No.3, Grid No.3 of Unit No.1, and Internal Shield	2.8	pF
Plate of Unit No.1 to Plate of Unit No.2	0.015	pF
Grid No.1 of Unit No.1 to Plate of Unit No.2	0.002	pF
Grid No.1 of Unit No.2 to Plate of Unit No.1	0.008	pF
Grid No.1 of Unit No.1 to Grid No.1 of Unit No.2	0.002	pF

Class A₁ Amplifier

MAXIMUM RATINGS (Design-Maximum Values)	Unit No.1	Unit No.2	
Plate Voltage			
Grid-No.3 (Suppressor-Grid) Voltage	330	330	volts
Grid-No.2 (Screen-Grid) Supply Voltage	0	0	volts
Grid-No.2 Voltage	330	330	volts
Grid-No.1 (Control-Grid) Voltage, Positive-bias value	See curve page 300		
Plate Dissipation	0	0	volts
Grid-No.2 Input:			
For grid-No.2 voltages up to 165 volts	3.1	3.1	watts
For grid-No.2 voltages between 165 and 330 volts	0.65	0.65	watt
	See curve page 300		

CHARACTERISTICS

Plate Supply Voltage	125	125	volts
Grid No.3	Connected to cathode at socket		
Grid-No.2 Voltage	125	125	volts
Cathode-Bias Resistor	56	56	ohms
Plate Resistance (Approx.)	0.2	0.2	megohm
Transconductance	10500	13000	μmhos
Plate Current	11	11	mA
Grid-No.2 Current	3.5	3.8	mA
Grid-No.1 Voltage (Approx.) for plate current of 20 μA	—	—3	volts
Grid-No.1 Voltage (Approx.) for transconductance of 50 μmho	—15	—	volts

MAXIMUM CIRCUIT VALUES

Grid-No.1-Circuit Resistance, for cathode-bias operation	1	0.25	megohm
-------------------------------------------------------------	---	------	--------

8BU11

**MEDIUM-MU TWIN TRIODE—
SHARP-CUTOFF PENTODE**

Duodecar type used in television receiver applications. Outlines section, 8C; requires duodecar 12-contact socket. Heater: volts (ac/dc), 7.8; amperes, 0.6; warm-up time, 11 seconds, maximum heater-cathode volts, ±200 peak, 100 average.

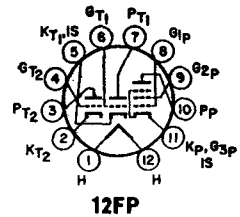

Class A₁ Amplifier

MAXIMUM RATINGS (Design-Maximum Values)	Pentode Unit	Triode Unit	Each
Plate Voltage	330	330	volts
Grid-No.2 (Screen-Grid) Supply Voltage	330	—	volts
Grid-No.2 Voltage	See curve page 300		
Grid-No.1 (Control-Grid) Voltage, Positive-bias value	0	0	volts
Plate Dissipation	2.5	1.8	watts
Grid-No.2 Input:			
For grid-No.2 voltages up to 165 volts	0.55	—	watt
For grid-No.2 voltages between 165 and 330 volts	See curve page 300		

CHARACTERISTICS

Plate Supply Voltage	125	125	volts
Grid-No.2 Voltage	125	—	volts
Grid-No.1 Voltage	—1	—	volts
Cathode-Bias Resistor	—	68	ohms
Amplification Factor	—	43	
Plate Resistance (Approx.)	20000	5000	ohms
Transconductance	7500	8600	μmhos
Plate Current	12	13.5	mA
Grid-No.2 Current	4	—	mA
Grid Voltage (Approx.) for plate current of 100 μA	—	—8	volts
Grid-No.1 Voltage (Approx.) for plate current of 30 μA	—8	—	volts

MAXIMUM CIRCUIT VALUES

Grid-No.1-Circuit Resistance:			
For fixed-bias operation	0.5	0.5	megohm
For cathode-bias operation	1	1	megohm

Refer to chart at end of section.	8CB11
For replacement use type 8FQ7/8CG7.	8CG7
Refer to type 6CM7.	8CM7
Refer to chart at end of section.	8CN7
Refer to type 6CS7.	8CS7
Refer to type 6CW5/EL86.	8CW5/XL86
Refer to type 6CW5.	8CW5
Refer to type 6CX8.	8CX8
Refer to chart at end of section.	8EB8
For replacement use type 8GN8/8EB8.	8EM5
Refer to type 6EM5.	8ET7
Refer to chart at end of section.	8FQ7
Refer to chart at end of section.	8FQ7/8CG7
Refer to type 6FQ7/6CG7.	8GJ7
Refer to chart at end of section.	8GJ7/PCF801
Refer to type 6GJ7/ECF801.	8GN8
Refer to type 6GN8.	8GN8/8EB8
Refer to type 6GU7.	8GU7
Refer to type 6JU8A.	8JU8A
Refer to type 6JV8.	8JV8
Refer to type 6KA8.	8KA8
Refer to type 6LC8.	8LC8
Refer to type 6LT8.	8LT8
Refer to chart at end of section.	9A8

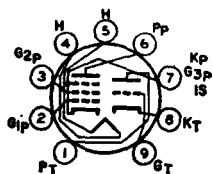

9DC

**MEDIUM-MU TRIODE—
SHARP-CUTOFF PENTODE**

**9A8/
PCF80**

Miniature type used as combined oscillator and mixer tubes in vhf color and black-and-white television receivers. Outlines section, 6B; requires miniature 9-contact socket. Heater: volts (ac/dc), 9; amperes, 0.3; maximum heater-cathode volts, +100, -200 peak; -120 average.

Class A₁ Amplifier

MAXIMUM RATINGS (Design-Center Values)	Triode Unit	Pentode Unit	
Plate Supply Voltage	550	550	volts
Plate Voltage	250	250	volts
Grid-No.2 (Screen-Grid) Voltage	—	175	volts
Cathode Current	14	14	mA
Plate Dissipation	1.5	1.7	watts
Grid-No.2 Input	—	0.5	watt

CHARACTERISTICS

Plate Voltage	100	170	volts
Grid-No.2 Voltage	—	170	volts
Grid-No.1 Voltage	—2	—2	volts
Amplification Factor	20	47*	
Plate Resistance (Approx.)	—	0.4	megohm
Transconductance	5000	6200	μmhos
Plate Current	14	10	mA
Grid-No 2 Current	—	2.8	mA

MAXIMUM CIRCUIT VALUES

Grid-No.1-Circuit Resistance:			
For fixed-bias operation	0.5	0.5	megohm
For cathode-bias operation	0.5	1	megohm

* Grid No.2 to Grid No.1.

9AH9	Refer to chart at end of section.
9AK10	Refer to chart at end of section.
9AM10	Refer to chart at end of section.
9AQ8/PCC85	Refer to chart at end of section.
9AU7	Refer to type 12AU7A.
9BJ11	Refer to chart at end of section.
9BR7	Refer to chart at end of section.
9CL8	Refer to chart at end of section.
9EA8	Refer to chart at end of section.
9GH8A	Refer to type 6GH8A.
9GV8	Refer to chart at end of section.
9GV8/XCL85	Refer to type 6GV8/ECL85.
9JW8/PCF802	Refer to type 6JW8/ECF802.
9KC6	Refer to chart at end of section.

9KX6**SHARP-CUTOFF PENTODE**

Miniature type with frame grid used as video output amplifier in color and black-and-white television receivers. Outlines section, 6E; requires miniature 9-contact socket. Heater: volts, 8.7; amperes, 0.45; warm-up time, 11 seconds; maximum heater-cathode volts, ± 200 peak, 100 average.

**9GK****Class A₁ Amplifier****MAXIMUM RATINGS (Design-Maximum Values)**

Plate Voltage	400	volts
Grid-No.3 (Suppressor-Grid) Voltage, Positive value	0	volts
Grid-No.2 (Screen-Grid) Supply Voltage	330	volts
Grid-No.2 Voltage	See curve page 300	
Grid-No.1 (Control-Grid) Voltage, Positive value	0	volts
Plate Dissipation	11.5	watts
Grid-No.2 Input	1.5	watts

CHARACTERISTICS

Plate Voltage	250	50	volts
Grid-No.3 Voltage	Connected to cathode at socket		
Grid-No.2 Supply Voltage	150	125	volts
Grid-No.1 Voltage	0	0	volts

Cathode-Bias Resistor, Bypassed	56	—	ohms
Plate Resistance (Approx.)	50000	—	ohms
Transconductance (Grid No.1 to Plate)	36000	—	μ mhos
Plate Current	28	70	mA
Grid-No.2 Current	6.5	24	mA
Grid-No.1 Voltage (Approx.) for plate current of 100 μ A	—5.7	—	volts

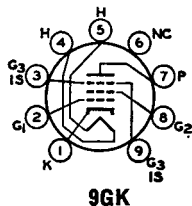
MAXIMUM CIRCUIT VALUES

Grid-No.1-Circuit Resistance:			
For fixed-bias operation		0.1	megohm
For cathode-bias operation		0.25	megohm

Refer to type 6KZ8.	9KZ8
Refer to chart at end of section.	9LA6
Refer to type 6MN8.	9MN8
For replacement use type 10DE7.	9RAL1
Refer to type 6U8A.	9U8A
Refer to chart at end of section.	10
Refer to type 6AL11.	10AL11
Refer to type 6BQ5.	10BQ5
Refer to chart at end of section.	10C8
Refer to chart at end of section.	10CW5
Refer to type 6CW5/EL86.	10CW5/LL86
Refer to type 6DE7.	10DE7
Refer to type 6DR7.	10DR7
Refer to chart at end of section.	10DX8
Refer to type 6DX8/ECL84.	10DX8/LCL84
Refer to chart at end of section.	10EG7
Refer to type 6EM7.	10EM7
Refer to type 6EW7.	10EW7
Refer to chart at end of section.	10GF7
Refer to type 6GF7A.	10GF7A
Refer to type 6GK6.	10GK6
Refer to type 6GN8.	10GN8
Refer to type 6GV8/ECL85.	10GV8/LCL85
Refer to type 6HF8.	10HF8
Refer to chart at end of section.	10JA5
Refer to type 10JA8/10LZ8	10JA8

10JA8/ 10LZ8

HIGH-MU TRIODE— SHARP-CUTOFF PENTODE

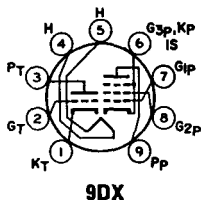

Miniature type used in color and black-and-white television receiver applications. The triode unit is used as a sync separator, sync clipper, and phase inverter; the pentode unit is used as a video amplifier. Outlines section, 6E; requires miniature 9-contact socket.

Heater Voltage (ac/dc)	10.5	volts
Heater Current	0.45	ampere
Heater Warm-up Time	11	seconds
Heater-Cathode Voltage:		
Peak value	±200 max	volts
Average value	100 max	volts
Direct Interelectrode Capacitances:		
Triode Unit:		
Grid to Plate	4	pF
Grid to Cathode, Pentode Cathode, Heater, Pentode Grid No.3, and Internal Shield	2.6	pF
Plate to Cathode, Pentode Cathode, Heater, Pentode Grid No.3, and Internal Shield	2.6	pF
Pentode Unit:		
Grid No.1 to Plate	0.1 max	pF
Grid No.1 to Cathode, Heater, Grid No.2, Grid No.3, and Internal Shield	11	pF
Plate to Cathode, Heater, Grid No.2, Grid No.3, and Internal Shield	4.4	pF
Grid No.1 to Triode Plate	0.005 max	pF
Plate to Triode Grid	0.018 max	pF
Plate to Triode Plate	0.17 max	pF

Class A₁ Amplifier

MAXIMUM RATINGS (Design-Maximum Values)

Plate Voltage	300	volts
Grid-No.2 (Screen-Grid) Supply Voltage	—	330 volts
Grid-No.2 Voltage	—	See curve page 300
Grid-No.1 (Control-Grid) Voltage, Positive-bias value	0	0 volts
Plate Dissipation	1	5 watts
Grid-No.2 Input:		
For Grid-No.2 voltages up to 165 volts	—	1.5 watts
For Grid-No.2 voltages between 165 and 330 volts	—	See curve page 300

Triode Unit	Pentode Unit	
300	330	volts
—	330	volts
—	See curve page 300	
0	0	volts
1	5	watts
—	1.5	watts
—	See curve page 300	

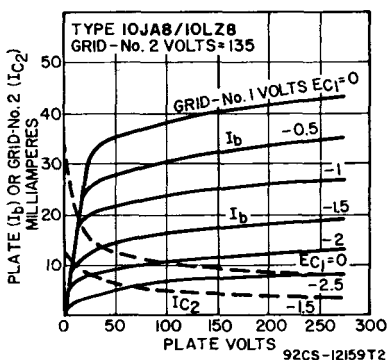
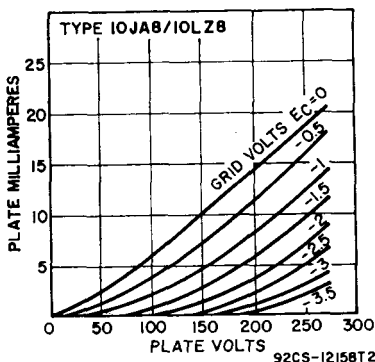

CHARACTERISTICS

	Triode Unit		Pentode Unit			
Plate Voltage	135	200	30	135	200	volts
Grid-No.2 Voltage	—	—	135	135	135	volts
Grid-No.1 Voltage	-2	-2	0	-1.5	-1.5	volts
Amplification Factor	60	70	—	—	—	
Plate Resistance	39000	19000	—	66000	70000	ohms
Transconductance	1550	3700	—	12600	14000	μmhos

Plate Current	1	3.5	32*	17	18	mA
Grid-No.2 Current	—	—	14*	4.2	4	mA
Grid-No.1 Voltage (Approx.) for plate current of 10 μ A	-4.3	-7	—	-5	-5	volts

MAXIMUM CIRCUIT VALUES

Grid-No.1-Circuit Resistance:		Triode Unit	Pentode Unit	
For fixed-bias operation		0.5	0.25	megohm
For cathode-bias operation		1	1	megohm

* This value can be measured by a method involving a recurrent waveform such that the maximum ratings of the tube will not be exceeded.

Refer to type 6JT8.

10JT8

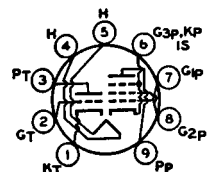

9DX

100 average (-300 peak, -200 average for triode unit).

**MEDIUM-MU TRIODE—
SHARP-CUTOFF PENTODE**

10JY8

Miniature type used in television receiver applications. The pentode unit is used as a video amplifier, and the triode unit as a sync separator. Outlines section, 6E; requires miniature 9-contact socket. Heater: volts (ac/dc), 10.5; amperes, 0.45; warm-up time (average), 11 seconds; maximum heater-cathode volts, \pm 200 peak,

Class A₁ Amplifier

MAXIMUM RATINGS (Design-Maximum Values)

Plate Voltage	330	330	volts
Grid-No.2 (Screen-Grid) Supply Voltage	—	330	volts
Grid-No.2 Voltage	—	See curve page 300	
Grid-No.1 (Control-Grid) Voltage, Positive-bias value	0	0	volts
Plate Dissipation	2	5	watts
Grid-No.2 Input:			
For Grid-No.2 voltages up to 165 volts	—	1.1	watts
For Grid-No.2 voltages between 165 and 330 volts	—	See curve page 300	

CHARACTERISTICS

Plate Voltage	125	50	200	volts
Grid-No.2 Voltage	—	150	150	volts
Grid-No.1 Voltage	—	0	—	volts
Cathode-Bias Resistor	68	—	100	ohms
Amplification Factor	46	—	—	
Plate Resistance (Approx.)	4400	—	55000	ohms
Transconductance	10400	—	11000	μ mhos
Plate Current	15	60*	24	mA
Grid-No.2 Current	—	18*	4.8	mA
Grid Voltage (Approx.) for plate current of 10 μ A ..	-8	—	-10	volts

MAXIMUM CIRCUIT VALUES

Grid-No.1-Circuit Resistance:		Triode Unit	Pentode Unit	
For fixed-bias operation		0.5	0.25	megohm
For cathode-bias operation		1	1	megohm

* This value can be measured by a method involving a recurrent waveform such that the maximum ratings of the tube will not be exceeded.

Refer to type 6KR8.

10KR8

Refer to type 6KU8.

10KU8

Refer to chart at end of section.

10LB8

Refer to type 6LE8.

10LE8

Refer to chart at end of section.

10LW8

Refer to type 6LY8.

10LY8

Refer to chart at end of section.
For replacement use type 10JA8/10LZ8.

10LZ8

Refer to type 6T10.

10T10

10Z10

Refer to type 6Z10.

11

Refer to chart at end of section.

11AF9

Refer to type 6AF9.

11AR11

Refer to type 6AR11.

11BM8**HIGH-MU TRIODE—
POWER PENTODE**

Miniature type used as vertical deflection oscillator or af amplifier and vertical deflection amplifier or af power amplifier in television receivers. Outlines section, 6G; requires miniature 9-contact socket. This type is identical with type 16A8/PCL82 except for the following items:

Heater Voltage	10.7	volts
Heater Current	0.45	mA

11BQ11

Refer to type 8BQ11.

11BT11**DUAL TRIODE—
SHARP-CUTOFF PENTODE**

Duodecar type used in television receiver applications. The triode units are used for general-purpose applications; the pentode unit is used in video-amplifier service. Outlines section, 8B; requires duodecar 12-contact socket. Heater: volts (ac/dc), 10.7; amperes, 0.6; warm-up time (average), 11 seconds; maximum heater-cathode volts, ± 200 peak, 100 average.

Class A₁ Amplifier**MAXIMUM RATINGS (Design-Maximum Values)**

	Triode Unit No. 1	Triode Unit No. 2	Pentode Unit	
Plate Voltage	330	330	165	volts
Grid-No.2 (Screen-Grid) Voltage ..	—	—	165	volts
Grid-No.1 (Control-Grid) Voltage, Positive-bias value	0	0	0	volts
Plate Dissipation	1.5	2	3.5	watts
Grid-No.2 Input	—	—	1.5	watts

CHARACTERISTICS

Plate Voltage	200	200	35	150	volts
Grid-No.2 Voltage	—	—	100	100	volts
Grid-No.1 Voltage	—	—	0	—	volts
Cathode-Bias Resistor	270	470	—	82	ohms
Amplification Factor	69	40	—	—	—
Plate Resistance (Approx.)	12500	7600	—	51000	ohms
Transconductance	5500	5300	—	19000	μ mhos
Plate Current	7.1	7.2	54	17.4	mA
Grid-No.2 Current	—	—	13.5	3.2	mA
Grid-No.1 Voltage (Approx.) for plate current of 100 μ A	—	—8	—	—6.6	volts
Grid-No.1 Voltage (Approx.) for plate current of 50 μ A	—5.5	—	—	—	volts

MAXIMUM CIRCUIT VALUES

	Triode Unit No. 1	Triode Unit No. 2	Pentode Unit	
Grid-No.1-Circuit Resistance:				
For fixed-bias operation	0.5	0.5	0.05	megohm
For cathode-bias operation	1	1	0.1	megohm

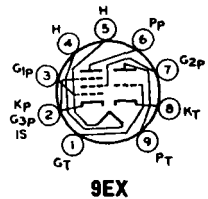
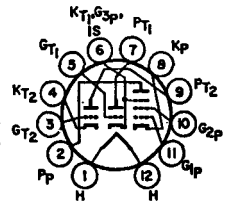
**9EX****12GS**

- Refer to chart at end of section. **11CA11**
- Refer to chart at end of section. **11CF11**
- Refer to chart at end of section. **11CH11**
- Refer to chart at end of section. **11CY7**
- Refer to type 6DS5. **11DS5**
- Refer to type 6FY7. **11FY7**

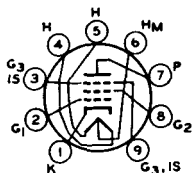

9BF

SHARP-CUTOFF PENTODE

11HM7

Miniature type with frame grid used as video output amplifier in color television receivers. Outlines section, 6E; requires miniature 9-contact socket.

Heater Arrangement	Series	Parallel	
Heater Voltage (ac/dc)	11	5.5	volts
Heater Current	0.3	0.6	ampere
Heater-Cathode Voltage:			
Peak value		±200 max	volts
Average value		100 max	volts
Direct Interelectrode Capacitances:			
Grid No.1 to Plate		0.15 max	pF
Grid No.1 to Cathode, Heater, Grid No.2, Grid No.3, and Internal Shield		14	pF
Plate to Cathode, Heater, Grid No.2, Grid No.3, and Internal Shield		5	pF

Class A₁ Amplifier

MAXIMUM RATINGS (Design-Maximum Values)

Plate Voltage	330	volts
Grid-No.2 (Screen-Grid) Supply Voltage	330	volts
Grid-No.2 Voltage	See curve page 300	
Grid-No.1 (Control-Grid) Voltage, Positive-bias value	0	volts
Plate Dissipation	7	watts
Grid-No.2 Input:		
For grid-No.2 voltages up to 165 volts	1	watt
For grid-No.2 voltages between 165 and 330 volts	See curve page 300	

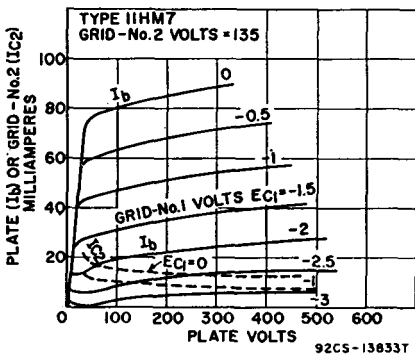

CHARACTERISTICS

Plate Supply Voltage	200	volts
Grid-No.3 Voltage	0	volts
Grid-No.2 Voltage	135	volts
Cathode-Bias Resistor	47	ohms

92CS-13633T

Plate Resistance (Approx.)	40000	ohms
Transconductance	30000	μ mhos
Plate Current	30	mA
Grid-No.2 Current	5.2	mA
Grid-No.1 Voltage (Approx.) for plate current of 100 μ A	-4.5	volts

MAXIMUM CIRCUIT VALUES

Grid-No.1-Circuit Resistance:		
For fixed-bias operation	0.1	megohm
For cathode-bias operation	0.25	megohm

11JE8	Refer to chart at end of section.
11KV8	Refer to type 6KV8.
11LQ8	Refer to type 6LQ8.
11LT8	Refer to type 6LT8.

11MS8**HIGH-MU TRIODE—
BEAM POWER TUBE**

Miniature type used in combined vertical-deflection-oscillator and vertical-deflection-amplifier applications in black-and-white television receivers. **Outlines section, 6G**; requires miniature 9-contact socket. **Heater: volts, 11.6; ampere, 0.45; warm-up time (approx.), 11 seconds; maximum heater-cathode volts, ± 200 peak, 100 average.**

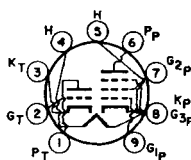
**9LY****Class A₁ Amplifier**

CHARACTERISTICS	Triode Unit		Beam Power Unit	
	Plate Voltage	100	100	120
Grid-No. 1 (Control-Grid) Voltage	—	—	110	volts
Grid-No. 1 (Control-Grid) Voltage	-0.85	0	-10	volts
Plate Current	5	10	50	mA
Grid-No. 2 Current	—	—	3	mA
Transconductance	5500	7000	8500	μ mhos
Amplification Factor*	60	63	5.8	
Plate Resistance (Approx.)	11	9	13	kilohms

Vertical-Deflection Oscillator and Amplifier

For operation in a 525-line, 30-frame system

MAXIMUM RATINGS (Design-Maximum Values)

Plate Voltage	250	250	volts
Peak Positive Pulse Plate Voltage#	—	2000	volts
Grid-No. 2 Voltage	—	200	volts
Grid-No. 1 Voltage	—	0	volts
Plate Dissipation	0.5	6	watts
Grid-No. 2 Input	—	1.5	watts
Average Cathode Current	15	70	mA

MAXIMUM CIRCUIT VALUES

Grid-No. 1 Circuit Resistance	—	2	megohm
Grid-No. 1 Circuit Resistance:			
For fixed-bias operation	1	—	megohm
For cathode-bias operation	3.3	—	megohms

Pulse duration must not exceed 15% of a vertical scanning cycle (2.5 milliseconds).

* Grid-No. 2 connected to plate at socket.

11Y9	Refer to chart at end of section.
11Y9/LFL200	Refer to chart at end of section.
12A5	Refer to chart at end of section.
12A6	Refer to chart at end of section.

Refer to chart at end of section.

12A6Y

Refer to chart at end of section.

12A7

Refer to chart at end of section.

12A8GT

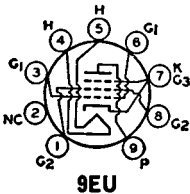

BEAM POWER TUBE

12AB5

Miniature type used in the output stage of automobile radio receivers operating from a 12-volt storage battery. Outlines section, 6E; requires miniature 9-contact socket.

Heater-Voltage Range (ac/dc)	10 to 15.9	volts
Heater Current (Approx.) at 12.6 volts	0.2	ampere
Peak Heater-Cathode Voltage	±90 max	volts

Direct Interelectrode Capacitances:

Grid No.1 to Plate	0.7 max	pF
Grid No.1 to Heater, Grid No.2, and Grid No.3	8	pF
Plate to Cathode, Heater, Grid No.2, and Grid No.3	8.5	pF

• For longest life, it is recommended that the heater be operated within the voltage range of 11 to 14 volts.

Class A₁ Amplifier

MAXIMUM RATINGS (Design-Center Values)

Plate Voltage	315	volts
Grid-No.2 (Screen-Grid) Voltage	285	volts
Plate Dissipation	12	watts
Grid-No.2 Input	2	watts
Bulb Temperature (At hottest point)	250	°C

TYPICAL OPERATION WITH 12.6 VOLTS ON HEATER

Plate Supply Voltage	250	250	volts
Grid-No.2 Supply Voltage	200	250	volts
Grid-No.1 (Control-Grid) Voltage	—	—12.5	volts
Cathode-Bias Resistor	270	—	ohms
Peak AF Grid-No.1 Voltage	10.5	12.5	volts
Zero-Signal Plate Current	33.5	45	mA
Maximum-Signal Plate Current	36	47	mA
Zero-Signal Grid-No.2 Current	1.6	4.5	mA
Maximum-Signal Grid-No.2 Current	3.2	7	mA
Plate Resistance (Approx.)	75000	50000	ohms
Transconductance	4000	4100	μmhos
Load Resistance	6000	5000	ohms
Total Harmonic Distortion	8	8	per cent
Maximum-Signal Power Output	3.3	4.5	watts

MAXIMUM CIRCUIT VALUES

Grid-No.1-Circuit Resistance:		
For fixed-bias operation	0.1	megohm
For cathode-bias operation	0.5	megohm

Push-Pull Class AB₁ Amplifier

MAXIMUM RATINGS (Same as for Single-Tube Class A₁ Amplifier)

TYPICAL OPERATION WITH 12.6 VOLTS ON HEATER (Values are for two tubes)

Plate Voltage	250	volts
Grid-No.2 Voltage	250	volts
Grid-No.1 Voltage	—15	volts
Peak AF Grid-No.1-to-Grid-No.1 Voltage	30	volts
Zero-Signal Plate Current	70	mA
Maximum-Signal Plate Current	79	mA
Zero-Signal Grid-No.2 Current	5	mA
Maximum-Signal Grid-No.2 Current	13	mA
Effective Load Resistance (Plate-to-Plate)	10000	ohms
Total Harmonic Distortion	5	per cent
Maximum-Signal Power Output	10	watts

MAXIMUM CIRCUIT VALUES

Grid-No.1-Circuit Resistance:		
For fixed-bias operation	0.1	megohm
For cathode-bias operation	0.5	megohm

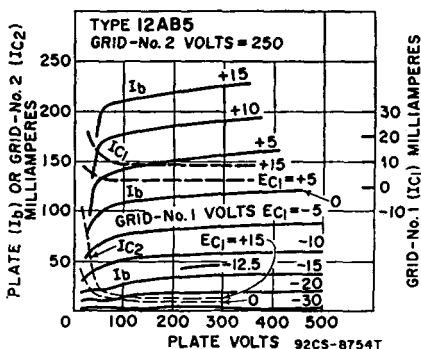
**12AC6**

Refer to chart at end of section.

12AC10A

Refer to type 6AC10

12AD6

Refer to chart at end of section.

12AE6

Refer to chart at end of section.

12AE6A**12AE7**

Refer to chart at end of section.

12AE10**BEAM POWER TUBE—
SHARP-CUTOFF PENTODE**

Duodecarr type used as combined FM detector and audio-frequency output amplifier in television receivers. The beam power unit is used in af output stages and the pentode unit as an FM detector. **Outlines section, 8C;** requires duodecarr 12-contact socket. **Heater:** volts (ac/dc), 12.6; amperes, 0.45; warm-up time (average), 11 seconds; maximum heater-cathode volts, ± 200 peak, 100 average.

**12EZ****Beam Power Unit as Class A, Amplifier****MAXIMUM RATINGS (Design-Maximum Values)**

Plate Voltage	165	volts
Grid-No.2 (Screen-Grid) Voltage	150	volts
Cathode Current	60	mA
Plate Dissipation	6	watts
Grid-No.2 Input	1.25	watts

TYPICAL OPERATION

Plate Voltage	145	volts
Grid-No.2 Voltage	110	volts
Grid-No.1 (Control-Grid) Voltage	-7	volts
Peak AF Grid-No.1 Voltage	7	volts
Zero-Signal Plate Current	34	mA
Maximum-Signal Plate Current	39	mA
Zero-Signal Grid-No.2 Current	6.5	mA
Maximum-Signal Grid-No.2 Current	9.3	mA
Plate Resistance (Approx.)	33000	ohms
Transconductance	5600	μ mhos
Load Resistance	2500	ohms
Total Harmonic Distortion (Approx.)	12	per cent
Maximum-Signal Power Output	1.45	watts

MAXIMUM CIRCUIT VALUE

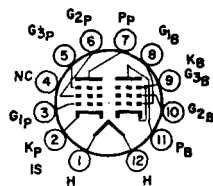
Grid-No.1-Circuit Resistance:		
For cathode-bias operation	1	megohm

Pentode Unit as Class A₁ Amplifier

CHARACTERISTICS

Plate Voltage	150	volts
Grid-No.3 (Suppressor-Grid) Voltage	0	volts
Grid-No.2 Voltage	100	volts
Cathode-Bias Resistor	560	ohms
Plate Resistance (Approx.)	0.15	megohm
Transconductance, Grid No.1	1000	μ mbos
Transconductance, Grid No.3	400	μ mbos
Plate Current	1.3	mA
Grid-No.2 Current	2	mA
Grid-No.1 Voltage (Approx.) for plate current of 10 μ A	-4.5	volts
Grid-No.3 Voltage (Approx.) for plate current of 10 μ A	-4.5	volts

Pentode Unit as FM Detector

MAXIMUM RATINGS (Design-Maximum Values)

Plate Voltage	330	volts
Grid-No.3 Voltage	28	volts
Grid-No.2 Supply Voltage	330	volts
Grid-No.2 Voltage	See curve page 300	
Grid-No.1 Voltage, Positive-bias value	0	volts
Plate Dissipation	1.7	watts
Grid-No.2 Input	1.1	watts

Refer to type 6AF3.

12AF3
12AF3/12BR3/
12RK19

Refer to chart at end of section.

12AF6

Refer to chart at end of section.

12AH7GT

Refer to chart at end of section.

12AJ6

Refer to type 6AL5.

12AL5

Refer to chart at end of section.

12AL8

Refer to type 6AL11.

12AL11

Refer to type 6AQ5A.

12AQ5

Refer to type 6AT6.

12AT6

For replacement use type 12AT7/ECC81.

12AT7

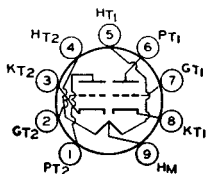

HIGH-MU TWIN TRIODE

12AT7/
ECC81

Miniature types used as push-pull cathode-drive amplifiers or frequency converters in the FM and television broadcast bands. Outlines section, 6B; require miniature 9-contact socket. Each triode unit is independent of the other except for the common heater. For typical operation as a resistance-coupled amplifier, refer to Resistance-Coupled Amplifier section.

Heater Arrangement:	Series	Parallel	
Heater Voltage (ac/dc)	12.6	6.3	volts
Heater Current	0.15	0.3	ampere
Peak Heater-Cathode Voltage		± 90 max	volts

Direct Interelectrode Capacitances:

Grid-Drive Operation:		
Grid to Plate (Each unit)	1.5	pF
Grid to Cathode and Heater (Each unit)	2.2	pF
Plate to Cathode and Heater:		
Unit No.1	0.5	pF
Unit No.2	0.4	pF
Cathode-Drive Operation:		
Cathode to Plate (Each unit)	0.2	pF
Cathode to Grid and Heater (Each unit)	4.6	pF
Plate to Grid and Heater (Each unit)	1.8	pF
Heater to Cathode (Each Unit)	2.4	pF

Class A₁ Amplifier (Each Unit)

MAXIMUM AND MINIMUM RATINGS (Design-Center Values)

Plate Voltage	300	volts
Grid Voltage, Negative-bias value	50	volts
Plate Dissipation	2.5	watts

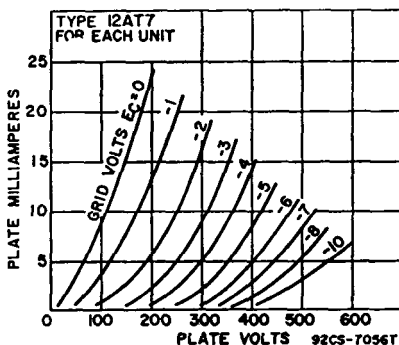

CHARACTERISTICS

Plate Supply Voltage	100	250	volts
Cathode-Bias Resistor	270	200	ohms
Amplification Factor	60	60	
Plate Resistance (Approx.)	15000	10900	ohms
Transconductance	4000	5500	μmhos
Grid Voltage (Approx.) for plate current of 10 μA	-5	-12	volts
Plate Current	3.7	10	mA

12AT7WA

Refer to chart at end of section.

12AT7WB

Refer to chart at end of section.

12AU6

Refer to type 6AU6A.

12AU7

Refer to chart at end of section.

12AU7A

For replacement use type 12AU7A/ECC82.

For replacement use type 12AU7A/ECC82.

12AU7A/
ECC82

7AU7, 9AU7

MEDIUM-MU TWIN TRIODE

Miniature types used as phase inverters or push-pull amplifiers in ac/dc radio equipment and as multivibrators or oscillators in industrial control devices. Also used as combined vertical oscillators and vertical-deflection amplifiers, and as horizontal-deflection oscillators, in color and black-and-white television receivers. Outlines section, 6B; require miniature 9-contact socket. Each triode unit is independent of the other except for the common heater. For typical opera-

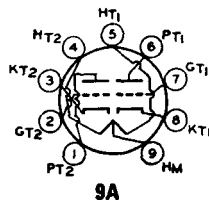

tion as a resistance-coupled amplifier, refer to Resistance-Coupled Amplifier section. Types 7AU7 and 9AU7 are identical with type 12AU7 and 12AU7A/ECC82 except for heater ratings.

	7AU7	9AU7	12AU7A/ 12AU7A/ ECC82	
Heater Voltage(ac/dc):				
Series	7	9.4	12.6	volts
Parallel	3.5	4.7	6.3	volts
Heater Current:				
Series	0.3	0.225	0.15	ampere
Parallel	0.6	0.45	0.3	ampere
Heater Warm-up Time (Parallel, Average) ..	11	11	—	seconds
Heater-Cathode Voltage:				
Peak value	±200 max	±200 max	±200 max	volts
Average value	100 max	100 max	100 max	volts
Direct Interelectrode Capacitances (Approx.):	Unit No.1		Unit No.2	
Grid to Plate	1.5		1.5	pF
Grid to Cathode and Heater	1.6		1.6	pF
Plate to Cathode and Heater	0.5		0.35	pF

Class A₁ Amplifier (Each Unit Unless Otherwise Specified)

MAXIMUM RATINGS (Design-Maximum Values)

Plate Voltage	330	volts
Cathode Current	22	mA
Plate Dissipation:		
Each Plate	2.75	watts
Both Plates (Both units operating)	5.5	watts

CHARACTERISTICS

Plate Voltage	100	250	volts
Grid Voltage	0	-8.5	volts
Amplification Factor	19.5	17	
Plate Resistance (Approx.)	6250	7700	ohms
Transconductance	3100	2200	μmhos
Plate Current	11.8	10.5	mA
Grid Voltage (Approx.) for plate current of 10 μA	—	-24	volts

MAXIMUM CIRCUIT VALUES

Grid-Circuit Resistance:		
For fixed-bias operation	0.25	megohm
For cathode-bias operation	1	megohm

Oscillator (Each Unit Unless Otherwise Specified)

For operation in a 525-line, 30-frame system

MAXIMUM RATINGS (Design-Maximum Values)	Vertical-Deflection Oscillator	Horizontal-Deflection Oscillator	
DC Plate Voltage	330	330	volts
Peak Negative-Pulse Grid Voltage	440	660	volts
Peak Cathode Current	66	330	mA
Average Cathode Current	22	22	mA
Plate Dissipation:			
Each Plate	2.75	2.75	watts
Both Plates (Both units operating)	5.5	5.5	watts

MAXIMUM CIRCUIT VALUES

Grid-Circuit Resistance	2.2	2.2	megohms
-------------------------------	-----	-----	---------

Vertical-Deflection Amplifier (Each Unit Unless Otherwise Specified)

For operation in a 525-line, 30-frame system

MAXIMUM RATINGS (Design-Maximum Values)

DC Plate Voltage	330	volts
Peak Positive-Pulse Plate Voltage#	1200	volts
Peak Negative-Pulse Grid Voltage	275	volts
Peak Cathode Current	66	mA
Average Cathode Current	22	mA
Plate Dissipation:		
Each Plate	275	volts
Both Plates (Both units operating)	5.5	watts

MAXIMUM CIRCUIT VALUE

Grid-Circuit Resistance, for cathode-bias operation	2.2	megohms
-----------------------------------------------------------	-----	---------

Pulse duration must not exceed 15% of a vertical scanning cycle (2.5 milliseconds).

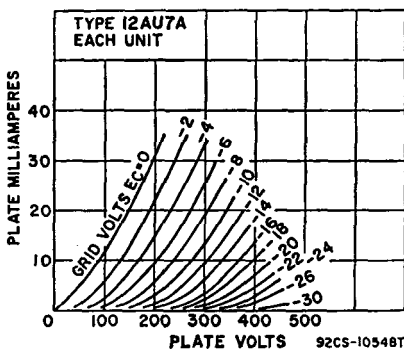
**12AV5GA**

Refer to type 6AV5GA.

12AV6

Refer to type 6AV6.

12AV7

Refer to chart at end of section.

12AW6

Refer to chart at end of section.

12AX3

Refer to type 6AX3.

12AX4GT

Refer to chart at end of section.

12AX4GTA**12AX4GTB**

Refer to type 6AX4GTB.

12AX7Refer to chart at end of section.
For replacement use type 12AX7A/ECC83.**12AX7A**

For replacement use type 12AX7A/ECC83.

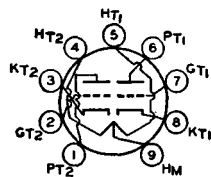
**12AX7A/
ECC83****HIGH-MU TWIN TRIODE****9A**

Miniature types used as phase inverters or twin resistance-coupled amplifiers in radio equipment. Outlines section, 6B; require miniature 9-contact socket. Each triode unit is independent of the other except for common heater. For characteristics and curves, refer to type 6AV6. For typical operation as a resistance-coupled amplifier, refer to Resistance-Coupled Amplifier section.

Heater Arrangement:	Series	Parallel	
Heater Voltage (ac/dc)	12.6	6.3	volts
Heater Current	0.15	0.3	ampere
Heater-Cathode-Voltage:			
Peak value		±200 max	volts
Average value		100 max	volts
Direct Interelectrode Capacitances (Approx.):	Unit No.1	Unit No.2	
Grid to Plate	1.7		pF
Grid to Cathode and Heater	1.6	1.6	pF
Plate to Cathode and Heater	0.46	0.34	pF

Class A₁ Amplifier (Each Unit)

MAXIMUM RATINGS (Design-Maximum Values)

Plate Voltage	330	volts
Grid Voltage:		
Negative-bias value	55	volts
Positive-bias value	0	volts
Plate Dissipation	1.2	watts

EQUIVALENT-NOISE AND HUM VOLTAGE (References To Grid, Each Unit)*

Average Value	1.8	μ V rms
---------------------	-----	-------------

* Measured in "true rms" units under the following conditions: Heater voltage (parallel connection), 6.3 volts ac; center tap of heater transformer grounded; plate supply voltage, 250 volts dc; plate load resistor, 100000 ohms; cathode resistor, 2700 ohms bypassed by 100- μ F capacitor; grid resistor, 0 ohms; and amplifier covering frequency range between 25 and 10000 Hz.

Refer to chart at end of section.

12AY3

Refer to type 6AY3B.

12AY3A

MEDIUM-MU TWIN TRIODE

12AY7

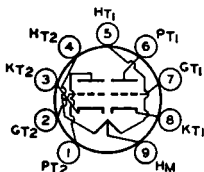

9A

Miniature type used in the first stages of high-gain audio-frequency amplifiers. Outlines section, 6B; requires miniature 9-contact socket. Each triode unit is independent of the other except for the common heater. Use of the 12.6-volt connection with an ac heater supply is not recommended for applications involving low hum. For typical operation as a resistance-coupled amplifier, refer to Resistance-Coupled Amplifier section.

Heater Arrangement:	Series	Parallel	
Heater Voltage (ac/dc)	12.6	6.3	volts
Heater Current	0.15	0.3	ampere
Peak Heater-Cathode Voltage		± 90 max	volts
Direct Interelectrode Capacitances (Approx., Each Unit)			
Grid to Plate		1.3	pF
Grid to Cathode and Heater		1.3	pF
Plate to Cathode and Heater		0.6	pF

Class A₁ Amplifier (Each Unit)

MAXIMUM RATINGS (Design-Center Values)

Plate Voltage	300	volts
Grid Voltage:		
Negative-bias value	50	volts
Positive-bias value	0	volts
Cathode Current	10	mA
Plate Dissipation	1.5	watts

CHARACTERISTICS

Plate Voltage	250	volts
Grid Voltage	-4	volts
Amplification Factor	40	
Plate Resistance	22800	ohms
Transconductance	1750	μ mhos
Plate Current	3	mA
Grid Voltage (Approx.) for plate current of 10 mA	-11	volts

Refer to chart at end of section.

12AZ7

HIGH-MU TWIN TRIODE

12AZ7A

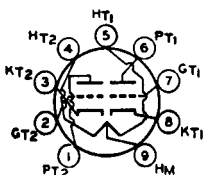

9A

Miniature type used in direct-coupled cathode-drive rf amplifier circuits of vhf color and black-and-white television tuners. Outlines section, 6B; requires miniature 9-contact socket. For characteristics as class A₁ amplifier, refer to miniature type 12AT7.

Heater Voltage (ac/dc):		
Series	12.6	volts
Parallel	6.3	volts
Heater Current:		
Series	0.225	ampere
Parallel	0.45	ampere
Heater Warm-up Time (Average)	11	seconds
Heater-Cathode Voltage:		
Peak value	±200 max	volts
Average value	100 max	volts
Direct Interelectrode Capacitance (Approx.):		
	Unshielded	Shielded ^A
Grid to Plate (Each unit)	2	1.9
Grid to Cathode and Heater (Each unit)	2.6	2.8
Plate to Cathode and Heater:		
Unit No.1	0.44	1.4
Unit No.2	0.36	1.6

^A With external shield connected to cathode of unit under test.

Class A₁ Amplifier (Each Unit)

MAXIMUM RATINGS (Design-Maximum Values)		
Plate Voltage	330	volts
Grid Voltage, Negative-bias value	55	volts
Plate Dissipation	2.5	watts

MAXIMUM CIRCUIT VALUES (Each Unit)		
Grid-Circuit Resistance:		
For fixed-bias operation	0.25	megohm
For cathode-bias operation	1	megohm

12B4A

LOW-MU TRIODE

Miniature type used as vertical-deflection amplifier in television receivers. Outlines section, 6E; requires miniature 9-contact socket.

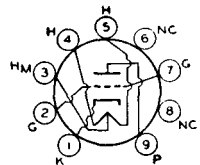

9AG

	Series	Parallel	
Heater Voltage	12.6	6.3	volts
Heater Current	0.3	0.6	ampere
Heater Warm-up Time	—	11	seconds
Heater-Cathode Voltage:			
Peak value		±200 max	volts
Average value		100 max	volts
Direct Interelectrode Capacitances:			
Grid to Plate		4.8	pF
Grid to Cathode and Heater		5	pF
Plate to Cathode and Heater		1.5	pF

Class A₁ Amplifier

MAXIMUM RATINGS (Design-Center Values)		
Plate Voltage	550	volts
Grid Voltage, Negative-bias value	50	volts
Plate Dissipation	5.5	watts

CHARACTERISTICS		
Plate Voltage	150	volts
Grid Voltage	-17.5	volts
Amplification Factor	6.5	
Plate Resistance (Approx.)	1030	ohms
Transconductance	6300	μmhos
Plate Current	34	mA
Plate Current for grid voltage of -23 volts	9.6	mA
Grid Voltage (Approx.) for plate current of 200 μA	-32	volts

MAXIMUM CIRCUIT VALUES		
Grid-Circuit Resistance:		
For fixed-bias operation	0.47	megohm
For cathode-bias operation	2.2	megohms

Vertical-Deflection Amplifier

For operation in a 525-line, 30-frame system

MAXIMUM RATINGS (Design-Center Values)		
DC Plate Voltage	550	volts
Peak Positive-Pulse Plate Voltage* (Absolute Maximum)	1000†	volts

Peak Negative-Pulse Grid Voltage	250	volts
Peak Cathode Current	105	mA
Average Cathode Current	30	mA
Plate Dissipation	5.5	watts

MAXIMUM CIRCUIT VALUE

Grid-Circuit Resistance, for cathode-bias operation	2.2	megohms
-----------------------------------------------------------	-----	---------

Pulse duration must not exceed 15% of a vertical scanning cycle (2.5 milliseconds).

† Under no circumstances should this absolute value be exceeded.

Refer to chart at end of section.	12B8GT
Refer to type 6BA6.	12BA6
Refer to chart at end of section.	12BA7
Refer to chart at end of section.	12BD6
Refer to type 6BE3.	12BE3
Refer to type 6BE6.	12BE6
Refer to chart at end of section.	12BF6
Refer to type 6BF11.	12BF11
Refer to chart at end of section.	12BH7

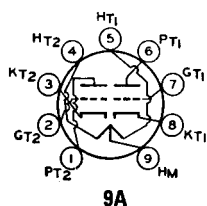

9A

MEDIUM-MU TWIN TRIODE

12BH7A

Miniature type used as combined vertical-deflection amplifier and vertical oscillator, and as horizontal-deflection oscillator, in television receivers, and in phase-inverter and multivibrator circuits. Outlines section, 6E; requires miniature 9-contact socket. Each triode unit is independent of the other except for the common heater.

Heater Arrangement:	Series	Parallel	
Heater Voltage (ac/dc)	12.6	6.3	volts
Heater Current	0.3	0.6	ampere
Heater Warm-up Time (Average)	—	11	seconds
Heater-Cathode Voltage:			
Peak value		±200 max	volts
Average value		100 max	volts
Direct Interelectrode Capacitances (Approx.):	Unit No.1	Unit No.2	
Grid to Plate	2.6	2.6	pF
Grid to Cathode and Heater	3.2	3.2	pF
Plate to Cathode and Heater	0.5	0.4	pF
Plate of Unit No.1 to Plate of Unit No.2		0.8	pF

Class A₁ Amplifier (Each Unit)

MAXIMUM RATINGS (Design-Center Values)		
Plate Voltage	300	volts
Grid Voltage:		
Negative-bias value	50	volts
Positive-bias value	0	volts
Cathode Current	20	mA
Plate Dissipation:		
Each Plate	3.5	watts
Both plates (Both units operating)	7	watts

CHARACTERISTICS

Plate Voltage	250	volts
Grid Voltage	—10.5	volts
Amplification Factor	16.5	
Plate Resistance (Approx.)	5300	ohms
Transconductance	3100	μmhos
Plate Current	11.5	mA
Plate Current for grid voltage of —14 volts	4	mA
Grid Voltage (Approx.) for plate current of 50 μA	—23	volts

MAXIMUM CIRCUIT VALUES

Grid-Circuit Resistance:

For fixed-bias operation	0.25	megohm
For cathode-bias operation	1	megohm

Oscillator (Each Unit)

For operation in a 525-line, 30-frame system

MAXIMUM RATINGS (Design-Center Values)	Vertical-Deflection Oscillator	Horizontal-Deflection Oscillator	
DC Plate Voltage	450	450	volts
Peak Positive-Pulse Grid Voltage	400	600	volts
Peak Cathode Current	70	300	mA
Average Cathode Current	20	20	mA
Plate Dissipation:			
Each Plate	3.5	3.5	watts
Both Plates (Both units operating)	7	7	watts
MAXIMUM CIRCUIT VALUES			
Grid-Circuit Resistance	2.2	2.2	megohms

Vertical-Deflection Amplifier (Each Unit)

For operation in a 525-line, 30-frame system

MAXIMUM RATINGS (Design-Center Values)

DC Plate Voltage	450	volts
Peak Positive-Pulse Plate Voltage* (Absolute maximum)	1500*	volts
Peak Negative-Pulse Grid Voltage	250	volts
Peak Cathode Current	70	mA
Average Cathode Current	20	mA
Plate Dissipation:		
Each Plate	3.5	watts
Both Plates (Both units operating)	7	watts

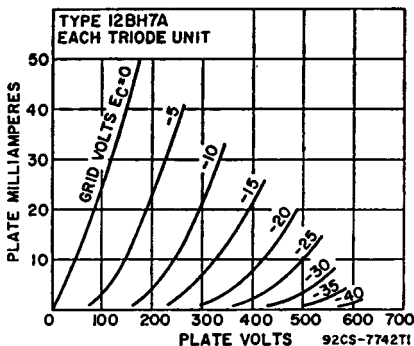
**MAXIMUM CIRCUIT VALUE**

Grid-Circuit Resistance for cathode-bias operation 2.2 megohms

* Pulse duration must not exceed 15% of a vertical scanning cycle (2.5 milliseconds).

* Under no circumstances should this absolute value be exceeded.

12BK5

Refer to chart at end of section.

12BL6

Refer to chart at end of section.

12BN6

Refer to chart at end of section.

12BQ6GTB/12CU6

Refer to type 6BQ6GTB/6CU6.

12BR3

For replacement use type 12AF3/12BR3/12RK19.

12BR7

Refer to chart at end of section.

12BS3

Refer to chart at end of section.

For replacement use type 12BS3A/12DW4A.

For replacement use type 12BS3A/12DW4A.

Refer to type 6BS3A.

Refer to chart at end of section.

Refer to chart at end of section.

For replacement use type 12BY7A/12BV7/12DQ7.

Refer to type 6BV11.

Refer to chart at end of section.

Refer to chart at end of section.

For replacement use type 12BY7A/12BV7/12DQ7.

For replacement use type 12BY7A/12BV7/12DQ7.

12BS3A
12BS3A/12DW4A

12BT3

12BV7

12BV11

12BW4

12BY7

12BY7A

12BY7A/
12BV7/
12DQ7

SHARP-CUTOFF PENTODE

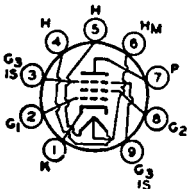

9BF

Miniature types used as video amplifier in television receivers. Outlines section, 6E; require miniature 9-contact socket.

Heater Arrangement:	Series	Parallel	
Heater Voltage (ac/dc)	12.6	6.3	volts
Heater Current	0.3	0.6	ampere
Heater Warm-up Time (Average)	—	11	seconds
Heater-Cathode Voltage:			
Peak value		±200 max	volts
Average value		100 max	volts
Direct Interelectrode Capacitances:			
Grid No.1 to Plate		0.063	pF
Grid No.1 to Cathode, Heater, Grid No.2, Grid No.3, and Internal Shield		10.2	pF
Plate to Cathode, Heater, Grid No.2, and Internal Shield		3.5	pF

Class A₁ Amplifier

MAXIMUM RATINGS (Design-Maximum Values)		
Plate Supply Voltage	330	volts
Grid-No.3 (Suppressor-Grid) Voltage, Positive value	0	volts
Grid-No.2 (Screen-Grid) Voltage	190	volts
Grid-No.1 (Control-Grid) Voltage		
Negative-bias value	55	volts
Positive-bias value	0	volts
Plate Dissipation	6.5	watts
Grid-No.2 Input	1.2	watts

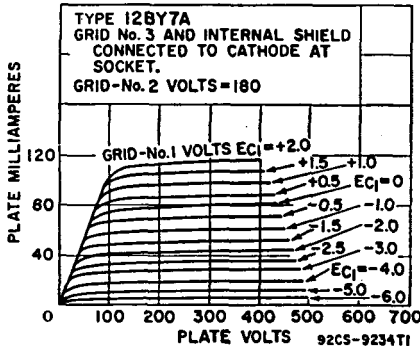

CHARACTERISTICS

Plate Supply Voltage	250	volts
Grid No.3	Connected to cathode at socket	
Grid-No.2 Supply Voltage	180	volts
Cathode-Bias Resistor	100	ohms
Plate Resistance (Approx.)	93000	ohms
Transconductance	11000	μ mhos
Plate Current	26	mA
Grid-No.2 Current	5.75	mA
Grid-No.1 Voltage (Approx.) for plate current of 20 μ A	-11.6	volts

MAXIMUM CIRCUIT VALUES

Grid-No.1-Circuit Resistance:		
For fixed-bias operation	0.25	megohm
For cathode-bias operation	1	megohm

12BZ6	Refer to type 6BZ6.
12BZ7	Refer to chart at end of section.
12C5	Refer to type 6CU5.
12C8	Refer to chart at end of section.
12CA5	Refer to type 6CA5.
12CK3	Refer to chart at end of section.
12CL3	Refer to type 6CL3.
12CN5	Refer to chart at end of section.
12CR6	Refer to chart at end of section.
12CS6	Refer to type 6CS6.

12CT3

17CT3, 25CT3

**HALF-WAVE
VACUUM RECTIFIER**

Miniature type used as damper tube in horizontal-deflection circuits of black-and-white and small-screen color television receivers. Outlines section, 6H; requires miniature 9-contact socket. Socket terminals 1, 3, 7, and 8 should not be used as tie points for external-circuit components. This tube, like other power-handling tubes, should be adequately ventilated. Types 17CT3 and 25CT3 are identical with type 12CT3 except for heater ratings.

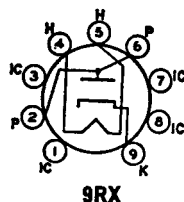

	12CT3	17CT3	25CT3	
Heater Voltage (ac/dc)	6.3	16.8	25.3	volts
Heater Current	0.6	0.45	0.3	amperes
Heater Warm-up Time (Average)	11	11	11	seconds
Direct Interelectrode Capacitances (Approx.):				
Plate to Cathode and Heater			12	pF
Cathode to Plate and Heater			9.5	pF
Heater to Cathode			2.8	pF

Damper Service

For operation in a 525-line, 30-frame system

MAXIMUM RATINGS (Design-Maximum Values)

Peak Inverse Plate Voltage*	5000	volts	
Peak Plate Current	1200	mA	
Average Plate Current	250	mA	
Plate Dissipation	4.75	watts	
Heater-Cathode Voltage:			
Peak value	+300	-5000	volts
Average value	+100	-900	volts
Bulb Temperature (At hottest point)	220	$^{\circ}$ C	

CHARACTERISTICS, Instantaneous Value

Tube Voltage Drop for plate current of 850 mA	16	volts
-----------------------------------------------	----	-------

* Pulse duration must not exceed 15% of a horizontal scanning cycle (10 microseconds).

Refer to chart at end of section.	12CT8
Refer to type 6CU5.	12CU5/12C5
For replacement use type 12BQ6GTB/12CU6.	12CU6
Refer to chart at end of section.	12CX6
Refer to chart at end of section.	12D4
Refer to chart at end of section.	12DB5
Refer to chart at end of section.	12DE8
Refer to type 6DK6.	12DK6
Refer to chart at end of section.	12DK7
Refer to chart at end of section.	12DL8
Refer to chart at end of section.	12DM4
Refer to chart at end of section.	12DM4A
Refer to chart at end of section.	12DQ6A
Refer to chart at end of section.	12DQ6B
For replacement use type 12GW6/12DQ6B.	12DQ6B
Refer to chart at end of section.	12DQ7
For replacement use type 12BY7A/12BV7/12DQ7.	12DQ7
Refer to chart at end of section.	12DS7
Refer to type 6DT5.	12DS7A
Refer to type 6DT8.	12DT5
Refer to chart at end of section.	12DT8
Refer to chart at end of section.	12DU7
Refer to chart at end of section.	12DV8
For replacement use type 12BS3A/12DW4A.	12DW4A
Refer to chart at end of section.	12DW7
Refer to chart at end of section.	12DY8
Refer to chart at end of section.	12DZ6
For replacement use type 12EK6/12DZ6/12EA6.	12EA6
Refer to chart at end of section.	12EA6
For replacement use type 12EK6/12DZ6/12EA6.	12EA6
Refer to chart at end of section.	12EC8
Refer to chart at end of section.	12ED5
Refer to chart at end of section.	12EG6
Refer to chart at end of section.	12EH5
Refer to chart at end of section.	12EK6/12DZ6/12EA6
Refer to chart at end of section.	12EL6
Refer to chart at end of section.	12EM6
Refer to chart at end of section.	12EN6
Refer to chart at end of section.	12EQ7
Refer to chart at end of section.	12F5GT
Refer to chart at end of section.	12F8

12FK6
12FM6
12FQ7
12FQ8
12FR8
12FV7

Refer to chart at end of section.
 Refer to chart at end of section.
 Refer to type 6FQ7/6CG7.
 Refer to chart at end of section.
 Refer to chart at end of section.
 Refer to chart at end of section.

12FX5

19FX5, 60FX5

POWER PENTODE

Miniature type used in output stages of audio amplifiers. Outlines section, 5D; requires miniature 7-contact socket. Types 19FX5 and 60FX5 are identical with type 12FX5 except for heater ratings.

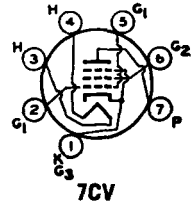

	12FX5	19FX5	60FX5	
Heater Voltage (ac/dc)	12.6	18.9	60	volts
Heater Current	0.45	0.3	2	ampere
Heater Warm-up Time (Average)	11	11	0.1	seconds
Heater-Cathode Voltage:				
Peak value	±200 max	±200 max	±200 max	volts
Average value	100 max	100 max	100 max	volts
Direct Interelectrode Capacitances (Approx.):				
Grid No.1 to Plate			0.65	pF
Grid No.1 to Cathode, Heater, Grid No.2, and Grid No.3			17	pF
Plate to Cathode, Heater, Grid No.2, and Grid No.3			9	pF

Class A₁ Amplifier

MAXIMUM RATINGS (Design-Maximum Values)

Plate Voltage	150	volts
Grid-No.2 (Screen-Grid) Voltage	130	volts
Plate Dissipation	5.5	watts
Grid-No.2 Input	2	watts
Bulb Temperature (At hottest point)	225	°C

TYPICAL OPERATION

Plate Supply Voltage	110	volts
Grid-No.2 Supply Voltage	115	volts
Cathode-Bias Resistor	62	ohms
Peak AF Grid-No.1 Voltage	3	volts
Zero-Signal Plate Current	36	mA
Maximum-Signal Plate Current	35	mA
Zero-Signal Grid No.2 Current	10	mA
Maximum-Signal Grid No.2 Current	12	mA
Plate Resistance	17500	ohms
Transconductance	13500	μmhos
Load Resistance	3000	ohms

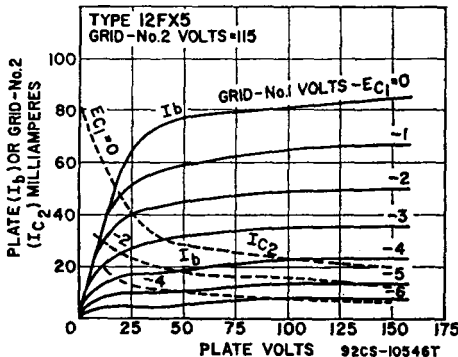

Total Harmonic Distortion	8	per cent
Maximum-Signal Power Output	1.3	watts
MAXIMUM CIRCUIT VALUES		
Grid-No.1-Circuit Resistance:		
For fixed-bias operation	0.1	megohm
For cathode-bias operation	0.5	megohm

Refer to chart at end of section.	12FX8 12FX8A
Refer to chart at end of section.	12GA6
For replacement use type 12BQ6GTB/12CU6.	12GB3
For replacement use type 12GW6/12DQ6B.	12GB6 12GB7
Refer to chart at end of section.	12GC6
Refer to type 6GE5.	12GE5
Refer to chart at end of section.	12GJ5
Refer to type 6GJ5A.	12GJ5A
Refer to chart at end of section.	12GN7
Refer to chart at end of section.	12GN7A
For replacement use type 12HG7/12GN7A.	
Refer to chart at end of section.	12GT5 12GT5A
Refer to type 6GW6/6DQ6B.	12GW6/12DQ6B
Refer to chart at end of section.	12H6
Refer to type 38HE7.	12HE7
For replacement use type 12HG7/12GN7A.	12HG7

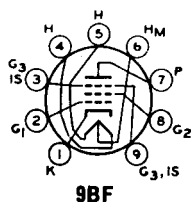

SHARP-CUTOFF PENTODE

**12HG7/
12GN7A**

Miniature types with frame grid used as video amplifier in color and black-and-white television receivers. Outlines section, 6E; require 9-contact miniature socket.

Heater Arrangement:	Series	Parallel	
Heater Voltage (ac/dc)	12.6	6.3	volts
Heater Current	0.26	0.52	ampere

Heater-Cathode Voltage:

Peak value	±200 max	volts
Average value	100 max	volts
Direct Interelectrode Capacitances:		
Grid No.1 to Plate	0.15 max	pF
Grid No.1 to Cathode, Heater, Grid No.2, Grid No.3, and Internal Shield	14 max	pF
Plate to Cathode, Heater, Grid No.2, Grid No.3, and Internal Shield	4.4 max	pF

Class A₁ Amplifier

MAXIMUM RATINGS (Design-Maximum Values)

Plate Voltage	400	volts
Grid-No.2 (Screen-Grid) Supply Voltage	330	volts
Grid-No.2 Voltage	See curve page 300	
Grid-No.1 (Control-Grid) Voltage, Positive-bias value	0	volts
Plate Dissipation	10	watts
Grid-No.2 Input:		
For Grid-No.2 voltages up to 165 volts	1	watt
For Grid-No.2 voltages between 165 and 330 volts	See curve page 300	

CHARACTERISTICS

Plate Supply Voltage	300	volts
Grid No.3 (Suppressor Grid)	Connected to cathode at socket	
Grid-No.2 Supply Voltage	135	volts
Grid No.1	Connected to negative end of cathode resistor	
Cathode Resistor	47	ohms
Plate Resistance (Approx.)	60000	ohms
Transconductance	32000	μmhos
Plate Current	31	mA
Grid-No.2 Current	4.8	mA
Grid-No.1 Voltage (Approx.) for plate current of 100 μA	-4.5	volts

MAXIMUM CIRCUIT VALUES

Grid-No.1-Circuit Resistance:		
For fixed-bias operation	0.1	megohm
For cathode-bias operation	0.25	megohm

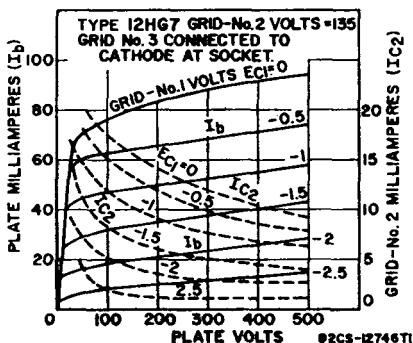

12HL7

SHARP-CUTOFF PENTODE

Miniature type with frame grid used as a video output amplifier in color television receivers. Outlines section, 6E; requires miniature 9-contact socket.

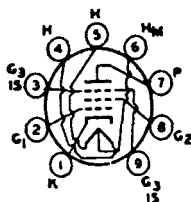

Heater Arrangement	Series	Parallel	
Heater Voltage	12.6	6.3	volts
Heater Current	0.3	0.6	ampere

Heater-Cathode Voltage:			
Peak value	±200 max	±200 max	volts
Average value	100 max	100 max	volts
Direct Interelectrode Capacitances:			
Grid No.1 to Plate		0.15	pF
Grid No.1 to Cathode, Heater, Grid No.2, Grid No.3, and Internal Shield		15	pF
Plate to Cathode, Heater, Grid No.2, Grid No.3, and Internal Shield		6	pF

Class A₁ Amplifier

MAXIMUM RATINGS (Design-Maximum Values)

Plate Voltage		400	volts
Grid-No.3 (Suppressor-Grid) Voltage, Positive-bias value		0	volts
Grid-No.2 (Screen-Grid) Supply Voltage		330	volts
Grid-No.2 Voltage		See curve page 300	
Grid-No.1 (Control-Grid) Voltage, Positive-bias value		0	volt
Plate Dissipation		10	watts
Grid-No.2 Input		1	watt

CHARACTERISTICS

Plate Supply Voltage	50	250	volts
Grid-No.3 Voltage, Referred to negative end of cathode	—	0	volts
Grid-No.2 Voltage	125	160	volts
Grid-No.1 Voltage	0	0	volts
Cathode Resistor (Bypassed)	—	122	ohms
Plate Current	76	25	mA
Grid-No.2 Current	32	6	mA
Transconductance, Grid No.1 to Plate	—	21000	μmhos
Plate Resistance (Approx.)	—	55000	ohms
Grid-No.1 Voltage (Approx.) for plate current of 100 μA	—	-7.2	volts

MAXIMUM CIRCUIT VALUES

Grid-No.1-Circuit Resistance:			
For fixed-bias operation		0.1	megohm
For cathode-bias operation		0.25	megohm

Refer to chart at end of section.	12J5GT
Refer to chart at end of section.	12J7GT
Refer to chart at end of section.	12J8
Refer to chart at end of section.	12JB6
Refer to type 6JB6A.	12JB6A
Refer to chart at end of section.	12JF5
Refer to type 6JN6.	12JN6
Refer to chart at end of section.	12JN8
Refer to type 6JQ6.	12JQ6
Refer to chart at end of section.	12JT6
Refer to type 6JT6A.	12JT6A
Refer to chart at end of section.	12K5
Refer to chart at end of section.	12K7GT
Refer to chart at end of section.	12K8
Refer to chart at end of section.	12KL8
Refer to chart at end of section.	12L6GT
Refer to type 6MD8.	12MD8
Refer to chart at end of section.	12Q7GT
Refer to chart at end of section.	12R5

12RK19	Refer to chart at end of section. For replacement use type 12AF3/12BR3/12RK19.
12S8GT	Refer to chart at end of section.
12SA7	Refer to chart at end of section.
12SA7GT	Refer to chart at end of section.
12SC7	Refer to chart at end of section.
12SF5	Refer to chart at end of section.
12SF5GT	Refer to chart at end of section.
12SF7	Refer to chart at end of section.
12SG7	Refer to chart at end of section.
12SH7	Refer to chart at end of section.
12SJ7	Refer to chart at end of section.
12SJ7GT	Refer to chart at end of section.
12SK7	Refer to chart at end of section.
12SK7GT	Refer to chart at end of section.
12SL7GT	Refer to type 6SL7GT.
12SN7GT	Refer to chart at end of section.
12SN7GTA	Refer to type 6SN7GTB.
12SQ7	Refer to chart at end of section.
12SQ7GT	Refer to chart at end of section.
12SR7	Refer to chart at end of section.
12SR7GT	Refer to chart at end of section.
12SW7	Refer to chart at end of section.
12SY7	Refer to chart at end of section.
12T10	Refer to type 6T10.
12U7	Refer to chart at end of section.
12V6GT	Refer to type 6V6.
12W6GT	Refer to type 6W6GT.
12X4	Refer to type 6X4.
12Z3	Refer to chart at end of section.
13CW4	Refer to type 6CW4.
13DE7	Refer to type 6DE7.
13DR7	Refer to type 6DR7.
13EM7	Refer to chart at end of section. For replacement use type 13EM7/15EA7.
13EM7/15EA7	Refer to type 6EM7/6EA7.
13FD7	Refer to type 6FD7.
13FM7	Refer to type 6FM7.
13FM7/15FM7	Refer to type 6FM7.
13GB5	Refer to chart at end of section.
13GB5/XL500	Refer to type 6GB5/EL500.
13GF7A	Refer to type 6GF7A.

Refer to chart at end of section.
For replacement use type 13Z10/13J10.

13J10

Refer to type 6JZ8.

13JZ8

**BEAM POWER TUBE—
SHARP-CUTOFF PENTODE**

13V10

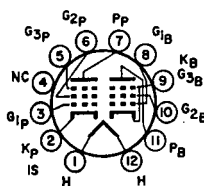

12EZ

Duodecar type used as combined FM detector and audio-frequency output amplifier in television receivers. The beam power unit is used in af output stages and the pentode unit as an FM detector. Outlines section, 8C; requires duodecar 12-contact socket. Heater: volts (ac/dc), 13.2; amperes, 0.45; average warm-up time, 11 seconds; maximum heater-cathode volts, ± 200 peak, 100 average.

Beam Power Unit as Class A₁ Amplifier

MAXIMUM RATINGS (Design-Maximum Values)

Plate Voltage	165	volts
Grid-No.2 (Screen-Grid) Voltage	150	volts
Cathode Current	65	mA
Plate Dissipation	6.5	watts
Grid-No.2 Input	1.8	watts

TYPICAL OPERATION

Plate Voltage	145	volts
Grid-No.2 Voltage	125	volts
Grid-No.1 (Control-Grid) Voltage	-6	volts
Peak AF Grid-No.1 Voltage	6	volts
Zero-Signal Plate Current	34	mA
Maximum-Signal Plate Current	36	mA
Zero-Signal Grid-No.2 Current	2.2	mA
Maximum-Signal Grid-No.2 Current	5.5	mA
Plate Resistance (Approx.)	0.058	megohm
Transconductance	6400	μ mhos
Load Resistance	3000	ohms
Total Harmonic Distortion (Approx.)	7	per cent
Maximum-Signal Power Output	1.5	watts

MAXIMUM CIRCUIT VALUES

Grid-No.1-Circuit Resistance:		
For fixed-bias operation	0.25	megohm
For cathode-bias operation	0.5	megohm

Pentode Unit as Class A₁ Amplifier

CHARACTERISTICS

Plate Supply Voltage	150	volts
Grid-No.3 (Suppressor-Grid) Voltage	0	volts
Grid-No.2 (Screen-Grid) Supply Voltage	100	volts
Cathode-Bias Resistor	560	ohms
Plate Resistance (Approx.)	0.15	megohm
Transconductance, Grid No.1 to Plate	1000	μ mhos
Transconductance, Grid No.3 to Plate	400	μ mhos
Plate Current	1.3	mA
Grid-No.2 Current	2	mA
Grid-No.1 Voltage (Approx.) for plate current of 10 μ A	-4.5	volts
Grid-No.3 Voltage (Approx.) for plate current of 10 μ A	-4.5	volts

Pentode Unit as FM Detector

MAXIMUM RATINGS (Design-Maximum Values)

Plate Voltage	330	volts
Grid-No.3 Voltage	28	volts
Grid-No.2 Supply Voltage	330	volts
Grid-No.2 Voltage	See curve page 300	
Grid-No.1 (Control-Grid) Voltage, Positive-bias value	0	volts
Plate Dissipation	1.7	watts
Grid-No.2 Input:		
For grid-No.2 voltages up to 165 volts	1.1	watts
For grid-No.2 voltages between 165 and 330 volts	See curve page 300	

Refer to chart at end of section.

13Z10

Refer to type 6Z10/6J10.

13Z10/13J10

14A4	Refer to chart at end of section.
14A5	Refer to chart at end of section.
14A7	Refer to chart at end of section.
14AF7	Refer to chart at end of section.
14B6	Refer to chart at end of section.
14B8	Refer to chart at end of section.

14BL11**DUAL TRIODE—
SHARP-CUTOFF PENTODE**

Duodecar type used in television receiver applications. The pentode unit is used for video amplifier service, and the triode units for general-purpose use. Outlines section, 8B; requires duodecar 12-contact socket. Heater: volts (ac/dc), 14.2; amperes, 0.45; average warm-up time 11 seconds; maximum heater-cathode volts, ± 200 peak, 100 average.

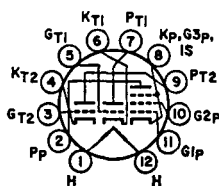
**12GC****Class A₁ Amplifier**

MAXIMUM RATINGS (Design-Maximum Values)	Triode		Pentode		
	Unit No.1	Unit No.2	Unit	Unit	
Plate Voltage	330	330	250		volts
Grid-No.2 (Screen-Grid) Voltage	—	—	125		volts
Grid-No.1 (Control-Grid) Voltage, Positive-bias value	0	0	0		volts
Plate Dissipation	1.5	2	2.5		watts
Grid-No.2 Input	—	—	1.25		watts
CHARACTERISTICS					
Plate Voltage	200	200	35	200	volts
Grid-No.2 Voltage	—	—	100	100	volts
Grid-No.1 Voltage	—	—	0	—	volts
Cathode-Bias Resistor	470	270	—	82	ohms
Amplification Factor	40	69	—	—	
Plate Resistance (Approx.)	7600	12500	—	70000	ohms
Transconductance	5300	5500	—	19000	μ mhos
Plate Current	7.2	7.1	40	16	mA
Grid-No.2 Current	—	—	13	3	mA
Grid-No.1 Voltage (Approx.) for plate current of 100 μ A	-8	-5.5	—	-5.5	volts
MAXIMUM CIRCUIT VALUES					
Grid-No.1-Circuit Resistance:					
For fixed-bias operation	0.5	0.5	0.1		megohm
For cathode-bias operation	1	1	0.25		megohm

14BR11**DUAL TRIODE—
SHARP-CUTOFF PENTODE**

Duodecar type used in television receiver applications. The high- μ triode unit No. 1 is used for general-purpose use, the medium- μ triode unit No. 2 for sync separator service, and the pentode unit for video amplifier service. Outlines section, 8C; requires duodecar 12-contact socket. Heater: volts (ac/dc), 14.2; amperes, 0.45; warm-up time, 11 seconds; maximum heater-cathode volts, ± 200 peak, 100 average.

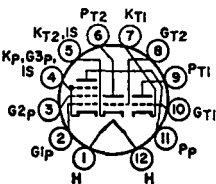
**12GL**

Class A₁ Amplifier

MAXIMUM RATINGS (Design-Maximum Values)

	Triode Unit No.1	Triode Unit No.2	Pentode Unit		
Plate Voltage	330	330	330		volts
Grid-No.2 (Screen-Grid) Supply Voltage	—	—	330		volts
Grid-No.2 Voltage	—	—	See curve page 300		
Grid-No.1 (Control-Grid) Voltage, Positive-bias value	0	0	0		volts
Plate Dissipation	1.5	2	4		watts
Grid-No.2 Input:					
For grid-No.2 voltages up to 165 volts	—	—	1.1		watts
For grid-No.2 voltages between 165 and 330 volts	—	—	See curve page 300		

CHARACTERISTICS

Plate Voltage	200	200	35	135	volts
Grid-No.2 Voltage	—	—	135	135	volts
Grid-No.1 Voltage	-2	—	0	—	volts
Cathode-Bias Resistor	—	220	—	100	ohms
Amplification Factor	68	41	—	—	
Plate-Resistance (Approx.)	12400	9400	—	45000	ohms
Transconductance	5500	4400	—	10400	μmhos
Plate Current	7	9.2	34	17	mA
Grid-No.2 Current	—	—	13	4	mA
Grid-No.1 Voltage (Approx.) for plate current of 100 μA	-5.5	-6.5	—	-6	volts

MAXIMUM CIRCUIT VALUES

Grid-No.1-Circuit Resistance:					
For fixed-bias operation	0.5	0.5	1		megohm
For cathode-bias operation	1	1	1		megohm

Refer to chart at end of section.	14C5
Refer to chart at end of section.	14C7
Refer to chart at end of section.	14E6
Refer to chart at end of section.	14E7
Refer to chart at end of section.	14F7
Refer to chart at end of section.	14F8
Refer to chart at end of section.	14GT8
Refer to chart at end of section.	14H7
Refer to chart at end of section.	14J7
Refer to chart at end of section.	14JG8
Refer to chart at end of section.	14N7
Refer to chart at end of section.	14Q7
Refer to chart at end of section.	14R7
Refer to chart at end of section.	15
Refer to type 6AF11.	15AF11
Refer to chart at end of section.	15BD11
Refer to chart at end of section.	15BD11A
Refer to chart at end of section.	15CW5
Refer to type 6CW5/EL86.	15CW5/PL84
Refer to chart at end of section.	15DQ8

15DQ8/ PCL84

HIGH-MU TRIODE— SHARP-CUTOFF PENTODE

Miniature type used in color and black-and-white television receiver applications. The triode unit is used as a sync-separator, sync-amplifier, keyed-agc, or noise-suppressor tube. The pentode unit is used as a video-output tube. Outlines section, 6E; requires miniature 9-contact socket.

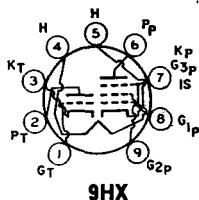

Heater Voltage (ac/dc)	15	volts
Heater Current	0.3	ampere
Peak Heater-Cathode Voltage	±200 max	volts

Class A₁ Amplifier

MAXIMUM RATINGS (Design-Maximum Values)

	Triode Unit	Pentode Unit	
Plate Supply Voltage	550	550	volts
Peak Plate Voltage, with maximum plate current of 0.1 mA*	600	—	volts
Plate Voltage	250	250	volts
Grid-No.2 (Screen-Grid) Supply Voltage	—	550	volts
Grid-No.2 Voltage	—	250	volts
Cathode Current	12	40	mA
Plate Dissipation	1	4	watts
Grid-No.2 Input	—	1.7	watts

CHARACTERISTICS

	Triode Unit	Pentode Unit			
Plate Voltage	200	170	200	200	volts
Grid-No.2 Voltage	—	170	200	220	volts
Grid-No.1 Voltage	-1.7	-2.1	-2.9	-3.4	volts
Amplification Factor	65	—	—	—	
Mu-Factor, Grid-No.2 to Grid-No.1	—	36	36	36	
Plate Resistance (Approx.)	—	0.1	0.13	0.15	megohm
Transconductance	4000	11000	10400	10000	μmhos
Plate Current	3	18	18	18	mA
Grid-No.2 Current	—	3	3	3	mA

TYPICAL OPERATION OF PENTODE UNIT AS VIDEO OUTPUT TUBE

Plate Supply Voltage	170	200	220	volts
Series Plate Resistor	3000	3000	3000	ohms
Grid-No.2 Voltage	170	200	220	volts
Grid-No.1 Voltage	-2	-2.8	-3.3	volts
Transconductance	10400	10000	9700	μmhos
Plate Current	18	18	18	mA
Grid-No.2 Current	3.2	3.1	3.1	mA

MAXIMUM CIRCUIT VALUES

Grid-No.1-Circuit Resistance:	Triode Unit	Pentode Unit	
For fixed-bias operation	1	1	megohm
For cathode-bias operation	3	2	megohms

* With maximum duty factor of 0.18 and maximum pulse duration of 18 microseconds.

15EA7

For replacement use type 13EM7/15EA7.

15EW7

Refer to type 6EW7.

15FM7

Refer to chart at end of section.
For replacement use type 13FM7/15FM7.

15FY7

Refer to type 6FY7.

15HB6

Refer to chart at end of section.

15KY8

Refer to chart at end of section.

15KY8A

Refer to type 6KY8A.

15LE8

Refer to chart at end of section.

Refer to type 6MF8.

15MF8

Refer to chart at end of section.
For replacement use type 16A8/PCL82.

16A8

16A8/ PCL82

8B8

HIGH-MU TRIODE— POWER PENTODE

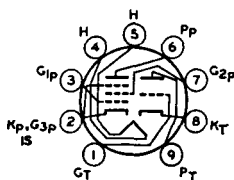

9EX

Miniature type used in television receiver applications. The triode unit is used as a vertical oscillator or as an af amplifier, and the pentode unit is used as a vertical output tube or as an audio output tube. Outlines section, 6G; requires miniature 9-contact socket. Type 8B8 is identical with type 16A8/PCL82 except for heater ratings.

Heater Voltage	8B8	16A8/PCL82	volts
Heater Current	8	16	ampere
Heater-Cathode Voltage	0.6	0.3	volts
	±200	±200	volts

Class A₁ Amplifier

MAXIMUM RATINGS (Design-Maximum Values)	Triode Unit	Pentode Unit	
Plate Supply Voltage	550	550	volts
Peak Plate Voltage*	600	2500	volts
Plate Voltage	250	250	volts
Peak Inverse Plate Voltage	—	500	volts
Grid-No.2 (Screen-Grid) Supply Voltage	—	550	volts
Grid-No.2 Voltage	—	250	volts
Cathode Current	15	50	mA
Plate Dissipation (Frame Output)	—	5	watts
Plate Dissipation (Audio Output)	—	7	watts
Grid-No.2 Input	—	1.8	watts
Peak Grid-No.2 Input	—	3.2	watts

CHARACTERISTICS

	Triode Unit	Pentode Unit				
Plate Voltage	100	100	170	200	200	volts
Grid-No.2 Voltage	—	100	170	200	200	volts
Grid-No.1 Voltage	0	-6	-11.5	-12.5	-16	volts
Amplification Factor	70	—	—	—	—	
Mu Factor, Grid No.2 to Grid No.1	—	10	9.5	9.5	9.5	
Plate Resistance	—	15000	16000	20500	20000	ohms
Transconductance	2500	6800	7500	6800	6400	μmhos
Plate Current	3.5	26	41	35	7	mA
Grid-No.2 Current	—	5	8	6.5	35	mA

MAXIMUM CIRCUIT VALUES

Grid-No.1-Circuit Resistance:			
For fixed-bias operation	1	1	megohm
For cathode-bias operation	3	2	megohms

* With a maximum duty factor of 0.04 and maximum pulse duration of 0.8 milliseconds.

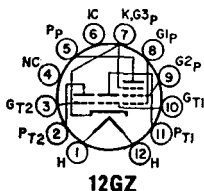

12GZ

DUAL TRIODE— BEAM POWER TUBE

16AK9

Duodecar type used in vertical-deflection-amplifier, vertical oscillator and sync-clipper applications, in color television receivers. Outlines section, 15A; requires duodecar 12-contact socket. Heater: volts (ac/dc), 16.4; amperes, 0.6; average warm-up time, 11 seconds; maximum heater-cathode volts, ±200 peak, 100 average.

Class A₁ Amplifier

CHARACTERISTICS	Triode		Beam Power		
	Unit No. 1	Unit No. 2	Unit		
Plate Voltage	150	150	60	150	volts
Grid-No.2 (Screen-Grid) Voltage	—	—	125	150	volts
Grid-No.1 (Control-Grid) Voltage	—2	—5	0	—14	volts
Plate Resistance (Approx.)	11000	3500	—	18400	ohms
Transconductance	3900	2350	—	6200	μmhos
Plate Current	5.4	5.5	140	49	mA
Grid-No.2 Current	—	—	18	3.5	mA
Grid-No.1 Voltage (Approx.) for plate current of 100 μA	—5.7	—11	—	—33	volts
Amplification Factor	43	20	—	—	

Vertical-Deflection Oscillator and Amplifier

For operation in a 525-line, 30-frame system

MAXIMUM RATINGS (Design-Maximum Values)	Triode		Beam Power		
	Unit No. 1 Amplifier	Unit No. 2 Oscillator	Unit Amplifier		
Plate Voltage	330	330	350		volts
Peak Positive-Pulse Plate Voltage#	—	—	2500		volts
Grid-No.2 Voltage	—	—	250		volts
Peak Negative-Pulse Grid-No.1 Voltage	—	400	150		volts
Grid Voltage, Positive-bias value	0	—	—		volt
Plate Dissipation	1.25	1	10		watts
Grid-No.2 Input	—	—	2		watts
Peak Plate Current	—	70	245		mA
Average Plate Current	—	20	80		mA
Peak Grid-No.2 Current	—	—	245		mA
Average Grid-No.2 Current	—	—	80		mA

MAXIMUM CIRCUIT VALUES

Grid-No.1 Circuit Resistance:					
For fixed-bias operation	0.5	1	1		megohm
For degenerative-bias operation*	—	2.2	2.2		megohms

Pulse duration must not exceed 15% of a horizontal scanning cycle (10 microseconds).

* A cathode resistor or any feedback system which achieves an equivalent reduction in gain.

16AQ3

Refer to chart at end of section.

For replacement use type 16AQ3/XY88.

16AQ3/
XY88

20AQ3/LY88

DIODE

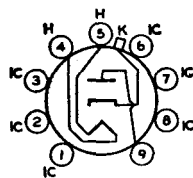

9CB

Miniature type used as booster diodes in line-time-base circuits of transformerless television receivers.

Outlines section, 7D; requires miniature 9-contact socket. Type 20AQ3/LY88 is identical with type 16AQ3/XY88 except for heater ratings.

	16AQ3/ XY88	20AQ3/ LY88	
Heater Voltage (ac/dc)	16.4	20.2	volts
Heater Current	0.6	0.45	ampere
Peak Heater-Cathode Voltage	6600	6600	volts

MAXIMUM RATINGS (Design-Center Values)

Supply Voltage at zero current		550	volts
Supply Voltage		250	volts
Peak Plate Current		550	mA
Average Plate Current		220	mA
Plate Dissipation		5	watts
Peak Negative-Pulse Plate Voltage*		6000#	volts

* Under no conditions should an absolute maximum value of 7500 volts be exceeded.

The pulse duration must not exceed 22 per cent of a cycle, or a maximum of 18 microseconds

16BQ11

Refer to type 8BQ11.

Refer to chart at end of section.	16BX11
Refer to type 6GK6.	16GK6
Refer to type 6GY5.	16GY5
Refer to chart at end of section.	16KA6
Refer to type 6LU8.	16LU8A
Refer to chart at end of section.	17AB10
	17AB10/17X10
Refer to type 6AX3.	17AX3
Refer to chart at end of section.	17AX4GT
Refer to type 6AX4GTB.	17AX4GTA
Refer to chart at end of section.	17AY3
Refer to type 6AY3B.	17AY3A
Refer to chart at end of section.	17BB14
Refer to type 6BE3.	17BE3
Refer to type 6BE3.	17BE3/17BZ3
Refer to type 6BF11.	17BF11
Refer to chart at end of section.	17BH3
	17BH3A
Refer to chart at end of section.	17BQ6GTB
Refer to chart at end of section.	17BR3
Refer to type 6BR3/6RK19.	17BR3/17RK19
Refer to chart at end of section.	17BS3
Refer to type 6BS3A.	17BS3A
	17BS3A/17DW4A
Refer to type 22BW3.	17BW3
Refer to chart at end of section.	17BZ3
For replacement use type 17BE3/17BZ3.	
Refer to chart at end of section.	17C5
For replacement use type 17CU5/17C5.	
Refer to type 6C9.	17C9
Refer to chart at end of section.	17CK3
Refer to chart at end of section.	17CL3
Refer to type 12CT3.	17CT3

17CU5

For replacement use type 17CU5/17C5.

17CU5/17C5

Refer to type 6CU5.

17D4

Refer to chart at end of section.

17DE4

Refer to type 6DE4/6CQ4.

17DM4

Refer to chart at end of section.

17DM4A

Refer to type 6DM4A/6DA4.

17DQ6A

Refer to chart at end of section.

17DW4ARefer to chart at end of section.
For replacement use type 17BS3A/17DW4A.**17EW8**

Refer to chart at end of section.

**17EW8/
HCC85****HIGH-MU TWIN TRIODE**

Miniature type used in rf-amplifier and oscillator-mixer circuits in FM and AM radio receivers. Outlines section, 6B; requires miniature 9-contact socket.

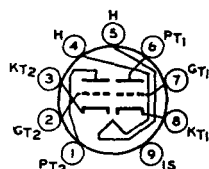
**9AJ**

Heater Voltage	17.5	volts
Heater Current	0.16	ampere
Peak Heater-Cathode Voltage	±90 max	volts
Direct Interelectrode Capacitances:		
Plate to Grid (Each Unit)	1.5	pF
Plate to Cathode (Each Unit)	0.18	pF
Plate to Cathode, Heater, and Internal Shield (Each Unit)	1.2	pF
Grid to Cathode, Heater, and Internal Shield (Each Unit)	3	pF
Plate of Unit No.1 to Plate of Unit No.2	0.04 max	pF
Grid of Unit No.1 to Grid of Unit No.2	0.003 max	pF
Plate of Unit No.1 to Grid of Unit No.2	0.008 max	pF
Plate of Unit No.2 to Grid of Unit No.1	0.008 max	pF
Plate of Unit No.1 to Cathode of Unit No.2	0.008 max	pF
Plate of Unit No.2 to Cathode of Unit No.1	0.008 max	pF
Grid of Unit No.1 to Triode of Unit No.2	0.003 max	pF
Grid of Unit No.2 to Triode of Unit No.1	0.003 max	pF

Class A₁ Amplifier (Each Unit)**MAXIMUM RATINGS (Design-Maximum Values)**

Plate Voltage	250	volts
Grid-Voltage, Negative-bias Value	100	volts
Cathode Current	15	mA
Plate Dissipation	2.5	watts

CHARACTERISTICS

Plate Voltage	100	170	200	volts
Grid Voltage	-1.1*	-1.5	-2.1	volts
Amplification Factor	50	50	48	
Transconductance	4600	6200	5800	μmhos
Plate Current	4.5	10	10	mA

MAXIMUM CIRCUIT VALUE

Grid-Circuit Resistance	1	megohm
-------------------------------	---	--------

* Should not be used if grid current is not permissible.

17GE5

Refer to type 6GE5.

Refer to chart at end of section.	17GJ5
Refer to type 6GJ5A.	17GJ5A
Refer to chart at end of section.	17GT5
Refer to type 6GT5A.	17GT5A
Refer to type 6GV5.	17GV5
Refer to chart at end of section.	17GW6/17DQ6B
Refer to chart at end of section.	17H3
Refer to chart at end of section.	17HB25
Refer to chart at end of section.	17JB6
Refer to type 6JB6A.	17JB6A
Refer to type 6JF6.	17JF6
Refer to chart at end of section.	17JG6
Refer to type 6JG6A.	17JG6A
Refer to chart at end of section.	17JM6
Refer to type 6JM6A.	17JM6A
Refer to type 6JN6.	17JN6
Refer to type 6JQ6.	17JQ6
Refer to type 6JR6.	17JR6
Refer to chart at end of section.	17JT6
Refer to type 6JT6A.	17JT6A
Refer to type 6JZ8.	17JZ8
Refer to chart at end of section.	17KV6
Refer to type 6KV6A.	17KV6A
Refer to chart at end of section. For replacement use type 15KY8A.	17LD8
For replacement use type 17BR3/17RK19.	17RK19
Refer to chart at end of section. For replacement use type 17AB10/17X10.	17X10
Refer to type 6Y9/EFL200.	17Y9
Refer to chart at end of section.	17Z3/PY81
Refer to chart at end of section.	18A5
Refer to chart at end of section.	18AJ10
Refer to chart at end of section.	18FW6 18FW6A
Refer to chart at end of section.	18FX6 18FX6A
Refer to chart at end of section.	18FY6 18FY6A

18GB5	Refer to chart at end of section.
18GB5/LL500	Refer to type 6GB5/EL500.
18GD6A	Refer to chart at end of section.
18GV8/PCL85	Refer to type 6GV8/ECL85.
19	Refer to chart at end of section.
19AU4	Refer to chart at end of section.
19AU4GTA	Refer to chart at end of section.
19BG6G	Refer to chart at end of section.
19BG6GA	
19CG3	For replacement use type 19CG3/19DQ3.
19CG3/19DQ3	Refer to type 6CG3.
19CL8A	Refer to chart at end of section.
	For replacement use type 19JN8/19CL8A.
19DE3	Refer to chart at end of section.

19DK3

HALF-WAVE VACUUM RECTIFIER

Novar type used as a damper tube in television receivers. Outlines section, 35A; requires novar 9-contact socket. Socket terminals 1, 3, 6, 8 and 9, should not be used as tie points.

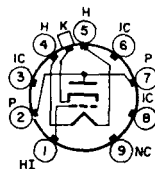

9SG

Heater Voltage (ac/dc)	19	volts
Heater Current	0.6	ampere
Heater Warm-up Time (Average)	11	seconds
Direct Interelectrode Capacitances:		
Cathode to Plate and Heater	22.0	pF
Plate to Cathode and Heater	13.6	pF
Heater to Cathode	1.1	pF

Damper Service

For operation in a 525-line, 30-frame system

Peak Inverse Plate Voltage#	6500	volts	
Peak Plate Current	1200	mA	
Average Plate Current	400	mA	
Plate Dissipation	9	watts	
Bulb Temperature (At hottest point)	220	°C	
Heater-Cathode Voltage:			
Peak value	+300	-6500	volts
Average value	+100	-900	volts

CHARACTERISTIC, Instantaneous Value

Tube Voltage Drop for plate current of 800 mA	25	volts
-----------------------------------------------	----	-------

Pulse duration must not exceed 15% of a horizontal scanning cycle.

19DQ3	For replacement use type 19CG3/19DQ3.
19EA8	Refer to type 6EA8.
19EZ8	Refer to chart at end of section.

Refer to type 12FX5.	19FX5
Refer to chart at end of section.	19GQ7
Refer to chart at end of section.	19HR6
Refer to chart at end of section.	19HS6
Refer to chart at end of section.	19HV8
Refer to chart at end of section.	19J6
Refer to chart at end of section.	19JN8
Refer to type 6JN8.	19JN8/19CL8A
Refer to chart at end of section.	19KG8
For replacement use type 18GD6A.	19MR9
For replacement use type 18FW6A.	19MR19
Refer to chart at end of section.	19Q9
Refer to type 6X8A.	19X8
Refer to chart at end of section.	20
Refer to type 16AQ3/XY88.	20AQ3/LY88
Refer to chart at end of section.	20EQ7
Refer to chart at end of section.	20EZ7
Refer to type 6LF6/6LX6.	20LF6
Refer to chart at end of section.	21EX6
Refer to type 6GY5.	21GY5
Refer to chart at end of section.	21HB5

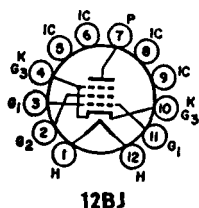

BEAM POWER TUBE

21HB5A

Duodecares type used as horizontal-deflection amplifier in television receivers. Outlines section, 15B; requires duodecares 12-contact socket. For maximum ratings, refer to type 6HB5. Heater: volts (ac/dc), 21; amperes, 0.45; warm-up time (average), 11 seconds; maximum heater-cathode volts, ± 200 peak, 100 average.

Class A₁ Amplifier

CHARACTERISTICS	Pentode Connection			Triode* Connection	volts volts volts ohms μ mhos
	5000	50	130	130	
Plate Voltage	5000	50	130	130	volts
Grid-No.2 (Screen-Grid) Voltage	130	130	130	130	volts
Grid-No.1 (Control-Grid) Voltage	—	0	-20	-20	volts
Amplification Factor	—	—	—	4.8	
Plate Resistance (Approx.)	—	—	9900	—	ohms
Transconductance	—	—	9000	—	μ mhos

Plate Current	—	450*	46	—	mA
Grid-No.2 Current	—	29*	1.8	—	mA
Grid-No.1 Voltage (Approx.) for plate current of 1 mA	—64	—	—32	—	volts

* Grid-No.2 tied to plate

* This value can be measured by a method involving a recurrent waveform such that the maximum ratings of the tube will not be exceeded.

21HJ5

Refer to chart at end of section.

21JS6A

For replacement use type 23JS6A.

21JV6

Refer to chart at end of section.

21JZ6**BEAM POWER TUBE**

Duodecar type used as horizontal-deflection amplifier in television receivers. Outlines section, 39A; requires duodecar 12-contact socket. Heater: volts (ac/dc), 21; amperes, 0.45; average warm-up time, 11 seconds; maximum heater-cathode volts, ± 200 peak, 100 average.

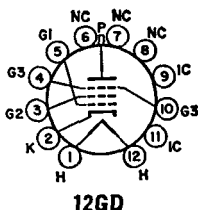
**12GD****Class A₁ Amplifier**

CHARACTERISTICS	Triode ^a		Pentode Connection		
	Connection				
Plate Voltage	13J	5000	50	130	volts
Grid No.3 (Suppressor Grid)	—	—	Connected to cathode at socket		
Grid-No.2 (Screen-Grid) Voltage	—	130	130	130	volts
Grid-No.1 (Control-Grid) Voltage	—20	—	0	—20	volts
Amplification Factor	4.8	—	—	—	
Plate Resistance (Approx.)	—	—	—	9900	ohms
Transconductance	—	—	—	9000	μ mhos
Plate Current	—	—	450	46	mA
Grid-No.2 Current	—	—	29	1.8	mA
Grid-No.1 Voltage (Approx.) for plate current of 1.0 mA	—	—64	—	—32	volts

^a Grid No.2 connected to plate.

Horizontal-Deflection Amplifier

For operation in a 525-line, 30-frame system

MAXIMUM RATINGS (Design-Maximum Values)

Plate Supply Voltage	770	volts
Peak Positive-Pulse Plate Voltage [#]	6500	volts
Peak Negative-Pulse Plate Voltage	1500	volts
DC Grid-No.3 Voltage, Positive-bias value	70	volts
Grid-No.2 Voltage	220	volts
DC Grid-No.1 Voltage, Negative-bias value	55	volts
Peak Negative-Pulse Grid-No.1 Voltage	330	volts
Peak Cathode Current	800	mA
Average Cathode Current	230	mA
Plate Dissipation*	18	watts
Grid-No.2 Input	3.5	watts
Bulb Temperature (At hottest point)	220	$^{\circ}$ C

MAXIMUM CIRCUIT VALUE

Grid-No.1-Circuit Resistance	1	megohm
------------------------------------	---	--------

* A bias resistor or other means is required to protect the tube in absence of excitation.

[#] Pulse duration must not exceed 15% of a horizontal scanning cycle (10 microseconds).

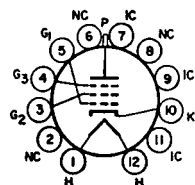

12GH

BEAM POWER TUBE

21KA6

Duodecar type used as horizontal-deflection amplifier in television receivers. Outlines section, 16A; requires duodecar 12-contact socket. A separate connection is provided for grid No.3 to minimize "snivets."

Heater Voltage	21	volts
Heater Current	0.45	ampere
Heater Warm-up Time	11	seconds
Heater-Cathode Voltage:		
Peak value	±200 max	volts
Average value	100 max	volts

Class A₁ Amplifier

CHARACTERISTICS

Plate Voltage	5000	60	60	130	volts
Grid-No.3 (Suppressor-Grid) Voltage	0	0	25	0	volts
Grid-No.2 (Screen-Grid) Voltage	130	130	130	130	volts
Grid-No.1 (Control-Grid) Voltage	—	0	0	—20	volts
Plate Resistance (Approx.)	—	—	—	11000	ohms
Transconductance	—	—	—	9100	μmhos
Plate Current	—	410*	410*	50	mA
Grid-No.3 Current	—	—	2	—	mA
Grid-No.2 Current	—	24*	23*	1.75	mA
Grid-No.1 Voltage (Approx.) for plate current of 1 mA	—66	—	—	—33	volts
Triode Amplification Factor	—	—	—	4.7	

* This value may be measured by a method involving a recurrent waveform such that the maximum ratings of the tube will not be exceeded.

Horizontal-Deflection Amplifier

For operation in a 525-line, 30-frame system

MAXIMUM RATINGS (Design-Maximum Values)

DC Plate Supply Voltage	770	volts
Peak Positive-Pulse Plate Voltage#	6500	volts
Peak Negative-Pulse Plate Voltage	1500	volts
Grid-No.3 Voltage, Positive-bias value	70	volts
Grid-No.2 Voltage	220	volts
Grid-No.1 Voltage, Negative-bias value	55	volts
Peak Negative-Pulse Grid-No.1 Voltage	330	volts
Average Cathode Current	230	mA
Peak Cathode Current	800	mA
Plate Dissipation	18	watts
Grid-No.2 Input	3.5	watts
Bulb Temperature (At hottest point)	220	°C

MAXIMUM CIRCUIT VALUE

Grid-No.1-Circuit Resistance	1	megohm
------------------------------	---	--------

Pulse duration must not exceed 15% of a horizontal scanning cycle (10 microseconds).

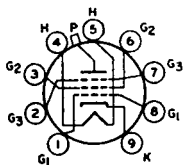

9RJ

BEAM POWER TUBE

21KQ6

29KQ6/PL521

Magnoval type used as horizontal-deflection amplifier in television receivers. Outlines section, 40A; requires magnoval 9-contact socket. Type 29KQ6/PL521 is identical with type 21KQ6 except for heater ratings.

Heater Voltage	21KQ6	29KQ6/PL521	
Heater Current	21.5	29	volts
	0.45	0.3	ampere

Heater-Cathode Voltage:			
Peak value	±240	±240	volts
Average value	±240	±240	volts

Class A₁ Amplifier

CHARACTERISTICS

Plate Voltage	40	50	volts
Grid-No.3 (Suppressor-Grid) Voltage	0	0	volts
Grid-No.2 (Screen-Grid) Voltage	135	200	volts
Grid-No.1 (Control-Grid) Voltage	0	-12	volts
Plate Current	450	550†	mA
Grid-No.2 Current	35	50†	mA
Grid-No.1 Voltage for plate current of 50 μ A	-55 max.	—	volts

† This value can be measured by a method involving a recurrent waveform such that the maximum ratings of the tube will not be exceeded.

Horizontal-Deflection Amplifier

For operation in a 525-line, 30-frame system

MAXIMUM RATINGS (Design-Maximum Values)

Plate Voltage	275	volts
Peak Positive-Pulse Plate Voltage#	6500	volts
Peak Negative-Pulse Plate Voltage#	1650	volts
Grid-No.3 Voltage	70	volts
Grid-No.2 Voltage	275	volts
Peak Negative-Pulse Grid-No.1 Voltage	330	volts
Average Cathode Current	275	mA

MAXIMUM CIRCUIT VALUES

Grid-No.1-Circuit Resistance	0.5	megohms
Grid-No.1-Circuit Resistance, for horizontal-deflection circuit	2.2	megohms

Pulse duration must not exceed 22% of a horizontal scanning cycle (18 microseconds).

21LG6

Refer to chart at end of section.

21LG6A

BEAM POWER TUBE

Duodecar type used as horizontal-deflection amplifier in color television receivers. Outlines section, 16B; requires duodecar 12-contact socket. Heater: volts, 21; ampere, 0.6; maximum heater-cathode volts, \pm 200 peak, 100 average.

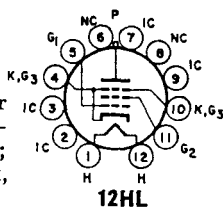

Class A₁ Amplifier

CHARACTERISTICS	Triode* Connection		Pentode Connection		
	125	6000	50	175	
Plate Voltage	125	6000	50	175	volts
Grid-No.2 (Screen-Grid) Voltage	125	125	125	125	volts
Grid-No.1 (Control-Grid) Voltage	-25	—	0	-23	volts
Plate Resistance (Approx.)	—	—	—	7500	ohms
Transconductance	—	—	—	11500	μ mhos
Plate Current	—	—	600	90	mA
Grid-No.2 Current	—	—	42	1.7	mA
Grid-No.1 Voltage (Approx.) for plate current of 1 mA	—	-115	—	-45	volts
Amplification Factor	3.6	—	—	—	—

Horizontal-Deflection Amplifier

For operation in a 525-line, 30-frame system

MAXIMUM RATINGS (Design-Maximum Values)

DC Plate Supply Voltage	900	volts
Peak Positive-Pulse Plate Voltage#	7500	volts
Peak Negative-Pulse Plate Voltage	100	volts

Grid-No.2 Voltage	250	volts
Grid-No.1 Voltage, Negative-bias value	300	volts
Plate Dissipation ■	28	watts
Grid-No.2 Input	5	watts
Average Cathode Current	315	mA
Peak Cathode Current	1100	mA
Bulb Temperature	250	°C

MAXIMUM CIRCUIT VALUES

Grid-No.1 Circuit Resistance:		
With feedback type high voltage regulation	1.8	megohms
With shunt-type high voltage regulation (switching mode)	2.2	megohms

* Grid-No. 2 tied to plate.

Pulse duration must not exceed 15% of a horizontal scanning cycle (10 microseconds).

■ A bias resistor or other means is required to protect the tube in absence of excitation.

- | | |
|-----------------------------------|---------------|
| Refer to type 6LR8. | 21LR8 |
| Refer to type 6LU8. | 21LU8 |
| Refer to chart at end of section. | 21MY8 |
| Refer to chart at end of section. | 22 |
| Refer to chart at end of section. | 22BH3 |
| Refer to chart at end of section. | 22BH3A |

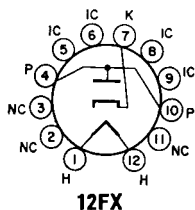

**HALF-WAVE
VACUUM RECTIFIER**

22BW3
17BW3

Duodecar type used as damper tube in horizontal-deflection circuits of television receivers. Outlines section, 8D; requires duodecar 12-contact socket. Type 17BW3 is identical with type 22BW3 except for heater ratings.

Heater Voltage (ac/dc)	17BW3	22BW3	
Heater Current	16.8	22.4	volts
Heater Warm-up Time	0.6	0.45	ampere
	11	11	seconds
Direct Interelectrode Capacitances:			
Cathode to Heater and Plate		8.5	pF
Plate to Cathode and Heater		6	pF
Heater to Cathode		3.8	pF

Damper Service

For operation in a 525-line, 30-frame system

MAXIMUM RATINGS (Design-Maximum Values)

Peak Inverse Plate Voltage#	5000	volts	
Peak Plate Current	1100	mA	
Average Plate Current	175	mA	
Plate Dissipation	6.5	watts	
Heater-Cathode Voltage:			
Peak value	+300	-5000	volts
Average value	+100	-900	volts

CHARACTERISTICS, Instantaneous Value

Tube Voltage Drop for plate current of 350 mA	32	volts
# Pulse duration must not exceed 15% of one horizontal scanning cycle (10 microseconds).		

- | | |
|-----------------------------------|---------------|
| Refer to type 6DE4/6CQ4. | 22DE4 |
| Refer to type 6JF6. | 22JF6 |
| Refer to chart at end of section. | 22JG6 |
| Refer to type 6JG6A. | 22JG6A |

22JR6	Refer to type 6JR6.
22JU6	Refer to type 6JU6.
22KM6	Refer to type 6KM6.
22KV6A	Refer to type 6KV6A.
23JS6A	Refer to type 6JS6C.

23Z9**DUAL TRIODE—
BEAM POWER TUBE**

Duodecar type used in combined vertical-deflection-oscillator and vertical-deflection-amplifier applications in television receivers. Outlines section, 8B; requires duodecar 12-contact socket. Heater: volts (ac/dc), 23; amperes, 0.45; average warm-up time, 11 seconds; maximum heater-cathode volts, ± 200 peak, 100 average.

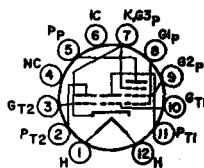

12GZ

Class A₁ Amplifier

CHARACTERISTICS	Triode	Triode	Beam Power		
	Unit No.1	Unit No.2	Unit	Unit	
Plate Voltage	150	150	45	120	volts
Grid-No.2 (Screen-Grid) Voltage	—	—	110	110	volts
Grid-No.1 (Control-Grid) Voltage	-2	-5	0	-8	volts
Amplification Factor	43	20	—	—	
Plate Resistance (Approx.)	11000	8500	—	11700	ohms
Transconductance	3900	2350	—	7100	μ mhos
Plate Current	5.4	5.5	122	46	mA
Grid-No.2 Current	—	—	16.5	3.5	mA
Grid-No.1 Voltage (Approx.) for plate current of 100 μ A	—	—	—	-25	volts
Grid Voltage (Approx.) for plate current of 10 μ A	-5.7	-11	—	—	volts

Vertical-Deflection Oscillator and Amplifier

For operation in a 525-line, 30-frame system

MAXIMUM RATINGS (Design-Maximum Values)	Triode	Triode	Beam Power		
	Unit No.1	Unit No.2	Unit	Unit	
Plate Voltage	330	250	250	2000	volts
Peak Positive-Pulse Plate Voltage#	—	—	—	200	volts
Grid-No.2 Voltage	—	—	400	150	volts
Peak Negative-Pulse Grid-No.1 Voltage	—	—	—	—	volts
Grid Voltage, Positive-bias value	0	—	—	—	volts
Plate Dissipation	125	1	—	7	watts
Grid-No.2 Input	—	—	—	1.8	watts
Peak Cathode Current	—	—	—	245	mA
Average Cathode Current	—	—	—	70	mA
Peak Plate Current	—	—	70	—	mA
Average Plate Current	—	—	20	—	mA

MAXIMUM CIRCUIT VALUES

Grid-No.1-Circuit Resistance:			
For fixed-bias operation	0.5	1	1 megohm

Pulse duration must not exceed 15% of a horizontal scanning cycle (10 microseconds).

24A	Refer to chart at end of section.
24BF11	Refer to type 6BF11.
24JE6A	Refer to chart at end of section. For replacement use type 24LQ6/24JE6C.
24JE6C	For replacement use type 24LQ6/24JE6C.
24JZ8	Refer to type 6JZ8.

For replacement use type 24LQ6/24JE6C.	24LQ6
Refer to type 6MJ6/6LQ6/6JE6C.	24LQ6/24JE6C
Refer to chart at end of section.	24LZ6
Refer to chart at end of section.	25A6
Refer to chart at end of section.	25A6GT
Refer to chart at end of section.	25A7GT
Refer to chart at end of section.	25AC5GT
Refer to type 6AV5GA.	25AV5GA
Refer to chart at end of section.	25AX4GT
Refer to chart at end of section.	25B5
Refer to chart at end of section.	25B6G
Refer to chart at end of section.	25B8GT
Refer to chart at end of section.	25BK5
Refer to chart at end of section.	25BQ6GT
Refer to type 6BQ6GTB/6CU6.	25BQ6GTB/25CU6
Refer to type 50C5.	25C5
Refer to chart at end of section.	25C6G
Refer to chart at end of section.	25CA5
For replacement use type 25C5.	
Refer to chart at end of section.	25CD6GA
Refer to type 6CD6GA.	25CD6GB
Refer to type 6CG3.	25CG3
Refer to chart at end of section.	25CK3
Refer to chart at end of section.	25CM3
Refer to type 12CT3.	25CT3
Refer to type 6BQ6GTB/6CU6.	25CU6
Refer to type 6DL3.	25DL3
Refer to chart at end of section.	25DN6
Refer to chart at end of section.	25E5/PL36
Refer to chart at end of section.	25EC6
Refer to type 6EH5.	25EH5
Refer to chart at end of section.	25F5A
Refer to chart at end of section.	25HX5
Refer to chart at end of section.	25JQ6
Refer to type 6JZ8.	25JZ8
Refer to chart at end of section.	25L6

25L6GT/25W6GT	Refer to chart at end of section.
25N6G	Refer to chart at end of section.
25W4GT	Refer to chart at end of section.
25W6GT	For replacement use type 25L6GT/25W6GT Refer to chart at end of section.
25Y5	Refer to chart at end of section.
25Z5	Refer to chart at end of section.
25Z6 25Z6GT	Refer to chart at end of section.
26	Refer to chart at end of section.
26A6	Refer to chart at end of section.
26A7GT	Refer to chart at end of section.
26C6	Refer to chart at end of section.
26D6	Refer to chart at end of section.

26HU5**BEAM POWER TUBE**

Glass octal type used as horizontal-deflection amplifier in color television receivers. Outlines section, 21B; requires octal socket. Heater: volts (ac/dc), 26; ampere, 0.6; warm-up time (average), 11 seconds; maximum heater-cathode volts, ± 200 peak, 100 average.

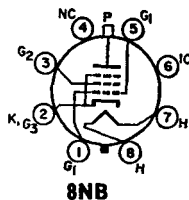
**Class A₁ Amplifier****CHARACTERISTICS**

CHARACTERISTICS	Triode† Connection		Pentode Connection		
	Plate Voltage	150	45	60	
Grid-No.2 (Screen-Grid) Voltage	150	160	110	110	volts
Grid-No.1 (Control-Grid) Voltage	-22.5	0	0	-21	volts
Plate Resistance (Approx.)	—	—	—	6000	ohms
Transconductance	—	—	—	14000	μmhos
Plate Current	—	1100*	750*	125	mA
Grid-No.2 Current	—	110*	42*	3.3	mA
Grid-No.1 Voltage (Approx.) for plate current of 1 mA	—	—	—	-40	volts
Amplification Factor	4	—	—	—	—

† Grid No.2 tied to plate.

* This value can be measured by a method involving a recurrent waveform such that the maximum ratings of the tube will not be exceeded.

Horizontal-Deflection Amplifier

For operation in a 525-line, 30-frame system

MAXIMUM RATINGS (Design-Maximum Values)

DC Plate Supply Voltage	990	volts
Peak Positive Pulse Plate Voltage#	7000	volts
Grid-No.2 Voltage	250	volts
Grid-No.1 Voltage, Negative-bias value	250	volts
Plate Dissipation* (Absolute-maximum value)	33	watts
Grid-No.2 Input	5	watts
Average Cathode Current	400	mA
Peak Cathode Current	1400	mA
Bulb Temperature (At hottest point)	250	°C

Pulse duration must not exceed 15% of a horizontal scanning cycle (10 microseconds).
 * A bias resistor or other means is required to protect the tube in absence of excitation.

MAXIMUM CIRCUIT VALUES

Grid-No.1-Circuit Resistance:		
With Feedback-type high voltage regulation	1.2	megohms
With Shunt-type high voltage regulation (switching mode) ...	2.2	megohms

Refer to chart at end of section.

26LW6

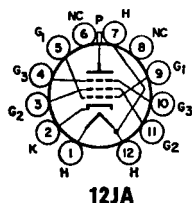

12JA

BEAM POWER TUBE

26LX6

Duodecar type used as a horizontal-deflection amplifier in color and black-and-white television receivers. Out-lines section, 16C; requires duodecar 12-contact socket. Heater: volts (ac/dc), 26; ampere, 0.6; warm-up time, 11 seconds; maximum heater-cathode volts, ±200 peak, 100 average.

Class A₁ Amplifier

CHARACTERISTICS	Triode* Connection		Pentode Connection		
	175	5000	45	175	
Plate Voltage	175	5000	45	175	volts
Grid-No. 3 (Suppressor-Grid)	—	—	Connected to cathode at socket		
Grid-No. 2 (Screen-Grid) Voltage	175	110	160	110	volts
Grid-No. 1 (Control-Grid) Voltage	-21	—	0	-21	volts
Plate Resistance (Approx.)	—	—	—	6000	ohms
Transconductance	—	—	—	14000	μmhos
Plate Current	—	—	1100‡	125	mA
Grid-No. 2 Current	—	—	110‡	3.3	mA
Grid-No. 1 Voltage (Approx.) for plate current of 1 mA	—	-125	—	—	volts
Amplification Factor	4	—	—	—	

* Grid-No. 2 tied to plate.

‡ This value may be measured by a method involving a recurrent waveform such that the maximum ratings of the tube will not be exceeded.

Horizontal-Deflection Amplifier

For operation in a 525-line, 30-frame system

MAXIMUM RATINGS (Design-Maximum Values)

DC Plate Supply Voltage	990	volts
Peak Positive Pulse Plate Voltage# (Absolute Maximum Value) ..	7000	volts
Peak Negative-Pulse Plate Voltage	100	volts
Grid-No. 3 Voltage, Positive-bias value	0	volts
Grid-No. 2 Voltage	250	volts
Peak Negative Grid-No. 1 Voltage	250	volts
Peak Cathode Current	1400	mA
Average Cathode Current	400	mA
Plate Dissipation# (Absolute Maximum Value)	33	watts
Grid-No. 2 Input	5	watts
Bulb Temperature (At hottest point)	240	°C

MAXIMUM CIRCUIT VALUES

Grid-No.1-Circuit Resistance:		
With feedback-type high voltage regulation	1.2	megohms
With shunt-type high voltage regulation (switching mode) ...	2.2	megohms
Grid-No.3-Circuit Resistance	0	ohms

MINIMUM RECOMMENDED GRID DRIVE

Peak Positive Pulse Plate Voltage	5000	6000	volts
Peak Negative Grid-No. 1 Voltage for grid-No. 2 voltage of 150 volts	-190	-210	volts
Peak Negative Grid-No. 1 Voltage for grid-No. 2 voltage of 200 volts	-210	-235	volts

Pulse duration must not exceed 15% of a horizontal scanning cycle (10 microseconds).

A bias resistor or other means is required to protect the tube in absence of excitation.

27

27GB5/PL500

29KQ6/PL521

Refer to chart at end of section.

Refer to type 6GB5/EL500.

Refer to chart at end of section.

29LE6

BEAM POWER TUBE

Magnoval type used as horizontal-deflection amplifier in television receivers. Outlines section, 40A; requires magnoval 9-contact socket.

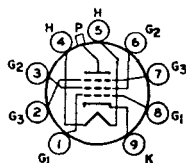

9RJ

Heater Voltage	29	volts
Heater Current	0.3	ampere
Heater-Cathode Voltage:		
Peak value	±240	volts
Average value	±240	volts

Class A₁ Amplifier

CHARACTERISTICS

Plate Voltage	40	50	volts
Grid-No.3 (Suppressor-Grid) Voltage	0	0	volts
Grid-No.2 (Screen-Grid) Voltage	135	200	volts
Grid-No.1 (Control-Grid) Voltage	0	-12	volts
Plate Current	450	550‡	mA
Grid-No.2 Current	35	50‡	mA
Grid-No.1 Voltage for plate current of 50 μ A	-55 max.	—	volts

‡ This value can be measured by a method involving a recurrent waveform such that the maximum ratings of the tube will not be exceeded.

Horizontal-Deflection Amplifier

For operation in a 525-line, 30-frame system

MAXIMUM RATINGS (Design-Maximum Values)

Plate Voltage	275	volts
Peak Positive-Pulse Plate Voltage#	6500	volts
Peak Negative-Pulse Plate Voltage#	1650	volts
Grid-No.3 Voltage	70	volts
Grid-No.2 Voltage	275	volts
Peak Negative-Pulse Grid-No.1 Voltage	330	volts
Average Cathode Current	275	mA

MAXIMUM CIRCUIT VALUES

Grid-No.1-Circuit Resistance	0.5	megohm
Grid-No.1-Circuit Resistance, for horizontal-deflection circuit	2.2	megohms

Pulse duration must not exceed 22% of a horizontal scanning cycle (18 microseconds).

30

Refer to chart at end of section.

30AE3/
PY88

DIODE

Miniature type used as booster diodes in line-time-base circuits of transformerless television receivers. Outlines section, 7D; requires miniature 9-contact socket. Heater: volts (ac/dc), 30; amperes, 0.3; maximum heater-cathode volts, 6600 peak.

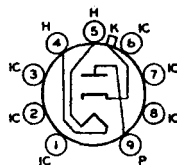

9CB

MAXIMUM RATINGS (Design-Center Values)

Supply Voltage at zero current	550	volts
Supply Voltage	250	volts
Peak Plate Current	550	mA

Average Plate Current	220	mA
Plate Dissipation	5	watts
Peak Negative-Pulse Plate Voltage*	6000#	volts

* Under no conditions should an absolute maximum value of 7500 volts be exceeded.
 # The pulse duration must not exceed 22 per cent of a cycle, or a maximum of 18 micro-seconds.

Refer to chart at end of section.	30AG11
Refer to chart at end of section.	30JZ6
Refer to type 6KD6.	30KD6
Refer to chart at end of section.	30MB6
Refer to chart at end of section.	31
Refer to chart at end of section.	31AL10
Refer to chart at end of section.	31JS6A
Refer to type 6JS6C.	31JS6C
Refer to type 6MJ6/6LQ6/6JE6C.	31LQ6
Refer to type 6LR8.	31LR8

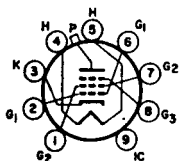

9QL

BEAM POWER TUBE

31LZ6

Novar type used for horizontal-deflection amplifier in color television receivers. Outlines section, 32C; requires novar 9-contact socket.

Heater Voltage (ac/dc)	31	volts
Heater Current	0.45	ampere
Heater Warm-up Time	11	seconds
Heater-Cathode Voltage:		
Peak value	±200 max	volts
Average value	100 max	volts
Direct Interelectrode Capacitances:		
Grid No.1 to Plate	0.6	pF
Grid No.1 to Cathode, Heater, Grid No.2, and Grid No.3	22	pF
Plate to Cathode, Heater, Grid No.2, and Grid No.3	11	pF

Class A₁ Amplifier

CHARACTERISTICS	Triode† Connection		Pentode Connection		
	125	5000	55	175	
Plate Voltage	—	—	—	—	volts
Peak Positive-Pulse Plate Voltage#	—	5000	—	—	volts
Grid No.3 (Suppressor Grid)	—	30	30	30	volts
Grid-No.2 (Screen-Grid) Voltage	125	130	125	125	volts
Grid-No.1 (Control-Grid) Voltage	-25	—	0	-25	volts
Amplification Factor	3	—	—	—	
Plate Resistance (Approx.)	—	—	—	6000	ohms
Transconductance	—	—	—	11000	μmhos
Plate Current	—	—	800††	140	mA
Grid-No.2 Current	—	—	56††	2	mA
Grid-No.1 Voltage for plate current of 1 mA	—	-125	—	-50	volts

Horizontal-Deflection Amplifier

For operation in a 525-line, 30-frame system

MAXIMUM RATINGS (Design-Maximum Values)		
DC Plate Supply Voltage	990	volts
Peak Positive-Pulse Plate Voltage#	7500	volts
Peak Negative-Pulse Plate Voltage	1100	volts
DC Grid-No.3 Voltage#	75	volts

DC Grid-No.2 Voltage	220	volts
Peak Negative-Pulse Grid-No.1 Voltage	330	volts
Peak Cathode Current	1200	mA
Average Cathode Current	350	mA
Grid-No.2 Input	5	watts
Plate Dissipation [■]	30	watts
Bulb Temperature (At hottest point)	240	°C

MAXIMUM CIRCUIT VALUES

Grid-No.1-Circuit Resistance:		
For cathode-bias operation	1	megohm
For grid-leak-bias operation	10	megohms
For fixed-bias operation	0.47	megohm

Pulse duration must not exceed 15% of one horizontal scanning cycle (10 microseconds).
 † Grid No.2 connected to plate.

‡ This value can be measured by a method involving a recurrent waveform such that the maximum ratings of the tube will not be exceeded.

■ In this service, a positive value may be applied to grid No.3 to minimize "snivets" interference; a typical value for this voltage is 30 volts.

■ A bias resistor or other means is required to protect the tube in absence of excitation.

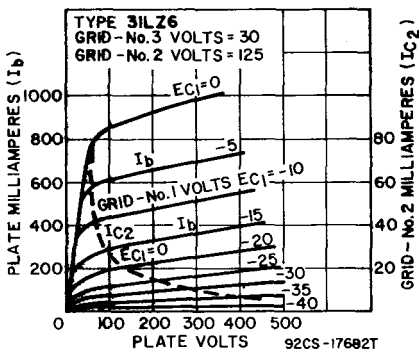
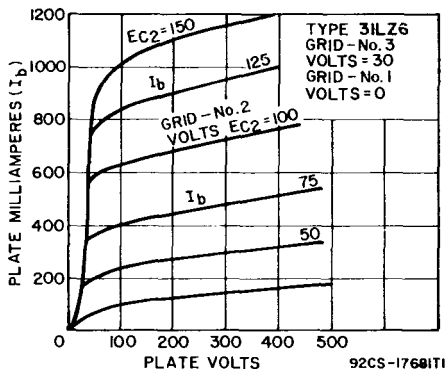

- | | |
|---------------|-----------------------------------|
| 32 | Refer to chart at end of section. |
| 32ET5 | Refer to chart at end of section. |
| 32ET5A | Refer to chart at end of section. |
| 32HQ7 | Refer to chart at end of section. |
| 32L7GT | Refer to chart at end of section. |
| 33 | Refer to chart at end of section. |
| 33GT7 | Refer to chart at end of section. |
| 33GY7 | Refer to chart at end of section. |

33GY7A DIODE-BEAM POWER TUBE

50GY7A

Duodecar type used as combined damper diode and horizontal-deflection amplifier in television receivers. Socket terminals 1, 3, 6 and 7 should not be used as tie points. Outlines section, 15A; requires duodecar 12-contact socket. Type 50GY7A is identical with type 33GY7A except for heater ratings.

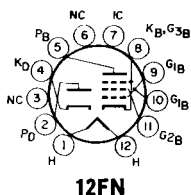

	33GY7A	50GY7A	
Heater Voltage (ac/dc)	33.6	50	volts
Heater Current	0.45	0.3	ampere
Heater Warm-up Time (Average)	11	11	seconds
Heater-Cathode Voltage:			
Peak value	±200 max	±200 max	volts
Average value	100 max	100 max	volts

Beam Power Unit as Class A₁ Amplifier

CHARACTERISTICS	Pentode Connection			Triode* Connection	
Plate Voltage	5000	60	130	130	volts
Grid-No.2 (Screen-Grid) Voltage	130	130	130	130	volta
Grid-No.1 (Control-Grid) Voltage	—	0	-22.5	-22.5	volts
Amplification Factor	—	—	—	4	
Plate Resistance (Approx.)	—	—	10000	—	ohms
Transconductance	—	—	6500	—	μmhos
Plate Current	—	320*	48	—	mA
Grid-No.2 Current	—	22*	2.9	—	mA
Grid-No.1 Voltage (Approx.) for plate current of 1 mA	-80	—	-40	—	volts

* Grid No.2 tied to plate.

* This value can be measured by a method involving a recurrent waveform such that the maximum ratings of the tube will not be exceeded.

Beam Power Unit as Horizontal-Deflection Amplifier

For operation in a 525-line, 50-frame system

MAXIMUM RATINGS (Design-Maximum Values)

DC Plate Supply Voltage	400	volts
Peak Positive-Pulse Plate Voltage#	5000	volts
Peak Negative-Pulse Plate Voltage	0	volts
DC Grid-No.2 Voltage	150	volts
DC Grid-No.1 Voltage	-55	volts
Peak Negative-Pulse Grid-No.1 Voltage	330	volts
Peak Cathode Current	540	mA
Average Cathode Current	155	mA
Plate Dissipation†	9	watts
Grid-No.2 Input	3	watts

MAXIMUM CIRCUIT VALUE

Grid-No.1-Circuit Resistance	1	megohm
------------------------------	---	--------

Pulse duration must not exceed 15% of a horizontal scanning cycle (10 microseconds).

† A bias resistor or other means is required to protect the tube in absence of excitation.

Damper Service (Diode Unit)

For operation in a 525-line, 30-frame system

MAXIMUM RATINGS (Design-Maximum Values)

Peak Inverse Plate Voltage#	4200	volts	
Peak Plate Current	810	mA	
Average Plate Current	135	mA	
Plate Dissipation	3.8	watts	
Heater-Cathode Voltage:			
Peak value	+200	-4200	volts
Average value	+100	-400	volts
Bulb Temperature (At hottest point)	200	°C	

CHARACTERISTICS, Instantaneous Value

Tube Voltage Drop for plate current of 250 mA	21	volts
-----------------------------------------------	----	-------

Pulse duration must not exceed 15% of a horizontal scanning cycle (10 microseconds).

Refer to type 6JR6.

33JR6

Refer to chart at end of section.

33JV6

Refer to chart at end of section.

34

Refer to type 6CE3/6CD3/6DT3.

34CE3

Refer to chart at end of section.

34CM3

34GD5	Refer to chart at end of section.
34GD5A	Refer to chart at end of section.
34R3	Refer to chart at end of section.
35	Refer to chart at end of section.
35A5	Refer to chart at end of section.
35B5	Refer to chart at end of section.

35C5 BEAM POWER TUBE

Miniature type used in output stage of compact, ac/dc radio receivers. **Outlines section, 5D**; requires miniature 7-contact socket. This tube, like other power-handling tubes, should be adequately ventilated. Except for terminal connections and slightly higher ratings, type 35C5 is equivalent in performance to miniature type 35B5 and, within its maximum ratings, to glass octal type 35L6GT.

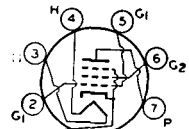

7CV

Heater Voltage (ac/dc)	35	volts
Heater Current	0.15	ampere
Heater-Cathode Voltage:		
Peak value	±200 max	volts
Average value	100 max	volts
Direct Interelectrode Capacitances (Approx.):		
Grid No.1 to Plate	0.6	pF
Grid No.1 to Cathode, Heater, Grid No.2, and Grid No.3	12	pF
Plate to Cathode, Heater, Grid No.2, and Grid No.3	9	pF

Class A₁ Amplifier

MAXIMUM RATINGS (Design-Maximum Values)		
Plate Voltage	150	volts
Grid-No.2 (Screen-Grid) Voltage	130	volts
Plate Dissipation	5.2	watts
Grid-No.2 Input	1.1	watts
Bulb Temperature (At hottest point)	250	°C

TYPICAL OPERATION

Plate Voltage	110	volts
Grid-No.2 Voltage	110	volts
Grid-No.1 (Control-Grid) Voltage	-7.5	volts
Peak AF Grid-No.1 Voltage	7.5	volts
Zero-Signal Plate Current	40	mA
Maximum-Signal Plate Current	41	mA
Zero-Signal Grid-No.2 Current	3	mA
Maximum-Signal Grid-No.2 Current	7	mA
Plate Resistance (Approx.)	13000	ohms
Transconductance	5800	μmhos
Load Resistance	2500	ohms
Total Harmonic Distortion	10	per cent
Maximum-Signal Power Output	1.5	watts

MAXIMUM CIRCUIT VALUES

Grid-No.1-Circuit Resistance:		
For fixed-bias operation	0.1	megohm
For cathode-bias operation	0.5	megohm

Installation and Application

The 35-volt heater is designed to operate under the normal conditions of line-voltage variation without materially affecting the performance or serviceability of the 35C5. For operation of the 35C5 in series with other types having 0.15-ampere rating, the current in the heater circuit should be adjusted to 0.15 ampere for the normal supply voltage.

In a series-heater circuit of the "dc-power line" type employing several 0.15-ampere types and one or two 35C5s, the heater(s) of the 35C5(s) should be placed on the positive side of the line. Under these conditions, heater-cathode voltage of the 35C5 must not exceed the value given under maximum ratings. In a series-heater circuit of the "universal" type employing rectifier tube 35W4, one or two 35C5s and several 0.15-ampere types, it is recommended that the heater(s) of the 35C5(s) be placed in the circuit so that the higher values of heater-cathode bias will be impressed on the 35C5(s) rather than on the other 0.15-ampere types. This is accomplished by arranging the 35C5(s) on the side of the supply line which is connected to the cathode of the rectifier, i.e., the positive terminal of the rectified voltage supply. Between this side of the line and the 35C5(s), any necessary auxiliary resistance and the heater of the 35W4 are connected in series.

As a power amplifier (class A₁), the 35C5 is recommended for use either singly or in push-pull combination in the power-output stage of ac/dc receivers. The operating values shown under typical operation have been determined on the basis that grid-No.1 current does not flow during any part of the input cycle.

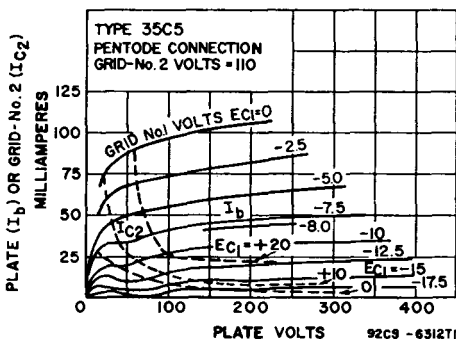

Refer to chart at end of section.

35DZ8

Refer to chart at end of section.

35EH5

Refer to chart at end of section.

35GL6

Refer to chart at end of section.

35L6GT

Refer to type 6LR6.

35LR6

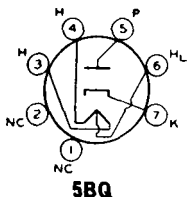

5BQ

**HALF-WAVE
VACUUM RECTIFIER**

35W4

Miniature type used in power supply of ac/dc receivers. Outlines section, 5D; requires miniature 7-contact socket. This type is equivalent in performance to glass-octal type 35Z5GT. The heater is provided with a tap for operation of a panel lamp.

Heater Voltage (ac/dc):	*	**	
Entire Heater (pins 3 and 4)	35	32	volts
Panel Lamp Section (pins 4 and 6)	7.5	5.5	volts
Heater Current:			
Between Pins 3 and 4	0.15	—	ampere
Between Pins 3 and 6	—	0.15	ampere
Peak Heater-Cathode Voltage		±360 max	volts

* Without panel lamp.

** With No.40 or No.47 panel lamp.

Half-Wave Rectifier

MAXIMUM RATINGS (Design-Maximum Values)

Peak Inverse Plate Voltage		360		volts
Peak Plate Current		660		mA
Average Output Current:				
With Panel Lamp and {	No Shunting Resistor	66		mA
Shunting Resistor		100		mA
Without Panel Lamp		110		mA
Panel-Lamp-Section Voltage:				
When Panel Lamp Fails		17		volts
AC Plate-Supply Voltage (rms)	117	117	117	117
Filter-Input Capacitor	40	40	40	40
Minimum Total Effective Plate-Supply Impedance	15	15	15	15
Panel-Lamp Shunting Resistor	—	300	150	100
Average Output Current	60	70	80	90

† No.40 or No.47 panel lamp used in circuit given below with capacitor-input filter.

Installation and Application

OPERATION CHARACTERISTICS HALF-WAVE RECTIFIER

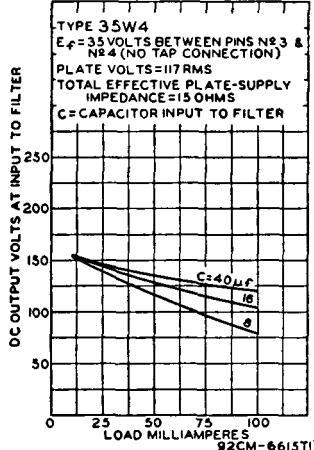

For heater considerations, refer to miniature type 35C5.

With the panel lamp connected as shown in the diagram, the drop across R and all heaters (with panel lamp) should equal 117 volts at 0.15 ampere. The shunting resistor R, is required when dc output current exceeds 60 milliamperes. Values of R, for dc output currents greater than 60 milliamperes are given in tabulated data.

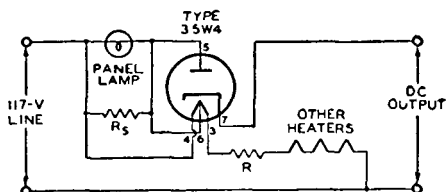

TYPICAL OPERATION WITHOUT PANEL LAMP

AC Plate-Supply Voltage (rms)	117	volts
Filter-Input Capacitor	40	μ F
Minimum Total Effective Plate-Supply Impedance	15	ohms
Average Output Current	100	mA
DC Output Voltage at Input to Filter (Approx.):		
At half-load current (50 mA)	135	volts
At full-load current (100 mA)	120	volts
Voltage Regulation (Approx.):		
Half-load to full-load current	15	volts

MAXIMUM CIRCUIT VALUES

Panel-Lamp Shunting Resistor: [‡]			
For dc output current of {	70 mA	800	ohms
	80 mA	400	ohms
	90 mA	250	ohms

* Required when dc output current is greater than 60 milliamperes.

Refer to chart at end of section.

35Y4

Refer to chart at end of section.

35Z3

Refer to chart at end of section.

35Z4GT

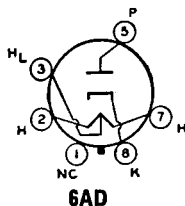

**HALF-WAVE
VACUUM RECTIFIER**

35Z5GT

Glass octal type used in power supply of ac/dc receivers. The heater is provided with a tap for operation of a panel lamp. Outlines section, 13D; requires octal socket. This type may be supplied with pin No.1 omitted. For installation and application considerations, refer to miniature type 35W4.

Heater Voltage (ac/dc):	*	**	
Entire Heater (pins 2 and 7)	35	32	volts
Panel Lamp Section (pins 2 and 3)	7.5	5.5	volts
Heater Current:			
Between Pins 2 and 7	0.15	—	ampere
Between Pins 3 and 7	—	0.15	ampere
Peak Heater-Cathode Voltage		±350 max	volts

* Without panel lamp.

** With No.40 or No.47 panel lamp.

Half-Wave Rectifier

MAXIMUM RATINGS (Design-Center Values)

Peak Inverse Plate Voltage	700	volts
Peak Plate Current	600	mA
Average Output Current:		
With Panel Lamp and { No Shunting Resistor	60	mA
{ Shunting Resistor	90	mA
Without Panel Lamp	100	mA
Panel-Lamp-Section Voltage (rms):		
When Panel Lamp Fails	15	volts

TYPICAL OPERATION WITH PANEL LAMP†

AC Plate-Supply Voltage (rms)	117	117	117	117	235	volts
Filter-Input Capacitor	40	40	40	40	40	μF
Minimum Total Effective Plate-Supply Impedance	15	15	15	15	100	ohms
Panel-Lamp Shunting Resistor	—	300	150	100	—	ohms
Average Output Current	60	70	80	90	60	mA

† No.40 or No.47 panel lamp used in circuit with capacitor-input filter given under type 35W4.

TYPICAL OPERATION WITHOUT PANEL LAMP†

AC Plate-Supply Voltage (rms)	117	235	volts
Filter-Input Capacitor	40	40	μF
Minimum Total Effective Plate-Supply Impedance ..	15	100	ohms
Average Output Current	100	100	mA
DC Output Voltage at Input to Filter (Approx.):			
At half-load current (50 mA)	140	280	volts
At full-load current (100 mA)	120	235	volts
Voltage Regulator (Approx.):			
Half-load to full-load current	20	45	volts

MAXIMUM CIRCUIT VALUES

Panel-Lamp Shunting Resistor*:			
For dc output current of { 70 mA	800	ohms	
{ 80 mA	400	ohms	
{ 90 mA	250	ohms	

* Required when dc output current is greater than 60 milliamperes.

Refer to chart at end of section.

36

Refer to chart at end of section.

**36AM3
36AM3A
36AM3B**

Refer to type 6KD6.

36KD6/40KD6

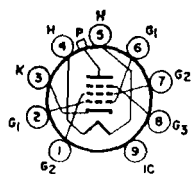

9QL

BEAM POWER TUBE

36MC6

Novar type used for horizontal-deflection amplifier in color television receivers. Outlines section, 18D; requires novar 9-contact socket.

Heater Voltage (ac/dc)	36	volts
Heater Current	0.45	ampere
Heater-Cathode Voltage:		
Peak value	±200 max	volts
Average value	100 max	volts
Direct Interelectrode Capacitances:		
Grid No.1 to Plate	1.0	pF
Grid No.1 to Cathode, Heater, Grid No.2 and Grid No.3	40	pF
Plate to Cathode, Heater, Grid No.2, and Grid No.3	16	pF

Class A₁ Amplifier

CHARACTERISTICS

	Triodet Connection		Pentode Connection		
Plate Voltage	175	—	45	60	175
Peak Positive-Pulse Plate Voltage#	—	5000	—	—	—
Grid-No.3 (Suppressor Grid)	—	30	30	30	30
Grid-No.2 (Screen-Grid) Voltage	175	110	110	110	110
Grid-No.1 (Control-Grid) Voltage	-21	—	0	0	-21
Amplification Factor	4	—	—	—	—
Plate Resistance (Approx.)	—	—	—	—	6000
Transconductance	—	—	—	—	14000
Plate Current	—	—	1100††	750††	125
Grid-No.2 Current	—	—	110††	42††	3.3
Grid-No.1 Voltage for plate current of 1 mA	—	-125	—	—	-40

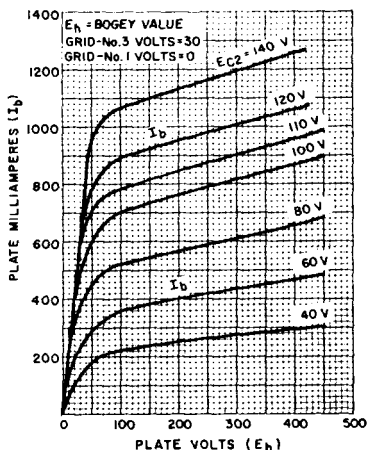
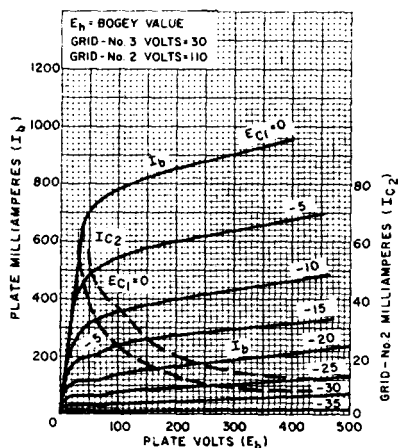

Horizontal-Deflection Amplifier

For operation in a 525-line, 30-frame system

MAXIMUM RATINGS (Design-Maximum Values)

DC Plate Supply Voltage	990	volts
Peak Positive-Pulse Plate Voltage#	7500	volts
Peak Negative-Pulse Plate Voltage	1100	volts
DC Grid-No.3 Voltage	75	volts
DC Grid-No.2 Voltage	250	volts

Peak Negative-Pulse Grid-No.1 Voltage	330	volts
Peak Cathode Current	1400	mA
Average Cathode Current	400	mA
Grid-No.2 Input	5	watts
Plate Dissipation [■]	33	watts
Bulb Temperature (At hottest point)	250	°C

MAXIMUM CIRCUIT VALUES

Grid-No.1-Circuit Resistance:		
For cathode-bias operation	1	megohm
For grid-leak-bias operation	10	megohms
For fixed-bias operation	0.47	megohm

Pulse duration must not exceed 15% of one horizontal scanning cycle (10 microseconds).

† Grid No.2 connected to plate.

†† This value can be measured by a method involving a recurrent waveform such that the maximum ratings of the tube will not be exceeded.

■ In this service, a positive value may be applied to grid No.3 to minimize "snivets" interference; a typical value for this voltage is 30 volts.

■ A bias resistor or other means is required to protect the tube in absence of excitation.

Refer to chart at end of section. **37**

Refer to chart at end of section. **38**

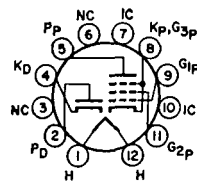

12F5

DIODE—BEAM POWER TUBE 38HE7

Duodecar type used in television receiver applications. The diode unit is used for damper service and the beam power unit for horizontal-deflection amplifier service. Outlines section, 15D; requires duodecar 12-contact socket. Heater: volts (ac/dc), 37.8; amperes, 0.45; warm-up time, 11 seconds; maximum heater-cathode volts, ±200 peak, 100 average.

Beam Power Unit As Class A₁ Amplifier

	Pentode Connection			Triode**	
	5000	50	130	130	volts
Plate Voltage	5000	50	130	130	volts
Grid-No.2 (Screen-Grid) Voltage	130	130	130	130	volts
Grid-No.1 (Control-Grid) Voltage	—	0	—22	—22	volts
Plate Resistance (Approx.)	—	—	6200	—	ohms
Transconductance	—	—	8800	—	μmhos
Plate Current	—	450	60	—	mA
Grid-No.2 Current	—	40	2.8	—	mA
Grid-No.1 Voltage (Approx.) for plate current of 1 mA	—80	—	—39	—	volts
Amplification Factor	—	—	—	4.2	

** Grid No.2 tied to plate.

Beam Power Unit as Horizontal-Deflection Amplifier

For operation in a 525-line, 30-frame system

MAXIMUM RATINGS (Design-Maximum Ratings)

Plate Voltage	500	volts
Peak Positive-Pulse Plate Voltage#	5000	volts
Peak Negative-Pulse Plate Voltage	0	volts
Grid-No.2 Voltage	150	volts
DC Grid-No.1 Voltage, Negative-bias value	55	volts
Peak Negative-Pulse Grid-No.1 Voltage	330	volts
Average Cathode Current	230	mA
Peak Cathode Current	800	mA
Plate Dissipation†	10	watts
Grid-No.2 Input	3.5	watts

MAXIMUM CIRCUIT VALUE

Grid-No.1-Circuit Resistance	1	megohm
------------------------------------	---	--------

† A bias resistor or other means is required to protect the tube in absence of excitation.

Damper Service—Diode Unit

For operation in a 525-line, 30-frame system

MAXIMUM RATINGS (Design-Maximum Values)

Peak Inverse Plate Voltage#	4200	volts
Peak Plate Current	1200	mA
Average Plate Current	200	mA
Heater-Cathode Voltage:		
Peak value	+200 —4200	volts
Average value	+100 —500	volts
Bulb Temperature (at hottest point)	200	°C

CHARACTERISTICS, Instantaneous Value

Tube Voltage Drop for plate current of 350 mA	21	volts
-----------------------------------------------	----	-------

Pulse duration must not exceed 15% of a horizontal scanning cycle (10 microseconds).

38HK7

53HK7

DIODE—BEAM POWER TUBE

Duodecar type used in television receiver applications. The diode unit is used for damper service and the beam power unit for horizontal-deflection amplifier service. Outlines section, 15D; requires duodecar 12-contact socket. Type 53HK7 is identical with 38HK7 except for heater ratings.

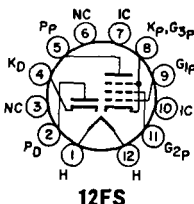

Heater Voltage (ac/dc)	38HK7	53HK7	
Heater Current	37.8	53.2	volts
Heater Warm-up Time (Average)	0.45	0.315	ampere seconds
Heater-Cathode Voltage:	11	11	
Peak value	±200 max	±200 max	volt
Average value	100 max	100 max	volts
Direct Interelectrode Capacitances (Approx.):			
Diode Unit:			
Plate to Cathode and Heater		10	pF
Cathode to Plate and Heater		9	pF
Heater to Cathode		2	pF
Beam Power Unit:			
Grid No.1 to Plate		0.38	pF
Grid No.1 to Cathode, Heater, Grid No.2, and Grid No.3		19	pF
Plate to Cathode, Heater, Grid No.2, and Grid No.3		8	pF

Beam Power Unit as Class A₁ Amplifier

CHARACTERISTICS	Triode**		Pentode Connection		
	Connection				
Plate Voltage	130	3500	50	130	volts
Grid-No.2 (Screen-Grid) Voltage	130	130	130	130	volts
Grid-No.1 (Control-Grid) Voltage	-22	—	0	-22	volts
Amplification Factor	4.2	—	—	—	
Plate Resistance	—	—	—	6200	ohms
Transconductance	—	—	—	8800	μmhos
Plate Current	—	—	450	60	mA
Grid-No.2 Current	—	—	40	2.8	mA
Grid-No.1 Voltage (Approx.) for plate current of 1 mA	—	-66	—	-39	volts

MAXIMUM CIRCUIT VALUE

Grid-No.1-Circuit Resistance	1	megohm
------------------------------	---	--------

** Grid No.2 tied to plate.

Beam Power Unit as Horizontal-Deflection Amplifier

For operation in a 525-line, 30-frame system

MAXIMUM RATINGS (Design-Maximum Values)

Plate Voltage	500	volts
Peak Positive-Pulse Plate Voltage	5000	volts
Peak Negative-Pulse Plate Voltage	0	volts
Grid-No.2 Voltage	150	volts
DC Grid-No.1 Voltage, Negative-bias value	55	volts
Peak Negative-Pulse Grid-No.1 Voltage	330	volts
Average Cathode Current	230	mA
Peak Cathode Current	800	mA
Plate Dissipation†	10	watts
Grid-No.2 Input	3.5	watts

MAXIMUM CIRCUIT VALUE

Grid-No.1-Circuit Resistance	1	megohm
------------------------------------	---	--------

† A bias resistor or other means is required to protect the tube in absence of excitation.

Damper Service—Diode Unit

For operation in a 525-line, 30-frame system

MAXIMUM RATINGS (Design-Maximum Values)

Peak Inverse Plate Voltage#	4200	volts
Peak Plate Current	1200	mA
Average Plate Current	200	mA
Heater-Cathode Voltage:		
Peak value	+200	—3700
Average value	+100	—500
Bulb Temperature (At hottest point)	200	°C

CHARACTERISTIC, Instantaneous Value

Tube Voltage Drop for plate current of 350 mA	16	volts
-----------------------------------------------------	----	-------

Pulse duration must not exceed 15% of a horizontal scanning cycle (10 microseconds).

Refer to chart at end of section.	39/44
Refer to chart at end of section.	40
Refer to chart at end of section.	40KD6
For replacement use type 36KD6/40KD6.	
Refer to type 6KG6A/EL509.	40KG6A/PL509
Refer to chart at end of section.	41
Refer to chart at end of section.	42
Refer to chart at end of section.	42EC4A/PY500
Refer to type 6KN6.	42KN6
Refer to chart at end of section.	43
Refer to chart at end of section.	45
Refer to chart at end of section.	45Z3
Refer to chart at end of section.	45Z5GT
Refer to chart at end of section.	46
Refer to chart at end of section.	47
Refer to chart at end of section.	48
Refer to chart at end of section.	49
Refer to chart at end of section.	50
Refer to chart at end of section.	50A5
Refer to chart at end of section.	50B5
Refer to type 6BM8/ECL82.	50BM8/UCL82

50C5

25C5

BEAM POWER TUBE

Miniature type used in output stage of compact, ac/dc radio receivers. Outlines section, 5D; requires miniature 7-contact socket. This tube, like other power-handling tubes, should be adequately ventilated. Within its maximum ratings, type 50C5 is equivalent in performance to glass octal type 50L6GT. Type 25C5 is identical with type 50C5 except for heater ratings.

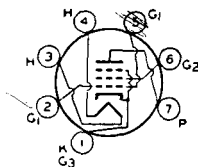

7CV

Heater Voltage (ac/dc)	25C5 25	50C5 50	volts
Heater Current	0.3	0.15	ampere
Heater-Cathode Voltage:			
Peak value	±200 max	±200 max	volts
Average value	100 max	100 max	volts
Direct Interelectrode Capacitances (Approx.):			
Grid No.1 to Plate		0.6	pF
Grid No.1 to Cathode, Heater, Grid No.2, and Grid No.3		13	pF
Plate to Cathode, Heater, Grid No.2, and Grid No.3		8.5	pF

Class A₁ Amplifier

MAXIMUM RATINGS (Design-Maximum Values)

Plate Voltage	150	volts
Grid-No.2 (Screen-Grid) Voltage	130	volts
Grid-No.1 (Control-Grid) Voltage, Positive-bias value	0	volts
Plate Dissipation	7	watts
Grid-No.2 Input	1.4	watts
Bulb Temperature (At hottest point)	220	°C

TYPICAL OPERATION

Plate Voltage	120	volts
Grid-No.2 Voltage	110	volts
Grid-No.1 (Control-Grid) Voltage	-8	volts

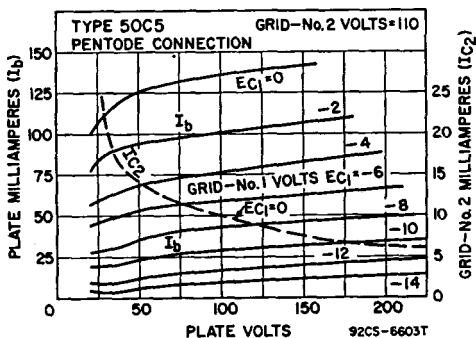

Peak AF Grid-No.1 Voltage	8	volts
Zero-Signal Plate Current	49	mA
Maximum-Signal Plate Current	50	mA
Zero-Signal Grid-No.2 Current	4	mA
Maximum-Signal Grid-No.2 Current	8.5	mA
Plate Resistance (Approx.)	10000	ohms
Transconductance	7500	μmbos
Load Resistance	2500	ohms
Total Harmonic Distortion	10	per cent
Maximum-Signal Power Output	2.3	watts

MAXIMUM CIRCUIT VALUES

Grid-No.1-Circuit Resistance:		
For fixed-bias operation	0.1	megohm
For cathode-bias operation	0.5	megohm

Installation and Application

The 50-volt heater is designed to operate under the normal conditions of line voltage variation without materially affecting the performance or serviceability of the 50C5. For operation of the 50C5 in series with other types having 0.15-ampere rating, the current in the heater circuit should be adjusted to 0.15 ampere for the normal supply voltage.

In a series-heater circuit of the "dc power line" type employing several 0.15-ampere types and one or two 50C5s, the heater(s) of the 50C5(s) should be placed on the positive side of the line. Under these conditions, heater-cathode voltage of the 50C5 must not exceed the value given under maximum ratings. In a series-heater circuit of the "universal" type employing rectifier tube 35W4, one or two 50C5s, and several 0.15-ampere types, it is recommended that the heater(s) of the 50C5(s) be placed in the circuit so that the higher values of heater-cathode bias will be impressed on the 50C5(s) rather than on the other 0.15-ampere types. This is accomplished by arranging the 50C5(s) on the side of the supply line which is connected to the cathode of the rectifier, i.e., the positive terminal of the rectified voltage supply. Between this side of the line and the 50C5(s), any necessary auxiliary resistance and the heater of the 35W4 are connected in series.

As a power amplifier (class A₁), the 50C5 is recommended for use either singly or in push-pull combination in the power-output stage of "ac/dc" receivers. The operating values shown under typical operation have been determined on the basis that grid-No. 1 current does not flow during any part of the input cycle.

Refer to chart at end of section.	50C6G
Refer to chart at end of section.	50DC4
Refer to type 6EH5.	50EH5
Refer to chart at end of section.	50FE5
Refer to chart at end of section.	50FK5
Refer to type 33GY7A.	50GY7A
Refer to chart at end of section	50HC6

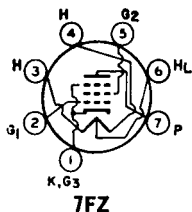

POWER PENTODE

50HK6

Miniature type used in audio-frequency power-output stage of radio receivers. Outlines section, 5D; requires miniature 7-contact socket. The heater is provided with a tap for operation of a panel lamp. Heater: volts (ac/dc), 50; amperes, 0.15; tap volts (without panel lamp), 7; maximum heater-cathode volts, ± 200 peak, 100 average.

Class A₁ Amplifier

MAXIMUM RATINGS (Design-Maximum Values)

Plate Voltage	150	volts
Grid-No.2 (Screen-Grid) Voltage	130	volts
Plate Dissipation	5.5	watts
Grid-No.2 Input	1.1	watts
RMS Heater-Tap Voltage When Panel Lamp Fails	14	volts

TYPICAL OPERATION AND CHARACTERISTICS

Plate Voltage	110	volts
Grid-No.2 Voltage	110	volts
Grid-No.1 (Control-Grid) Voltage	-7.5	volts
Peak AF Grid-No.1 Voltage	7.5	volts
Zero-Signal Plate Current	49	mA
Maximum-Signal Plate Current	50	mA
Zero-Signal Grid-No.2 Current	4	mA
Maximum-Signal Grid-No.2 Current	8.5	mA
Plate Resistance (Approx.)	10000	ohms
Transconductance	7500	μ hos
Load Resistance	2500	ohms
Total Harmonic Distortion (Approx.)	9	per cent
Maximum-Signal Power Output	1.9	watts

MAXIMUM CIRCUIT VALUES

Grid-No.1-Circuit Resistance:		
For fixed-bias operation	0.1	megohm
For cathode-bias operation	0.5	megohm

50JY6

Refer to chart at end of section.

50L6GT

25L6GT

BEAM POWER TUBE

Glass octal type used in output stage of ac/dc radio receivers. Outlines section, 13D; requires octal socket. This type may be supplied with pin No.1 omitted. Refer to miniature type 50C5 for installation and application information. Type 25L6GT is identical with type 50L6GT except for heater ratings.

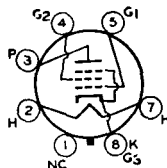

7AC

	25L6GT	50L6GT	
Heater Voltage (ac/dc)	25	50	volts
Heater Current	0.3	0.15	ampere
Peak Heater-Cathode Voltage	± 90 max	± 90 max	volts
Direct Interelectrode Capacitances (Approx.):			
Grid No.1 to Plate		0.6	pF
Grid No.1 to Cathode, Heater, Grid No.2, and Grid No.3		15	pF
Plate to Cathode, Heater, Grid No.2, and Grid No.3		9.5	pF

Class A₁ Amplifier

MAXIMUM RATINGS (Design-Center Values)

Plate Voltage	200	volts
Grid-No.2 (Screen-Grid) Voltage	125	volts
Plate Dissipation	10	watts
Grid-No.2 Input	1.25	watts

TYPICAL OPERATION

	Fixed Bias	Cathode Bias	
Plate Supply Voltage	110	200	volts
Grid-No.2 Supply Voltage	110	125	volts
Grid-No.1 (Control-Grid) Voltage	-7.5	—	volts
Peak AF Grid-No.1 Voltage	7.5	8.0	volts
Cathode-Bias Resistor	—	180	ohms
Zero-Signal Plate Current	49	46	mA
Maximum-Signal Plate Current	50	47	mA
Zero-Signal Grid-No.2 Current	4	2.2	mA
Maximum-Signal Grid-No.2 Current	10	8.5	mA
Plate Resistance (Approx.)	13000	28000	ohms
Transconductance	3000	8000	μ hos
Load Resistance	2000	4000	ohms
Total Harmonic Distortion	10	10	per cent
Maximum-Signal Power Output	2.1	3.8	watts

50X6

Refer to chart at end of section.

50Y6GT

Refer to chart at end of section.

Refer to chart at end of section.	50Y7GT
Refer to chart at end of section.	50Z7G
Refer to chart at end of section.	53
Refer to type 38HK7.	53HK7
Refer to type 12FX5.	60FX5
Refer to chart at end of section.	70L7GT
Refer to chart at end of section.	75
Refer to chart at end of section.	78
Refer to chart at end of section.	80
Refer to chart at end of section.	83
Refer to chart at end of section.	84/6Z4
Refer to chart at end of section.	117L7GT/M7GT
Refer to chart at end of section.	117N7GT
Refer to chart at end of section.	117P7GT
Refer to chart at end of section.	117Z3
Refer to chart at end of section.	117Z4GT
Refer to chart at end of section.	117Z6GT
Refer to chart at end of section.	407A
Refer to chart at end of section.	408A
Refer to chart at end of section.	884
Refer to chart at end of section.	955
Refer to chart at end of section.	959
Refer to chart at end of section.	991
Refer to chart at end of section.	1612
Refer to chart at end of section.	1614
Refer to chart at end of section.	1619
Refer to chart at end of section.	1620
Refer to chart at end of section.	1621
Refer to chart at end of section.	1622
Refer to chart at end of section.	1629
Refer to chart at end of section.	1635

2050**INDUSTRIAL
TYPE****GAS THYRATRON**

Glass octal type gas tetrode thyatron for use in relay and grid-controlled-rectifier service. Outlines section, 22; requires octal socket. For maximum ratings and typical operating conditions refer to type 2050A.

	Min.	Av.	Max.	
Heater Voltage (ac/dc)	5.7	6.3	6.9	volts
Heater Current	0.54	0.60	0.66	ampere
Cathode:				
Heating Time, prior to tube conduction	10	—	—	sec
Direct Interelectrode Capacitances (Approx.):				
Grid No. 1 to Anode			0.26	pF
Input			4.2	pF
Output			3.6	pF

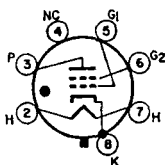
**6BS****2050A****INDUSTRIAL
TYPE****GAS THYRATRON**

Glass octal type gas tetrode thyatron for use in relay and grid-controlled-rectifier service. Outlines section, 13C; requires octal socket.

Heater Voltage (ac/dc)	6.3 ±10%	volts
Heater Current	0.6	ampere
Peak Heater-Cathode Voltage:		
Heater negative with respect to cathode	100 max	volts
Heater positive with respect to cathode	25 max	volts
Cathode:		
Minimum heating time prior to tube conduction	10	seconds
Direct Interelectrode Capacitances (Approx.):		
Grid No. 1 to anode	0.15	pF
Grid No. 1 to cathode and grid No. 2	2.2	pF
Ionization Time (Approx.):		
For dc anode volts = 100, grid-No. 1 volts (square-wave pulse) = 50, peak anode amperes during conduction = 1	0.5	μs
Deionization Time (Approx.):		
With dc anode volts = 125, grid-No. 1 volts = -250, grid-No. 1 resistor (ohms) = 1000, dc anode amperes = 0.1	50	μs
With dc anode volts = 125, grid-No. 1 volts = -10, grid-No. 1 resistor (ohms) = 1000, dc anode amperes = 0.1	100	μs
Maximum Critical Grid-No. 1 Current for dc anode supply volts (rms) = 460, average anode amperes = 0.1	0.5	μA
Anode Voltage Drop (Approx.)	8	volts
Grid-No. 1 Control Ratio (Approx.) for grid-No. 1 resistor (ohms) = 0, grid No. 2 connected to cathode at socket	250	
Grid-No. 2 Control Ratio (Approx.) for grid-No. 1 resistor (ohms) = 0, grid-No. 2 resistor (ohms) = 0, grid No. 1 connected to cathode at socket	800	

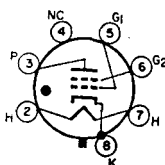
**6BS****Relay and Grid-Controlled Rectifier Service**

For anode supply frequency of 60 Hz

MAXIMUM RATINGS (Absolute-Maximum Values)

Peak Anode Voltage:			
Forward	180	650	volts
Inverse	360	1300	volts
Grid-No. 2 (Shield-Grid) Voltage:			
Peak, before tube conduction	-100	-100	volts
Average*, during tube conduction	-10	-10	volts
Grid-No. 1 (Control-Grid) Voltage:			
Peak, before tube conduction	-250	-250	volts
Average*, during tube conduction	-10	-10	volts
Cathode Current:			
Peak	1	1	ampere
Average*	0.2	0.1	ampere
Fault, for duration of 0.1 second maximum	10	10	ampere

Grid-No. 2 Current:			
Average* +0.01	+0.01	ampere
Grid-No. 1 Current:			
Average* +0.01	+0.01	ampere
Ambient-Temperature Range -75 to +90	-75 to +90	°C

TYPICAL OPERATION FOR RELAY SERVICE

RMS Anode Voltage 117	400	volts
Grid No. 2	Connected to cathode at socket	volts
RMS Grid-No. 1 Bias Voltage [▲] 5	—	volts
DC Grid-No. 1 Voltage —	-6	volts
Peak Grid-No. 1 Signal Voltage 5	6	volts
Grid-No. 1 Circuit Resistance 1	1	megohm
Anode-Circuit Resistance [†] 1200	2000	ohms

MAXIMUM CIRCUIT VALUES

Grid-No. 1-Circuit Resistance:		
For average anode current below 0.1 ampere 10	megohms
For average anode current above 0.1 ampere 2	megohms

* Averaged over any interval of 30 seconds maximum.

[▲] Approximately 180° out of phase with the anode voltage.

[†] Sufficient resistance, including the tube load, must be used under any conditions of operation to prevent exceeding the current ratings.

Operating Considerations

The heater is designed to operate on either ac or dc at 6.3 volts. Regardless of the heater-voltage supply used the heater voltage must never be allowed to deviate from its rated range. Heater operation outside of this voltage range will impair tube performance and may cause tube failure. Low heater voltage causes low cathode temperature with resultant cathode sputtering and consequent destruction of the cathode; high heater voltage causes high cathode temperature with resultant heating of the grid and consequent grid emission which produces unpredictable shifts in the critical grid-No. 1 voltage for conduction.

The cathode should be allowed to reach normal operating temperature before anode current is drawn. The delay period should not be less than 10 seconds after application of heater voltage. Unless this recommendation is followed, the cathode will be damaged.

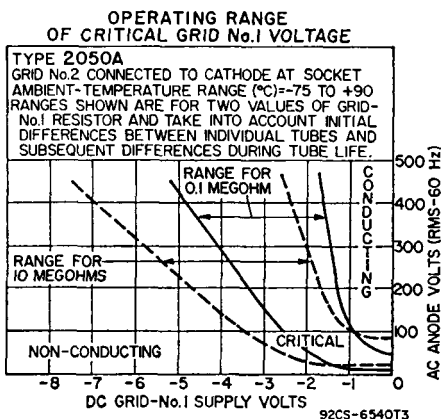

The shield grid (grid No. 2) is normally connected to the cathode at socket. It may, however, be used as a control electrode because the control characteristic of grid No. 1 may be shifted by varying the potential of grid

No. 2. As grid No. 2 is made negative, the grid-No. 1 characteristic is shifted in the positive direction. The use of grid No. 2 as the control electrode (with grid No. 1 connected to cathode at socket) has the advantage of increased sensitivity but consideration must be given to the higher pre-conduction current, higher capacitance to anode, and less stability of operation.

A grid-No. 1 resistor having a value as high as 10 megohms to give circuit sensitivity can be used with the 2050-A because its control-grid current is very low. However, when a high value of grid resistor is used, care should be taken to keep the tube base and socket clean and dry in order to make the effect of leakage currents between the control-grid base pin and anode base pin very small.

Sufficient anode-circuit resistance, including the tube load, must be used under any conditions of operation to prevent exceeding the current ratings of the tube.

2076/5R4GB

Refer to chart at end of section.

2076/5R4GYB

For replacement use type 2076/5R4GB.

2081/6AW8A

Refer to chart at end of section.

2082/12AY7

Refer to chart at end of section.

5636

Refer to chart at end of section.

5639

Refer to chart at end of section.

5642

Refer to chart at end of section.

5651A

INDUSTRIAL
TYPE

VOLTAGE-REFERENCE TUBE

Miniature type cold-cathode, glow-discharge voltage-reference tube for use in dc power supplies. Outlines reference tube, 5C; requires miniature 7-contact socket.

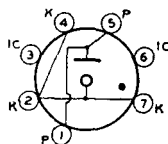

5B0

MAXIMUM RATINGS (Absolute-Maximum Values)

DC Operating Current (Continuous)	3.5	mA
DC Operating Current (Continuous)	1.5	mA
Ambient Temperature Range	-55 to 90	°C

CHARACTERISTICS AND OPERATION RANGE VALUES

	Min.	Av.	Max.	
DC Starting Voltage	—	107	115*	volts
DC Operating Voltage (Variation from tube to tube):				
At 1.5 mA	83	85	87	volts
At 2.5 mA	83.5	85.5	87.5	volts
At 3.5 mA	84.5	86.5	88.5	volts
Regulation (1.5 mA to 3.5 mA)	—	—	3	volts
Temperature coefficient of Operating Voltage (over ambient temperature range of -55 to 90°C)	—	-4	—	mV/°C
Percentage Variation of Operating Voltage:†				
During first 300 hours of life‡	—	—	0.1	per cent
During subsequent 1000 hours of life	—	—	0.1	per cent
Short-term (100 hours)				
Variation of Operating Voltage after first 300 hours of life§	—	—	0.05	per cent
Instantaneous Voltage				
Fluctuation (Voltage jump)¶	—	—	0.1	volt

CIRCUIT VALUES

Shunt Capacitor	—	—	0.02	μF
Series Resistor	—	—	‡	

- * A dc supply voltage of 115 volts minimum should be provided to insure "starting" throughout tube life.
- DC operating current = 2.5 mA.
- After initial 3-minute warm-up period.
- † Defined as the maximum instantaneous voltage fluctuation at any current level within the operating current range.
- ‡ A series resistor must always be used with the 5651A. The resistance value must be chosen so that (1) the maximum current rating of 3.5 mA is not exceeded at the highest anode-supply voltage employed, and (2) the minimum current rating of 1.5 mA is always exceeded when the anode-supply voltage is at its lowest value.

Installation and Application

Make no connection to pins 3 and 6. Any potentials applied to these pins may cause erratic tube performance. The three pin terminals for the cathode (pins 2, 4, and 7) and the two for the anode (pins 1 and 5) offer the equipment designer several different possibilities for connection of the 5651A. Any pair of interconnected pins can be used as a jumper connection to a circuit common to either the cathode or to the anode. The use of such a jumper connection provides a means for opening the circuit to protect circuit components when the 5651A is removed from its socket. Under no circumstances should the current through any pair of interconnected pins exceed one ampere.

If the load for the regulated power supply is disconnected either directly or by removing the 5651A from its socket, the rectifier capacitors will charge to the rectifier peak voltage. It is important, therefore, that these capacitors be rated to withstand such voltage.

A warm-up period of 3 minutes should be allowed each time the equipment is turned on to insure minimum voltage drift of the 5651A.

When a shunt capacitor is used with the 5651A, its value should be limited to 0.02 μ F. A large value of capacitance may cause the tube to oscillate and thus give unstable performance.

Shielding should be utilized for the 5651A to insure maximum stability when the tube is operated in the presence of strong rf or magnetic fields.

Refer to chart at end of section.

5651WA

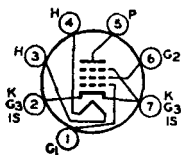

7BD

SHARP-CUTOFF PENTODE

5654

INDUSTRIAL TYPE

Miniature type sharp-cutoff pentode used in RF and IF broad-band applications at frequencies up to 400 mHz. Outlines section, 5B; requires miniature 7-contact socket.

Heater Voltage (ac/dc)	6.3 \pm 10%	volts
Heater Current	0.175	ampere
Heater-Cathode Voltage:		
Peak value	\pm 100	volts
Direct Interelectrode Capacitances: [▲]		
Grid No.1 to Plate	0.020 max.	pF
Input	4.0	pF
Output	2.85	pF

▲ With external shield.

Class A₁ Amplifier

MAXIMUM RATINGS (Absolute-Maximum Values)

Plate Voltage	200	volts
Grid-No.2 (Screen) Voltage	155	volts

Plate Dissipation	1.85	watts
Grid-No.2 Input	0.55	watt
Cathode Current	20	mA

TYPICAL OPERATION AND CHARACTERISTICS

Plate Voltage	120	180	volts
Grid-No.2 Voltage	120	120	volts
Cathode-Bias Resistor	180	180	ohms
Plate Resistance (Approx.)	0.30	0.50	megohm
Transconductance	5000	5100	μ mhos
Plate Current	7.5	7.7	mA
Grid-No.2 Current	2.5	2.4	mA
Grid-No.1 Voltage (Approx.) for plate current of 10 μ A ..	-8.5	-8.5	volts

MAXIMUM CIRCUIT VALUE

Grid-No.1-Circuit Resistance	0.5	megohm
------------------------------------	-----	--------

Special Ratings & Performance Data**SHOCK RATING**

Impact Acceleration	500 max.	g
---------------------------	----------	---

FATIGUE RATING

Vibrational Acceleration	2.5 max.	g
--------------------------------	----------	---

HEATER CYCLING LIFE PERFORMANCE

Cycles of Intermittent Operation	2000 min.	cycles
----------------------------------------	-----------	--------

5654W

Refer to chart at end of section.

**5654/6AK5W/
6096**

Refer to chart at end of section.

5663

Refer to chart at end of section.

5670

Refer to chart at end of section.

5670WA

Refer to chart at end of section.

5672

Refer to chart at end of section.

5678

Refer to chart at end of section.

5686

Refer to chart at end of section.

5687

Refer to chart at end of section.

5691

Refer to chart at end of section.

5692

Refer to chart at end of section.

5693

Refer to chart at end of section.

5696**INDUSTRIAL
TYPE****THYRATRON**

Miniature type gas-tetrode thyatron for use in counter-circuit relay applications. Outlines section, 5B; requires miniature 7-contact socket.

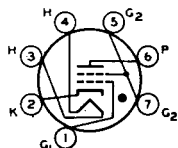
**7BN**

Heater Voltage (ac/dc)	6.3	volts
Heater Current	0.150	ampere
Heater-Cathode Voltage: Peak	+25, -100	volts

Cathode:		
Minimum Heating Time, prior to tube conduction	10	seconds
Direct Interelectrode Capacitances (Approx.):		
Grid No.1 to Anode	0.03	pF
Input	1.8	pF
Output	0.54	pF
Ionization Time (Approx.):		
For conditions: dc anode volts = 100; grid-No.1 square-pulse volts = +50; peak cathode amperes during conduction = 0.150	0.5	μs
Deionization Time (Approx.):		
For conditions: dc anode volts = 500; grid-No.1 volts = -100; grid-No.1 resistor (ohms) = 1000; dc cathode amperes = 0.025	25	μs
For conditions: dc anode volts = 500; grid-No.1 volts = -13; grid-No.1 resistor (ohms) = 1000; dc cathode amperes = 0.025	40	μs
Maximum Critical Grid-No.1 Current, with ac anode-supply volts (rms) = 350, and average cathode amperes = 0.025	0.5	μA
Anode Voltage Drop (Approx.)	10	volts
Grid-No.1 Control Ratio (Approx.) with grid-No.1 resistor (meg-ohms) = 0; grid-No.2 volts = 0	250	
Grid-No.2 Control Ratio (Approx.) with grid-No.1 volts = 0, grid-No.2 resistor (ohms) = 0	15	

Relay and Grid-Controlled Rectifier Service

MAXIMUM RATINGS (Absolute-Maximum Values)

Peak Anode Voltage:		
Forward	500	volts
Inverse	500	volts
Grid-No.2 (Shield-Grid) Voltage:		
Peak, before anode conduction	-50	volts
Average, during anode conduction [■]	-10	volts
Grid-No.1 (Control-Grid) Voltage:		
Peak, before anode conduction	-100	volts
Average, during anode conduction [■]	-10	volts
Cathode Current:		
Peak	100	mA
Average [■]	25	mA
Surge, for duration of 0.1 sec. max.	2	amperes
Grid-No.2 Current:		
Average [■]	5	mA
Grid-No.1 Current:		
Average [■]	5	mA
Ambient Temperature Range	-55 to +90	°C

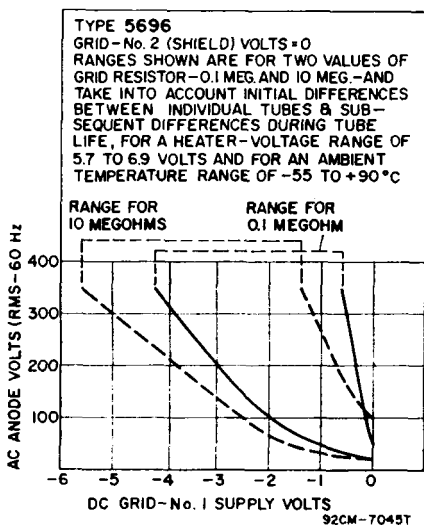

TYPICAL OPERATING CONDITIONS FOR RELAY SERVICE

RMS Anode Voltage	117	volts
Grid No.2	Connected to cathode at socket	
RMS Grid-No.1 Bias Voltage [□]	5	volts
Peak Grid-No.1 Signal Voltage	5	volts
Grid-No.1-Circuit Resistance	0.1	megohm
Anode-Circuit Resistance#	5000	ohms

MAXIMUM CIRCUIT VALUE

Grid-No.1-Circuit Resistance	10	megohms
------------------------------------	----	---------

■ Averaged over any interval of 30 sec. max.

□ Approximately 180° out of phase with the anode voltage.

Sufficient resistance, including the tube load, must be used under any conditions of operation to prevent exceeding the current ratings.

5696A Refer to chart at end of section.

5718 Refer to chart at end of section.

5719 Refer to chart at end of section.

5725 Refer to chart at end of section.

5725/6A56W Refer to chart at end of section.

5726 Refer to chart at end of section.

5726/6A15W Refer to chart at end of section.

**5726/6A15W/
6097** Refer to chart at end of section.

5727INDUSTRIAL
TYPE

GAS THYRATRON

Miniature type "Premium" gas-tetrode thyatron for use in relay, grid-controlled rectifier and pulse-modulator applications. Outlines section, 5C; requires miniature 7-contact socket.

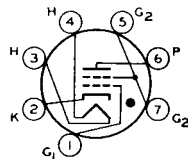
**7BN**

Heater Voltage (ac/dc)	6.3 ±10%	volts
Heater Current	0.6	ampere
Cathode:		
Minimum heating time prior to tube conduction	20	seconds
Direct Interelectrode Capacitances (Approx.):		
Grid No.1 to anode	0.026	pF
Grid No.1 to cathode, grid No.2, and heater	2.4	pF
Anode to cathode, grid No.2, and heater	1.6	pF
Ionization Time (Approx.):		
For dc anode volts = 100, grid-No.1 volts (square-wave pulse) = 50, peak anode amperes during conduction = 0.5	0.5	μs
Deionization Time (Approx.):		
For dc anode volts = 125, dc anode amperes = 0.1, grid-No.1 resistor (ohms) = 1000, and grid-No.1 volts = -100	35	μs
For dc anode volts = 125, dc anode amperes = 0.1, grid-No.1 resistor (ohms) = 1000, and grid-No.1 volts = -100	75	μs
Maximum Critical Grid-No.1 Current:		
For anode-supply volts (rms) = 460, and average anode amperes = 0.1	0.5	μA
Anode Voltage Drop (Approx.)	8	volts
Grid-No.1 Control Ratio (Approx.) with grid-No.1 resistor (megohms) = 0, grid-No.2 volts = 0	250	
Grid-No.2 Control Ratio (Approx.) with grid-No.1 resistor (megohms) = 0, grid-No.2 resistor (megohms) = 0, grid-No.1 volts = 0	1000	

Relay and Grid-Controlled Rectifier Service

MAXIMUM RATINGS (Absolute-Maximum Values)

For anode-supply frequency of 60 Hz

Peak Anode Voltage:			
Forward	650		volts
Inverse	1300		volts
Grid-No.2 (Shield-Grid) Voltage:			
Peak, before tube conduction	-100		volts
Average [■] , during tube conduction	-10		volts
Grid-No.1 (Control-Grid) Voltage:			
Peak, before tube conduction	-100		volts
Average [■] , during tube conduction	-10		volts
Cathode Current:			
Peak	0.5		ampere
Average [■]	0.1		ampere
Fault, for duration of 0.1 second max.	10		amperes
Grid-No.2 Current:			
Average [■]	10		mA
Grid-No.1 Current:			
Average [■]	10		mA
Heater-Cathode Voltage:			
Peak	+25, -100		volts
Bulb Temperature (At hottest point on bulb surface)	150		°C
Ambient Temperature	-75		°C

TYPICAL OPERATION FOR RELAY SERVICE

RMS Anode Voltage	117	400	volts
Grid-No.2 Voltage	0	0	volts
RMS Grid-No.1 Bias Voltage [□]	5	—	volts
DC Grid-No.1 Bias Voltage	—	-6	volts
Peak Grid-No.1 Signal Voltage	5	6	volts
Grid-No.1-Circuit Resistance	1	1	megohm
Anode-Circuit Resistance [#]	1200	2000	ohms

MAXIMUM CIRCUIT VALUE

Grid-No.1-Circuit Resistance	10	megohms
------------------------------	----	---------

Pulse-Modulated Service

For rectangular-wave shapes, duty cycle of 0.001 max., pulse duration of 5 μs max., and pulse-repetition rate of 500 pps max.

MAXIMUM RATINGS (Absolute-Maximum Values)

Peak Anode Voltage:			
Forward	500		volts
Inverse	100		volts
Grid-No.2 (Shield-Grid) Voltage:			
Peak, before tube conduction	-50		volts
Average, during tube conduction	-10		volts
Grid-No.1 (Control-Grid) Voltage:			
Peak, before tube conduction	-100		volts
Average, during tube conduction	-10		volts
Cathode Current:			
Peak	10		amperes
Average	10		mA
Rate of change	100		A/μs
Peak Grid-No.2 Current	20		mA
Peak Grid-No.1 Current	20		mA
Heater-Cathode Voltage:			
Peak	±0		volt
Bulb Temperature (At hottest point on bulb surface)	150		°C
Ambient Temperature	-75		°C

MAXIMUM CIRCUIT VALUES

Grid-No.1-Circuit Resistance	0.5	megohm
Grid-No.2-Circuit Resistance	{ 25000 max. 2000 min.	ohms

* For pulse-modulator service, tolerance is +10%, -5%.

■ Averaged over any interval of 30 seconds maximum.

□ Approximately 180° out of phase with the anode voltage.

Sufficient resistance, including the tube load, must be used under any conditions of operation to prevent exceeding the current ratings.

Special Ratings and Performance Data

SHOCK RATING

Impact Acceleration 750 max. g

FATIGUE RATING

Vibrational Acceleration 2.5 max. g

HEATER-CYCLING LIFE PERFORMANCE

Cycles of Intermittent Operation 2000 min. cycles

Operating Considerations

Sufficient anode-circuit resistance, including the tube load, must be used under any conditions of operation to prevent exceeding the current ratings of the tube.

Curve shown under type 2D21 also applies to type 5727

5734 Refer to chart at end of section.

5749 Refer to chart at end of section.

5749/6BA6W Refer to chart at end of section.

5750 Refer to chart at end of section.

5751INDUSTRIAL
TYPE

HIGH-MU TWIN TRIODE

Miniature type "Premium" high-mu twin triode used as a phase inverter and as a high gain amplifier in industrial control devices. Outlines section, 6B; requires miniature 9-contact socket.

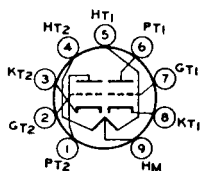

9A

Heater Arrangement:	Series	Parallel	
Heater Voltage (ac/dc)	12.6 ±10%	6.3 ±10%	volts
Heater Current	0.175	0.350	ampere
Heater-Cathode Voltage:			
Peak		±100 max.	volts

Class A₁ Amplifier (Each Unit)

MAXIMUM RATINGS (Design-Maximum Values)

Plate Voltage	330	volts
Grid Voltage:		
Negative-bias value	55	volts
Positive-bias value	0	volt
Plate Dissipation	0.8	watt
Bulb Temperature (At hottest point on bulb surface)	165	°C

CHARACTERISTICS

Plate Voltage	100	250	volts
Grid Voltage	-1	-3	volts
Amplification Factor	70	70	
Plate Resistance	58000	58000	ohms
Transconductance	1200	1200	μmhos
Plate Current	0.9	1.0	mA

Special Ratings & Performance Data

SHOCK RATING

Impact Acceleration 600 max. g

FATIGUE RATING

Vibrational Acceleration 2.5 max. g

LOW-FREQUENCY VIBRATION PERFORMANCE

RMS Output Voltage 100 max. mV

HEATER-CYCLING LIFE PERFORMANCE

Cycles of Intermittent Operation 2000 min. cycles

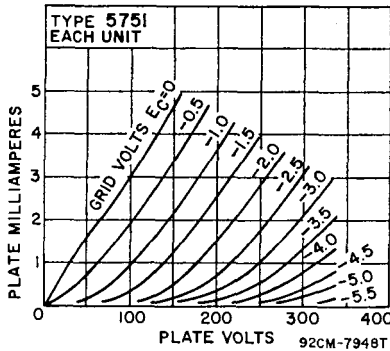

Refer to chart at end of section.

5751WA

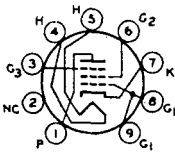

9K

VHF BEAM POWER TUBE

5763

INDUSTRIAL TYPE

Miniature type VHF beam power amplifier for use in low-power mobile transmitters and the low-power stages of larger fixed station transmitters. Outlines section, 6E; requires miniature 9-contact socket.

Heater Voltage (ac/dc)	6.0 ±10%	volts
Heater Current	0.75	ampere
Heater-Cathode Voltage: Peak	±100 max.	volts
Transconductance for plate current of 45 mA	7000	μmhos
Mu-Factor, Grid No.2 to Grid No.1	16	
Direct Interelectrode Capacitances:		
Grid-No.1 to Plate	0.3 max	pF
Input	9.5	pF
Output	4.5	pF

Plate-Modulated RF Power Amplifier—Class C Telephony

Carrier conditions per tube for use with a max. modulation factor of 1.0

CCS● ICAS●●

MAXIMUM RATINGS (Absolute-Maximum Values)

DC Plate Voltage	250	300	volts
DC Grid-No.3 (Suppressor) Voltage	0	0	volts
DC Grid-No.2 (Screen) Voltage	250	250	volts
DC Grid-No.1 (Control-Grid) Voltage	-125	-125	volts
DC Plate Current	40	50	mA
DC Grid-No.2 Current	15	15	mA
DC Grid-No.1 Current	5	5	mA
Plate Input	10	15	watts
Grid-No.2 Input	1.5	1.5	watts
Plate Dissipation	8	12	watts
Bulb Temperature (At hottest point on bulb surface)	250	250	°C

TYPICAL OPERATION UP TO 30 MHZ

DC Plate Voltage	250	300	
Grid No.3	Connected to cathode at socket		
DC Grid-No.2 Voltage [†]	250	250	volts
DC Grid-No.1 Voltage*	-39	-42.5	volts
From a grid resistor of	39000	18000	ohms
Peak RF Grid-No.1 Voltage	46.5	53.5	volts
DC Plate Current	40	50	mA
DC Grid-No.2 Current	5.6	6	mA
DC Grid-No.1 Current (Approx.)	1	2.4	mA
Driving Power (Approx.)	0.05	0.15	watt
Useful Power Output (Approx.)	6.4 [■]	10 [■]	watts

MAXIMUM CIRCUIT VALUE

Grid-No.1-Circuit Resistance	0.1	0.1	megohm
------------------------------	-----	-----	--------

RF Power Amplifier & Oscillator—Class C Telegraphy[□]
and
RF Power Amplifier—Class C FM Telephony

MAXIMUM RATINGS (Absolute-Maximum Values)

	CCS [●]	ICAS ^{●●}	
DC Plate Voltage	300	350	volts
DC Grid-No.3 (Suppressor) Voltage	0	0	volts
DC Grid-No.2 (Screen) Voltage	250	250	volts
DC Grid-No.1 (Control-Grid) Voltage	-125	-125	volts
DC Plate Current	50	50	mA
DC Grid-No.2 Current	15	15	mA
DC Grid-No.1 Current	5	5	mA
Plate Input	15	17	watts
Grid-No.2 Input	2	2	watts
Plate Dissipation	12	13.5	watts
Bulb Temperature (At hottest point on bulb surface)	250	250	°C

TYPICAL OPERATION UP TO 30 MHZ

DC Plate Voltage	300	350	volts
Grid No.3	Connected to cathode at socket		
DC Grid-No.2 Voltage	250	250	volts
DC Grid-No.1 Voltage [⊙]	-28.5	-28.5	volts
From a grid resistor of	18000	18000	ohms
Peak RF Grid-No.1 Voltage	37.5	37	volts
DC Plate Current	50	48.5	mA
DC Grid-No.2 Current	6.6	6.2	mA
DC Grid-No.1 Current (Approx.)	1.6	1.6	mA
Driving Power (Approx.)	0.1	0.1	watts
Useful Power Output (Approx.)	10.3 [■]	12 [■]	watts

TYPICAL OPERATION AT 50 MHZ

DC Plate Voltage	300	—	volts
Grid No.3	Connected to cathode at socket		
DC Grid-No.2 Voltage	250	—	volts
DC Grid-No.1 Voltage [⊙]	-60	—	volts
From a grid resistor of	22000	—	ohms
Peak RF Grid-No.1 Voltage	80	—	volts
DC Plate Current	50	—	mA
DC Grid-No.2 Current	5	—	mA
DC Grid-No.1 Current (Approx.)	3	—	mA
Driving Power (Approx.)	0.35	—	watt
Useful Power Output (Approx.)	7 [■]	—	watts

MAXIMUM CIRCUIT VALUE

Grid-No.1-Circuit Resistance	0.1	0.1	megohm
------------------------------	-----	-----	--------

Frequency Multiplier

MAXIMUM CCS[●] RATINGS (Absolute-Maximum Values)

DC Plate Voltage	300	volts
DC Grid-No.3 (Suppressor) Voltage	0	volts
DC Grid-No.2 (Screen) Voltage	250	volts
DC Grid-No.1 (Control-Grid) Voltage	-125	volts
DC Plate Current	50	mA
DC Grid-No.2 Current	15	mA
DC Grid-No.1 Current	5	mA
Plate Input	15	watts
Grid-No.2 Input	2	watts
Plate Dissipation	12	watts
Bulb Temperature (At hottest point on bulb surface)	250	°C

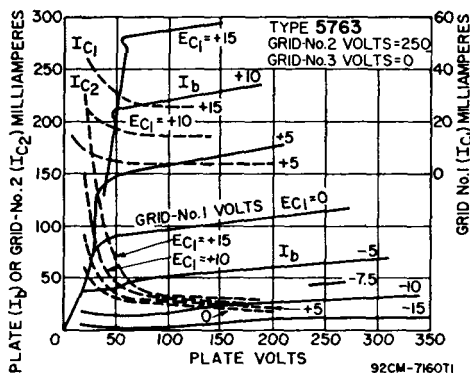

TYPICAL OPERATION

	Doubler to 175 MHz	Tripler to 175 MHz	
DC Plate Voltage	300	300	volts
Grid No.3	Connected to cathode	Connected to cathode	at socket
DC Grid-No.2 Voltage	*	*	volts
DC Grid-No.1 Voltage [⊗]	-75	-100	volts
From grid resistor of	75000	100000	ohms
Peak RF Grid-No.1 Voltage	95	120	volts
DC Plate Current	40	35	mA
DC Grid-No.2 Current	4	5	mA
DC Grid-No.1 Current (Approx.)	1	1	mA
Driving Power (Approx.)	0.6	0.6	watt
Useful Power Output (Approx.)	2.1 [■]	1.3 [■]	watts

MAXIMUM CIRCUIT VALUE (For maximum rated conditions)

Grid-No.1-Circuit Resistance	0.1	0.1	megohm
------------------------------	-----	-----	--------

† Obtained preferably from a separate source modulated with the plate supply, or from the modulated plate supply through a series resistor.

* Obtained from grid-No.1 resistor or from a combination of grid-No.1 resistor with either fixed supply or cathode resistor.

□ Key down conditions per tube without amplitude modulation. Modulation essentially negative may be used if the positive peak of the audio-frequency envelope does not exceed 115% of the carrier conditions.

⊗ Obtained from a fixed supply, or by a grid-No.1 resistor of value shown.

■ This value of useful power is measured at load of output circuit.

● Continuous Commercial Service.

●● Intermittent Commercial and Amateur Service.

* Obtained from plate supply of 300 volts through a series resistor of 12500 ohms.

Refer to chart at end of section.

5783

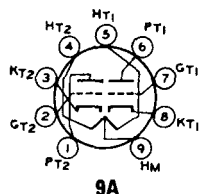

MEDIUM-MU TWIN TRIODE

5814A

INDUSTRIAL TYPE

Miniature type "Premium" medium-mu twin triode used in a wide variety of applications including mixers, oscillators, multivibrators and synchronizing amplifiers in industrial control equipment. Outlines section, 6B; requires miniature 9-contact socket.

Heater Arrangement	Series	Parallel	
Heater Voltage (ac/dc)	12.6 ±10%	6.3 ±10%	volts
Heater Current	0.175	0.350	ampere
Heater-Cathode Voltage:			
Peak value	±100 max	±100 max	volts
Direct Interelectrode Capacitances (Approx.)	Unit No. 1	Unit No. 2	
Grid to Plate	1.5	1.5	pF
Grid to Cathode and Heater	1.6	1.6	pF
Plate to Cathode and Heater	0.5	0.4	pF

Class A₁ Amplifier (Each Unit Unless Otherwise Specified)

MAXIMUM RATINGS (Design-Maximum Values)

Plate Voltage	330	volts
Cathode Current	22	mA
Plate Dissipation:		
Each Plate	3.0	watts
Both Plates (Both units operating)	6.0	watts
Bulb Temperature (At hottest point on bulb surface)	165	°C

CHARACTERISTICS

Plate Voltage	100	250	volts
Grid Voltage	0	-8.5	volts
Amplification Factor	19.5	17	
Plate Resistance (Approx.)	6250	7700	ohms
Transconductance	3100	2200	μmhos
Plate Current	11.8	10.5	mA
Grid Voltage (Approx.) for plate current of 10 μA	—	-22	volts

MAXIMUM CIRCUIT VALUES

Grid-Circuit Resistance:		
For fixed-bias operation	0.25	megohm
For cathode-bias operation	1	megohm

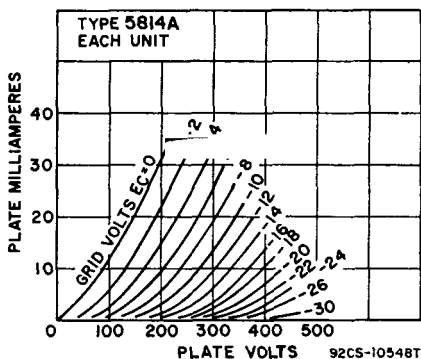

TYPICAL OPERATION AS RESISTANCE-COUPLED AMPLIFIER

See RESISTANCE-COUPLED AMPLIFIER CHART
type 12AU7A conditions

Special Ratings & Performance Data

SHOCK RATING		
Impact Acceleration	600 max.	g
FATIGUE RATING		
Vibrational Acceleration	2.5 max.	g
LOW-FREQUENCY VIBRATION PERFORMANCE		
RMS Output Voltage	100 max.	mV
HEATER-CYCLING LIFE PERFORMANCE		
Cycles of Intermittent Operation	2000 min.	cycles
AUDIO-FREQUENCY NOISE AND MICROPHONIC PERFORMANCE		
RMS Output Voltage	100 max.	mV

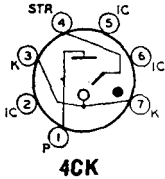

GLOW-DISCHARGE TRIODE

5823

INDUSTRIAL
TYPE

Miniature type, cold-cathode, glow discharge triode for use primarily as a relay control tube in "on-off" low current electrical circuits. Outlines section, 5C; requires miniature 7-contact socket.

MAXIMUM RATINGS* (Absolute-Maximum Values)

For First-Quadrant Operation Only

Peak Anode and Starter-Electrode Voltage:		
Inverse	200	volts
Forward	200	volts
Cathode Current:		
Peak	100	mA
Average*	25	mA
Peak Starter-Electrode Current:		
With starter-electrode voltage positive	100	mA
Ambient Temperature	-60 to +75	°C

TYPICAL OPERATING CONDITIONS

For Relay Service with 60-Hz Supply

AC Anode Supply Voltage (RMS)	117	volts
AC Starter-Electrode Voltage:		
Max. Peak Positive Pre-Firing Voltage	70	volts
Min. Peak Positive Triggering Voltage	35	volts
Min. Firing Voltage (Sum of In-Phase Instantaneous Pre-Firing Voltage and Instantaneous Triggering Voltage)	105	volts

* These ratings apply to the 5823 when it is operated from a power supply having a frequency of 60 Hz.

* Averaged over any interval of 15 seconds max.

Refer to chart at end of section.

5824

Refer to chart at end of section.

5840

Refer to chart at end of section.

5840W

Refer to chart at end of section.

5842/417A

Refer to chart at end of section.

5844

Refer to chart at end of section.

5847/404A

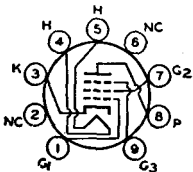

9AD

SHARP-CUTOFF PENTODE

5879

Miniature type used as audio amplifier in the input stages of medium-gain public-address systems, home sound recorders, and audio systems. Outlines section, 6B; requires miniature 9-contact socket. For operation as resistance-coupled amplifier, refer to Resistance-Coupled Amplifier section.

Heater Voltage (ac/dc)	6.3	volts
Heater Current	0.15	ampere
Peak Heater-Cathode Voltage	±100 max	volts
Direct Interelectrode Capacitances:		
Pentode Connection:		
Grid No.1 to Plate	0.11 max	pF
Grid No.1 to Cathode, Heater, Grid No.2, and Grid No.3	2.7	pF
Plate to Cathode, Heater, Grid No.2, and Grid No.3	2.4	pF
Triode Connection*:		
Grid No.1 to Plate	1.4	pF
Grid No.1 to Cathode and Heater	1.4	pF
Plate to Cathode and Heater	0.85	pF

* Grid No.2 and grid No.3 connected to plate.

Class A₁ Amplifier

MAXIMUM RATINGS (Design-Maximum Values)

	Triode Connection*	Pentode Connection	
Plate Voltage	275	330	volts
Grid-No.2 (Screen-Grid) Voltage	—	See curve page 300	volts
Grid-No.2 Supply Voltage	—	330	volts
Grid-No.1 (Control-Grid) Voltage:			
Negative-bias value	55	55	volts
Positive-bias value	0	0	volts
Plate Dissipation	1.7	1.25	watts
Grid-No.2 Input:			
For grid-No.2 voltages up to 165 volts	—	0.25	watt
For grid-No.2 voltages between 165 and 300 volts	—	See curve page 300	

CHARACTERISTICS

	100	250	250	
Plate Voltage	100	250	250	volts
Grid No.3	—	—	Connected to cathode at socket	volts
Grid-No.2 Voltage	—	—	100	volts
Grid-No.1 Voltage	-3	-8	-3	volts
Amplification Factor	21	21	—	
Plate Resistance (Approx.)	0.017	0.0137	2	megohms
Transconductance	1240	1530	1000	μmhos
Plate Current	2.2	5.5	1.8	mA
Grid-No.2 Current	—	—	0.4	mA
Grid-No.1 Voltage (Approx.) for plate current of 10 μA	—	—	-8	volts

MAXIMUM CIRCUIT VALUE

Grid-No.1-Circuit Resistance	2.2	megohms
------------------------------	-----	---------

* Grid No.2 and grid No.3 connected to plate.

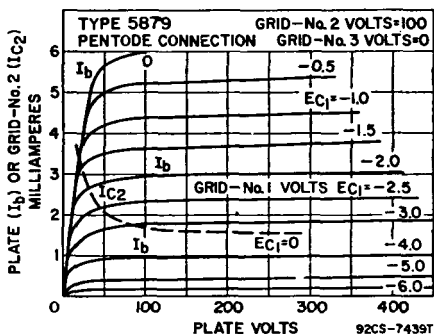
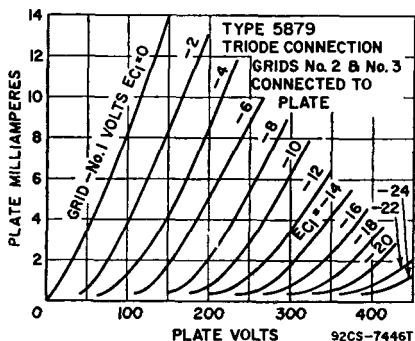

5881

Refer to chart at end of section.

5896

Refer to chart at end of section.

5899

Refer to chart at end of section.

5902

Refer to chart at end of section.

5915

Refer to chart at end of section.

5963

INDUSTRIAL
TYPE

MEDIUM-MU TWIN TRIODE

Miniature type medium-mu twin triode used for "on-off" control applications involving long periods of operation under cutoff conditions. Outlines section, 6B; requires miniature 9-contact socket.

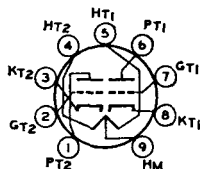

9A

Heater Arrangement	Series	Parallel	
Heater Voltage (ac/dc)	12.6 $\pm 10\%$	6.3 $\pm 10\%$	volts
Heater Current	0.15	0.30	ampere
Heater-Cathode Voltage:			
Peak value	± 90 max.	± 90 max.	volts
Direct Interelectrode Capacitances (Approx.):			
	Unit No. 1	Unit No. 2	
Grid to Plate	1.5	1.5	pF
Grid to Cathode and Heater	1.9	1.9	pF
Plate to Cathode and Heater	0.5	0.35	pF
Grid of Unit No.1 to grid of Unit No.2		0.1 max.	pF

**Frequency Divider in Computer Service
and "On-Off" Control Service**
Values are for Each Unit

MAXIMUM RATINGS (Absolute-Maximum Values)

Plate Voltage	250	volts
Grid Voltage:		
Negative bias value	100	volts
Positive bias value	0	volt
Peak negative value	200	volts
Plate Dissipation	2.5	watts
Grid Input	0.5	watt
Cathode Current:	100	mA
Peak	20	mA
DC	± 90 max.	volts
Bulb Temperature (At hottest point on bulb surface)	120	$^{\circ}\text{C}$

TYPICAL OPERATION AS FREQUENCY HALFER

	Cutoff Condition	Zero-Bias Condition	
Plate-Supply Voltage	150	150	volts
Grid Voltage	-15	0	volts
Plate-Circuit Resistance	20000	20000	ohms
Grid-Circuit Resistance	47000	47000	ohms
Plate Current	0	5.1	mA

MAXIMUM CIRCUIT VALUES

Grid-Circuit Resistance:		
For fixed-bias operation	0.5	megohm
For cathode-bias operation	1	megohm

Class A₁ Amplifier (Each Unit)

CHARACTERISTICS

Plate Voltage	67.5	volts
Grid Voltage	0	volts
Amplification Factor	21	
Plate Resistance (Approx.)	6600	ohms
Transconductance	3200	μmhos
Plate Current	8.5	mA

Refer to chart at end of section.

5964

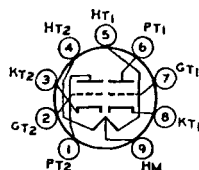

9A

MEDIUM-MU TWIN TRIODE

5965

INDUSTRIAL
TYPE

Miniature type medium-mu twin triode used for "on-off" control applications involving long periods of operation under cutoff conditions. Outlines section, 6B; requires miniature 9-contact socket.

Heater Arrangement	Series	Parallel	
Heater Voltage (ac/dc)	12.6 $\pm 10\%$	6.3 $\pm 10\%$	volts
Heater Current	0.225	0.45	ampere
Heater-Cathode Voltage:			
Peak value	± 200 max.	± 200 max.	volts
Average value	± 100 max.	± 100 max.	volts

Direct Interelectrode Capacitances (Approx.)	Unit No. 1	Unit No. 2	
Grid to Plate	3.0	3.0	pF
Grid to Cathode and Heater	3.8	3.8	pF
Plate to Cathode and Heater	0.5	0.38	pF
Plate of Unit No.1 to plate of Unit No.2	0.5		pF

Frequency Divider in Computer Service and "On-Off" Control Service

Values are for Each Unit

MAXIMUM RATINGS (Absolute-Maximum Values)		
Plate Voltage	330	volts
Grid Voltage:		
Negative bias value	150	volts
Plate Dissipation	2.4	watts
Total for both units	4.4	watts
DC Cathode Current	16.5	mA
Bulb Temperature (At hottest point on bulb surface)	165	°C

TYPICAL OPERATION IN COMPUTER SERVICE

	Cutoff Condition	Conduction Condition	
Plate Supply Voltage	150	150	volts
Plate Load Resistor	7200	7200	ohms
Plate Current	—	10.5	mA
Grid Voltage (Approx.) for grid current of 140 μ A	—	less than 1	volt
Grid Voltage (Approx.) for plate current of 150 μ A	-5.5	—	volts
Difference in Grid Voltage Between Units (For plate current of 150 μ A per unit)	1.5	—	volts

MAXIMUM CIRCUIT VALUES

Grid-Circuit Resistance:		
For fixed-bias operation	0.1	megohm
For cathode-bias operation	0.5	megohm

Class A₁ Amplifier (Each Unit)

CHARACTERISTICS		
Plate Supply Voltage	150	volts
Cathode-Bias Resistor	220	ohms
Amplification Factor	47	
Plate Resistance	7250	ohms
Transconductance	6500	μ mhos
Plate Current	8.2	mA
Grid Voltage (Approx.) for plate current of 150 μ A	-5.5	volts

6005 Refer to chart at end of section.

6005/6AQ5W Refer to chart at end of section.

**6005/6AQ5W/
6095** Refer to chart at end of section.

6012

INDUSTRIAL
TYPE

GAS THYRATRON

Glass octal negative-control gas-tetrode thyatron for use in relay and grid-controlled rectifier applications. Outlines section, 36; requires octal socket.

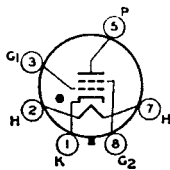

6C0

Heater Voltage (ac/dc)	Min. 5.7	Av. 6.3	Max. 6.9	volts
Heater Current	—	2.6	2.85	amperes
Heater-Cathode Voltage:				
Peak		+25,	-100 max.	volts
Cathode:				
Minimum heating time prior to tube conduction		30		seconds
Maximum outage time without reheating		5		seconds
Direct Interelectrode Capacitances (Approx.):				
Grid No.1 to Anode		0.23		pF
Grid No.1 to Cathode, Grid No.2, and Heater		5.8		pF
Anode to Cathode, Grid No.2, and Heater		3.9		pF

Ionization Time (Approx.):

For conditions: dc anode volts = 100, grid-No.2 volts = 0, grid-No.1 square-pulse volts = +50, and peak anode amperes during conduction = 5 0.5 μ S

Deionization Time (Approx.) See Table I

Maximum Critical Grid-No.1 Current:

For conditions: ac anode-supply volts = 460 (rms), and average anode amperes = 0.5 3 μ A

Anode Voltage Drop (Approx.) 10 volts

Grid-No.1 Control Ratio (Approx.):

For conditions: grid-No.1 resistor (megohms) = 0, grid-No.2 resistor (megohms) = 0, and grid-No.2 volts = 0 150

Grid-No.2 Control Ratio (Approx.):

For conditions: grid-No.1 resistor (megohms) = 0, grid-No.2 resistor (megohms) = 0, and grid-No. volts = 0 650

Relay and Grid-Controlled Rectifier Service

For Anode-Supply Frequency of 60 Hz

MAXIMUM RATINGS (Absolute-Maximum Values)

Peak Anode Voltage:

Forward 650 volts

Inverse 1300 volts

Grid-No.2 (Shield-Grid) Voltage:

Peak, before tube conduction -100 volts

Average#, during tube conduction -10 volts

Grid-No.1 (Control-Grid) Voltage:

Peak, before tube conduction -200 volts

Average#, during tube conduction -10 volts

Cathode Current:

Peak 5 amperes

Average# 0.5 ampere

Fault, for duration of 0.1 second max. 20 amperes

Average Grid-No.2 Current# +0.05 ampere

Average Grid-No.1 Current# +0.05 ampere

Ambient-Temperature Range -75 to +90 °C

MAXIMUM CIRCUIT VALUE

Grid-No.1-Circuit Resistance 2 megohms

Averaged over any interval of 30 seconds maximum.

OPERATIONAL RANGE OF CRITICAL GRID-NO1 VOLTAGE

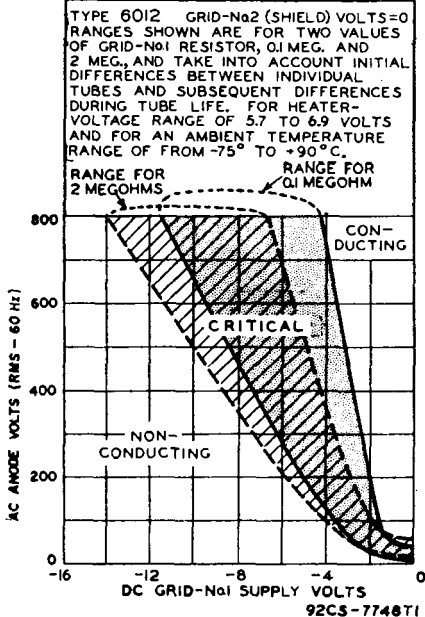

Table 1

DC Anode Volts	125		250		R_{E1} M Ω	E_{CC1} volts	R_{E2}^* ohms	E_{CC2} volts
DC Anode Amperes	0.5	1.0	0.5	1.0				
DEIONIZATION TIME	175	225	250	275	0.001	-13	1000	0
	350	375	450	475	0.1			
	650	700	1100	1200	2			
μ S (Approx.)	100	125	100	125	0.001	-100	1000	0
	125	150	150	175	0.1			
	250	275	275	300	2			

* Series resistor between grid No.2 and cathode.

- 6021** Refer to chart at end of section.
- 6072** Refer to chart at end of section.
- 6072A** Refer to chart at end of section.
- 6073** Refer to chart at end of section.
- 6073/OA2** Refer to chart at end of section.
- 6074** Refer to chart at end of section.
- 6074/OB2** Refer to chart at end of section.

6080

INDUSTRIAL
TYPE

LOW-MU TWIN POWER TRIODE

Glass octal type used as a regulator tube in dc power supply units and in projection television booster scanning applications. Outlines section, 36; requires octal socket.

Heater Voltage	6.3 \pm 10%	volts
Heater Current	2.5	amperes
Heater-Cathode Voltage: # Peak	\pm 300 max.	volts
Direct Interelectrode Capacitances (Approx.)		
Grid to Plate (each unit)	8	pF
Input (each unit)	6	pF
Output (each unit)	2.2	pF
Heater to Cathode (each unit)	11	pF
Grid of Unit No.1 to Grid of Unit No.2	0.5	pF
Plate of Unit No.1 to Plate of Unit No.2	2	pF

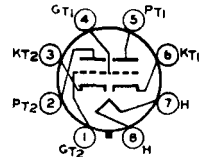

8BD

Class A₁ Amplifier (Each Unit)

CHARACTERISTICS

Plate-Supply Voltage	135	volts
Cathode-Bias Resistor	250	ohms
Amplification Factor	2	
Plate Resistance	280	ohms
Transconductance	7000	μ mhos
Plate Current	125	mA

DC Amplifier (Each Unit)

MAXIMUM RATINGS (Absolute-Maximum Values)

Plate Voltage	250	volts
Plate Current	125	mA
Plate Dissipation	13	watts
Bulb Temperature (At hottest point on bulb surface)	200	$^{\circ}$ C

MAXIMUM CIRCUIT VALUES

Grid-Circuit Resistance:

For cathode-bias operation	1	megohm
For fixed-bias operation□	0.1	megohm
For combined fixed and cathode-bias operation*	0.1	megohm

Booster Scanning Service (Each Unit)

MAXIMUM RATINGS (Absolute-Maximum Values)

For operation in a 525-line, 30-frame system

Peak Negative-Pulse Plate Voltage●	3000	volts
Peak Negative-Pulse Grid Voltage	2300	volts
DC Plate Current	125	mA
Plate Dissipation	13	watts

MAXIMUM CIRCUIT VALUES (For maximum rated conditions)

Grid-Circuit Resistance:

For cathode-bias operation	1	megohm
For fixed-bias operation		not recommended

□ When fixed bias is used, the plate circuit should contain a protective resistance to provide a minimum drop of 15 volts dc at the normal operating conditions.

* When combined fixed- and cathode-bias is used, the cathode-bias portion should have a minimum value of 7.5 volts dc at the normal operating conditions.

● Pulse duration must not exceed 15 per cent of one horizontal scanning cycle (10 micro-seconds).

Operation of this tube is not recommended with a damper pulse between heater and cathode.

Special Ratings & Performance Data

SHOCK RATING

Impact Acceleration	450 max.	g
---------------------------	----------	---

FATIGUE RATING

Vibrational Acceleration	2.5 max.	g
--------------------------------	----------	---

LOW-FREQUENCY VIBRATION PERFORMANCE

RMS Output Voltage	200 max.	mV
--------------------------	----------	----

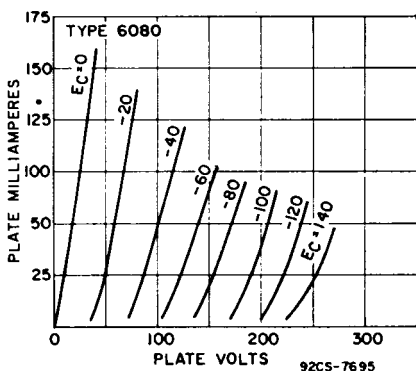

Refer to chart at end of section.

6080WA

Refer to chart at end of section.

6082

Refer to chart at end of section.

6101

Refer to chart at end of section.

6101/6J6WA

Refer to chart at end of section.

6111

6112	Refer to chart at end of section.
6136	Refer to chart at end of section.
6186	Refer to chart at end of section.
6186/6AG5WA	Refer to chart at end of section.
6186W	Refer to chart at end of section.
6189	Refer to chart at end of section.
6197	Refer to chart at end of section.

6201INDUSTRIAL
TYPE**HIGH-MU TWIN TRIODE**

Miniature type used in mixer, oscillator, and amplifier applications at frequencies up to 300 MHz. Outlines section, 6B; requires miniature 9-contact socket. For typical operation as a resistance-coupled amplifier, refer to Resistance-Coupled Amplifier section, type 12AT7 conditions.

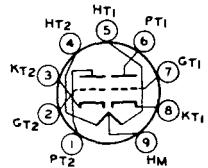
**9A**

Heater Arrangement:	Series	Parallel	
Heater Voltage (ac/dc)	12.6	6.3	volts
Heater Current	0.15	0.3	ampere
Peak Heater-Cathode Voltage		±100 max.	volts
Direct Interelectrode Capacitances (Approx.):			
Grid-Drive Operation:			
Grid to Plate (Each unit)		1.6	pF
Grid to Cathode and Heater (Each unit)		2.5	pF
Plate to Cathode and Heater:			
Unit No.1		0.45	pF
Unit No.2		0.38	pF
Heater to Cathode (Each unit)		2.8	pF
Cathode-Drive Operation:			
Cathode to Plate (Unit No.1)		0.2	pF
Cathode to Plate (Unit No.2)		0.24	pF
Cathode to Grid and Heater (Each unit)		5	pF
Plate to Grid and Heater (Unit No.1)		1.9	pF
Plate to Grid and Heater (Unit No.2)		1.8	pF

Class A₁ Amplifier (Each Unit)**MAXIMUM RATINGS (Absolute-Maximum Values)**

Plate Voltage	330	volts
Grid Voltage:		
Negative bias value	55	volts
Positive bias value	0	volt
Plate Dissipation	2.75	watts
Bulb Temperature (At hottest point on bulb surface)	180	°C

MAXIMUM CIRCUIT VALUES

Grid-Circuit Resistance:		
For fixed-bias operation	0.25	megohm
For cathode-bias operation	1.0	megohm

CHARACTERISTICS

Plate Supply Voltage	100	250	volts
Cathode-Bias Resistor	270	200	ohms
Amplification Factor	57	60	
Plate Resistance (Approx.)	14300	10900	ohms
Transconductance	4000	5500	μmhos
Grid Voltage (Approx.) for plate current of 10 μA	-5	-12	volts
Plate Current	3.3	10	mA

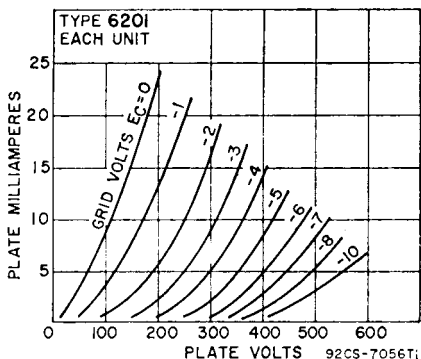

Special Ratings & Performance Data

SHOCK RATING		
Impact Acceleration	600 max.	κ
FATIGUE RATING		
Vibrational Acceleration	2.5 max.	κ
LOW-FREQUENCY VIBRATION PERFORMANCE		
RMS Output Voltage	100 max.	mV
HEATER-CYCLING LIFE PERFORMANCE		
Cycles of Intermittent Operation	2000 min.	cycles
AUDIO-FREQUENCY NOISE AND MICROPHONIC PERFORMANCE		
RMS Output Voltage	100 max.	mV

- Refer to chart at end of section. **6202**
- Refer to chart at end of section. **6206**
- Refer to chart at end of section. **6211**
- Refer to chart at end of section. **6336A**
- Refer to chart at end of section. **6350**
- Refer to chart at end of section. **6360**
6360A
- Refer to chart at end of section. **6386**
- Refer to chart at end of section. **6417**
- Refer to chart at end of section. **6485**

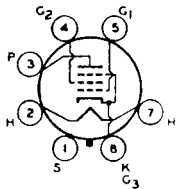

7S

BEAM POWER TUBE

6550
INDUSTRIAL
TYPE

Glass octal type used in the output stages of high-fidelity audio amplifiers. **Outlines section, 27C**; requires octal socket. This tube should be adequately ventilated.

Heater Voltage (ac/dc)	6.3	volts
Heater Current	1.6	amperes
Peak Heater-Cathode Voltage:		
Heater negative with respect to cathode	300 max.	volts
Heater positive with respect to cathode	200* max.	volts

Direct Interelectrode Capacitances (Approx.):

Grid No.1 to plate	0.85	pF
Grid No.1 to cathode and grid No.3, grid No.2, base sleeve and heater	14.0	pF
Plate to cathode & grid No.3, grid No.2, base sleeve, and heater	12.0	pF

MAXIMUM CIRCUIT VALUES

Grid-No.1-Circuit Resistance:		
For fixed-bias operation	0.05	megohm
For cathode-bias operation	0.25	megohm

Class A₁ AF Power Amplifier

MAXIMUM RATINGS (Design-Center Values)

Plate Voltage	600	volts
Grid-No.2 (Screen-Grid) Voltage	400	volts
Grid-No.1 (Control-Grid) Voltage:		
Negative-bias value	300	volts
Positive-bias value	0	volt
Cathode Current	175	mA
Grid-No.2 Input	6	watts
Plate Dissipation	35	watts
Bulb Temperature (At hottest point on bulb surface)	250	°C

TYPICAL OPERATION AND CHARACTERISTICS

Plate Voltage	250	400	volts
Grid-No.2 Voltage	250	225	volts
Grid-No.1 Voltage	-14	-16.5	volts
Peak AF Grid-No.1 Voltage	14	16.5	volts
Zero-Signal Plate Current	140	87	mA
Max.-Signal Plate Current	150	105	mA
Zero-Signal Grid-No.2 Current	12	4	mA
Max.-Signal Grid-No.2 Current	28	1.8	mA
Plate Resistance (Approx.)	12000	27000	ohms
Transconductance	11000	9000	μmhos
Load Resistance	1500	3000	ohms
Total Harmonic Distortion	7	13.5	%
Max.-Signal Power Output	12.5	20	watts

Class A₁ Push-Pull AF Power Amplifier

MAXIMUM RATINGS (Design-Center Values)

Same as for Class A₁ AF POWER AMPLIFIER

TYPICAL OPERATION AND CHARACTERISTICS

Values are for 2 tubes

	Fixed Bias		Cathode Bias	
Plate Supply Voltage	400	600	400	volts
Grid-No.2 Supply Voltage	275	300	300	volts
Grid-No.1 Voltage	-23	-31	—	volts
Cathode Resistor	—	—	140	ohms
Peak AF Grid-No.1-to-Grid-No.1 Voltage	46	62	53	volts
Zero-Signal Plate Current	180	115	166	mA
Max.-Signal Plate Current	270	273	190	mA
Zero-Signal Grid-No.2 Current	9	4	7.5	mA
Max.-Signal Grid-No.2 Current	44	41	39	mA
Effective Load Resistance (Plate to plate)	3500	5000	4500	ohms
Total Harmonic Distortion	3	2.5	4	%
Max.-Signal Power Output	55	100	41	watts

* The dc component must not exceed 100 volts.

6626/0A2WA

Refer to chart at end of section.

6660/6BA6

Refer to chart at end of section.

6661/6BH6

INDUSTRIAL
TYPE

SHARP-CUTOFF PENTODE

Miniature type used as an rf amplifier particularly in mobile equipment where low heater-current drain is important. It is particularly useful in high-frequency, wide-band applications. Outlines section, 5C; requires miniature 7-contact socket.

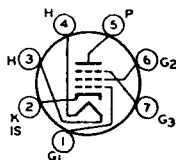

7CM

Heater Voltage (ac/dc)	6.3 ±20%	volts
Heater Current	0.15	ampere
Peak Heater-Cathode Voltage	±100 max.	volts
Direct Interelectrode Capacitances:		
Grid No.1 to Plate	0.0035 max.	pF
Grid No.1 to Cathode, Heater, Grid No.2, Grid No.3, and Internal Shield	5.4	pF
Plate to Cathode, Heater, Grid No.2, Grid No.3, and Internal Shield	4.4	pF

Class A₁ Amplifier

MAXIMUM RATINGS (Design-Maximum Values)

Plate Voltage	330	volts
Grid-No.2 (Screen-Grid) Voltage	See curve page 300	
Grid-No.2 Supply Voltage	330	volts
Grid-No.1 (Control-Grid) Voltage:		
Negative-bias value	55	volts
Positive-bias value	0	volt
Plate Dissipation	3.3	watts
Grid-No.2 Input:		
For Grid-No.2 voltages up to 165 volts	0.55	watt
For Grid-No.2 voltages between 165 and 300 volts	See curve page 300	

CHARACTERISTICS

Plate Voltage	250	volts
Grid No.3	Connected to cathode at socket	
Grid-No.2 Voltage	150	volts
Cathode Resistor	100	ohms
Plate Resistance (Approx.)	1.4	megohms
Transconductance	4600	μmhos
Plate Current	7.4	mA
Grid-No.2 Current	2.6	mA
Grid-No.1 Voltage (Approx.) for plate current of 10 μA	-7.7	volts

TRANSCONDUCTANCE AT REDUCED HEATER VOLTAGE

Average Value	3600	μmhos
With heater volts = 5, plate supply volts = 250, grid No.3 connected to cathode at socket, grid-No.2 supply volts = 150, and cathode resistor (ohms) bypassed = 100.		

- Refer to chart at end of section. **6662/6BJ6**
- Refer to chart at end of section. **6663/6AL5**
- Refer to chart at end of section. **6664/6AB4**

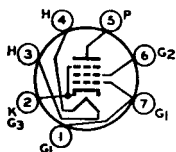

7BZ

BEAM POWER TUBE

Miniature type used as output amplifier primarily in mobile communications equipment. Outlines section, 5D; requires miniature 7-contact socket.

**6669/
6AQ5A**
INDUSTRIAL
TYPE

Heater Voltage (ac/dc)	6.3 ±20%	volts
Heater Current	0.45	ampere
Heater Warm-up Time (Average)	11	seconds
Heater-Cathode Voltage:		
Peak value	±100 max.	volts
Direct Interelectrode Capacitances (Approx.):		
Grid No.1 to Plate	0.4	pF
Grid No.1 to Cathode, Heater, Grid No.2, and Grid No.3	8	pF
Plate to Cathode, Heater, Grid No.2, and Grid No.3	8.5	pF

Class A₁ Amplifier

MAXIMUM RATINGS (Design-Maximum Values)

Plate Voltage	250	volts
Grid-No.2 (Screen-Grid) Voltage	250	volts
Plate Dissipation	12	watts
Grid-No.2 Input	2	watts
Bulb Temperature (At hottest point on bulb surface)	225	°C

TYPICAL OPERATION AND CHARACTERISTICS

Plate Voltage	250	volts
Grid-No.2 Voltage	250	volts
Grid-No.1 (Control-Grid) Voltage	-12.5	volts
Peak AF Grid-No.1 Voltage	12.5	volts
Zero-Signal Plate Current	45	mA
Max.-Signal Plate Current	47	mA
Zero-Signal Grid-No.2 Current	4.5	mA
Max.-Signal Grid-No.2 Current	7	mA
Plate Resistance (Approx.)	52000	ohms
Transconductance	4100	μmhos
Load Resistance	5000	ohms
Total Harmonic Distortion	8	%
Max.-Signal Power Output	4.5	watts

MAXIMUM CIRCUIT VALUES

Grid-No.1-Circuit Resistance:		
For fixed-bias operation	0.1	megohm
For cathode-bias operation	0.5	megohm

Class AB₁ AmplifierMAXIMUM RATINGS (Same as for Class A₁ Amplifier)

TYPICAL PUSH-PULL OPERATION

Unless otherwise specified, values are for 2 tubes

Plate Voltage	250	volts
Grid-No.2 Voltage	250	volts
Grid-No.1 (Control-Grid) Voltage	-15	volts
Peak AF Grid-No.1-to-Grid-No.1 Voltage	30	volts
Zero-Signal Plate Current	70	mA
Max.-Signal Plate Current	79	mA
Zero-Signal Grid-No.2 Current	5	mA
Max.-Signal Grid-No.2 Current	13	mA
Effective Load Resistance (Plate to plate)	10000	ohms
Total Harmonic Distortion	5	%
Max.-Signal Power Output	10	watts

MAXIMUM CIRCUIT VALUES (Same as for Class A₁ Amplifier)

POWER OUTPUT AT REDUCED HEATER VOLTAGE

Average Value	4.1	watts
With heater volts = 5, plate volts = 250, grid-No.2 volts = 250, grid-No.1 volts = -12.5, rms signal volts = 8.8, and load resistance (ohms) = 5000.		

6676/6CB6A

Refer to chart at end of section.

6677/6CL6

Refer to chart at end of section.

6678/6U8A

Refer to chart at end of section.

6679/12AT7

INDUSTRIAL
TYPE

HIGH-MU TWIN TRIODE

Miniature type used as a mixer, oscillator or amplifier in mobile communications equipment. Outlines section, 6B; requires miniature 9-contact socket. For typical operation as a resistance-coupled amplifier, refer to Resistance-Coupled Amplifier section, type 12AT7 conditions.

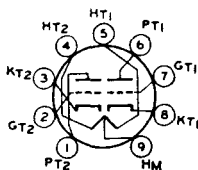

9A

Heater Arrangement:			
Heater Voltage (ac/dc)	Series	Parallel	
Heater Current	12.6 ±20%	6.3 ±20%	volts
Peak Heater-Cathode Voltage	0.15	0.3	ampere
Direct Interelectrode Capacitances (Approx.):		±100 max.	volts
Grid-Drive Operation:			
Grid to Plate (Each unit)		1.5	pF
Grid to Cathode and Heater (Each unit)		2.2	pF
Plate to Cathode and Heater:			
Unit No.1		0.5	pF
Unit No.2		0.4	pF
Cathode-Drive Operation:			
Cathode to Plate (Each unit)		0.2	pF
Cathode to Grid and Heater (Each unit)		4.6	pF
Plate to Grid and Heater (Each unit)		1.8	pF
Heater to Cathode (Each unit)		2.4	pF

Class A₁ Amplifier (Each Unit)

MAXIMUM RATINGS (Design-Maximum Values)

Plate Voltage	330	volts
Grid Voltage:		
Negative bias value	55	volts
Positive bias value	0	volt
Plate Dissipation	2.8	watts

CHARACTERISTICS

Plate Supply Voltage	250	volts
Cathode-Bias Resistor	200	ohms
Amplification Factor	60	
Plate Resistance (Approx.)	10900	ohms
Transconductance	5500	μmhos
Grid Voltage (Approx.) for plate current of 10 μA	-12	volts
Plate Current	10	mA

TRANSCONDUCTANCE AT REDUCED HEATER VOLTAGE

Average Value (Each unit)	4400	μmhos
With heater volts = 10 (Series connection), plate supply volts = 250, and cathode resistor (ohms) bypassed = 200.		

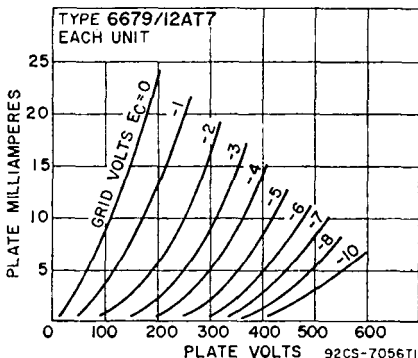

**6680/
MEDIUM-MU TWIN TRIODE
12AU7A
INDUSTRIAL
TYPE**

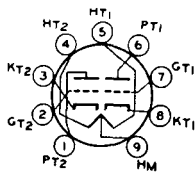

9A

Miniature type used as a phase inverter or push-pull amplifier in mobile communications equipment. **Outlines section, 6B**; requires miniature 9-contact socket. For typical operation as a resistance-coupled amplifier, refer to **Resistance-Coupled Amplifier** section, type 12AU7A conditions.

	Series	Parallel	
Heater Arrangement			
Heater Voltage (ac/dc)	12.6 ±20%	6.3 ±20%	volts
Heater Current	0.15	0.3	ampere
Heater-Cathode Voltage:			
Peak value		±200 max.	volts
Average value		100 max.	volts
Direct Interelectrode Capacitances (Approx.):	Unit No. 1	Unit No. 2	
Grid to Plate	1.5	1.5	pF
Grid to Cathode and Heater	1.6	1.6	pF
Plate to Cathode and Heater	0.4	0.32	pF

Class A₁ Amplifier (Each Unit Unless Otherwise Specified)

MAXIMUM RATINGS (Design-Maximum Values)

Plate Voltage	330	volts
Grid Voltage, positive-bias value	0	volt
Plate Dissipation:		
Each Plate	3	watts
Both Plates (Both units operating)	6	watts

CHARACTERISTICS

Plate Voltage	100	250	volts
Grid Voltage	0	-8.5	volts
Amplification Factor	20	17	
Plate Resistance (Approx.)	6500	7700	ohms
Transconductance	3100	2200	μmhos
Plate Current	11.8	10.5	mA
Grid Voltage (Approx.) for plate current of 10 μA	---	-24	volts

MAXIMUM CIRCUIT VALUES

Grid-Circuit Resistance:		
For fixed-bias operation	0.25	megohm
For cathode-bias operation	1	megohm

TRANSCONDUCTANCE AT REDUCED HEATER VOLTAGE

Average Value (Each unit)	1750	μmhos
With heater volts = 10 (Series connection), plate volts = 250, and grid volts = -8.5.		

6681/ 12AX7A

INDUSTRIAL
TYPE

HIGH-MU TWIN TRIODE

Miniature type used as a phase inverter or twin resistance-coupled amplifier in mobile communications equipment. Outlines section, 6B; requires miniature 9-contact socket. For typical operation as a resistance-coupled amplifier, refer to Resistance-Coupled Amplifier section, type 12AX7A conditions.

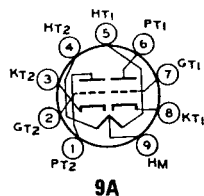

	Series	Parallel	
Heater Arrangement:			
Heater Voltage (ac/dc)	12.6 ±20%	6.3 ±20%	volts
Heater Current	0.15	0.3	ampere
Heater-Cathode Voltage:			
Peak value		±200 max.	volts
Average value		100 max.	volts
Direct Interelectrode Capacitances (Approx.):	Unit No. 1	Unit No. 2	
Grid to Plate	1.7	1.7	pF
Grid to Cathode and Heater	1.6	1.6	pF
Plate to Cathode and Heater	0.46	0.34	pF

Class A₁ Amplifier (Each Unit)

MAXIMUM RATINGS (Design-Maximum Values)

Plate Voltage	330	volts
Grid Voltage:		
Negative-bias value	55	volts
Positive-bias value	0	volt
Plate Dissipation	1.1	watts

CHARACTERISTICS

Plate Voltage	100	250	volts
Grid Voltage	-1	-2	volts
Amplification Factor	100	100	
Plate Resistance (Approx.)	80000	62500	ohms
Transconductance	1250	1600	μmhos
Plate Current	0.5	1.2	mA

Refer to chart at end of section. **6686**

Refer to chart at end of section. **6688A**

Refer to chart at end of section. **6887**

Refer to chart at end of section. **6922/E88CC**

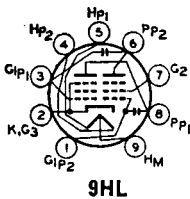

9HL

TWIN-POWER PENTODE

6939

INDUSTRIAL TYPE

Miniature type twin power-pentode intended for use in communications equipment as a push-pull rf power-amplifier or frequency-multiplier at frequencies up to 500 MHz. Outlines section, 6E; requires miniature 9-contact socket.

	Series	Parallel	
Heater arrangement			
Heater Voltage (ac/dc)	12.6 ±10%	6.3 ±10%	volts
Heater Current	0.3	0.6	ampere
Peak Heater-Cathode Voltage		±100 max.	volts
Bulb Temperature (At hottest point on bulb surface)		225 max.	°C
Direct Interelectrode Capacitances (Approx., Each Unit):			
Grid No.1 to Plate		0.15	pF
Grid No.1 to Cathode & Grid No.3, Grid No.2, and Heater		6.4	pF
Plate to Cathode & Grid No.3, Grid No.2, and Heater		1.6	pF
Transconductance (Each Unit) for dc plate volts = 150, dc grid-No.2 volts = 150, and dc plate mA = 25		10500	μmhos
Mu-Factor, grid No.2 to grid No.1 (Each Unit) for dc plate volts = 150, dc grid No.2 volts = 150, and dc plate mA = 25		31	

**Push-Pull RF Amplifier & Oscillator—Class C Telegraphy*
and
Push-Pull RF Power Amplifier—Class C FM Telephony**

Values are on a per-tube basis unless otherwise specified

MAXIMUM RATINGS (Absolute-Maximum Values)

	Up to 500 MHz		
	CCS*	ICAS†	
DC Plate Voltage	250	250	volts
DC Grid-No.2 (Screen-Grid) Voltage	200	200	volts
DC Grid-No.1 (Control-Grid) Voltage	-100	-100	volts
DC Plate Current	90	100	mA
DC Grid-No.1 Current	6	8	mA
DC Cathode Current	190	120	mA
Plate Input	12	14	watts
Grid-No.2 Input	3	3.5	watts
Grid-No.1 Input	0.2	0.24	watt
Plate Dissipation	6	7.5	watts

TYPICAL OPERATION

	At 500 MHz		
DC Plate Voltage	180	200	volts
DC Grid-No.2 Voltage	180	200	volts
DC Grid-No.1 Voltage	-20	-20	volts
From grid resistor for each grid No.1 of	27000	27000	ohms
Peak-to-Peak RF Grid-No.1 Voltage	50	50	volts
DC Plate Current	55	60	mA
DC Grid-No.2 Current	12.5	14	mA
DC Grid-No.1 Current	1.5	1.5	mA
Driver Power Output (Approx.)	1.2	1.2	watts
Useful Power Output (Approx.)†	5	6	watts

Plate-Modulated Push-Pull RF Power Amplifier—Class C Telephony

Carrier conditions per tube for use with a maximum modulation factor of 1
Values are on a per-tube basis

MAXIMUM RATINGS (Absolute-Maximum Values)

	Up to 500 MHz		
	CCS*	ICAS [†]	
DC Plate Voltage	200	200	volts
DC Grid-No.2 (Screen-Grid) Voltage	200	200	volts
DC Grid-No.1 (Control-Grid) Voltage	-100	-100	volts
DC Plate Current	64	80	mA
DC Grid-No.1 Current	6	8	mA
DC Cathode Current	80	96	mA
Plate Input	8	10	watts
Grid-No.2 Input	2	2.3	watts
Grid-No.1 Input	0.2	0.24	watt
Plate Dissipation	4	5	watts

TYPICAL OPERATION

	At 500 MHz		
	CCS*	ICAS [†]	
DC Plate Voltage	180	180	volts
DC Grid-No.2 Voltage	180	180	volts
DC Grid-No.1 Voltage	-20	-20	volts
From grid resistor for each grid No.1 of	68000	27000	ohms
Peak-to-Peak RF Grid-No.1 Voltage	45	50	volts
DC Plate Current	40	55	mA
DC Grid-No.2 Current	9.5	12.5	mA
DC Grid-No.1 Current	0.6	1.5	mA
Driver Power Output (Approx.)	1	1.2	watts
Useful Power Output (Approx.) [‡]	3.5	5	watts

Frequency Tripler—Class C

Values are on a per-tube basis

MAXIMUM RATINGS (Absolute-Maximum Values)

	Up to 500 MHz		
	CCS*	ICAS [†]	
DC Plate Voltage	250	250	volts
DC Grid-No.2 (Screen-Grid) Voltage	200	200	volts
DC Grid-No.1 (Control-Grid) Voltage	-100	-100	volts
DC Plate Current	60	80	mA
DC Grid-No.1 Current	6	8	mA
DC Cathode Current	70	80	mA
Plate Input	8	10	watts
Grid-No.2 Input	3	3.5	watts
Grid-No.1 Input	0.2	0.24	watt
Plate Dissipation	6	7.5	watts

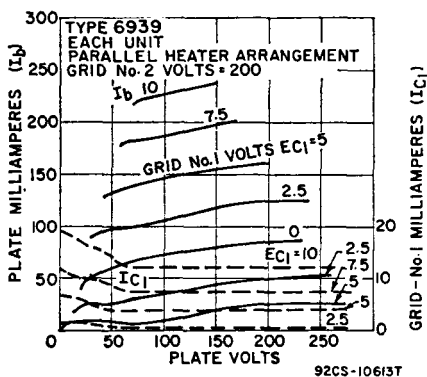

TYPICAL OPERATION

	Up to 500 MHz		
DC Plate Voltage	180	200	volts
DC Grid-No.2 Voltage (Approx.)	180	190	volts
Through resistor of	1200	1200	ohms
DC Grid-No.1 Voltage	-74	-74	volts
From grid resistor for each grid No.1 of	82000	82000	ohms
Peak-to-Peak RF Grid-No.1 Voltage	165	165	volts
DC Plate Current	40	46	mA
DC Grid-No.2 Current	9.7	11	mA
DC Grid-No.1 Current	1.8	1.8	mA
Driver Power Output (Approx.)	1.1	1.1	watts
Useful Power Output (Approx.) [‡]	1.8	2.2	watts

• Key-down conditions per tube without amplitude modulation. Amplitude modulation essentially negative may be used if the positive peak of the audio-frequency envelope does not exceed 115% of the carrier conditions.

* Continuous Commercial Service.

‡ Intermittent Commercial and Amateur Service.

‡ This value of useful power is measured at load of output circuit.

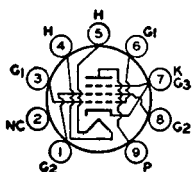

9EU

BEAM POWER TUBE

6973

Miniature type used as power amplifier in compact high-fidelity audio equipment. Outlines section, 6G; requires miniature 9-contact socket.

Heater Voltage (ac/dc)	6.3	volts
Heater Current	0.45	ampere
Heater-Cathode Voltage:		
Peak value	±200 max	volts
Average value	100 max	volts
Direct Interelectrode Capacitances:		
Grid-No.1 to Plate	0.4 max	pF
Grid No.1 to Cathode, Heater, Grid No.2, and Grid No.3	9	pF
Plate to Cathode Heater, Grid No.2, and Grid No.3	6	pF

Class A₁ Amplifier

CHARACTERISTICS

Plate Voltage	250	volts
Grid-No.2 (Screen-Grid) Voltage	250	volts
Grid-No.1 (Control-Grid) Voltage	-15	volts
Plate Resistance (Approx.)	73000	ohms
Transconductance	4800	μmhos
Plate Current	46	mA
Grid-No.2 Current	3.5	mA
Grid-No.1 Voltage (Approx.) for plate current of 100 μA	-40	volts

Push-Pull Class AB₁ Amplifier

MAXIMUM RATINGS (Design-Maximum Values)

Plate Voltage	440	volts
Grid-No.2 Voltage	330	volts
Plate Dissipation	12	watts
Grid-No.2 Input	2	watts
Bulb Temperature (At hottest point)	250	°C

TYPICAL OPERATION (Values are for two tubes)

	Fixed Bias			Cathode Bias		
Plate Supply Voltage	250	350	400	300	310	volts
Grid-No.2 Supply Voltage	250	280	290	300	310	volts
Grid-No.1 Voltage	-15	-22	-25	—	—	volts
Cathode-Bias Resistor	—	—	—	230	270	ohms
Peak AF Grid-No.1-to-						
Grid-No.1 Voltage	30	44	50	48	55	volts
Zero-Signal Plate Current	92	58	50	80	77	mA
Maximum-Signal Plate Current	105	106	107	96	92	mA
Zero-Signal Grid-No.2 Current	7	3.5	2.5	6	5	mA
Maximum-Signal Grid-No.2 Current	16	14	13.7	14	14	mA
Effective Load Resistance						
(Plate-to-plate)	8000	7500	8000	5500	6000	ohms
Total Harmonic Distortion	2	1.5	2	2	4	per cent
Maximum-Signal Power Output	12.5	20	24	15	17	watts

MAXIMUM CIRCUIT VALUES

Grid-No.1-Circuit Resistance:		
For fixed-bias operation	0.5	megohm
For cathode-bias operation	1	megohm

Push-Pull Class AB₁ Amplifier

Grid No.2 of Each Tube Connected to Tap on Plate Winding of Output Transformer

MAXIMUM RATINGS (Design-Maximum Values)

Plate and Grid-No.2 Supply Voltage	410	volts
Plate Dissipation	12	watts
Grid-No.2 Input	1.75	watts
Bulb Temperature (At hottest point)	250	°C

TYPICAL OPERATION (Values are for two tubes)

	Fixed Bias	Cathode Bias	
Plate Supply Voltage	375	370	volts
Grid-No.2 Supply Voltage	*	#	volts
Grid-No.1 Voltage*	-33.5	-	volts
Cathode-Bias Resistor	-	355	ohms
Peak AF Grid-No.1-to-Grid-No.1 Voltage	67	62	volts
Zero-Signal Cathode Current	62	74	mA
Maximum-Signal Cathode Current	95	84	mA
Effective Load Resistance (Plate-to-plate)	12500	13000	ohms
Total Harmonic Distortion	1.5	1.2	per cent
Maximum-Signal Power Output	18.5	15	watts

MAXIMUM CIRCUIT VALUES

Grid-No.1-Circuit Resistance:		
For fixed-bias operation	0.1	megohm
For cathode-bias operation	1	megohm

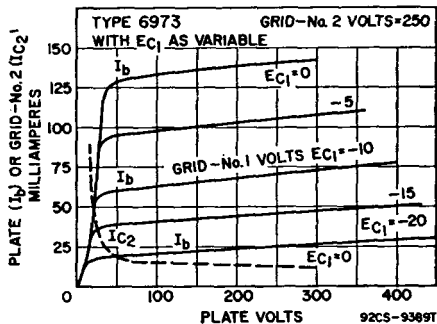
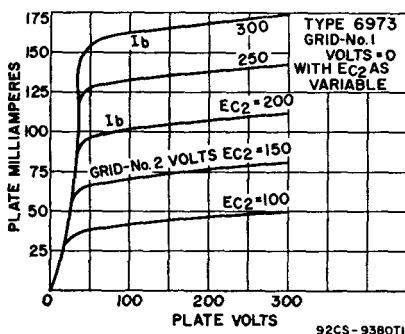

* Obtained from taps on the primary winding of the output transformer. The taps are located on each side of the center tap (B+) so as to apply 50 per cent of the plate signal voltage to grid No.2 of each output tube.

Obtained from taps on the primary winding of the output transformer. The taps are located on each side of the center tap (B+) so as to supply 43 per cent of the plate signal voltage to grid No.2 of each output tube.

* The type of input-coupling network used should not introduce too much resistance in the grid-No.1 circuit. Transformer- or impedance-coupling devices are recommended.

6977

Refer to chart at end of section.

7025

HIGH-MU TWIN TRIODE

Miniature type used as phase inverter or resistance-coupled amplifier in high-quality, high-fidelity audio amplifiers. Outlines section, 6B; requires miniature 9-contact socket. This type is identical with miniature type 12AX7A except that it has a controlled equivalent noise and hum characteristic. For operation as resistance-coupled amplifier, refer to Resistance-Coupled Amplifier section.

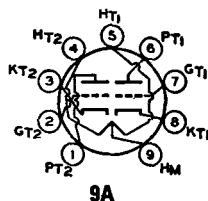

EQUIVALENT-NOISE AND HUM VOLTAGE REFERENCED TO GRID (Each Unit)

Average Value (rms) †	1.8	μV
Maximum Value (rms) •	7	μV

† Measured in "true rms" units under following conditions: heater volts (ac), 6.3 (parallel connection); center tap of heater transformer connected to ground; plate supply volts, 250; plate load resistor, 2700 ohms; cathode-bypass capacitor, 100 μF; grid resistor, 0 ohms; and amplifier covering frequency range between 25 to 10000 cycles per second.

• Same conditions as for "Average Value" except cathode resistor is unbypassed and grid resistor is 0.05 megohm.

Refer to chart at end of section.

7027

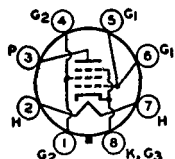

8HY

BEAM POWER TUBE

7027A

Glass octal type used in push-pull power amplifier circuits of high-fidelity audio equipment. Outlines section, 9F; requires octal socket. This tube, like other power-handling tubes, should be adequately ventilated.

Heater Voltage (ac/dc)	6.3	volts
Heater Current	0.9	ampere
Heater-Cathode Voltage:		
Peak value	±200 max	volts
Average value	100 max	volts
Direct Interelectrode Capacitances (Approx.):		
Grid No.1 to Plate	1.5	pF
Grid No.1 to Cathode, Heater, Grid No.2, and Grid No.3	10	pF
Plate to Cathode, Heater, Grid No.2, and Grid No.3	7.5	pF

Class A₁ Amplifier

CHARACTERISTICS

Plate Voltage	250	volts
Grid-No.2 (Screen-Grid) Voltage	250	volts
Grid-No.1 (Control-Grid) Voltage	-14	volts
Plate Resistance (Approx.)	22500	ohms
Transconductance	6000	μmbos
Plate Current	72	mA
Grid-No.2 Current	5	mA

Push-Pull Class AB₁ Amplifier

MAXIMUM RATINGS (Design-Maximum Values)

Plate Voltage	600	volts
Grid-No.2 Voltage	500	volts
Plate Dissipation	35	watts
Grid-No.2 Input	5	watts

TYPICAL OPERATION (Values are for two tubes)

	Fixed Bias			Cathode Bias			
Plate Supply Voltage	400	450	540	400	380	425	volts
Grid-No.2 Supply Voltage	300	350	400	300	380	415	volts
Grid-No.1 Voltage	-25•	-30•	-38•	—	—	—	volts
Cathode-Bias Resistor	—	—	—	200	180	200	ohms
Peak AF Grid-No.1-to-Grid-No.1 Voltage	50	60	76	57	68.5	86	volts
Zero-Signal Plate Current	102	95	100	112	138	150	mA
Maximum-Signal Plate Current	152	194	220	128	170	196	mA
Zero-Signal Grid-No.2 Current	6	3.4	5	7	5.6	8	mA
Maximum-Signal Grid-No.2 Current	17	19.2	21.4	16	20	20	mA
Effective Load Resistance (Plate-to-plate)	6600	6000	6500	6600	4500	3800	ohms
Total Harmonic Distortion	2	1.5	2	2	3.5	4	per cent
Maximum-Signal Power Output	34	50	76	32	36	44	watts

MAXIMUM CIRCUIT VALUES

Grid-No.1-Circuit Resistance:		
For fixed-bias operation*	0.1	megohm
For cathode-bias operation	0.5	megohm

* The type of input coupling network used should not introduce too much resistance in the grid-No.1 circuit. Transformer- or impedance-coupling devices are recommended.

Push-Pull Class AB₁ Amplifier

Grid No.2 of Each Tube Connected to Tap on Plate Winding of Output Transformer

MAXIMUM RATINGS (Design-Maximum Values)

Plate and Grid-No.2 Supply Voltage	600	vols
Plate Dissipation	35	watts
Grid-No.2 Input	4.5	watts

TYPICAL OPERATION (Values are for two tubes)

Plate Supply Voltage	410	vols
Grid-No.2 Supply Voltage	*	vols
Cathode-Bias Resistor	220	ohms
Peak AF Grid-No.1-to-Grid-No.1 Voltage	68	vols
Zero-Signal Cathode Current	134	mA
Maximum-Signal Cathode Current	155	mA
Effective Load Resistance (Plate to plate)	8000	ohms
Total Harmonic Distortion	1.6	per cent
Maximum-Signal Power Output	24	watts

MAXIMUM CIRCUIT VALUE

Grid-No.1-Circuit Resistance, for cathode-bias operation	0.5	megohm
----------------------------------------------------------	-----	--------

* Obtained from taps on the primary winding of the output transformer. The taps are located on each side of the center tap (B₁) so as to apply 43 per cent of the plate signal voltage to grid No.2 of each output tube.

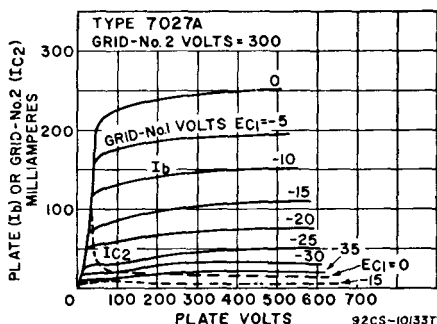
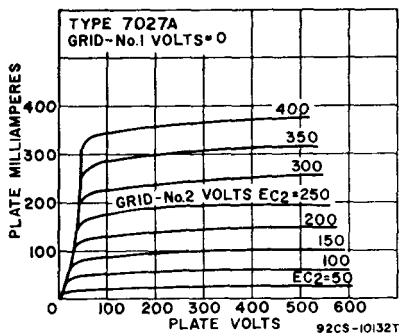

7044

Refer to chart at end of section.

7054

Refer to chart at end of section.

7055

Refer to chart at end of section.

7056

Refer to chart at end of section.

7057

Refer to chart at end of section.

7058

Refer to chart at end of section.

7059

INDUSTRIAL
TYPE

MEDIUM-MU TRIODE— SHARP-CUTOFF PENTODE

Miniature type medium-mu triode sharp-cutoff pentode for use as a combined oscillator and mixer in mobile communications equipment. Outlines section, 6B; requires miniature 9-contact socket.

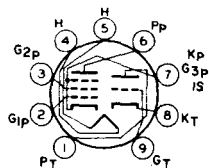

9AE

Heater Voltage Range (ac dc)	12 to 15	vols
Heater Current (Approx.) at 13.5 Volts	0.195	ampere
Peak Heater-Cathode Voltage	±120 max.	vols

Direct Interelectrode Capacitances:

	Unshielded	Shielded	
Triode Unit:			
Grid to Plate	1.7	1.7	pF
Grid to Cathode, Heater	2.7	2.7	pF
Plate to Cathode, Heater	0.4	1	pF
Pentode Unit:			
Grid No.1 to Plate	0.15 max.	0.007 max.	pF
Grid No.1 to Cathode, Heater, Grid No.2, Grid No.3, and Internal Shield	5	5	pF
Plate to Cathode, Heater, Grid No.2, Grid No.3, and Internal Shield	2.5	3.4	pF
Heater to Cathode	3	3	pF

○ With external shield connected to cathode of unit under test except as noted.

■ With external shield connected to ground.

Class A Amplifier

MAXIMUM RATINGS (Design-Maximum Values)

	Triode Unit	Pentode Unit	
Plate Voltage	300	300	volts
Grid-No.2 (Screen-Grid) Supply Voltage	—	300	volts
Grid-No.2 Voltage	—	See curve page 300	
Grid-No.1 (Control-Grid) Voltage, Positive-bias value	0	0	volt
Plate Dissipation	2.5	2.8	watts
Grid-No.2 Input:			
For grid-No.2 voltages up to 150 volts	—	0.5	watt
For grid-No.2 voltages between 150 and 300 volts	—	See curve page 300	

MAXIMUM CIRCUIT VALUES

Grid-No 1-Circuit Resistance:			
For fixed-bias operation	0.5	0.5	megohm
For cathode-bias operation	1	1	megohm

CHARACTERISTICS

Heater Voltage	13.5	13.5	volts
Plate Supply Voltage	150	250	volts
Grid-No.2 Voltage	—	110	volts
Cathode-Bias Resistor	56	68	ohms
Amplification Factor	40	—	
Plate Resistance (Approx.)	4700	400000	ohms
Transconductance	8500	5200	μmhos
Plate Current	18	10	mA
Grid-No.2 Current	—	3.5	mA
Grid-No.1 Voltage for plate current of 10 μA	-12	-10	volts

Special Ratings & Performance Data

HEATER-CYCLING LIFE PERFORMANCE

Cycles of Intermittent Operation	2000 min.	cycles
----------------------------------	-----------	--------

LOW-FREQUENCY VIBRATION PERFORMANCE

RMS Output Voltage, Triode Unit	150 max.	mV
RMS Output Voltage, Pentode Unit	250 max.	mV

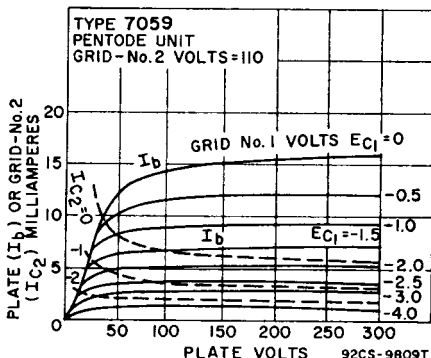
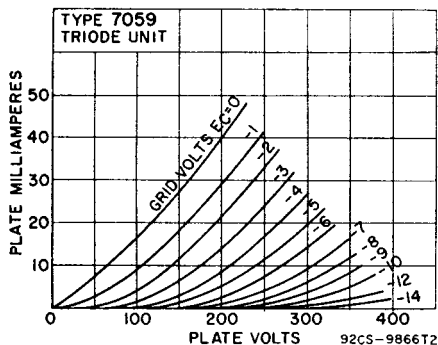

7060 Refer to chart at end of section.

7061 Refer to chart at end of section.

7167 Refer to chart at end of section.

7189 POWER PENTODE

Miniature type used as power amplifier tube in high-fidelity audio equipment. Outlines section, 6G; requires miniature 9-contact socket.

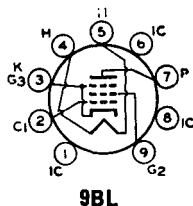

Heater Voltage	6.3	volts
Heater Current	0.76	ampere
Peak Heater-Cathode Voltage	±100 max	volts
Direct Interelectrode Capacitances (Approx.):		
Grid No.1 to Plate	0.5	pF
Grid No.1 to Cathode, Heater, Grid No.2, and Grid No.3	10.8	pF
Plate to Cathode, Heater, Grid-No.2, and Grid No.3	6.5	pF
Grid No.1 to Heater	0.25	pF

Class A₁ Amplifier

CHARACTERISTICS

Plate Voltage	250	volts
Grid-No.2 (Screen-Grid) Voltage	250	volts
Grid-No.1 (Control-Grid) Voltage	-7.3	volts
Mu-Factor, Grid No.2 to Grid No.1	19.5	
Plate Resistance (Approx.)	40000	ohms
Transconductance	11300	μmhos
Plate Current	48	mA
Grid-No.2 Current	5.5	mA

Push-Pull Class AB₁ Amplifier

		Grid-No.2 Special Connection*	
MAXIMUM RATINGS (Design-Center Values)			
Plate Voltage	400	375	volts
Grid-No.2 Voltage	300	•	volts
Cathode Current	65	65	mA
Plate Dissipation	12	12	watts
Zero-Signal Grid-No.2 Input	2	2	watts
Maximum-Signal Grid-No.2 Input	4	4	watts

TYPICAL OPERATION (Values are for two tubes)

Plate Supply Voltage	—	375	volts
Plate Voltage	400	—	volts
Grid-No.2 Supply Voltage	—	•	volts
Grid-No.2 Voltage	300	•	volts
Grid-No.1 Voltage	-15	—	volts
Cathode-Bias Resistor	—	220	ohms
Peak AF Grid-No.1 Voltage	14.8	17.7	volts
Zero-Signal Plate Current	15	70	mA
Maximum-Signal Plate Current	105	81	mA
Zero-Signal Grid-No.2 Current	1.6	•	mA
Maximum-Signal Grid-No.2 Current	25	•	mA
Effective Load Resistance (Plate-to-plate)	8000	11000	ohms
Total Harmonic Distortion	4	3	per cent
Maximum-Signal Power Output	24	16.5	watts

MAXIMUM CIRCUIT VALUES

Grid-No.1-Circuit Resistance	0.3	Fixed Bias	1	Cathode Bias	megohm
------------------------------------	-----	------------	---	--------------	--------

* Grid No.2 of each tube connected to tap on plate winding of output transformer.

• Obtained from taps on primary winding of the output transformer. The taps are located on each side of the center tap (B+) so as to supply 43 per cent of the plate signal voltage to grid No.2 of each output tube.

MEDIUM-MU TRIODE— SHARP-CUTOFF PENTODE 7199

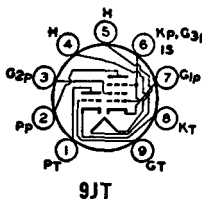

Miniature type used in high-quality, high-fidelity audio equipment, particularly in phase splitters, tone-control amplifiers, and high-gain voltage amplifiers. Outlines section, 6B; requires miniature 9-contact socket. For operation as resistance-coupled amplifier, refer to Resistance-Coupled Amplifier section. In direct-coupled voltage-amplifier phase-splitter circuits, the pentode unit should drive the triode unit.

Heater Voltage (ac/dc)	6.3	volts
Heater Current	0.45	ampere
Heater-Cathode Voltage:		
Peak value	±200 max	volts
Average value	100 max	volts
Direct Interelectrode Capacitances:		
Triode Unit:		
Grid to Plate	2	pF
Grid to Cathode and Heater	2.3	pF
Plate to Cathode and Heater	0.3	pF
Pentode Unit:		
Grid No.1 to Plate	0.06 max	pF
Grid No.1 to Cathode, Heater, Grid No.2, Grid No.3, and Internal Shield	5	pF
Plate to Cathode, Heater, Grid No.2, Grid No.3, and Internal Shield	2	pF

EQUIVALENT-NOISE AND HUM VOLTAGE REFERENCED TO GRID

	Triode Unit	Pentode Unit	
Median Value (rms)	10 [†]	35*	μV
Maximum Value (rms)	150 [†]	100*	μV

[†] Measured in "true rms" units under the following conditions: heater volts (ac), 6.3; center tap of heater transformer connected to ground; plate-supply volts, 250; plate load resistor, 0.1 megohm; cathode resistor, 1500 ohms; grid resistor, 0.05 megohm; and amplifier covering frequency range between 25 and 10000 cycles per second.

* Same conditions as for triode unit except: grid-No.2 supply volts, 250; grid-No.2 resistor, 0.33 megohm; grid-No.2-bypass capacitor, 0.22 μF; cathode resistor, 1200 ohms; and grid-No.1 resistor, 0.05 megohm.

Class A₁ Amplifier

MAXIMUM RATINGS (Design-Maximum Values)

	Triode Unit	Pentode Unit	
Plate Voltage	330	330	volts
Grid-No.2 (Screen-Grid) Voltage	—	See curve page 300	
Grid-No.2 Supply Voltage	0	330	volts
Grid-No.1 (Control-Grid) Voltage, Positive-bias value	—	0	volts
Plate Dissipation	2.4	;	watts
Grid-No.2 Input:			
For grid-No.2 voltages up to 165 volts	—	0.6	watt
For grid-No.2 voltages between 165 and 330 volts	—	See curve page 300	

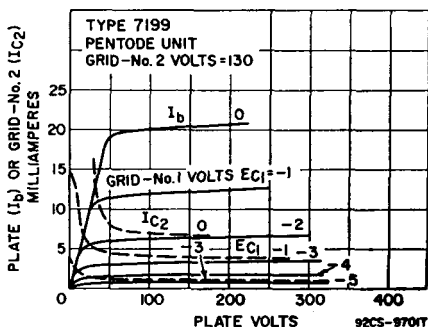
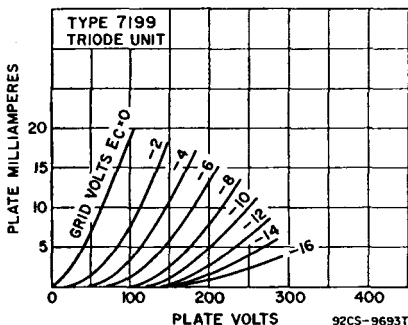

CHARACTERISTICS

	Triode Unit	Pentode Unit		
Plate Supply Voltage	215	100	220	volts
Grid-No.2 Supply Voltage	—	50	130	volts
Grid-No.1 Voltage	-8.5	—	—	volts
Cathode-Bias Resistor	—	1000	62	ohms
Amplification Factor	17	—	—	
Plate Resistance (Approx.)	0.0081	1	0.4	megohm
Transconductance	2100	1500	7000	μmhos
Plate Current	9	1.1	12.5	mA
Grid-No.2 Current	—	0.35	3.5	mA
Grid-No.1 Voltage (Approx.) for plate current of 10 μA	-40	-4	—	volts

MAXIMUM CIRCUIT VALUES

	Triode Unit	Pentode Unit	
Grid-No.1-Circuit Resistance:*			
For fixed-bias operation	0.5	0.25	megohm
For cathode-bias operation	1	1	megohm

* If either unit is operated at maximum rated conditions, grid-No.1-circuit resistance for both units should not exceed the stated value.

7247

DUAL TRIODE

Miniature type used for combined first- and second-stage audio preamplification in high-fidelity phonograph or tape equipment. Tube has high-mu unit and medium-mu unit. Outline 8B, Outlines section. Tube requires miniature nine-contact socket and may be operated in any position. Heater: volts (ac/dc), 12.6 (series), 6.3 (parallel); amperes, 0.15 (series), 0.3 (parallel).

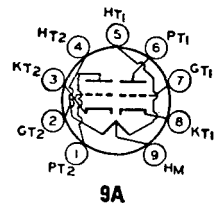

Class A₁ Amplifier

MAXIMUM RATINGS (Design-Maximum Values)

	Unit No.1	Unit No.2	
Plate Voltage	330	330	volts
Grid Voltage:			
Negative-bias value	55	55	volts
Positive-bias value	0	0	volts
Cathode Current	—	22	mA
Plate Dissipation	1.2	3	watts
Heater-Cathode-Voltage:			
Peak value		±200 max	volts
Average value		100 max	volts

CHARACTERISTICS

	Unit No.1		Unit No.2		
Plate Voltage	100	250	100	250	volts
Grid Voltage	-1	-2	0	-8.5	volts
Amplification Factor	100	100	20	17	
Plate Resistance (Approx.)	80000	62500	6500	7700	ohms
Transconductance	1250	1600	3100	2200	μmhos
Plate Current	0.5	1.2	11.8	10.5	mA
Grid Voltage (Approx.) for plate current of 10 μA	—	—	—	-24	volts

MAXIMUM CIRCUIT VALUES

	Unit No.1	Unit No.2	
Grid-Circuit Resistance:			
For fixed-bias operation	15 max	0.5 max	megohms
For cathode-bias operation	—	1 max	megohm

HUM OUTPUT VOLTAGE

Average Value (rms, cathode bypassed)■	1.8	μvolts
Maximum Value (rms, cathode unbypassed)*	7	μvolts

° The dc component must not exceed 100 volts.

■ Measured in "true rms" units under the following conditions: heater volts (ac), 6.3 (parallel connection); center tap of heater transformer connected to ground; dc plate supply volts, 250; plate load resistor, 0.1 megohm; cathode resistor, 2700 ohms; cathode-bypass capacitor, 100 μf; grid resistor, 0 ohms; amplifier covering frequency range of 25 to 10000 cps.

* Same conditions as above, except that cathode resistor is unbypassed and grid resistor is 0.05 megohm.

Refer to chart at end of section.

7258

Refer to chart at end of section.

7308

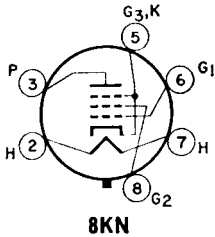

POWER PENTODE

7355

Glass octal type used in the power-output stage of high-fidelity audio-frequency amplifier systems. Outlines section, 13F; requires octal socket. Heater: volts (ac/dc), 6.3; amperes, 0.8; maximum heater-cathode volts, ± 200 peak, 100 average.

Class A₁ Amplifier

MAXIMUM RATINGS (Design-Maximum Values)

Plate Voltage	500	volts
Grid-No.2 (Screen-Grid) Voltage	400	volts
Grid-No.1 (Control-Grid) Voltage, Positive-bias value	0	volts
Average Cathode Current	100	mA
Plate Dissipation	18	watts
DC Grid-No.2 Input	3.5*	volts

TYPICAL OPERATION AND CHARACTERISTICS

Plate Voltage	250	volts
Grid-No.2 Voltage	225	volts
Grid-No.1 Voltage	-15	volts
Peak AF Grid-No.1 Voltage	15	volts
Plate Resistance (Approx.)	42000	ohms
Transconductance	7600	μ mhos
Zero-Signal Plate Current	62	mA
Maximum Signal Plate Current	74	mA
Zero-Signal Grid-No.2 Current	3.2	mA
Maximum-Signal Grid-No.2 Current	16.5	mA
Load Resistance	2500	ohms
Total Harmonic Distortion (Approx.)	15	per cent
Maximum-Signal Power Output	9	watts
Grid-No.1 Voltage (Approx.) for plate current of 500 μ A	-35	volts

MAXIMUM CIRCUIT VALUES

Grid-No.1-Circuit Resistance:		
For fixed-bias operation	0.3	megohm
For cathode-bias operation	1	megohm

* Grid-No.2 input may reach 7 watts during peak levels of speech and music signals.

Push-Pull Class AB₁ Amplifier

MAXIMUM RATINGS (Same as for class A₁ amplifier)

TYPICAL OPERATION (Values are for two tubes)

Plate Voltage	300	400	volts
Grid-No.2 Voltage	250	300	volts
Grid-No.1 Voltage	-21	-34	volts
Peak AF Grid-No.1 Voltage	42	60	volts
Zero-Signal Plate Current	100	56	mA
Maximum-Signal Plate Current	185	175	mA
Zero-Signal Grid-No.2 Current	5.5	3.5	mA
Maximum-Signal Grid-No.2 Current	24	24	mA
Effective Load Resistance (Plate-to-plate)	4000	5000	ohms
Total Harmonic Distortion	2	6	per cent
Maximum-Signal Power Output	28.5	40	watts

Refer to chart at end of section.

7360

7408

BEAM POWER TUBE

Glass octal type used as output amplifier tube in high-quality sound systems. Outlines section, 13D; requires octal socket.

Heater Voltage (ac/dc)	6.3	volts
Heater Current	0.45	ampere
Heater-Cathode Voltage:		
Peak value	± 200	volts
Average value	100	volts
Direct Interelectrode Capacitances:		
Grid No.1 to Plate	0.7	pF
Grid No.1 to Cathode, Heater, Grid No.2, and Grid No.3	9	pF
Plate to Cathode, Heater, Grid No.2, and Grid No.3	7.5	pF

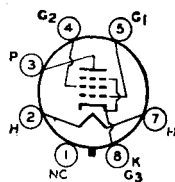

7AC

Class A₁ Amplifier

MAXIMUM RATINGS (Design-Maximum Values)

Plate Voltage	350	volts
Grid-No.2 (Screen-Grid) Voltage	315	volts
Grid-No.2 Input	2.2	watts
Plate Dissipation	14	watts

TYPICAL OPERATION AND CHARACTERISTICS

Plate Voltage	60	250	volts
Grid-No.2 Voltage	250	250	volts
Grid-No.1 (Control-Grid) Voltage	0	-12.5	volts
Peak AF Grid-No.1 Voltage	—	12.5	volts
Zero-Signal Plate Current	100*	45	mA
Maximum-Signal Plate Current	—	47	mA
Zero-Signal Grid-No.2 Current	22*	4.5	mA
Maximum-Signal Grid-No.2 Current	—	7	mA
Plate Resistance (Approx.)	—	50000	ohms
Transconductance	—	4100	μ mhos
Load Resistance	—	5000	ohms
Total Harmonic Distortion	—	7	per cent
Maximum-Signal Power Output	—	4.5	watts

MAXIMUM CIRCUIT VALUES

Grid-No.1-Circuit Resistance:		
For fixed-bias operation	0.1	megohm
For cathode-bias operation	0.5	megohm

* This value can be measured by a method involving a recurrent waveform such that the maximum ratings of the tube will not be exceeded.

7543

SHARP-CUTOFF PENTODE

Miniature type used in compact audio equipment. Outlines section, 5C; requires miniature 7-contact socket. This type is identical with miniature type 6AU6A except that it has a controlled hum characteristic.

HUM OUTPUT VOLTAGE

Average Value, (rms, cathode bypassed)	1.2 [†]	millivolts
Average Value (rms, cathode unbypassed)	0.9*	millivolt

[†] Measured in "true rms" units under the following conditions: heater volts (ac), 6.3; center tap of heater transformer connected to ground; plate and grid-No.2 supply volts, 250; plate load resistor, 0.27 megohm; grid No.3 and internal shield connected to cathode at socket; grid-No.2 resistor, 0.68 megohm; grid-No.1 resistor, 0.1 megohm; cathode resistor, 1000 ohms; grid resistor of following stage, 10 megohms; and stage gain, 340.

* Same conditions as above except that cathode resistor is unbypassed and stage gain is 110.

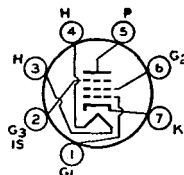

7BK

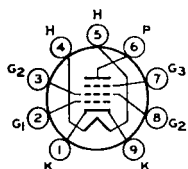

9LK

BEAM POWER TUBE

7551

INDUSTRIAL TYPE

Miniature type for use as a class C radio-frequency amplifier, oscillator, and frequency-multiplier up to 175 MHz in mobile communications equipment. Outlines section, 6E; requires miniature 9-contact socket. Curves shown under type 7558 also apply to the 7551.

Heater Voltage (ac/dc)	13.5 ±1.5	volts
Heater Current	0.36	ampere
Peak Heater-Cathode Voltage	±100 max.	volts
Direct Interelectrode Capacitances:		
Grid No.1 to Plate	0.15 max.	pF
Grid No.1 to Cathode, Grid No.3, Grid No.2 and Heater	10	pF
Plate to Cathode, Grid No.3, Grid No.2 and Heater	5.5	pF
Bulb Temperature (At hottest point on bulb surface)	225 max.	°C

MAXIMUM CIRCUIT VALUE

Grid-No.1-Circuit Resistance—CCS or ICAS operation	0.1	megohm
----------------------------------------------------	-----	--------

Class A₁ Amplifier

CHARACTERISTICS

Heater Voltage	13.5	volts
Plate Voltage	250	volts
Grid No.3	Connected to cathode at socket	
Grid-No.2 Voltage	250	volts
Grid-No.1 Voltage	-18	volts
Mu-Factor, Grid No.2 to Grid No.1	8.7	
Transconductance	5300	μmhos
Plate Current	40	mA
Grid-No.2 Current	3	mA

AF Power Amplifier & Modulator—Class AB₁†

MAXIMUM CCS* RATINGS (Absolute-Maximum Values)

DC Plate Voltage	375	volts
Grid No.3 (Suppressor-Grid)	0	volt
DC Grid-No.2 (Screen-Grid) Voltage	300	volts
Max.-Signal DC Plate Current [‡]	70	mA
Max.-Signal Plate Input [‡]	21	watts
Max.-Signal Grid-No.2 Input [‡]	2	watts
Plate Dissipation [‡]	10	watts

TYPICAL CCS PUSH-PULL OPERATION

Values are for 2 tubes

Heater Voltage	13.5	volts
DC Plate Voltage	300	volts
Grid No.3	Connected to cathode at socket	
DC Grid-No.2 Voltage§	250	volts
DC Grid-No.1 Voltage§	-21	volts
Peak AF Grid-No.1-to-Grid-No.1 Voltage	40	volts
Zero-Signal DC Plate Current	40	mA
Max.-Signal DC Plate Current	125	mA
Zero-Signal DC Grid-No.2 Current	2	mA
Max.-Signal DC Grid-No.2 Current	14	mA
Effective Load Resistance (Plate to plate)	5000	ohms
Max.-Signal Driving Power	0	watts
Total Harmonic Distortion	5	%
Max.-Signal Power Output (Approx.)	20.5	watts

RF Power Amplifier & Oscillator—Class C Telegraphy†
and
RF Power Amplifier—Class C FM Telephony

MAXIMUM RATINGS (Absolute-Maximum Values)

	Up to 175 MHz		
	CCS*	ICAS**	
DC Plate Voltage	375	375	volts
Grid No.3 (Suppressor Grid)	0	0	volt

DC Grid-No.2 (Screen-Grid) Voltage	300	300	volts
DC Grid-No.1 (Control-Grid) Voltage	-125	-125	volts
DC Plate Current	70	80	mA
DC Grid-No.2 Current	15	15	mA
DC Grid-No.1 Current	5	5	mA
Plate Input	21	24	watts
Grid-No.2 Input	2	2	watts
Plate Dissipation	10	12	watts

TYPICAL OPERATION

As amplifier at 175 MHz

	CCS●	ICAS●●	
Heater Voltage	13.5	13.5	volts
DC Plate Voltage	250	300	volts
Grid No.3	Connected to cathode at socket		
DC Grid-No.2 Voltage□	200	250	volts
DC Grid-No.1 Voltage ⊕⊕	-40	-55	volts
Peak RF Grid-No.1 Voltage	47	62	volts
DC Plate Current	60	80	mA
DC Grid-No.2 Current	3.7	5.1	mA
DC Grid-No.1 Current (Approx.)	1.5	1.6	mA
Driver Power Output (Approx.)▲▲	1	1.5	watts
Useful Power Output (Approx.)*	6.5	10	watts

Plate-Modulated RF Power Amplifier—Class C Telephony

Carrier conditions per tube for use with a maximum modulation factor of 1

MAXIMUM RATINGS (Absolute-Maximum Values)

	Up to 175 MHz CCS●	ICAS●●	
DC Plate Voltage	300	300	volts
Grid No.3 (Suppressor Grid)	0	0	volt
DC Grid-No.2 (Screen-Grid) Voltage	300	300	volts
DC Grid-No.1 (Control-Grid) Voltage	-125	-125	volts
DC Plate Current	60	70	mA
DC Grid-No.2 Current	10	10	mA
DC Grid-No.1 Current	5	5	mA
Plate Input	15	17.5	watts
Grid-No.2 Input	1.4	1.4	watts
Plate Dissipation	7	8	watts

TYPICAL OPERATION

At 175 MHz

	CCS●	ICAS●●	
Heater Voltage	13.5	13.5	volts
DC Plate Voltage	250	250	volts
Grid No.3	Connected to cathode at socket		
DC Grid-No.2 Voltage▲	250	250	volts
DC Grid-No.1 Voltage*	-70	-75	volts
From a grid-No.1 resistor of	33000	33000	ohms
RF Grid-No.1 Voltage	75	80	volts
DC Plate Current	60	70	mA
DC Grid-No.2 Current	2.5	3	mA
DC Grid-No.1 Current (Approx.)	2.1	2.3	mA
Driving Power (Approx.)▲▲	1	1	watt
Useful Power Output*	6.5	7.5	watts

Frequency Multiplier**MAXIMUM RATINGS (Absolute-Maximum Values)**

	CCS●	ICAS●●	
DC Plate Voltage	375	375	volts
Grid No.3 (Suppressor Grid)	0	0	volt
DC Grid-No.2 (Screen-Grid) Voltage	300	300	volts
DC Grid-No.1 (Control-Grid) Voltage	-125	-125	volts
DC Plate Current	50	60	mA
DC Grid-No.2 Current	15	15	mA
DC Grid-No.1 Current	5	5	mA
Plate Input	13	15	watts
Grid-No.2 Input	2	2	watts
Plate Dissipation	10	12	watts

TYPICAL OPERATION

As doubler to 175 MHz

	CCS●	ICAS●●	
Heater Voltage	13.5	13.5	volts
DC Plate Voltage	250	250	volts
Grid No.3	Connected to cathode at socket		
DC Grid-No.2 Voltage	200	250	volts
DC Grid-No.1 Voltage⊕⊕	-53	-66	volts
From a grid-No.1 resistor of	53000	44000	ohms
Peak RF Grid-No.1 Voltage	60	74	volts

DC Plate Current	50	60	mA
DC Grid-No.2 Current	2.6	3.5	mA
DC Grid-No.1 Current (Approx.)	1	1.5	mA
Driving Power (Approx.) ^{▲▲}	0.4	0.6	watt
Useful Power Output*	3	4.5	watts

As tripler to 175 MHz

Heater Voltage	13.5	13.5	volts
DC Plate Voltage	200	250	volts
Grid No.3	Connected	to cathode	at socket
DC Grid No.2 Voltage	200	250	volts
DC Grid-No.1 Voltage ^{⊕⊕}	-90	-120	volts
From a grid-No.1 resistor of	50000	70000	ohms
Peak RF Grid-No.1 Voltage	105	130	volts
DC Plate Current	50	60	mA
DC Grid-No.2 Current	3	3.9	mA
DC Grid-No.1 Current (Approx.)	1.85	1.7	mA
Driving Power (Approx.) ^{▲▲}	0.4	0.6	watt
Useful Power Output*	1.4	2.3	watts

♦ Subscript 1 indicates that grid-No.1 current does not flow during any part of the input cycle.

● Continuous Commercial Service.

●● Intermittent Commercial and Amateur Service.

■ Averaged over any audio-frequency cycle of sine-wave form.

† Key-down conditions per tube without amplitude modulation. Amplitude modulation essentially negative may be used if the positive peak of the audio-frequency envelope does not exceed 115% of the carrier conditions.

§ Obtained preferably from a fixed supply.

□ Obtained preferably from a separate source or from the plate-voltage supply with a voltage divider. If a series resistor is used, it should be adjustable to obtain the desired operating plate current after initial tuning adjustments are completed.

⊕⊕ Obtained from a grid-No.1 resistor or from a combination of grid-No.1 resistor with either fixed supply or cathode resistor.

▲▲ Driver stage is required to supply tube losses and rf-circuit losses. The driver stage should be designed to provide an excess of power above the indicated values to take care of variations in line voltage, components, initial tube characteristics, and tube characteristics during life.

* Measured at load.

▲ Obtained preferably from a separate source modulated along with the plate supply, or from the modulated plate supply through a series resistor. It is recommended that this resistor be adjustable to obtain the desired operating plate current after initial tuning adjustments are made.

* Obtained from a grid-No.1 resistor or from a combination of grid-No.1 resistor with either fixed supply or cathode resistor. The combination of grid-No.1 resistor and fixed supply has the advantage of not only protecting the tube from damage through loss of excitation but also of minimizing distortion by bias-supply compensation.

Special Ratings & Performance Data

HEATER-CYCLING LIFE PERFORMANCE

Cycles of Intermittent Operation	2000 min.	cycles
----------------------------------------	-----------	--------

LOW-FREQUENCY VIBRATION PERFORMANCE

RMS Output Voltage	200 max.	mV
--------------------------	----------	----

BEAM POWER TUBE

7558

INDUSTRIAL TYPE

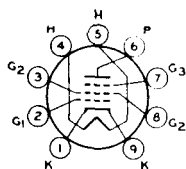

9LK

Miniature type for use as a class C radio-frequency amplifier, oscillator, and frequency-multiplier up to 175 MHz in mobile communications equipment. Outlines section, 6E; requires miniature 9-contact socket. This type is identical with type 7551 except for heater voltage and current. Special ratings and performance data for the 7551 do not apply to the 7558.

Heater Voltage	6.3 ±5%	volts
Heater Current	0.8	ampere

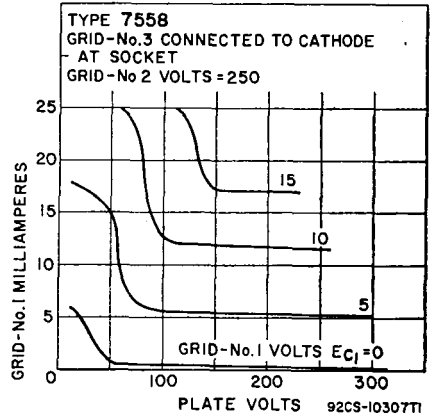
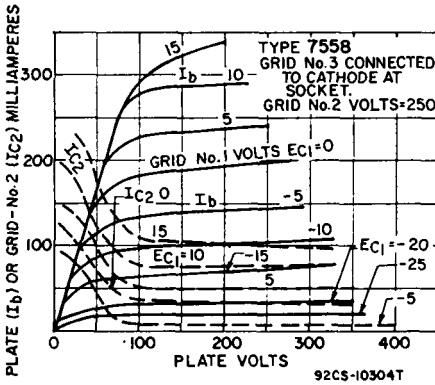

7581A BEAM POWER TUBE

Glass octal type used in af power-amplifier applications. Outlines section, 19D; requires octal socket. For typical operation as push-pull class A₁, class AB₁, and class AB₂ amplifier, refer to type 6L6GC. This tube, like other power-handling tubes, should be adequately ventilated. Heater: volts (ac/dc), 6.3; amperes, 0.9; maximum heater-cathode volts, ±200.

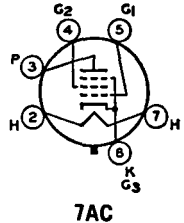

Class A₁ Amplifier

MAXIMUM RATINGS (Design-Maximum Values)

Plate Voltage	450
Grid-No.2 (Screen-Grid) Voltage	—
Plate Dissipation	35
Grid-No.2 Input	—

Triode Connection*

Pentode Connection

500	volts
450#	volts
35	watts
5	watts

MAXIMUM CIRCUIT VALUES

Grid-No.1-Circuit Resistance:	
For fixed-bias operation	0.1
For cathode-bias operation	0.5

0.1	megohm
0.5	megohm

Class A₁ Amplifier (Pentode Connection)

MAXIMUM RATINGS (Same as for Class A₁ Amplifier)

TYPICAL OPERATION

Plate Voltage	70
Grid-No.2 Voltage	300
Grid-No.1 Voltage	0 [▲]
Plate Resistance (Approx.)	—
Transconductance	—
Plate Current	210
Grid-No.2 Current	25
Load Resistance	—
Total Harmonic Distortion	—
Maximum-Signal Power Output	—

250	volts
250	volts
—14	volts
22500	ohms
6000	μmhos
72	mA
5	mA
2500	ohms
10	per cent
6.5	watts

Class A₁ Amplifier (Triode Connection)

MAXIMUM RATINGS (Same as for Class A₁ Amplifier)

TYPICAL OPERATION

Plate Voltage	250
Grid-No.1 Voltage	—20
Peak AF Grid-No.1 Voltage	20

250	volts
—20	volts
20	volts

Amplification Factor	8	
Plate Resistance (Approx.)	1700	ohms
Transconductance	4700	μ mhos
Zero-Signal Plate Current	40	mA
Maximum-Signal Plate Current	44	mA
Load Resistance	5000	ohms
Total Harmonic Distortion (Approx.)	5	per cent
Maximum-Signal Power Output	1.4	watts

* Grid No.2 connected to plate.

In push-pull circuits where grid No.2 of each tube is connected to a tap on the plate winding of the output transformer, this maximum rating is 500 volts.

▲ Applied for short interval (2 seconds) so as not to damage tube.

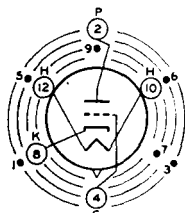

12AQ
INDEX = LARGE LUG
● = SHORT PIN - IC

MEDIUM-MU TRIODE

7586
INDUSTRIAL
TYPE

Nuvistor type, medium-mu general purpose triode for use as an amplifier or oscillator at frequencies extending into the UHF region. Outlines section, 1; requires nuvistor socket.

Heater Voltage (ac/dc)	6.3 \pm 0.6	volts
Heater Current	0.135	ampere
Peak Heater-Cathode Voltage	\pm 100 max.	volts
Direct Interelectrode Capacitance (Approx.):		
Grid to Plate	2.2	pF
Grid to Cathode, Heater, and Shell	4.2	pF
Plate to Cathode, Heater, and Shell	1.6	pF
Plate to Cathode	0.26	pF
Heater to Cathode	1.4	pF

Industrial Service

MAXIMUM RATINGS (Absolute-Maximum Values)

For operation at any altitude

Plate Supply Voltage	330	volts
Plate Voltage	110	volts
Grid Voltage:		
Negative-bias value	55	volts
Peak-positive value	4	volts
Grid Current	2	mA
Cathode Current	15	mA
Plate Dissipation	1	watt

MAXIMUM CIRCUIT VALUES

Grid-Circuit Resistance:*		
For fixed-bias operation	0.5	megohm
For cathode-bias operation	1	megohm

* For operation at metal-shell temperature of 150°C. For operation at other metal-shell temperatures, see Grid-Circuit Resistance Rating Chart.

Class A₁ Amplifier

CHARACTERISTICS

Plate Supply Voltage	—	—	75	volts
Plate Voltage	26.5	40	—	volts
Grid Supply Voltage	0	0	0	volt
Cathode Resistor	—	—	100	ohms
Amplification Factor	31	35	35	
Grid Resistor	0.5	.5	—	megohm
Plate Resistance (Approx.)	4400	3000	3000	ohms
Transconductance	7000	11500	11500	μ mhos
Plate Current	2.8	7.5	10.5	mA
Grid Voltage (Approx.) for plate μ A = 10	—	—	—7	volts

Special Ratings & Performance Data

SHOCK RATING

Peak Impact Acceleration 1000 max. g

FATIGUE RATING

Peak Vibrational Acceleration 2.5 max. g

GRID-CIRCUIT-RESISTANCE RATING CHART

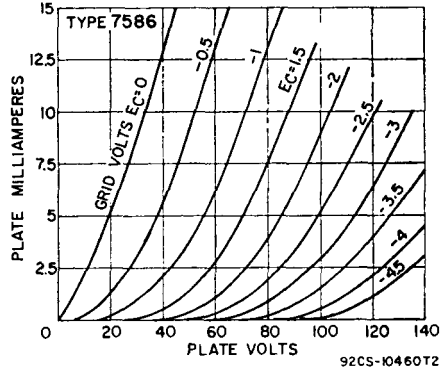
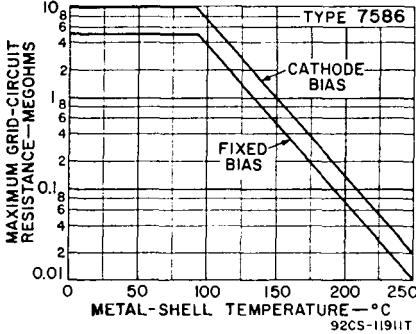

7587
INDUSTRIAL TYPE

SHARP-CUTOFF TETRODE

Nuvistor type sharp-cutoff general-purpose tetrode for use in a wide variety of industrial applications. Outlines section, 1A1; requires nuvistor socket.

Heater Voltage (ac/dc)	6.3 ± 0.6	volts
Heater Current	0.150	ampere
Peak Heater-Cathode Voltage	±100 max.	volts
Direct Interelectrode Capacitances:		
Grid No.1 to Plate	0.015 max.	pF
Grid No.1 to Cathode, Grid No.2, Shell, and Heater	7.0	pF
Plate to Cathode, Grid No.2, Shell, and Heater	1.4	pF
Heater to Cathode	1.4	pF

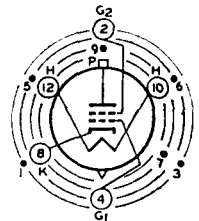

INDEX = LARGE LUG
• = SHORT PIN-IC

12AS

6.3 ± 0.6	volts
0.150	ampere
±100 max.	volts
0.015 max.	pF
7.0	pF
1.4	pF
1.4	pF

Industrial Service

MAXIMUM RATINGS (Absolute-Maximum Values)
For operation at any altitude

Plate Supply Voltage	330	volts
Plate Voltage	250	volts
Grid-No.2 (Screen-Grid) Supply Voltage	330	volts
Grid-No.2 Voltage	110	volts
Grid-No.1 (Control-Grid) Voltage:		
Negative-bias value	55	volts
Peak-positive value	2	volts
Cathode Current	20	mA
Grid-No.1 Current	2	mA
Grid-No.2 Input	0.2	watt
Plate Dissipation	2.2	watts

MAXIMUM CIRCUIT VALUES

Grid-Circuit Resistance:•		
For fixed-bias operation	0.5	megohm
For cathode-bias operation	1	megohm

• For operation at metal-shell temperature up to 150°C.

Class A₁ Amplifier

CHARACTERISTICS

Plate Supply Voltage	125	volts
Grid-No.2 Supply Voltage	50	volts
Cathode Resistor	68	ohms
Plate Resistance (Approx.)	0.2	megohm
Transconductance	10600	μ mhos
Plate Current	10	mA
Grid-No.2 Current	2.7	mA
Grid-No.1 Voltage (Approx.) for plate $\mu A = 10$	-4.5	volts

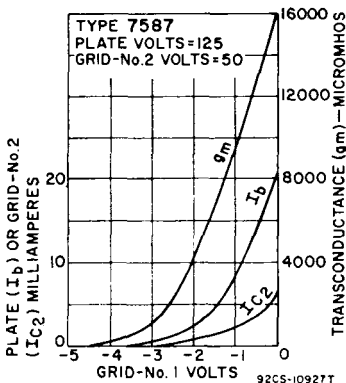

Special Ratings & Performance Data

SHOCK RATING

Impact Acceleration	1000 max.	g
---------------------------	-----------	---

FATIGUE RATING

Vibrational Acceleration	2.5 max.	g
--------------------------------	----------	---

Refer to chart at end of section.

7591

POWER PENTODE

7591A

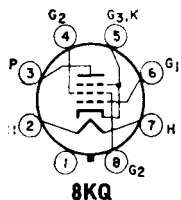

Glass octal type used as audio-frequency power-output tube in high-quality audio applications. Outlines section, 13D; requires octal socket. Heater: volts (ac/dc), 6.3; amperes, 0.8; maximum heater-cathode volts, ± 200 peak, 100 average.

Class A₁ Amplifier

MAXIMUM RATINGS (Design-Maximum Values)

Plate Voltage	550	volts
Grid-No.2 (Screen-Grid) Voltage	440	volts
Cathode Current	90	mA
Plate Dissipation	19	watts
Grid-No.2 Input	3.3*	watts

TYPICAL OPERATION AND CHARACTERISTICS

Plate Voltage	300	volts
Grid-No.2 Voltage	300	volts
Grid-No.1 (Control-Grid) Voltage	-10	volts
Peak AF Grid-No.1 Voltage	10	volts
Zero-Signal Plate Current	60	mA
Maximum-Signal Plate Current	75	mA
Zero-Signal Grid-No.2 Current	8	mA

Maximum-Signal Grid-No.2 Current	15	mA
Triode Amplification Factor°	16.8	
Plate Resistance (Approx.)	29000	ohms
Transconductance	10200	μmhos
Load Resistance	3000	ohms
Total Harmonic Distortion	13	per cent
Maximum-Signal Power Output	11	watts

MAXIMUM CIRCUIT VALUES

Grid-No.1-Circuit Resistance:		
For fixed-bias operation	0.3	megohm
For cathode-bias operation	1	megohm

* Grid-No.2 input may reach 6 watts during peak levels of speech and music signals.

* Triode connection, grid No.2 connected to plate.

Push-Pull Class AB₁ Amplifier**MAXIMUM RATINGS (Same as for Class A₁ Amplifier)**

TYPICAL OPERATION (Values are for two tubes)	Fixed Bias		Cathode Bias	
Plate Supply Voltage	350	450	450	volts
Grid-No.2 Supply Voltage	350	400	400	volts
Grid-No.1 Supply Voltage	-15.5	-21	—	volts
Cathode-Bias Resistor				
(Common to both cathodes)	—	—	200	ohms
Peak AF Grid-No.1-to-Grid-No.1 Voltage	31	42	28	volts
Zero-Signal Plate Current	92	66	82	mA
Maximum-Signal Plate Current	130	144	94	mA
Zero-Signal Grid-No.2 Current	13	9.4	11.5	mA
Maximum-Signal Grid-No.2 Current	28.6	30	22	mA
Effective Load Resistance (Plate-to-plate)	6600	6600	9000	ohms
Total Harmonic Distortion	2	1.5	2	per cent
Maximum-Signal Power Output	30	45	28	watts

7695

Refer to chart at end of section.

7717/6CY5

Refer to chart at end of section.

7724/14GT8

Refer to chart at end of section.

7788

Refer to chart at end of section.

7868**POWER PENTODE**

Novar type used in output stages of high-fidelity audio amplifiers and radio receivers. Outlines section, 11C or 30D; requires novar 9-contact socket. This tube, like other power-handling tubes, should be adequately ventilated.

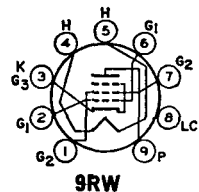

Heater Voltage (ac/dc)	6.3	volts
Heater Current	0.8	ampere
Heater-Cathode Voltage:		
Peak value	±200 max	volts
Average value	100 max	volts
Direct Interelectrode Capacitances (Approx.):		
Grid No.1 to Plate	0.15	pF
Grid No.1 to Cathode, Heater, Grid No.2, and Grid No.3	11	pF
Plate to Cathode, Heater, Grid No.2, and Grid No.3	4.4	pF

Class A₁ Amplifier**MAXIMUM RATINGS (Design-Maximum Values)**

Plate Voltage	550*	volts
Grid-No.2 (Screen-Grid) Voltage	440	volts
Average Cathode Current	90	mA
Plate Dissipation	19	watts
Grid-No.2 Input	3.3*	watts
Bulb Temperature (At hottest point)	240	°C

TYPICAL OPERATION AND CHARACTERISTICS

Plate Supply Voltage	300	volts
Grid-No.2 Voltage	300	volts
Grid-No.1 (Control-Grid) Voltage	-10	volts
Peak AF Grid-No.1 Voltage	10	volts
Zero-Signal Plate Current	60	mA
Maximum-Signal Plate Current	75	mA
Zero-Signal Grid-No.2 Current	8	mA
Maximum-Signal Grid-No.2 Current	15	mA
Plate Resistance (Approx.)	29000	ohms
Transconductance	10200	μ mhos
Effective Load Resistance	3000	ohms
Total Harmonic Distortion	13	per cent
Maximum-Signal Power Output	11	watts

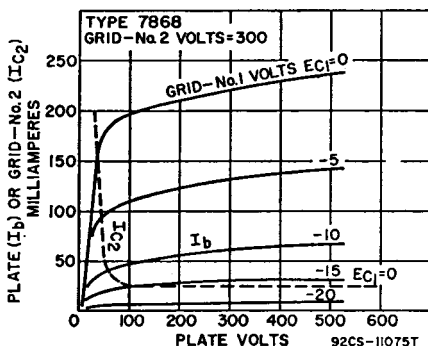

MAXIMUM CIRCUIT VALUES

Grid-No.1-Circuit Resistance:		
For fixed-bias operation	0.3	megohm
For cathode-bias operation	1	megohm

- In push-pull circuits where the grid No.2 of each tube is connected to a tap on the plate winding of the output transformer, this maximum rating is 440 volts.
- Grid No.2 input may reach 6 watts during peak levels of speech and music signals.

Push-Pull Class AB₁ Amplifier

MAXIMUM RATINGS (Same as for class A₁ amplifier)

TYPICAL OPERATION (Values are for two tubes)

	Fixed Bias				Cathode Bias		
Plate Supply Voltage	300	350	400	450	450	450	volts
Grid-No.2 Supply Voltage	300	350	350	350	400	400	volts
Grid-No.1 Voltage	-12.5	-15.5	-16	-16.5	-21	—	volts
Cathode-Bias Resistor (Common to both cathodes)	—	—	—	—	—	170	ohms
Peak AF Grid-No.1-to-Grid-No.1 Voltage	25	31	32	33	42	31	volts
Zero-Signal Plate Current	14	72	64	60	40	86	mA
Maximum-Signal Plate Current	116	130	135	142	145	94	mA
Zero-Signal Grid-No.2 Current	10	9.5	8	7.2	5	10	mA
Maximum-Signal Grid-No.2 Current	28	32	28	26	30	20	mA
Effective Load Resistance (Plate-to-plate)	6600	6600	6600	6600	6600	10000	ohms
Total Harmonic Distortion	5	2.5	2	2.5	5	2	per cent
Maximum-Signal Power Output	24	30	34	38	44	28	watts

Push-Pull Class AB₁ Amplifier

Grid No.2 of Each Tube Connected to Tap on Plate Winding of Output Transformer*

MAXIMUM RATINGS (Same as for class A₁ amplifier)

TYPICAL OPERATION (Values are for two tubes)

	Fixed Bias	Cathode Bias	
Plate Supply Voltage	400	425	volts
Grid-No.2 Supply Voltage	*	*	volts
Grid-No.1 Voltage	-20.5	—	volts
Cathode-Bias Resistor (Common to both cathodes)	—	185	ohms

Peak AF Grid-No.1-to-Grid-No.1 Voltage	41	42	volts
Zero-Signal Plate Current	60	88	mA
Maximum-Signal Plate Current	115	100	mA
Zero-Signal Grid-No.2 Current	8	12	mA
Maximum-Signal Grid-No.2 Current	18	16	mA
Effective Load Resistance (Plate-to-plate)	6600	6600	ohms
Total Harmonic Distortion	2.5	3.5	per cent
Maximum-Signal Power Output	23	21	watts

* Grid No.2 supply voltage is obtained from taps on the primary winding of the output transformer. The taps are located on each side of the center tap (B+) so as to apply 50 per cent of the plate signal voltage to the grid No.2 of each output tube.

7895

INDUSTRIAL
TYPE

HIGH-MU TRIODE

Nuvistor type high-mu triode for use in a wide variety of industrial applications. Outlines section, 1; requires nuvistor socket.

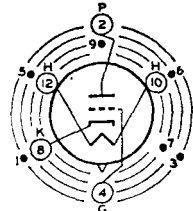

INDEX=LARGE LUG
●=SHORT PIN—IC

12AQ

Heater Voltage (ac/dc)	6.3 ±10%	volts
Heater Current	0.135	ampere
Peak Heater-Cathode Voltage	±100 max.	volts
Direct Interelectrode Capacitances (Approx.):		
Grid to Plate	0.9	pF
Grid to Cathode, Shell, and Heater	4.2	pF
Plate to Cathode, Shell, and Heater	1.7	pF
Plate to Cathode	0.22	pF
Heater to Cathode	1.3	pF

Industrial Service

MAXIMUM RATINGS (Absolute-Maximum Values)

For operation at any altitude

Plate Supply Voltage	330	volts
Plate Voltage	110	volts
Grid Voltage:		
Negative-bias value	55	volts
Peak-positive value	2	volts
Grid Current	2	mA
Plate Current	20	mA
Cathode Current	15	mA
Plate Dissipation	1	watt

MAXIMUM CIRCUIT VALUES

Grid-Circuit Resistance:*		
For fixed-bias operation	0.5	megohm
For cathode-bias operation	1	megohm

* For operation at metal-shell temperature up to 150°C.

Class A₁ Amplifier

CHARACTERISTICS

Plate Supply Voltage	110	volts
Grid Supply Voltage	0	volts
Cathode Resistor	150	ohms
Amplification Factor	64	
Plate Resistance (Approx.)	6800	ohms
Transconductance	9400	μmhos
Plate Current	7	mA
Grid Voltage (Approx.) for plate $\mu A = 10$	-4	volts

Special Ratings & Performance Data

SHOCK RATING		
Impact Acceleration	1000 max.	g
FATIGUE RATING		
Vibrational Acceleration	2.5 max.	g

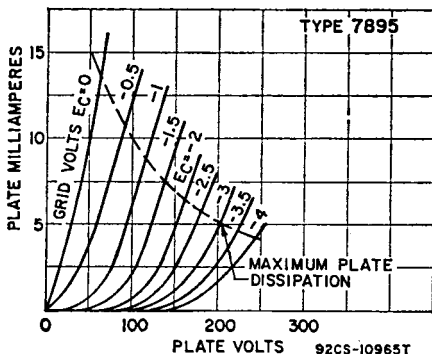

Refer to chart at end of section.

7898

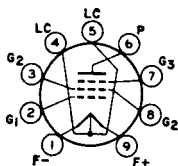

BEAM POWER TUBE

7905

INDUSTRIAL TYPE

Miniature quick-heating-filament beam power tube for use as an RF oscillator, amplifier and frequency multiplier in mobile communications equipment. Outlines section, 6E; requires miniature 9-contact socket.

9PB

Operating Position	Vertical, base up or down, or Horizontal with pins 2 and 8 in vertical plane	
Filament Voltage	6.3 ±10%	volts
Filament Current	0.65	ampere
Heating Time	Less than 1	second
Direct Interelectrode Capacitances:		
Grid No.1 to Plate	0.14 max.	pF
Grid No.1 to Filament, Grid No.3, and Grid No.2	8.5	pF
Plate to Filament, Grid No.3, and Grid No.2	5.5	pF
Bulb Temperature (At hottest point on bulb surface)	225 max.	°C

MAXIMUM CIRCUIT VALUES

Grid-No.1-Circuit Resistance	0.1	megohm
------------------------------	-----	--------

Class A₁ Amplifier

CHARACTERISTICS

Plate Voltage	200	volts
Grid No.3	Connected to pin 1 at socket	
Grid-No.2 Voltage	185	volts
Grid-No.1 Voltage	-6	volts
Mu-Factor, Grid No.2 to Grid No.1	11.5	
Transconductance	6700	μmhos
Plate Current	36	mA
Grid-No.2 Current	2.5	mA

RF Power Amplifier & Oscillator—Class C Telegraphy^a
and

RF Power Amplifier—Class C FM Telephony

MAXIMUM ICAS^b RATINGS (Absolute-Maximum Values)

	Up to 175 MHz	
DC Plate Voltage	300	volts
Grid No.3 (Suppressor Grid)	Connect to pin 1 at socket	
DC Grid-No.2 (Screen-Grid) Supply Voltage	300	volts
DC Grid-No.2 Voltage	250	volts
DC Grid-No.1 (Control-Grid) Voltage	-125	volts
DC Plate Current	60	mA
DC Grid-No.2 Current	10	mA

DC Grid-No.1 Current	5	mA
Plate Input	18	watts
Grid-No.2 Input	1.5	watts
Plate Dissipation	10	watts

TYPICAL ICAS^b OPERATION^c

As amplifier at 175 MHz

DC Plate Voltage	300	300	volts
Grid No.3	Connected to pin 1 at socket		
DC Grid-No.2 Voltage ^d	160	185	volts
DC Grid-No.1 Voltage ^e from a grid-No.1 resistor of 18,000 ohms	-36	-39	volts
Peak RF Grid-No.1 Voltage	41	43	volts
DC Plate Current	50	60	mA
DC Grid-No.2 Current	2.5	4	mA
DC Grid-No.1 Current (Approx.)	2	2.2	mA
Driving Power ^f (Approx.)	1	1	watt
Useful Power Output ^g (Approx.)	5.5	7	watts

Plate-Modulated RF Power Amplifier—Class C Telephony

Carrier conditions per tube for use with a maximum modulation factor of 1

MAXIMUM ICAS^b RATINGS (Absolute-Maximum Values)

	Up to 175 MHz		
DC Plate Voltage	250		volts
Grid No.3	Connected to pin 1 at socket		
DC Grid-No.2 Voltage	250		volts
DC Grid-No.1 Voltage	-125		volts
DC Plate Current	60		mA
DC Grid-No.2 Current	10		mA
DC Grid-No.1 Current	5		mA
Plate Input	15		watts
Grid-No.2 Input	1.4		watts
Plate Dissipation	7		watts

TYPICAL ICAS^b OPERATION^c

At 175 MHz

DC Plate Voltage	250	volts
Grid No.3	Connected to pin 1 at socket	
DC Grid-No.2 Voltage ^b	250	volts
DC Grid-No.1 Voltage ^e from a grid-No.1 resistor of 33,000 ohms	-70	volts
Peak RF Grid-No.1 Voltage	75	volts
DC Plate Current	60	mA
DC Grid-No.2 Current	2.5	mA
DC Grid-No.1 Current (Approx.)	2.1	mA
Driving Power ^f (Approx.)	1	watt
Useful Power Output ^g (Approx.)	6.5	watts

Frequency Multiplier**MAXIMUM ICAS^b RATINGS (Absolute-Maximum Values)**

DC Plate Voltage	300	volts
Grid No.3	Connected to pin 1 at socket	
DC Grid-No.2 Supply Voltage	300	volts
DC Grid-No.2 Voltage	250	volts
DC Grid-No.1 Voltage	-125	volts
DC Plate Current	50	mA
DC Grid-No.2 Current	10	mA
DC Grid-No.1 Current	5	mA
Plate Input	15	watts
Grid-No.2 Input	1.5	watts
Plate Dissipation	10	watts

TYPICAL ICAS^b OPERATION^c

As doubler to 175 MHz

DC Plate Voltage	250	300	volts
Grid No.3	Connected to pin 1 at socket		
DC Grid-No.2 Voltage ^d	200	215	volts
DC Grid-No.1 Voltage ^e from a grid-No.1 resistor of 53,000 ohms	-53	-80	volts
Peak RF Grid-No.1 Voltage	60	87	volts
DC Plate Current	45	50	mA
DC Grid-No.2 Current	3.4	3.4	mA
DC Grid-No.1 Current (Approx.)	1	1.5	mA
Driving Power ^f (Approx.)	0.4	0.5	watt
Useful Power Output ^g (Approx.)	2.5	3.5	watts

As tripler to 175 MHz

DC Plate Voltage	250	250	volts
Grid No.3	Connected to pin 1 at socket		
DC Grid-No.2 Voltage ^d	180	225	volts
DC Grid-No.1 Voltage ^e from a grid-No.1 resistor of:			
50,000 ohms	-90	—	volts
60,000 ohms	—	-108	volts
Peak RF Grid-No.1 Voltage	105	118	volts
DC Plate Current	40	50	mA
DC Grid-No.2 Current	2.5	3.4	mA
DC Grid-No.1 Current (Approx.)	1.8	1.8	mA
Driving Power ^f (Approx.)	0.4	0.6	watt
Useful Power Output ^g (Approx.)	1.4	2	watts

^a Key-down conditions per tube without amplitude modulation. Amplitude modulation essentially negative may be used if the positive peak of the audio-frequency envelope does not exceed 115 per cent of the carrier conditions.

^b Intermittent Commercial and Amateur Service.

^c Pins 4 and 5 at rf ground.

^d Obtained preferably from a separate source or from the plate-voltage supply with a voltage divider. If a series resistor is used, it should be adjustable to permit obtaining the desired operating plate current after initial tuning adjustments are completed.

^e Obtained from a grid-No.1 resistor, or from a combination of grid-No.1 resistor and either fixed supply or cathode resistor. The combination of grid-No.1 resistor and fixed supply has the advantage of not only protecting the tube from damage through loss of excitation but also of minimizing distortion by bias-supply compensation.

^f Driving power includes circuit losses and is the actual power measured at the input to the grid circuit.

^g Measured at load.

^h Obtained preferably from a separate source modulated along with the plate supply, or from the modulated plate supply through a series resistor. It is recommended that this resistor be adjustable to permit obtaining the desired operating plate current after initial tuning adjustments are made.

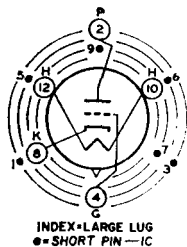
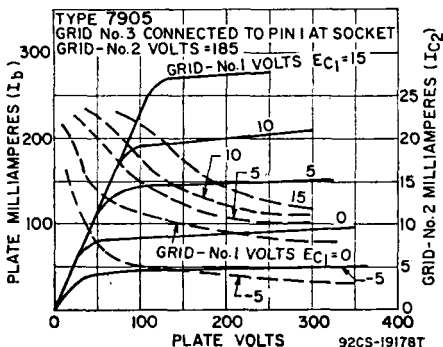

12AQ

MEDIUM-MU TRIODE

8056
 INDUSTRIAL
 TYPE

Nuvistor type, medium-mu triode for use in low voltage industrial applications. Outlines section, 1; requires nuvistor socket.

Heater Voltage (ac/dc)	6.3 ± 0.6	volts
Heater Current	0.135	ampere
Peak Heater-Cathode Voltage	±100	volts

Direct Interelectrode Capacitances (Approx.):

Grid to Plate	2.1	pF
Grid to Cathode, Shell, and Heater	4.0	pF
Plate to Cathode, Shell, and Heater	1.7	pF
Plate to Cathode	0.34	pF
Heater to Cathode	1.4	pF

Industrial Service

MAXIMUM RATINGS (Absolute-Maximum Values)

For operation at any altitude

Plate Voltage	50	volts
Grid Voltage:		
Negative-bias value	55	volts
Peak-positive value	2	volts
Grid Current	2	mA
Cathode Current	15	mA
Plate Dissipation	0.45	watt

TYPICAL OPERATION

Plate Supply Voltage	12	24	volts
Grid Supply Voltage	—	0.7	volt
Grid Resistor	33000	—	ohms
Amplification Factor	12	12	
Plate Resistance (Approx.)	1500	1500	ohms
Transconductance	8000	8000	μ mhos
Plate Current	5.5	9.5	mA

MAXIMUM CIRCUIT VALUES

Grid-Circuit Resistance:*		
For fixed-bias operation	10	megohms
For cathode-bias operation	10	megohms

* For operation at metal-shell temperatures up to 150°C. For operation at other metal-shell temperatures, see Grid-Circuit Resistance Rating Chart.

Class A₁ Amplifier

CHARACTERISTICS

Plate Supply Voltage	24	volts
Grid	Connected to negative end of cathode resistor	
Cathode Resistor	100	ohms
Amplification Factor	11.5	
Plate Resistance (Approx.)	1530	ohms
Transconductance	7500	μ mhos
Plate Current	8.7	mA
Grid Voltage (Approx.) for plate μ A = 50	—5	volts

Special Ratings & Performance Data

SHOCK RATING

Impact Acceleration	1000 max.	g
---------------------	-----------	---

FATIGUE RATING

Vibrational Acceleration	2.5 max.	g
--------------------------	----------	---

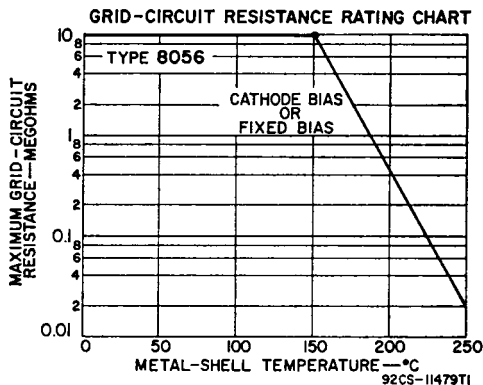
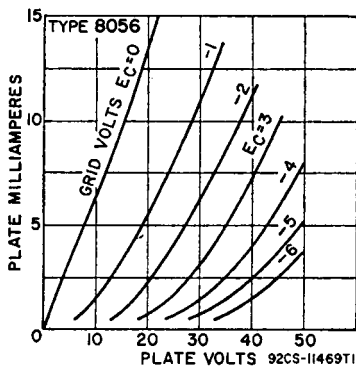

Refer to chart at end of section.

8058

8077/7054
INDUSTRIAL
TYPE

POWER PENTODE

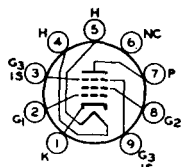

9GK

Miniature type for use as a class C radio-frequency amplifier, oscillator and frequency multiplier up to 40 MHz in mobile communications equipment. Outlines section, 6B; requires miniature 9-contact socket.

Heater Voltage	13.5 ±1.5	volts
Heater Current	0.275	ampere
Peak Heater-Cathode Voltage	±120 max.	volts
Direct Interelectrode Capacitances (Approx.):		
Grid No.1 to Plate	0.063	pF
Grid No.1 to all other Electrodes except Plate	10.2	pF
Plate to all other Electrodes except Grid No.1	3.5	pF

Class A₁—AF Power Amplifier

MAXIMUM RATINGS (Absolute-Maximum Values)

Plate Voltage	330	volts
Grid-No.3 (Suppressor Grid)	Connected to cathode at socket	
Grid-No.2 (Screen-Grid) Voltage	180	volts
Grid-No.1 (Control-Grid) Voltage:		
Negative-bias value	55	volts
Positive-bias value	0	volt
Grid-No.2 Input	1	watt
Plate Dissipation	5	watts

MAXIMUM CIRCUIT VALUES

Grid-No.1-Circuit Resistance:		
For fixed-bias operation	0.1	megohm
For cathode-bias operation	0.25	megohm

CHARACTERISTICS

Heater Voltage	13.5	volts
Plate Supply Voltage	250	volts
Grid No.3	Connected to cathode at socket	
Grid No.2 Supply Voltage	150	volts
Cathode Resistor	120	ohms
Plate Resistance (Approx.)	0.1	megohm
Transconductance	11500	μmhos
Plate Current	19	mA
Grid-No.2 Current	3.5	mA
Grid-No.1 Voltage (Approx.) for plate μA = 20	-10	volts

RF Power Amplifier & Oscillator—Class C Telegraphy^a
and
RF Power Amplifier—Class C FM Telephony

MAXIMUM CCS^b RATINGS (Absolute-Maximum Values)

DC Plate Voltage	300	volts
DC Grid No.3 (Suppressor-Grid)	Connected to cathode at socket	
DC Grid-No.2 (Screen-Grid) Voltage	175	volts
DC Grid-No.1 (Control-Grid) Voltage:		
Negative-bias value	50	volts
DC Plate Current	33	mA
DC Grid-No.2 Current	5.5	mA
DC Grid-No.1 Current	3	mA
Grid-No.2 Input	1	watt
Plate Dissipation	5	watts

TYPICAL OPERATION

At frequencies up to 40 MHz

DC Plate Voltage	200	250	300	volts
Grid No.3	Connected to cathode at socket			
DC Grid-No.2 Voltage	115	145	175	volts
DC Grid-No.1 Voltage	-7	-9	-12	volts

Peak RF Grid-No.1 Voltage	9	11	16	volts
DC Plate Current	14.5	20	26	mA
DC Grid-No.2 Current	3	4.1	5.5	mA
DC Grid-No.1 Current (Approx.)	0.6	0.85	1	mA

MAXIMUM CIRCUIT VALUE

Grid-No.1-Circuit Resistance	0.1	megohm
------------------------------------	-----	--------

Frequency Multiplier**MAXIMUM CCS^a RATINGS (Absolute-Maximum Values)**

Same as for RF POWER AMPLIFIER & OSCILLATOR

TYPICAL OPERATION

As doubler up to 40 MHz

DC Plate Voltage	200	250	300	volts
Grid No.3	Connected to cathode at socket			
DC Grid-No.2 Voltage	115	145	175	volts
DC Grid-No.1 Voltage	-16	-20	-25	volts
Peak RF Grid-No.1 Voltage	19	24	31	volts
DC Plate Current	11	15	20	mA
DC Grid-No.2 Current	2	3	4	mA
DC Grid-No.1 Current (Approx.)	0.3	0.45	0.6	mA
Driving Power (Approx.)	5	9	13	mW
Useful Power Output (Approx.)	1.4	1.9	2.5	watts

MAXIMUM CIRCUIT VALUE

Grid-No.1-Circuit Resistance	0.1	megohm
------------------------------------	-----	--------

^a Key-down conditions per tube without amplitude modulation. Amplitude modulation essentially negative may be used if the positive peak of the audio-frequency envelope does not exceed 115 per cent of the carrier conditions.

^b Continuous Commercial Service.

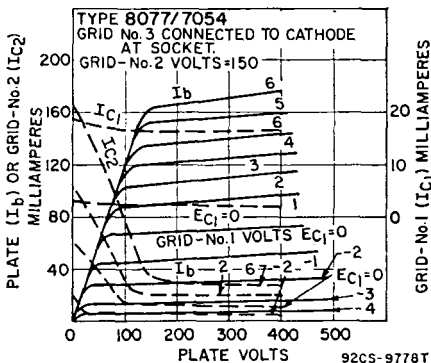
**8106**INDUSTRIAL
TYPE**BEAM POWER TUBE**

Miniature type for use as a frequency multiplier and driver in mobile communications equipment. Outlines section, 6B; requires miniature 9-contact socket.

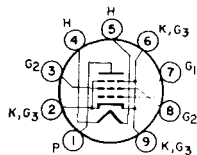
**9PL**

Heater Voltage	13.5 ± 1.5	volts
Heater Current	0.25	ampere
Peak Heater-Cathode Voltage	±100 max.	volts

Direct Interelectrode Capacitances:

Grid No.1 to Plate	0.09	pF
Grid No.1 to Cathode, Heater, Grid No.2, and Grid No.3	10	pF
Plate to Cathode, Heater, Grid No.2, and Grid No.3	2.8	pF

Class A₁ Amplifier

MAXIMUM RATINGS (Absolute-Maximum Values)

Plate Voltage	330	volts
Grid-No.2 (Screen-Grid) Voltage	300	volts
Grid-No.1 Voltage	-125	volts
Plate Dissipation	6.0	watts
Grid-No.1 Current	3.0	mA
Cathode Current	40	mA

TYPICAL OPERATION AND CHARACTERISTICS

Plate Voltage	300	volts
Grid-No.2 Voltage	150	volts
Grid-No.1 (Control-Grid) Voltage	-3.5	volts
Plate Resistance (Approx.)	90000	ohms
Transconductance	9000	μmhos
Plate Current	16	mA
Grid-No.2 Current	3.2	mA
Grid-No.1 Voltage (Approx.) for plate μA = 100	-8	volts

Refer to chart at end of section. **8136**

Refer to chart at end of section. **8203**

Refer to chart at end of section. **8233**

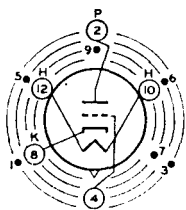

INDEX=LARGE LUG
●=SHORT PIN—IC

12AQ

MEDIUM-MU TRIODE

8393

INDUSTRIAL TYPE

Nuvistor type, medium-mu general purpose triode for use as an amplifier or oscillator at frequencies extending into the UHF region. Outlines section, 1; requires nuvistor socket. The 8393 is the same as the 7586 except for the following items:

Heater Voltage (ac/dc)	13.5 ±1.4	volts
Heater Current	0.060	ampere
Peak Heater-Cathode Voltage	±100 max.	volts
Direct Interelectrode Capacitance (Approx.):		
Grid to Plate	2.4	pF
Grid to Cathode, Heater, and Shell	4.4	pF
Plate to Cathode, Heater, and Shell	1.6	pF
Plate to Cathode	0.26	pF
Heater to Cathode	1.7	pF

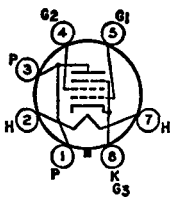

8LY

BEAM POWER TUBE

8417

Glass octal type used as output amplifier in high-fidelity, high-power sound systems. Outlines section, 19J; requires octal socket. This tube, like other power-handling tubes, should be adequately ventilated. Heater: volts (ac/dc), 6.3; amperes, 1.6; maximum heater-cathode volts, ±200 peak, 100 average.

Class A₁ Amplifier

MAXIMUM RATINGS (Design-Maximum Values)

Plate Voltage	660	volts
Grid-No.2 (Screen-Grid) Voltage	500	volts
Cathode Current	200	mA
Plate Dissipation*	35	watts
Grid-No.2 Input	5*	watts

CHARACTERISTICS

Plate Voltage	300	volts
Grid-No.2 Voltage	300	volts
Grid-No.1 (Control-Grid) Voltage	-12	volts
Grid-No.1 Voltage for plate current of 1 mA	-37	volts
Plate Resistance	16000	ohms
Transconductance	23000	μmhos
Plate Current	100	mA
Grid-No.2 Current	5.5	mA
Triode Amplification Factor	16.5	

MAXIMUM CIRCUIT VALUES

Grid-No.1-Circuit Resistance:		
For fixed-bias operation	1	megohm
For cathode-bias operation	0.25	megohm

Push-Pull Class AB₁ AmplifierMAXIMUM RATINGS (Same as for Class A₁ Amplifier)

TYPICAL OPERATION (Values are for two tubes)

Plate Supply Voltage	400	560	volts
Grid-No.2 Supply Voltage	275	300	volts
Grid-No.1 Voltage	-13	-15.5	volts
Peak AF Grid-to-Grid Voltage	24	31	volts
Zero-Signal Plate Current	150	100	mA
Maximum-Signal Plate Current	294	270	mA
Zero-Signal Grid-No.2 Current	4.4	3.4	mA
Maximum-Signal Grid-No.2 Current	34	31	mA
Effective Load (Plate-to-Plate)	2800	4200	ohms
Total Harmonic Distortion	2.5	2	per cent
Maximum Signal Power Output	65	100	watts

* A bias resistor or other means is required to protect the tube in absence of excitation.

* Grid-No.2 may reach 8 watts during peak levels of speech and music levels.

8532 Refer to chart at end of section.

8532/6J4WA Refer to chart at end of section.

8532W Refer to chart at end of section.

8627 Refer to chart at end of section.

8627A Refer to chart at end of section.

8628 Refer to chart at end of section.

8808 Refer to chart at end of section.

8950 Refer to chart at end of section.

9001 Refer to chart at end of section.

9002 Refer to chart at end of section.

9003 Refer to chart at end of section.

9005 Refer to chart at end of section.

9006 Refer to chart at end of section.

Refer to type 1S2A/DY87.	DY87
Refer to type 6AK8/EABC8.	EABC80
Refer to type 6DC8/EBF89.	EBF89
Refer to type 6DL4/EC88.	EC88
Refer to type 6FY5/EC97.	EC97
Refer to type 12AT7/ECC81.	ECC81
Refer to type 12AU7A/ECC82.	ECC82
Refer to type 12AX7A/ECC83.	ECC83
Refer to type 6AQ8/ECC85.	ECC85
Refer to type 6ES8/ECC189.	ECC189
Refer to type 6BL8/ECF80.	ECF80
Refer to type 6HG8/ECF86.	ECF86
Refer to type 6X9/ECF200.	ECF200
Refer to type 6U9/ECF201.	ECF201
Refer to type 6GJ7/ECF801.	ECF801
Refer to type 6JW8/ECF802.	ECF802
Refer to type 6BM8/ECL82.	ECL82
Refer to type 6DX8/ECL84.	ECL84
Refer to type 6GV8/ECL85.	ECL85
Refer to type 6GW8/ECL86.	ECL86
Refer to type 6AM6/EF91.	EF91
Refer to type 6BA6/EF93.	EF93
Refer to type 6AK5/EF95.	EF95
Refer to type 6EH7/EF183.	EF183
Refer to type 6EJ7/EF184.	EF184
Refer to type 6X9/EFL200.	EFL200
Refer to type 6CA7/EL34.	EL34
Refer to type 6BQ5/EL84.	EL84
Refer to type 6CW5/EL86.	EL86
Refer to type 6DL5/EL95.	EL95
Refer to type 6GB5/EL500.	EL500

EL509	Refer to type 6KG6A/EL509.
ELL80	Refer to type 6HU8/ELL80.
EM84 EM84/6GFG6	Refer to chart at end of section.
EM87	Refer to type 6HU6/EM87.
EY88	Refer to type 6AL3/EY88.
EY500	Refer to type 6EC4A/EY500.
GZ34	Refer to type 5AR4/GZ34.
HCC85	Refer to type 17EW8/HCC85.
LCF80	Refer to type 6LN8/LCF80.
LCF86	Refer to type 5HG8/LCF86.
LCF201	Refer to type 5U9/LCF201.
LCF801	Refer to type 5GJ7/LCF801.
LCF802	Refer to type 6LX8/LCF802.
LCL84	Refer to type 10DX8/LCL84.
LCL85	Refer to type 10GV8/LCL85.
LF183	Refer to type 4EH7/LF183.
LF184	Refer to type 4EJ7/LF184.
LFL200	Refer to type 11Y9/LFL200.
LL86	Refer to type 10CW5/LL86.
LL500	Refer to type 18GB5/LL500.
LY88	Refer to type 20AQ3/LY88.
PC900	Refer to type 4HA5/PC900.
PCC85	Refer to type 9AQ8/PCC85.
PCC88	Refer to type 7DJ8/PCC88.
PCF80	Refer to type 9A8/PCF80.
PCF86	Refer to type 7HG8/PCF86.
PCF801	Refer to type 8GJ7/PCF801.
PCF802	Refer to type 9JW8/PCF802.
PCL82	Refer to type 16A8/PCL82.
PCL84	Refer to type 15DQ8/PCL84.

Refer to type 6GV8/PCL85.	PCL85
Refer to type 25E5/PL36.	PL36
Refer to type 15CW5/PL84.	PL84
Refer to type 27GB5/PL500.	PL500
Refer to type 40KG6A/PL509.	PL509
Refer to type 29KQ6/PL521.	PL521
Refer to type 17Z3/PY81.	PY81
Refer to type 30AE3/PY88.	PY88
Refer to type 42EC4A/PY500.	PY500
Refer to type 50BM8/UCL82.	UCL82
Refer to type 4ES8/XCC189.	XCC189
Refer to type 4BL8/XCF80.	XCF80
Refer to type 4GJ7/XCF801.	XCF801
Refer to type 9GV8/XCL85.	XCL85
Refer to type 3EH7/XF183.	XF183
Refer to type 3EJ7/XF184.	XF184
Refer to type 8CW5/XL86.	XL86
Refer to type 13GB5/XL500.	XL500
Refer to type 16AQ3/XY88.	XY88
Refer to type 5ES8/YCC189.	YCC189

Characteristics Entertainment and Industrial

Key to Chart: Type numbers shown in light face are discontinued types. Type numbers shown in bold face are available for replacement use, but are not recommended for new equipment design. Outline numbers refer to diagrams shown in

RCA Type	Name	Out- line	Terminal Dia- gram	Heater or Filament (F)		Use Values to right give operat- ing conditions and charac- teristics for indicated typical use
				Volts	Amperes	
0A2WA ♦	Glow-Discharge Tube	5D	5B0	—	—	Voltage Regulator
0A3 ♦	Glow-Discharge Tube	22	4AJ	—	—	Voltage Regulator
0A3A ♦		13C				
0A4A ♦	Gas-Triode	22	4V	—	—	Relay Circuits
0B2WA ♦	Glow-Discharge Tube	5D	5B0	—	—	Voltage Regulator
0C2 ♦	Glow-Discharge Tube	5D	5B0	—	—	Voltage Regulator
0C3A ♦	Glow-Discharge Tube	13C	4AJ	—	—	Voltage Regulator
0D3A ♦	Glow-Discharge Tube	13C	4AJ	—	—	Voltage Regulator
0Z4	Full-Wave Gas Rectifier	2A	4R	—	—	Rectifier
0Z4G	Full-Wave Gas Rectifier	29D	4R	—	—	Rectifier
1A3	Diode	5C	5AP	1.4	0.15	Rectifier
1A4P	Remote-Cutoff Pentode	24B	4M	2.0F	0.06	Class A Amplifier
1A5GT	Power Pentode	13D	6X	1.4F	0.05	Class A Amplifier
1A6	Pentagrid Converter	24B	6L	2.0F	0.06	Converter
1A7GT	Pentagrid Converter	14A	7Z	1.4F	0.05	Converter
1A65	Power Converter	29A	8CP	1.25F	0.04	Class A Amplifier
★1A02	Half-Wave Rectifier	9A	12GV	1.25F	0.2	Pulsed Rectifier in TV Receivers
1A05	Sharp-Cutoff Pentode	29A	8CP	1.25F	0.04	Class A Amplifier
1A02	Half-Wave Rectifier	7A	9Y	1.4F	0.65	Pulsed Rectifier in TV Receivers
★1A02	Half-Wave Rectifier	33A	1A02	1.25F	0.2	Pulsed Rectifier in TV Receivers
★1B3GT	Half-Wave Rectifier	14E	3C	1.25F	0.2	Pulsed Rectifier in TV Receivers
1B4P	Sharp-Cutoff Pentode	24B	4M	2.0F	0.06	Class A Amplifier
1B5/ 25S	Twin Diode—Medium-Mu Triode	22 or 13H	6M	2.0F	0.06	Triode Unit as Class A Amplifier
1B7GT	Pentagrid Converter	14A	7Z	1.4F	0.10	Converter

♦ Industrial type

★ See Safety Precautions at end of this section.

Chart for RCA Receiving Tubes

the Outlines section in the Manual (see Table of Contents on page two. Terminal diagrams are included in numerical-alphabetical order in Terminal Diagram section. (See Table of Contents).

Plate Volts	Grid Bias or Cathode Resistor	Screen Grid Volts	Screen Grid Cur- rent mA	Plate Cur- rent mA	AC Plate Resist- ance Ohms	Trans- conduct- ance Micromhos	Amplifi- cation Factor	Power		RCA Type
								Load Ohms	Out- put Watts	
For other characteristics, refer to Type OA2										OA2WA*
75	—	—	—	5-40	—	—	—	—	—	OA3* OA3A*
130	—	—	—	25	—	—	—	—	—	OA4A*
For other characteristics, refer to Type OB2										OB2WA*
75	—	—	—	5-30	—	—	—	—	—	OC2*
For other characteristics, refer to Type OC3										OC3A*
For other characteristics, refer to Type OD3										OD3A*
Starting-Supply Voltage per Plate, 300 min. peak volts DC Output Current, 75 max., 30 min. mA							Peak Plate Current, 200 max. mA DC Output Voltage, 300 max. volts			OZ4
Starting-Supply Voltage per Plate, 300 min. peak volts DC Output Current, 75 max., 30 min. mA							Peak Plate Current, 200 max. mA DC Output Voltage, 300 max. volts			OZ4G
Max. Peak Plate Inverse Volts, 330 Max. Peak Plate mA, 5							Max. DC Output mA, 0.5 Max. Peak Heater-Cathode Volts, 140			1A3
For other characteristics, refer to Type 1D5GP										1A4P
85	— 4.5V	85	0.7	3.5	300000	800	—	25000	0.100	1A5GT
90	— 4.5V	90	1.1	4.0	300000	850	—	25000	0.115	
135	— 3V	67.5	2.5	1.2	400000	Anode-Grid (2): 180 max. volts 2.3 mA Oscillator-Grid (1) Resistor.				1A6
180	— 3V	67.5	2.4	1.3	500000	Anode-Grid (2): 90 volts, 1.2 mA Oscillator-Grid (1) Resistor, 0.2 MΩ Conversion Transcond., 250 micromhos				
90	0V	45	0.7	0.6	600000	Anode-Grid (2): 90 volts, 1.2 mA Oscillator-Grid (1) Resistor, 0.2 MΩ Conversion Transcond., 250 micromhos				1A7GT
45	— 3V	45	0.2	1.0	170000	600	—	40000	0.015	1AC5
67.5	— 4.5V	67.5	0.4	2.0	150000	750	—	25000	0.050	
Max. Peak Inverse Plate Volts, 26000 Max. Peak Plate mA, 50							Max. Average Plate mA, 0.5			1AD2
30	0V	30	0.16	0.45	700000	430	—	—	—	1AD5
67.5	0V	67.5	0.75	1.85	700000	735	—	—	—	
Max. Peak Inverse Plate Volts, 25000 Max. Peak Plate mA, 45							Max. Average Plate mA, 0.5			1AX2
Max. Peak Inverse Plate Volts, 26000 Max. Peak Plate mA, 50							Max. Average Plate mA, 0.5			1AY2
Max. Peak Inverse Plate Volts, 26000 Max. Peak Plate mA, 50							Max. Average Plate mA, 0.5			1B3GT
For other characteristics, refer to Type 1E5GP										1B4P
For other characteristics, refer to Type 1H6G										1B5/ 25S
For other characteristics, refer to Type 1A7GT										1B7GT

RCA Type	Name	Out-line	Terminal Diagram	Heater or Filament (F)		Use Values to right give operating conditions and characteristics for indicated typical use
				Volts	Amperes	
★1BC2	Half-Wave Rectifier	7E	9RG	1.25	0.2	Pulsed Rectifier in TV Receivers
★1BH2 ★1BH2A	Half-Wave Rectifier	7G	9RG	1.25	0.2	Flyback Rectifier in TV Receivers
1C5GT	Power Pentode	13D	6X	1.4F	0.10	Class A Amplifier
1C6	Pentagrid Converter	24B	6L	2.0F	0.12	Converter
1C7G	Pentagrid Converter	23	7Z	2.0F	0.12	Converter
1C21 †	Gas-Triode	13J	4V	—	—	Relay Circuits
1D5GP	Remote-Cutoff Pentode	23	5Y	2.0F	0.06	Class A Amplifier
1D5GT	Remote-Cutoff Tetrode	23	5R	2.0F	0.06	Class A Amplifier
1D7G	Pentagrid Converter	23	7Z	2.0F	0.06	Converter
1D8GT	Diode-Triode-Power Pentode	14A	8AJ	1.4F	0.10	Pentode Unit as Class A Amplifier Triode Unit as Class A Amplifier
★1DG3	Half-Wave Rectifier	14J	8ND	1.25F	0.2	Pulsed Rectifier in TV Receivers
1DN5	Diode—Semiremote-Cutoff Pentode	5C	6BW	1.4F	0.5	Pentode Unit as Class A Amplifier
1E5GP	Sharp-Cutoff Pentode	23	5Y	2.0F	0.06	Class A Amplifier
1E7GT	Twin Power Pentode	13D	8C	2.0F	0.24	Class A Amplifier
1E8	Pentagrid Converter	29A	8CN	1.25F	0.04	Converter
1F4	Power Pentode	26	5K	2.0F	0.12	Class A Amplifier
1F5G	Power Amplifier Pentode	25	6X	2.0F	0.12	Class A Amplifier
1F6	Twin Diode—Sharp-Cutoff Pentode	23	6W	2.0F	0.06	Pentode Unit as Class A Amplifier
1F7G	Twin Diode—Sharp-Cutoff Pentode	23	7AF	2.0F	0.06	Pentode Unit as Class A Amplifier
★1G3GT/ 1B3GT	Half-Wave Rectifier	14B	3C	1.25F	0.2	Pulsed Rectifier in TV Receivers
1G4GT	Medium-Mu Triode	13D	5S	1.4F	0.05	Class A Amplifier
1G5G	Power Pentode	25	6X	2.0F	0.12	Class A Amplifier
1G6GT	High-Mu Twin Power Triode	13D	7AB	1.4F	0.10	Class B Amplifier
1H4G	Medium-Mu Triode	22	5S	2.0F	0.06	Class A Amplifier Class B Amplifier
1H5GT	Diode—High-Mu Triode	14A	5Z	1.4F	0.05	Triode Unit as Class A Amplifier
1H6G	Twin Diode—Medium-Mu Triode	22	7AA	2.0F	0.06	Triode Unit as Class A Amplifier
★1J3	Half-Wave Rectifier	14E	3C	1.25F	0.2	Pulsed Rectifier in TV Receivers
1J5G	Power Pentode	25	6X	2.0F	0.12	Class A Amplifier
1J6G 1J6GT	Twin-Triode Amplifiers	22 13F	7AB	2.0F	0.24	Class B Amplifier
★1K3	Half-Wave Rectifier	14B	3C	1.25F	0.2	Pulsed Rectifier in TV Receivers
★1K3/ 1J3	Half-Wave Rectifier	14B	3C	1.25F	0.2	Pulsed Rectifier in TV Receivers
1L4	Pentode	5C	6AP	1.4F	0.05	RF Amplifier

† Industrial type

★ See Safety Precautions at end of this section.

Plate Volts	Grid Bias or Cathode Resistor	Screen Grid Volts	Screen Grid Cur- rent mA	Plate Cur- rent mA	AC Plate Resist- ance Ohms	Trans- conduct- ance Micromhos	Amplifi- cation Factor	Power		RCA Type
								Load Ohms	Out- put Watts	
Max. Peak Inverse Plate Volts, 18000 Max. Peak Plate mA, 45				18000			Max. Average Plate mA, 0.5		1B2C	
Max. Peak Inverse Plate Volts, 18000 Max. Peak Plate mA, 45				18000			Max. Average Plate mA, 0.2		1B2H 1B2A	
90	- 7.5V	90	3.5	7.8	115000	1550	—	8000	0.24	1C5GT
For other characteristics, refer to Type 1C7G										
135	- 3V	67.5	2.5	1.3	600000	Anode-Grid (2): 180 max. volts, 4.0 mA Oscillator-Grid (1) Resistor, Conversion Transcond., 325 micromhos.				1C7G
180	- 3V	67.5	2.0	1.5	700000					
145	0	—	—	25	—	—	—	—	—	1C21*
90	{ - 3V min. }	67.5	0.9	2.2	600000	720	—	—	—	1D5GP
180		67.5	0.8	2.3	1 M	750	—	—	—	
For other characteristics, refer to Type 1D5GP										
For other characteristics, refer to Type 1A6										
90	- 9V	90	1.0	5.0	—	925	—	12000	0.200	1D8GT
90	0V	—	—	1.1	43500	575	25	—	—	
Max. Peak Inverse Plate Volts, 26000 Max. Peak Plate mA, 50							Max. Average Plate mA, 0.5		1D63	
67.5	0V	67.5	0.55	2.1	600000	630	—	—	—	1D95
90	- 3V	67.5	0.7	1.6	1 M	600	—	—	—	1E5GP
180	- 3V	67.5	0.6	1.7	1.5 M	650	—	—	—	
135	- 7.5V	135	3.5	10.5	—	—	—	24000	0.575	1E7GT
45	0V	45	1.1	0.6	400000	Oscillator Grid (1) Resistor, 0.1 MΩ Conversion Transcond., 150 micromhos				1E8
67.5	0V	67.5	1.5	1.0	400000					
For other characteristics, refer to Type 1F5G										
90	- 3V	90	1.1	4.0	240000	1400	—	20000	0.11	1F5G
135	- 4.5V	135	2.4	8.0	—	—	—	—	0.31	
For other characteristics, refer to Type 1F7G										
180	- 1.5V	67.5	0.7	2.2	—	—	—	—	—	1F7G
Max. Peak Inverse Plate Volts, 26000 Max. Peak Plate mA, 50							Max. Average Plate mA, 0.5		1G3GT/ 1B3GT	
90	- 6V	—	—	2.3	10700	825	8.8	—	—	1G4GT
90	- 6V	90	2.5	8.5	133000	1500	—	8500	0.25	1G5G
135	-13.5V	135	2.5	9.7	160000	1550	—	9000	0.55	
90	0V	—	11	—	—	—	—	12000	0.350	1G6GT
180	-13.5V	—	—	3.1	10300	900	9.3	—	—	1H4G
157.5	-15V	—	—	1.0□	—	—	—	8000	2.1†	
90	0V	—	—	0.15	240000	275	65	—	—	1H5GT
135	- 3V	—	—	0.8	35000	575	20	—	—	1H6G
Max. Peak Inverse Plate Volts, 26000 (Abs.) Max. Peak Plate mA, 50							Max. Average Plate mA, 0.5		1J3	
135	-16.5V	135	2.0	7.0	105000	950	—	13500	0.45	1J5G
135	0V	—	—	Power Output is for one tube at stated plate-to-plate load				10000	2.1	1J6G
135	- 3V	—	—					10000	1.9	1J6GT
Max. Peak Inverse Plate Volts, 26000 (Abs.) Max. Peak Plate mA, 50							Max. Average Plate mA, 0.5		1K3	
Max. Peak Inverse Plate Volts, 26000 Max. Peak Plate mA, 50							Max. Average Plate mA, 0.5		1K3/ 1J3	
90	0	90	2	4.5	350000	1025	—	—	—	1L4

† For two tubes at stated plate-to-plate load.

□ For two tubes.

RCA Type	Name	Out- line	Terminal Dia- gram	Heater or Filament (F)		Use Values to right give operat- ing conditions and character- istics for indicated typical use
				Volts	Amperes	
1L6	Pentagrid Converter	5C	70C	1.4F	0.05	Converter
1LA4	Power Pentode	12B	5AD	1.4F	0.05	Amplifier
1LA6	Pentagrid Converter	12B	7AK	1.4F	0.05	Converter
1LB4	Power Pentode	12B	5AD	1.4F	0.05	Class A Amplifier
1LC5	Sharp-Cutoff Pentode	12B	7AO	1.4F	0.05	Class A Amplifier
1LC6	Pentagrid Converter	12B	7AK	1.4F	0.05	Converter
1LD5	Diode—Sharp-Cutoff Pentode	12B	6AX	1.4F	0.05	Pentode Unit as Class A Amplifier
1LE3	Medium-Mu Triode	12B	4AA	1.4F	0.05	Class A Amplifier
1LG5	Remote-Cutoff Pentode	12B	7AO	1.4F	0.05	Class A Amplifier
1LH4	Diode—High-Mu Triode	12B	5AG	1.4F	0.05	Triode Unit as Class A Amplifier
1LN5	Sharp-Cutoff Pentode	12B	7AO	1.4F	0.05	Class A Amplifier
★1N2A	Half-Wave Rectifier	19A	3C	1.25F	0.2	Pulsed Rectifier in TV Receivers
1N5GT	Sharp-Cutoff Pentode	14A	5Y	1.4F	0.05	Class A Amplifier
1N6G	Diode—Power Pentode	29A	7AM	1.4F	0.05	Pentode Unit as Class A Amplifier
1P5GT	Remote-Cutoff Pentode	14A	5Y	1.4F	0.05	Class A Amplifier
1Q5GT	Beam Power Tube	13D	6AF	1.4F	0.1	Class A Amplifier
1R5	Pentagrid Converter	5C	7AT	1.4F	0.05	Converter
★1S2A/ DY87	Half-Wave Rectifier	7F	9DT	1.4	0.55	Pulsed Rectifier in TV Receivers
1S4	Power Pentode	5C	7AV	1.4F	0.1	Class A Amplifier
1S5	Diode—Sharp-Cutoff Pentode	5C	6AU	1.4F	0.05	Pentode Unit as AF Amplifier
1T4	Remote-Cutoff Pentode	5C	6AR	1.4F	0.05	Class A Amplifier
1T5GT	Beam Power Tube	13D	6X	1.4F	0.05	Class A Amplifier
1T6	Diode—Sharp-Cutoff Pentode	29A	8DA	1.25F	0.04	Pentode Unit as Class A Amplifier
1U4	Sharp-Cutoff Pentode	5C	6AR	1.4F	0.05	Class A Amplifier
1U5	Diode—Sharp-Cutoff Pentode	5C	6BW	1.4F	0.05	Pentode Unit as Class A Amplifier
1V	Half-Wave Rectifier	22 or 13H	4G	6.3	0.3	With Capacitive-Input Filter
★1X2A	Half-Wave Rectifier	7A	9Y	1.25F	0.2	Pulsed Rectifier in TV Receivers
1X2B ★1X2B/ 1X2A	Half-Wave Rectifier	7A	9Y	1.25F	0.2	Pulsed Rectifier in TV Receivers
2A3	Power Triode	27B	4D	2.5F	2.5	Class A Amplifier Push-Pull Class AB ₁ Amplifier
2A5	Power Pentode	28	6B	2.5	1.75	Amplifier
2A6	Twin Diode—High-Mu Triode	24B	6G	2.5	0.8	Triode Unit as Amplifier
2A7	Pentagrid Converter	24B	7C	2.5	0.8	Converter

★ See Safety Precautions at end of this section.

Plate Volts	Grid Bias or Cathode Resistor	Screen Grid Volts	Screen Grid Cur- rent mA	Plate Cur- rent mA	AC Plate Resist- ance Ohms	Trans- conduct- ance Micromhos	Amplifi- cation Factor	Power		RCA Type
								Load Ohms	Out- put Watts	
90	0V	45	0.6	0.5	650000	Anode-Grid (2): 90 max. volts, 1.2 mA Oscillator Grid (1) Resistor, 0.2 MΩ Conversion Transcond., 300 micromhos			1L6	
For other characteristics, refer to Type 1A5GT										1LA4
90	0V	65	0.6	0.55	750000	Total Cathode mA, 4 Conversion Transcond. (for grid-No. 4 bias of -3 volts), 10 micromhos			1LA6	
For other characteristics, refer to Pentode Unit of Type 1D8GT										1LB4
45	0V	45	0.35	1.10	700000	750	—	—	—	1LC5
90	0V	45	0.30	1.15	1 M	775	—	—	—	
45	0V	35	0.75	0.70	300000	Anode-Grid (2): 50 max. volts, 1.4 mA Oscillator-Grid (1) Resistor, 0.2 MΩ Conversion Transcond., 275 micromhos			1LC6	
90	0V	35	0.70	0.75	650000					
90	0V	45	0.1	0.6	750000	575	—	—	—	1LD5
90	0V	—	—	4.5	11200	1300	14.5	—	—	1LE3
90	-3V	—	—	1.4	19000	760	14.5	—	—	
90	0V	45	0.4	1.7	1 M	800	—	—	—	1LG5
90	-1.5V	90	0.9	3.7	500000	1150	—	—	—	
For other characteristics, refer to Type 1H5GT										1LH4
90	0V	90	0.35	1.6	1.1 M	800	—	—	—	1LN5
Max. Peak Inverse Plate Volts (Total DC and Peak), 28000					Max. Average Plate mA, 0.5					1N2A
Max. Peak Plate mA, 50										
0V	90	0.3	1.2	1.5 M	750	—	—	—	90	1N5GT
90	-4.5V	90	0.6	3.1	300000	800	—	25000	0.1	1N6G
90	0V	90	0.7	2.3	800000	750	—	—	—	1P5GT
110	-6.6V	110	1.4	10	100000	2200	—	8000	0.4	1Q5GT
45	0V	45	2.1	0.7	400000	Conversion Transcond., 210 μmhos			1R5	
90	0V	67.5	3.5	1.5	500000	Conversion Transcond., 280 μmhos				
Max. Peak Inverse Plate Volts, 22000					Max. Average Plate mA, 0.8					1S2A/ DY87
Max. Peak Plate mA, 40										
45	-4.5V	45	0.8	3.8	100000	1250	—	8000	0.065	1S4
90	-7V	67.5	1.4	7.4	100000	1575	—	8000	0.27	
Plate Supply, 90 V applied through 1 MΩ resistor. Screen Supply, 90 V applied through 3.1 MΩ resistor. Grid Bias, 0 volts. Grid Resistor, 10 megohms. Voltage Gain, 66 approx.										1S5
45	0V	45	0.7	1.7	350000	700	—	—	—	1T4
90	0V	67.5	1.4	3.5	500000	900	—	—	—	
90	-6V	90	0.8	6.5	250000	1150	—	14000	0.17	1T5GT
45	0V	45	0.21	0.75	500000	475	—	—	—	1T6
67.5	0V	67.5	0.4	1.6	400000	600	—	—	—	
90	0V	90	0.50	1.1	1 M	900	—	—	—	1U4
67.5	0V	67.5	0.4	1.6	600000	625	—	—	—	1U5
Max. AC Plate Volts (RMS), 325					Min. Total Effective Plate-Supply Impedance: Up to 117					1V
Max. DC Output mA, 45					volts, 0 ohms; at 150 volts, 30 ohms; at 325 volts, 75 ohms					
Max. Peak Inverse Plate Volts, 20000					Max. Average Plate mA, 0.5					1X2A
Max. Peak Plate mA, 45										
Max. Peak Inverse Plate Volts, 22000					Max. Average Plate mA, 0.5					1X2B
Max. Peak Plate mA, 45										1X2B/ 1X2A
250	-45V	—	—	60.0	800	5250	4.2	2500	3.5	2A3
300	780Ω□	—	—	80.0□	—	—	—	5000	10.0†	
300	-62V	—	—	80.0□	—	—	—	3000	15.0†	
For other characteristics, refer to Type 6F6G										2A5
For other characteristics, refer to Type 6SQ7										2A6
For other characteristics, refer to Type 6A8										2A7

† For two tubes at stated plate-to-plate load.

□ For two tubes.

RCA Type	Name	Out- line	Terminal Dia- gram	Heater or Filament (F)		Use Values to right give operat- ing conditions and character- istics for indicated typical use
				Volts	Amperes	
2AF4A 2AF4B	Medium-Mu Triode	5B	7DK	2.35	0.6	Class A Amplifier
★2AH2	Half-Wave Rectifier	9A	12DG	2.5	0.3	Pulsed Rectifier in TV Receivers
★2AS2	Half-Wave Rectifier	9B	12EW	2.5	0.33	Pulsed Rectifier in TV Receivers
2B7	Twin Diode—Remote-Cutoff Pentode	24B	7D	2.5	0.8	Pentode Unit as Amplifier
2BA2	Half-Wave Rectifier	6B	9U	1.8F	0.3	Flyback Rectifier in TV Receivers
★2BJ2	Half-Wave Rectifier	7A	9RT	2.3	0.3	Pulsed Rectifier in TV Receivers
★2BJ2A	Half-Wave Rectifier	7A	9RT	2.3	0.3	Pulsed Rectifier in TV Receivers
2BN4	Medium-Mu Triode	5C	7EG	2.3	0.6	Class A Amplifier
2D21W [†]	Gas-Tetrode	5C	7BN	6.3	0.6	Thyratron
★2CN3A	Half-Wave Rectifier	14F	8MU	1.8	0.9	Flyback Rectifier in TV Receivers
2DZ4	Medium-Mu Triode	5B	7DK	2.35	0.6	Class A Amplifier
2E5	Electron-Ray Tube	22 or 13H	6R	2.5	0.8	Visual Indicator
2EN5	Twin Diode	5C	7FL	2.1	0.45	Horizontal Phase Detector
2ER5	High-Mu Triode	5C	7FP	2.3	0.6	Class A Amplifier
2FQ5A	High-Mu Triode	5C	7FP	2.3	0.6	Class A Amplifier
2GK5	High-Mu Triode	5C	7FP	2.3	0.6	Class A Amplifier
2GU5	Beam Hexode	5C	7GA	2.4	0.6	Class A Amplifier
★3A2	Half-Wave Rectifier	7A	9DT	3.15	0.22	Pulsed Rectifier in TV Receivers
★3A3 3A3/3B2	Half-Wave Rectifier	14E	8EZ	3.15	0.22	Pulsed Rectifier in TV Receivers
3A3A ★3A3A/ 3B2	Half-Wave Rectifier	14F	8EZ	3.15	0.22	Pulsed Rectifier in TV Receivers
★3A3B	Half-Wave Rectifier	14F	8EZ	3.15	0.22	Pulsed Rectifier in TV Receivers
3A4 [†]	Tetrode	5C	7BB	1.4F 2.8F	0.2 0.1	AF Power Amplifier
3A8GT	Diode-Triode—Pentode	29C	8AS	1.4F 2.8F	0.1 0.05	Triode Unit as Class A Amplifier Pentode Unit as Class A Amplifier
3AF4A	Medium-Mu Triode	5B	7DK	3.15	0.45	Class A Amplifier
★3AT2	Half-Wave Rectifier	9B	12FV	3.15	0.22	Pulsed Rectifier in TV Receivers
3AV6	Twin Diode—High-Mu Triode	5C	7BT	3.15	0.6	Triode Unit as Class A Amplifier
3AW2	Half-Wave Rectifier	9B	12EW	3.15	0.39	Pulsed Rectifier in TV Receivers
3AW3	Half-Wave Rectifier	14B	8EZ	3.15	0.22	Pulsed Rectifier in TV Receivers
3B2	Half-Wave Rectifier	21C	8GH	3.15	0.22	Pulsed Rectifier in TV Service
3B4WA [†]	Beam Power Tube	5C	7CY	1.25F 2.50F	0.33 0.165	Class C Amplifier
3BA6	Remote-Cutoff Pentode	5C	7BK	3.15	0.6	Class A Amplifier
3BC5	Sharp-Cutoff Pentode	5C	7BD	3.15	0.6	Class A Amplifier
3BE6	Pentagrid Converter	5C	7CN	3.15	0.6	Converter

[†] Industrial type

★ See Safety Precautions at end of this section.

Plate Volts	Grid Bias or Cathode Resistor	Screen Grid Volts	Screen Grid Current mA	Plate Current mA	AC Plate Resistance Ohms	Trans- conductance Micromhos	Amplifi- cation Factor	Power		RCA Type
								Load Ohms	Out- put Watts	
80	150Ω	—	—	17.5	2100	6500	13.5	—	—	2AF4A 2AF4B
Max. Peak Inverse Plate Volts, 30000 Max. Peak Plate mA, 80							Max. Average Plate mA, 1.5		2AH2	
Max. Peak Inverse Plate Volts, 30000 Max. Peak Plate mA, 80							Max. Average Plate mA, 1.5		2AS2	
For other characteristics, refer to Type 6B8G										2B7
Max. Peak Inverse Plate Volts, 8250 Max. Peak Plate mA, 50							Max. Average Plate mA, 0.6		2BA2	
Max. Peak Inverse Plate Volts, 20000 Max. Peak Plate mA, 80							Max. Average Plate mA, 1		2BJ2	
Max. Peak Inverse Plate Volts, 22000 Max. Peak Plate mA, 80							Max. Average Plate mA, 1		2BJ2A	
150	220Ω	—	—	9	6300	6800	43	—	—	2BN4
For other characteristics, refer to Type 2D21										2D21W*
For other characteristics, refer to Type 3CN3A										2CN3A
80	—	—	—	15	2000	6700	14	—	—	2DZ4
For other characteristics, refer to Type 6E5										2E5
Max. Peak Heater-Cathode Volts, ±200 DC Volts Not to Exceed +100							Max. DC Plate mA, 5		2EN5	
For other characteristics, refer to Type 6ER5										2ER5
For other characteristics, refer to type 6FQ5A										2FQ5A
For other characteristics, refer to Type 6GK5/6FQ5A										2GK5
For other characteristics, refer to Type 6GU5										2GU5
Max. Peak Inverse Plate Volts, 18000 Max. Peak Plate mA, 80							Max. Average Plate mA, 1.5		3A2	
Max. Peak Inverse Plate Volts, 30000 Max. Peak Plate mA, 88							Max. Average Plate mA, 1.7		3A3 3A3/3B2	
Max. Peak Inverse Plate Volts, 30000 Max. Peak Plate mA, 100							Max. Average Plate mA, 2		3A3A 3A3A/ 3B2	
Max. Peak Inverse Plate Volts, 38000 Max. Peak Plate mA, 100							Max. Average Plate mA, 2		3A3B	
150	-8.4V	90	2.2	133	100000	1900	—	8000	0.7	3A4*
90	0V	—	—	0.2	200000	325	65	—	—	3A8GT
90	0V	90	0.5	1.5	800000	750	—	—	—	3AF4A
For other characteristics, refer to Type 2AF4B										3AF4A
Max. Peak Inverse Plate Volts, 30000 Max. Peak Plate mA, 88							Max. Average Plate mA, 1.7		3AT2	
For other characteristics, refer to Type 6AV6										3AV6
For other characteristics, refer to Type 3CZ3										3AW2
For other characteristics, refer to Type 3A3/3B2										3AW3
Max. Peak Plate mA, 80 Max. Total DC & Peak Inverse Plate Volts, 35000 (Abs.)							Max. DC Inverse Plate Volts, 25000 Max. Average Plate mA, 1.1		3B2	
150	-38V	135	6.2	25	—	—	—	—	1.25	3B4WA*
100	68Ω	100	4.4	10.8	250000	4300	—	—	—	3BA6
250	68Ω	100	4.2	11	1 M	4400	—	—	—	3BA6
100	180Ω	100	1.4	4.7	600000	4900	—	—	—	3BC5
250	180Ω	150	2.1	7.5	800000	5700	—	—	—	3BC5
250	Self- Excited	100	6.8	2.9	1 M	Conversion Transcond., 475 μmhos Grid-No. 1 Resistor, 20000 ohms		—		3BE6

RCA Type	Name	Out- line	Terminal Dia- gram	Heater or Filament (F)		Use Values to right give operat- ing conditions and character- istics for indicated typical use
				Volts	Amperes	
★3BL2 ★3BL2A	Half-Wave Rectifier	9B	12HK	3.3F	0.285	Pulsed Rectifier in TV Receivers
★3BM2	Half-Wave Rectifier	9B	12HK	3F	0.3	Pulsed Rectifier in TV Receivers
★3BN2 ★3BN2A	Half-Wave Rectifier	9B	12FV	3.15	0.3	Flyback Rectifiers in TV Receivers
3BN4	Medium-Mu Triode	5C	7EG	3.0	0.45	Class A Amplifier
★3BS2A	Half-Wave Rectifier	9B	12HY	3.15	0.48	Flyback Rectifiers in TV Receivers
3BU8	Sharp-Cutoff Twin Pentode	6E	9FG	3.15	0.6	Class A Amplifier (With both sections operating)
3BY6	Pentagrid Amplifier	5C	7CH	3.15	0.6	Class A Amplifier
★3CA3	Half-Wave Rectifier	14E	8MH	3.6	0.225	Pulsed Rectifier in TV Receivers
3CE5	Sharp-Cutoff Pentode	5C	7BD	3.15	0.6	Class A Amplifier
3CF6	Sharp-Cutoff Pentode	5C	7CM	3.15	0.6	Class A Amplifier
★3CN3A	Half-Wave Rectifier	14F	8MU	3.15	0.48	Flyback Rectifiers in TV Receivers
★3CX3	Half-Wave Rectifier	14G	8MT	3.15	0.48	Pulsed Rectifier in TV Receivers
★3DA3/ 3DH3	Half-Wave Rectifier	14G	8MY	3.15	0.48	Pulsed Rectifiers in TV Receivers
★3DR3	Half Wave Rectifier	29Q	8NL	3.15	0.3	Pulsed Rectifier in TV Receivers
★3DS3	Half-Wave Rectifier	29P	8NL	3.15	0.48	Pulsed Rectifier in TV Receivers
3DZ4	Medium-Mu Triode	5B	7DK	3.2	0.45	Class A Amplifier
3EA5	Sharp-Cutoff Tetrode	5C	7EW	2.9	0.45	Class A Amplifier
3EJ7	Sharp-Cutoff Pentode	6C	9AQ	3.4	0.6	Class A Amplifier
3FH5	High-Mu Triode	5C	7FP	3.0	0.45	Class A Amplifier
3GS8 3GS8/ 3BU8	Sharp-Cutoff Twin Pentode	6E	9LW	3.15	0.6	Class A Amplifier (With both sections operating)
3HA5	High-Mu Triode	5A	7GM	2.7	0.45	Class A Amplifier
3HS8	Sharp-Cutoff Twin Pentode	6E	9FG	3.15	0.6	Class A Amplifier (With both sections operating)
3JC6	Sharp-Cutoff Pentode	6B	9PM	3.5	0.6	Class A Amplifier
3JD6	Sharp-Cutoff Pentode	6B	9PM	3.5	0.6	Class A Amplifier
3LF4	Beam Power Tube	12B	6BA	1.4F 2.8F	0.1 0.05	Class A Amplifier
3Q4	Power Pentode	5C	7BA	1.4F 2.8F	0.1 0.05	Class A Amplifier
3Q5GT	Beam Power Tube	13D	7AP	1.4F 2.8F	0.1 0.05	Class A Amplifier
3S4	Power Pentode	5C	7BA	1.4F 2.8F	0.1 0.05	Class A Amplifier
3V4	Power Pentode	5C	6BX	1.4F 2.8F	0.1 0.05	Class A Amplifier
4BC5	Sharp-Cutoff Pentode	5C	7BD	4.2	0.45	Class A Amplifier
4BL8	Medium-Mu Triode— Sharp-Cutoff Pentode	6B	9DC	4.6	0.6	Triode Unit as Class A Amplifier Pentode Unit as Class A Amplifier
4BQ7A/ 4BZ7	Medium Mu Twin Triode	6B	9AJ	4.2	0.6	Each Unit as Class A Amplifier
4BS8	Medium-Mu Twin-Triode	6B	9AJ	4.6	0.6	Class A Amplifier
4BU8	Sharp-Cutoff Twin Pentode	6E	9FG	4.2	0.45	Class A Amplifier (With both sections operating)

★ See Safety Precautions at end of this section.

Plate Volts	Grid Bias or Cathode Resistor	Screen Grid Volts	Screen Grid Cur- rent mA	Plate Cur- rent mA	AC Plate Resist- ance Ohms	Trans- conduc- tance Micromhos	Amplifi- cation Factor	Power		RCA Type	
								Load Ohms	Out- put Watts		
				Max. Peak Inverse Plate Volts, 33000 Max. Peak Plate mA, 100				2		3BL2 3BL2A	
				Max. Peak Inverse Plate Volts, 33000 Max. Peak Plate mA, 100				2		3BM2	
				Max. Peak Inverse Plate Volts, 30000 Max. Peak Plate mA, 88				1.7		3BN2 3BN2A	
				For other characteristics, refer to Type 6BN4							3BN4
				Max. Peak Inverse Plate Volts, 38000 Max. Peak Plate mA, 110				2.2		3BS2A	
100	—	67.5	6.5	—	—	—	—	—	—	3BU8	
100	—	67.5	3.3	2.2	—	—	—	—	—	3BY6	
				For other characteristics, refer to Type 6BY6							3BY6
				Max. Peak Inverse Plate Volts, 30000 Max. Peak Plate mA, 100				2		3CA3	
				For other characteristics, refer to Type 6CE5							3CE5
				For other characteristics, refer to Type 6CF6							3CF6
				Max. Peak Inverse Plate Volts, 38000 Max. Peak Plate mA, 110				2.2		3CN3A	
				For other characteristics, refer to Type 3DA3/3DH3							3CX3
				Max. Peak Inverse Plate Volts, 38000 Max. Peak Plate mA, 110				2.2		3DA3/ 3DH3	
				Max. Peak Inverse Plate Volts, 38000 Max. Peak Plate mA, 100				2		3DR3	
				For other characteristics, refer to type 3DA3/3DH3							3DS3
				For other characteristics, refer to Type 2DZ4							3DZ4
250	—1V	140	0.95	10	150000	8000	—	—	—	3EA5	
190	— 2.35V	190	4.1	10	350000	15000	—	—	—	3E17	
200	— 2.5V	200	4.1	10	350000	15000	—	—	—	3E17	
				For other characteristics, refer to Type 6FH5							3FH5
				For other characteristics, refer to Type 4GS8/4BU8							3GS8/ 3BU8
135	87Ω	—	10	19	1000	20000	80	—	—	3HA5	
			—	11.5	5600	14500	72	—	—	3HA5	
100	—	67.5	7	—	—	—	—	—	—	3HS8	
100	—	67.5	4.4	2	—	—	—	—	—	3HS8	
125	56Ω	125	3.2	13	180000	15000	—	—	—	3JC6	
125	56Ω	125	3.4	14	180000	16000	—	—	—	3JC6	
				For other characteristics, refer to Type 6JD6							3JD6
				For other characteristics, refer to Type 3Q5GT							3LF4
				For other characteristics, refer to Type 3V4							3Q4
110	— 6.6V	110	1.4	10.0	100000	2200	—	8000	0.40	3Q5GT	
110	— 6.6V	110	1.1	8.5	110000	2000	—	8000	0.33	3Q5GT	
90	— 7V	67.5	1.4	7.4	100000	1575	—	8000	0.27	3S4	
90	— 7V	67.5	1.1	6.1	100000	1425	—	8000	0.235	3S4	
90	— 4.5V	90	2.1	9.5	100000	2150	—	10000	0.27	3V4	
90	— 4.5V	90	1.7	7.7	120000	2000	—	10000	0.24	3V4	
250	180Ω	150	2.1	7.5	800000	5700	—	—	—	4BC5	
				For other characteristics, refer to Type 6BL8							4BL8
				For other characteristics, refer to Type 6BQ7A							4BQ7A/ 4BZ7
				For other characteristics, refer to Type 3BU8							4BS8
				For other characteristics, refer to Type 6BS8							4BU8

RCA Type	Name	Out- line	Terminal Dia- gram	Heater or Filament (F)		Use Values to right give operat- ing conditions and character- istics for indicated typical use
				Volts	Amperes	
4BZ7	Medium-Mu Twin Triode	63	9AJ	4.2	0.6	Each Unit as Class A Amplifier
4CY5	Sharp-Cutoff Tetrode	5C	7EW	4.5	0.3	Class A Amplifier
4DT6	Sharp-Cutoff Pentode	5C	7EN	4.2	0.45	Class A Amplifier
4EH7	Semiremote-Cutoff Pentode	6C	9AQ	4.4	0.45	Class A Amplifier
4EJ7	Sharp-Cutoff Pentode	6C	9AQ	4.4	0.45	Class A Amplifier
4ES8	Variable-Mu Twin-Triode	6B	9AJ	4	0.6	Each Unit as Class A Amplifier Cascode-Type Amplifier
4ES8/ XCC189	Variable-Mu Twin Triode	6B	9AJ	4	0.6	Each Unit as Class A Amplifier
4EW6	Sharp-Cutoff Pentode	5C	7CM	4.2	0.6	Class A Amplifier
4GM6	Semiremote-Cutoff Pentode	5C	7CM	4.2	0.6	Class A Amplifier
4GS8	Sharp-Cutoff Pentode	6E	9LW	4.2	0.45	Class A Amplifier
4GS8/ 4BU8	Sharp-Cutoff Twin Pentode	6E	9LW	4.2	0.45	Class A Amplifier (With both sections operating)
4GX7	Medium-Mu Triode— Sharp-Cutoff Pentode	6B	9QA	4.2	0.6	Triode Unit as Class A Amplifier Pentode Unit as Class A Amplifier
4GZ5	Power Pentode	5C	7CV	4	0.6	Class A Amplifier
4HA5/ PC900	High-Mu Triode	5A	76M	3.9	0.3	Class A Amplifier
4HA7	Dual Triode	8A	12FQ	4.2	0.6	Each Unit as Class A Amplifier
4HA7/ 4HC7	Dual Triode	8A	12FQ	4.2	0.6	Class A Amplifier
4HC7	Dual Triode	30E	12FR	4.2	0.6	Each Unit as Class A Amplifier
4HM6	Sharp-Cutoff Pentode	6B	9PM	4.2	0.45	Class A Amplifier
4HT6	Semiremote-Cutoff Pentode	6B	9PM	4.2	0.45	Class A Amplifier
4JC6	Sharp-Cutoff Pentode	6B	9PM	4.5	0.45	Class A Amplifier
4KN8/ 4RHH8	Medium-Mu Twin-Triode	6B	9AJ	4.2	0.6	Class A Amplifier
4LUG	Sharp-Cutoff Pentode	5C	7CM	4.2	0.6	Class A Amplifier
5AS4	Full-Wave Rectifier	27A	5T	5.0F	3.0	With Capacitive-Input Filter
5AS8	Diode—Sharp-Cutoff Pentode	6B	9DS	4.7	0.6	Class A Amplifier
5AU4	Full-Wave Rectifier	19G	5T	5.0F	3.75	With Capacitive-Input Filter With Inductive-Input Filter
5AV8	Medium-Mu Triode— Sharp-Cutoff Pentode	6B	9DZ	4.7	0.6	Triode Unit as Class A Amplifier Pentode Unit as Class A Amplifier
5AW4	Full-Wave Rectifier	19H	5T	5.0F	3.7	Rectifier
5AZ4	Full-Wave Rectifier	12C	5T	5.0F	2.0	
5B8	Medium-Mu Triode— Sharp-Cutoff Pentode	6B	9EC	4.7	0.6	Triode Unit as Class A Amplifier Pentode Unit as Class A Amplifier
						With Capacitive-Input Filter
5BC3	Full-Wave Rectifier	17C	9QJ	5F	3	With Inductive-Input Filter
5BE8	Medium-Mu Triode—Sharp-Cutoff Pentode	6B	9EG	4.7	0.6	Triode Unit as Class A Amplifier Pentode Unit as Class A Amplifier

Plate Volts	Grid Bias or Cathode Resistor	Screen Grid Volts	Screen Grid Cur- rent mA	Plate Cur- rent mA	AC Plate Resist- ance Ohms	Trans- conduct- ance Micromhos	Amplifi- cation Factor	Power		VCA Type
								Load Ohms	Out- put Watts	
For other characteristics, refer to Type 6BZ7										4BZ7
125	— 1V	80	1.5	10	100000	8000	—	—	—	4CY5
150	56Ω	100	2.1	1.1	150000	515	—	—	—	4DT6
200	— 2	90	4.5	12	0.5	12500	—	—	—	4EH7
200	— 2.5	200	4.1	10	0.3	15000	—	—	—	4EJ7
For other characteristics, refer to Type 6ES8										4ES8
For other characteristics, refer to Type 6ES8/ECC189										4ES8/ XCC189
For other characteristics, refer to Type 6EW6										4EW6
For other characteristics, refer to Type 6GM6										4GM6
For other characteristics, refer to Type 4GS8/4BU8										4GS8
100	—	67.5	6.0	—	Grid-No. 3 volts, each section, —10				—	4GS8/ 4BU8
100	—	67.5	6.0	2.0	Grid-No. 3 volts, each section, 0				—	4GS8/ 4BU8
: Grid current adjusted for 100 microamperes DC										
For other characteristics, refer to Type 5GX7										4GX7
For other characteristics, refer to Type 6GZ5										4GZ5
135	— 1V	—	—	11.5	—	14500	72	—	—	4HA5/ PC900
135	0Ω	—	—	19	—	20000	80	—	—	4HA5/ PC900
250	— 8.5	—	—	10.5	7700	2200	17	—	—	4HA7
250	— 2	—	—	1.2	62500	1600	100	—	—	4HA7
For other characteristics, refer to Type 4HA7										4HA7/ 4HC7
150	— 1	—	—	18	5200	4400	23	—	—	4HC7
150	— 1	—	—	1	53000	1900	100	—	—	4HC7
For other characteristics, refer to Type 6HM6										4HM6
125	56Ω	125	4	15	143000	14000	—	—	—	4HT6
For other characteristics, refer to Type 6JC6										4JC6
For other characteristics, refer to Type 6KN8/6RHH8										4KN8/ 4RHH8
250	820Ω	250	2.3	9	280000	3900	—	—	—	4LU6
50	65Ω	250	15	40	—	—	—	—	—	4LU6
Max. AC Volts per Plate (RMS), 550 Max. Peak Inverse Volts, 1550										5AS4
Max. DC Output mA, 300 Max. Peak Plate mA, 1000										5AS4
Min. Total Effect. Supply Imped. per Plate, 97 ohms										5AS4
For other characteristics, refer to Type 6AS8										5AS8
Max. DC Output mA, 325 for AC Volts per Plate, 400 and Total Effect. Supply Imped. per Plate, 50 ohms										5AU4
Max. Peak Inverse Volts, 1400										5AU4
Max. DC Output mA, 325 for AC Volts per Plate, 500 and Input Choke 10 henries Max. Peak Plate mA per Plate, 1075										5AU4
200	— 6V	—	—	13	5750	3300	19	—	—	5AV8
200	180Ω	150	2.8	9.5	300000	6200	—	—	—	5AV8
Max. Peak Inverse Volts, 1550										5AW4
Max. Peak Plate mA per Plate, 750										5AW4
For ratings and characteristics, refer to Type 5Y3GT										5AZ4
200	— 6V	—	—	13	5750	3300	19	—	—	5B8
200	180Ω	150	2.8	9.5	300000	6200	—	—	—	5B8
Max. AC Volts per Plate (RMS), 500 Max. Peak Inverse Volts, 1700										5BC3
Max. DC Output mA, 150 Max. Peak Plate mA per Plate, 1000										5BC3
Min. Total Effect. Supply Imped. per Plate, 21 ohms										5BC3
Max. AC Volts per Plate (RMS), 600 Max. Peak Inverse Volts, 1700										5BC3
Max. DC Output mA, 150 Max. Peak Plate mA per Plate, 1000										5BC3
Min. Value of Input Choke, 10 henries										5BC3
150	56Ω	—	—	18	5000	8500	40	—	—	5BE8
250	68Ω	110	3.5	10	400000	5200	—	—	—	5BE8

RCA Type	Name	Out-line	Terminal Diagram	Heater or Filament (F)		Use Values to right give operating conditions and characteristics for indicated typical use
				Volts	Amperes	
5BT8	Twin-Diode—Sharp-Cutoff Pentode	6B	9FE	4.7	0.6	Class A Amplifier
5BW8	Twin-Diode—Sharp-Cutoff Pentode	6B	9HK	4.7	0.6	Pentode Unit as Class A Amplifier
5CL8	Medium-Mu Triode—	6B	9FX	4.7	0.6	Triode Unit as Class A Amplifier
5CM8	High-Mu Triode—Sharp-Cutoff Pentode	6B	9FZ	4.7	0.6	Triode Unit as Class A Amplifier Pentode Unit as Class A Amplifier
5CQ8	Medium-Mu Triode—Sharp-Cutoff Pentode	6B	9GE	4.7	0.6	Class A Amplifier
5DH8	High-Mu Triode—Sharp-Cutoff Pentode	6B	9EG	5.2	0.6	Triode Unit as Class A Amplifier Pentode Unit as Class A Amplifier
5DJ4	Full-Wave Rectifier	19E	8KS	5.0	3.0	With Capacitive-Input Filter With Inductive-Input Filter
5ES8 5ES8/ YCC189	Variable-Mu Twin-Triode	6B	9AJ	5.6	0.45	Each Unit as Class A Amplifier Cascade Type Amplifier
5EU8	Medium-Mu Triode—Sharp-Cutoff Pentode	6B	9JF	4.7	0.6	Class A Amplifier
5FV8	Medium-Mu Triode Sharp-Cutoff Pentode	6B	9FA	4.7	0.6	Class A Amplifier
5GJ7	Medium-Mu Triode Sharp-Cutoff Pentode	6J	9QA	5.6	0.45	Triode Unit as Class A Amplifier Pentode Unit as Class A Amplifier
5GX6	Sharp-Cutoff Pentode	5C	7EN	4.7	0.6	Class A Amplifier
5GX7	Medium-Mu Triode—Sharp-Cutoff Pentode	6B	9QA	5.6	0.45	Triode Unit as Class A Amplifier Pentode Unit as Class A Amplifier
5HA7	Dual Triode	8A	12FQ	5.6	0.45	Each Unit as Class A Amplifier
5HG8	Medium-Mu Triode—Sharp-Cutoff Pentode	6B	9MP	5.3	0.45	Triode Unit as Class A Amplifier Pentode Unit as Class A Amplifier
5JK6	Sharp-Cutoff Pentode	5C	7CM	4.9	0.45	Class A Amplifier
5JL6	Semiremote-Cutoff Pentode	5C	7CM	4.9	0.45	Class A Amplifier
5T4	Full-Wave Rectifier	4	5T	5.0F	2.0	With Capacitive-Input Filter With Inductive-Input Filter
5U4G	Full-Wave Rectifier	27B	5T	5.0F	3.0	With Capacitive-Input Filter
5U9/ LCF201	Medium-Mu Triode—Sharp-Cutoff Pentode	6B	10K	5.9	0.45	Class A Amplifier
5V3	Full-Wave Rectifier	19E	5T	5.0F	3.8	With Capacitive-Input Filter With Inductive Input Filter
5V4G	Full-Wave Rectifier	25	5L	5	2	With Capacitive-Input Filter With Inductive-Input Filter

Plate	Grid Bias or Cathode Resistor	Screen Grid	Screen Grid Current	Plate Current	AC Plate Resistance	Trans-conductance	Amplification Factor	Power		RCA Type
								Load	Output	
Volts		Volts	mA	mA	Ohms	Micromhos		Ohms	Watts	
200	180Ω	150	2.8	9.5	300000	6200	—	—	—	5B78
For other characteristics, refer to Type 6BWB										5BWB
125	— 1V	—	—	14	5000	8000	40	—	—	5C18
For other characteristics, refer to Type 6CM8										5CM8
For other characteristics, refer to Type 6CQ8										5CQ8
250	390Ω	—	—	7.3	12000	4400	53	—	—	5D8
125	56Ω	125	3.8	13.5	150000	8600	—	—	—	5DH8
AC Volts per Plate (RMS), 450 Max. Peak Inverse Volts, 1700				DC Output mA, 275 Max Peak Plate mA, 1000			Min. Total Effect. Supply Imp. per Plate, 67 ohms			5DJ4
AC Volts per Plate (RMS), 550 Max. Peak Inverse Volts, 1700				DC Output mA, 275 Max Peak Plate mA, 1000			Min. Value of Input Choke, 10 henries			
For other characteristics, refer to Type 6E88/ECC189										5E88 5E88/ YCC189
For other characteristics, refer to Type 6EU8										5EU8
For other characteristics, refer to Type 6FV8A										5FV8
100	— 3	—	—	15	—	9000	20	—	—	
170	— 1.2	120	3	10	0.35	11000	55	—	—	5GJ7
150	180Ω	100	3	3.7	140000	3700 (Grid-No. 1 to Plate) 750 (Grid-No. 3 to Plate)	—	—	—	5GX6
100	—	—	—	12.5	—	8700	40	—	—	
125	— 1V	—	—	13	4700	8500	—	—	—	5GX7
120	—	90	2.8	8.5	—	13000	—	—	—	
125	— 1V	125	2.5	8	200000	11000	—	—	—	
For other characteristics, refer to Type 4HA7										5HA7
For other characteristics, refer to Type 6HG8										5HG8
For other characteristics, refer to Type 6JK6										5JK6
125	56Ω	60	4	12.5	120000	15500	—	—	—	5JL6
Max. AC Volts per Plate (RMS), 450 Max. Peak Inverse Volts, 1550				Max. DC Output mA, 225 Max. Peak Plate mA, 675			Min. Total Effect. Supply Imped. per Plate, 150 ohms			5T4
Max. AC Volts per Plate (RMS), 550 Max. Peak Inverse Volts, 1550				Max. DC Output mA, 225 Max. Peak Plate mA, 675			Min. Value of Input Choke, 10 henries			
Max. AC Volts per Plate (RMS), 450 Max. Peak Inverse Volts, 1550				Max. DC Output mA, 225 Max. Peak Plate mA, 675			Min. Total Effect. Supply Imped. per Plate, 170 ohms			5U4G
For other characteristics, refer to Type 6U9/ECF201										5U9/ LCF201
Max. AC Volts per Plate (RMS), 425 Max. Peak Inverse Volts, 1400				Min. Total Effect. Supply Imped. per Plate, 56 ohms			Max. DC Output mA, 350 Max. Peak Plate mA per Plate, 1200			5V3
Max. AC Volts per Plate (RMS), 500 Max. Peak Inverse Volts, 1400				Min. Value of Input Choke, 10 henries			Max. DC Output mA, 350 Max. Peak Plate mA per Plate, 1200			
Max. AC Volts per Plate (RMS), 375 Max. Peak Inverse Volts, 1400				Min. Total Effect. Supply Imped. per Plate, 100 ohms			Max. DC Output mA, 175 Max. Peak Plate mA per Plate, 525			5V4G
Max. AC Volts per Plate (RMS), 500 Max. Peak Inverse Volts, 1400				Min. Value of Input Choke, 4 henries			Max. DC Output mA, 175 Max. Peak Plate mA per Plate, 525			

RCA Type	Name	Out- line	Terminal Dia- gram	Heater or Filament (F)		Use Values to right give operat- ing conditions and character- istics for indicated typical use
				Volts	Amperes	
5V6GT	Beam Power Tube	13D	7AC	4.7	0.6	Class A Amplifier
5W4	Full-Wave Rectifier	2B	5T	5.0F	1.5	With Capacitive-Input Filter
5W4GT		13E	5T			
5X4G	Full-Wave Rectifier	27B	5Q	5.0F	3.0	
5Y4G	Full-Wave Rectifier	25	5Q	5.0F	2.0	
5Y4GA		19E	5Q			
5Y4GT		13E	5Q			
5Z3	Full-Wave Rectifier	27B	4C	5.0F	3.0	
5Z4	Full-Wave Rectifier	2B	5L	5.0	2.0	With Capacitive-Input Filter
						With Inductive-Input Filter
6A3	Power Triode	27B	4D	6.3F	1.0	Amplifier
6A6	High-Mu Twin Power Triode	2B	7B	6.3	0.8	Amplifier
6A7	Pentagrid Converter	24B	7C	6.3	0.3	Converter
6A7S		24B				
6A8	Pentagrid Converter	3	8A	6.3	0.3	Converter
6A8G		23	8A			
6A8GT		14A	8A			
6AB5/ 6N5	Electron-Ray Tube	22 or 13H	6R	6.3	0.15	Visual Indicator
6AB7	Sharp-Cutoff Pentode	2A	8N	6.3	0.45	Class A Amplifier
						Class B Amplifier
6AC5GT	High-Mu Power Triode	13D	6Q	6.3	0.4	Dynamic-Coupled Amplifier With 76 Driver
6AC7	Sharp-Cutoff Pentode	2A	8N	6.3	0.45	Class A Amplifier
6AD6G	Electron-Ray Tube	29E	7AG	6.3	0.15	Visual Indicator
6AD7G	Low-Mu Triode—Power Pentode	25	8AY	6.3	0.85	Triode Unit as Class A Amplifier Pentode Unit as Class A Amplifier
6AE5GT	Low-Mu Triode	13D	8Q	6.3	0.3	Class A Amplifier
6AE6G	Twin-Plate Control Tube	22	7AH	6.3	0.15	Remote Cutoff Triode
						Sharp-Cutoff Triode
6AE7GT	Twin-Input Triode	13D	7AX	6.3	0.5	Class A Amplifier
6AG7Y ⁴	Power Pentode	2B	8Y	6.3	0.65	Class A Amplifier
6AG11	Twin Diode—Twin Triode	8A	12DA	6.3	0.75	Each Triode as Class A Amplifier
6AH4GT	Low-Mu Triode	13D	8EL	6.3	0.75	Vertical Deflection Amplifier
6AH6	Sharp-Cutoff Pentode	5C	7BK	6.3	0.45	Class A Amplifier
6AH9	Medium-Mu Triode— Sharp-Cutoff Pentode	8B	12HJ	6.3	0.9	Triode Unit as Class A Amplifier
						Pentode Unit as Class A Amplifier
6AJ8/ ECH81	Triode-Heptode Converter	9CA	6E	6.3	0.3	Triode Unit as Oscillator Heptode Unit as Mixer
6AK8/ EABC80	Triple Diode— High-Mu Triode	6E	9E	6.3	0.45	Triode Unit as Class A Amplifier
6AK10	High-Mu Triple Triode	8C	12FE	6.3	0.9	Each Unit as Class A Amplifier
6AL3	Half-Wave Rectifier	7D	9CB	6.3	1.55	Television Damper Service

Plate	Grid Bias or Cathode Resistor	Screen Grid	Screen Grid Current	Plate Current	AC Plate Resistance	Trans-conductance	Amplification Factor	Power		RCA Type
								Load	Output	
Volts		Volts	mA	mA	Ohms	Micromhos		Ohms	Watts	
For other characteristics, refer to Type 6V6GT										5V6GT
Max. Peak Inverse Volts, 1400				Max. DC Output mA, 100			Max. Peak Plate mA, 300			5W4 5W4GT
For other ratings, refer to Type 5U4G										5X4G
Max. Peak Plate mA, 375 (5Y4G)				For other ratings, refer to Type 5Y3G						5Y4G
Max. Peak Plate mA, 400 (5Y4GA, 5Y4GT)										5Y4GA 5Y4GT
For other ratings, refer to Type 5U4G										5Z3
Max. AC Volts per Plate (RMS), 350				Max. DC Output mA, 125			Min. Total Effect Supply Imped. per Plate, 50 ohms			5Z4
Max. Peak Inverse Volts, 1400				Max. Peak Plate mA, 375						
Max. AC Volts per Plate (RMS), 500				Max. DC Output mA, 125			Min. Value of Input Choke, 5 henries			6A3
Max. Peak Inverse Volts, 1400				Max. Peak Plate mA, 375						
For other characteristics, refer to Type 6B4G										6A6
For other characteristics, refer to Type 6N7GT										6A7 6A7S
For other characteristics, refer to Type 6A8										6A8 6A8G 6A8GT
250	- 3V	100	2.7	3.5	360000	Anode-Grid (2): 250 max. V, 4.0 mA Oscillator-Grid (1) Res. Conversion Transcond., 550 μmhos				
Plate & Target Supply = 135 volts. Triode Plate Resistor = 0.25 MΩ Target Current = 2.0 mA Grid Bias, - 10.0 volts; Shadow Angle, 0°. Bias, 0 volts; Angle, 90°; Plate Current, 0.5 mA.										6AB5/ 6N5
Plate & Target Supply = 135 volts. Triode Plate Resistor = 1.0 MΩ Target Current = 1.9 mA Grid Bias, - 15.5 volts; Shadow Angle, 0°. Bias, 0 volts; Angle, 90°; Plate Current, 0.13 mA										
300	- 3V	200	3.2	12.5	700000	5000				6AB7
250	0V			5.0				10000	8.0†	
250	Bias for both 6AC5GT and 76 is developed in coupling circuit Average Plate Current of Driver = 5.5 milliamperes Average Plate Current of 6AC5GT = 32 milliamperes							7000	3.7	6AC5GT
300	160Ω	150	2.5	10.0	1 M	9000				6AC7
Target Voltage, 150 volts. Control-Electrode Voltage, -50 volts; Shadow Angle, 135°; Target Current, 1.2 mA Control-Electrode Voltage, 75 volts; Angle, 0°; Target Current, 3 mA										6AD6G
250	-25V			3.7	19000	325	6			6AD7G
250	-16.5V	250	6.5	34.0	80000	2500		7000	3.2	
95	-15V			7.0	3500	1200	4.2			6AE5GT
250	- 1.5V			6.5	25000	1000	25			6AE6G
250	-35V			0.01						
250	- 1.5V			4.5	35000	950	33			6AE7GT
250	- 9.5V			0.01						
250	-13.5V			10.0	4650	3000	14			
For other characteristics, refer to Type 6AG7										6AG7Y*
125	-1V			7.5	8500	7800	66			6AG11
Max. DC Plate Volts, 500				Max. Peak Positive-Pulse Plate Volts, 2000						6AH4GT
Max. DC Cathode mA, 60				Max. Plate Dissipation, 7.5 watts						
300	160Ω	150	2.5	10.0	500000	9000				6AH6
250	-9V			8	7300	2750	20			6AH9
250	122Ω	150	6	25	5500	21000				
50	0	125	32	76						
250	Grid Res., 47000 ohms			4.5			Oscillator Grid Current, 200 μA			6AJ8/ ECH81
250	-2V		6.7	3.25	1M	Conversion Transcond., 775 micromhos				
250	-3V			1	58000	1200	70			6AK8/ EABC80
100	-1V			0.8	54000	1300	70			
200	230Ω			10	7500	7000	53			6AK10
Max. Peak Inverse Plate Volts, 7500 (Abs.)				Max. Plate Dissipation, 5 watts						6AL3
Max. Peak Plate mA, 550				Max. Peak Heater-Cathode Volts, 6600						
Max. DC Plate mA, 220										

† For two tubes at stated plate-to-plate load.

□ For two tubes.

RCA Type	Name	Out- line	Terminal Dia- gram	Heater or Filament (F)		Use Values to right give operat- ing conditions and character- istics for indicated typical use
				Volts	Amperes	
6AL7GT	Electron-Ray Tube	13C	8CH	6.3	0.15	Visual Indicator
6AM4	High-Mu Triode	6A	9BX	6.3	0.225	Class A Amplifier
6AM8	Diode—Sharp-Cutoff Pentode	6B	9CY	6.3 6.3	0.45 0.45	Diode Unit Pentode Unit as Class A Amplifier
6AN4	High-Mu Triode	5B	7DK	6.3	0.225	Class A Amplifier
6AN5*	Beam Power Tube	5C	7BD	6.3	0.45	Class A Amplifier
6AN8	Medium-Mu Triode—Sharp-Cutoff Pentode	6B	9DA	6.3 6.3	0.45 0.45	Triode Unit as Class A Amplifier Pentode Unit as Class A Amplifier
6AQ5	Beam Power Tube	5D	7BZ	6.3 6.3	0.45 0.45	Single Tube Class A Amplifier Push-Pull Class A ₁ Amplifier
6AQ6	Twin-Diode—High-Mu Triode	5C	7BT	6.3	0.15	Triode Unit as Class A Amplifier
6AQ7GT	Twin-Diode—High-Mu Triode	13D	8CK	6.3	0.3	Triode Unit as Class A Amplifier
6AQ8	High-Mu Twin Triode	6B	9AJ	6.3	0.435	Each Unit as Class A Amplifier
6AR5	Power Pentode	5D	6CC	6.3	0.4	Class A Amplifier
6AR8	Beam-Deflection Tube	6E	9DP	6.3	0.3	Color TV Demodulator
6AS6*	Dual Control RF Pentode	5B	7CM	6.3	0.175	Class A Amplifier
6AS7GA*	Low-Mu Twin Triode	19E	8BD	6.3	2.5	Voltage Regulator
6AS11	Dual Triode—Sharp-Cutoff Pentode	8B	12DP	6.3	1.05	Dual Triode Unit as Class A Amplifier Pentode Unit as Class A Amplifier
6AT8	Medium-Mu Triode	6B	9DW	6.3	0.45	Triode Unit as Class A Amplifier
6AU4GT	Half-Wave Rectifier	13G	4CG	6.3	1.8	Television Damper Service
6AU6	Sharp-Cutoff Pentode	5C	7BK	6.3 6.3	0.3 0.3	Class A Amplifier
6AU7	Medium-Mu Twin Triode	6B	9A	3.15 6.3	0.6 0.3	Each Unit as Class A Amplifier
6AU8	Medium-Mu Triode—Sharp-Cutoff Pentode	6E	9DX	6.3	0.6	Triode Unit as Class A Amplifier Pentode Unit as Class A Amplifier
6AV5GT	Beam Power Tube	13D	6CK	6.3	1.2	Horizontal Deflection Amplifier
6AV11	Medium-Mu Triple Triode	8A	12BY	6.3	0.6	Each Unit as Class A Amplifier
6AW8	High-Mu Triode—Sharp-Cutoff Pentode	6E	9DX	6.3	0.6	Triode Unit as Class A Amplifier Pentode Unit as Class A Amplifier
6AX4GT	Half-Wave Rectifier	13D	4CG	6.3	1.2	Television Damper Service
6AX8	Medium-Mu Triode—Semiremote Cutoff Pentode	6B	9AE	6.3	0.45	Triode Unit as Class A Amplifier Pentode Unit as Class A Amplifier
6AY3	Half-Wave Rectifier	11D	9HP	6.3	1.2	Television Damper Service
6AY11	Twin Diode—High-Mu Twin Triode	8A	12DA	6.3	0.69	Each Triode Unit as Class A Amplifier
6B4G	Power-Triode	27B	5S	6.3F	1.0	Class A Amplifier
6B5	Direct-Coupled Power Triode	26	6AS	6.3	0.8	Class A Amplifier
6B6G	Twin-Diode—High-Mu Triode	23	7V	6.3	0.3	Triode Unit as Amplifier

* Industrial type

Plate Volts	Grid Bias or Cathode Resistor	Screen Grid Volts	Screen Grid Cur- rent mA	Plate Cur- rent mA	AC Plate Resist- ance Ohms	Trans- conduct- ance Micromhos	Amplifi- cation Factor	Power		RCA Type
								Load Ohms	Out- put Watts	
Target Voltage, 315 volts Grid Voltage = 0 volts Cathode Bias Res., 3300 ohms approx.					Grid Voltage for Pattern Cutoff, -7 volts approx. Deflecting-Electrodes—No. 1, No. 2 and No. 3 Voltage, 0					6AL7GT
200	100Ω	—	—	10	8700	9800	85	—	—	6AM4
Max. DC Plate mA, 5				Max. Peak Heater-Cathode Volts, ±200						6AM8
125	56Ω	125	3.2	12.5	—	7800	—	—	—	6AN4
200	100Ω	—	—	13	7000	10000	70	—	—	6AN4
120	120Ω	120	12	35	12500	8000	—	2500	1.3	6AN5†
150	-3V	—	—	15	4500	4700	31	—	—	6AN8
125	56Ω	125	3.8	12	170000	7800	—	—	—	6AN8
180	-8.5V	180	3.0	29.0	50000	3700	—	5500	2.0	6AQ5
250	-12.5V	250	4.5	45.0	50000	4100	—	5000	4.5	6AQ5
250	-15V	250	5.0□	70.0□	60000	—	—	10000	10.0†	6AQ5
100	-1V	—	—	0.8	61000	1150	70	—	—	6AQ6
250	-3V	—	—	1.0	58000	1200	70	—	—	6AQ6
250	-2V	—	—	2.3	44000	1600	70	—	—	6AQ7GT
250	-2.3V	—	—	10	—	5900	57	—	—	6AQ8
250	-18V	250	5.5	32.0	90000	2300	—	7600	3.4	6AR5
250	300Ω	250	—	10	—	4000	—	—	—	6AR8
120	-2V	120	3.5	5.2	110000	3200	—	(EC3 = 0V)	—	6AS6†
For other characteristics, refer to Type 6AS7G										6AS7GA†
200	220Ω	—	—	9.2	4400	4400	41	—	—	6AS11
200	-2V	—	—	7	12400	5500	68	—	—	6AS11
200	125	125	5.2	24	70000	10500	—	—	—	6AT8
125	-1V	—	—	12	6000	6500	40	—	—	6AT8
Max. Peak Inverse Plate Volts, 4500 (Absolute)					Max. Average Plate mA, 175					6AU4GT
Max. Peak Plate mA, 1050					Max. Plate Dissipation 6.0 watts					6AU6
100	150Ω	100	2.1	5.0	500000	3900	—	—	—	6AU6
250	68Ω	150	4.3	10.6	1 M	5200	—	—	—	6AU6
100	0V	—	—	11.8	6250	3500	19.5	—	—	6AU7
250	-8.5V	—	—	10.5	7700	2200	17	—	—	6AU7
150	150Ω	—	—	9	8200	4900	40	—	—	6AU8
200	82Ω	125	3.4	15	150000	7000	—	—	—	6AU8
Max. DC Plate Volts, 550					Max. Peak Positive-Pulse Plate Volts, 5500 (Abs.)					6AV5GT
Max. DC Cathode mA, 110					Max. Plate Dissipation, 11 watts					6AV11
250	-8.5V	—	—	10.5	7700	2200	17	—	—	6AV11
100	0V	—	—	11.8	6500	3100	20	—	—	6AV11
200	-2V	—	—	4	—	4000	70	—	—	6AW8
150	150Ω	150	3.5	13	200000	9500	—	—	—	6AW8
6AW8A Features a plate current characteristic with a controlled knee										
Max. Peak Inverse Plate Volts, 4400					Max. Peak Heater-Cathode Volts: { -4400**					6AX4GT
Max. Peak Plate mA, 750					+300					6AX4GT
Max. DC Plate mA, 125					**DC component must not exceed 900 volts					6AX8
150	560Ω	—	—	18	5000	8500	40	—	—	6AX8
250	120Ω	110	3.5	10	400000	4800	—	—	—	6AX8
Max. Peak Inverse Plate Volts, 5000					Max. Plate Dissipation, 6.5 watts					6AY3
Max. Peak Plate mA, 1100					Max. Peak Heater-Cathode Volts: { -5000					6AY3
Max. DC Plate mA 175					+300					6AY3
250	-2V	—	—	1.2	52700	1900	100	—	—	6AY11
250	-45V	—	—	60	800	5250	4.2	2500	3.5	6B4G
For other characteristics, refer to Type 6N6G										6B5
For other characteristics, refer to Type 6SQ7										6B6G

† For two tubes at stated plate to plate load.

□ For two tubes.

RCA Type	Name	Out- line	Terminal Dia- gram	Heater or Filament (F)		Use Values to right give operat- ing conditions and character- istics for indicated typical use
				Volts	Amperes	
6B7 6B7S	Twin-Diode—Remote-Cutoff Pentode	24B 24B	7D	6.3	0.3	Pentode Unit as Amplifier
6B8	Twin-Diode—Semiremote-Cutoff Pentode	3	8E	6.3	0.3	Pentode Unit as Amplifier
6B8G	Twin Diode—Semiremote-Cutoff Pentode	23	8E	6.3	0.3	Pentode Unit as Class A Amplifier
6BA3	Half-Wave Vacuum Rectifier	30B	9HP	6.3	1.2	Television Damper Service
6BC5	Sharp-Cutoff Pentode	5C	7BD	6.3	0.3	Class A Amplifier
6BC7	Triple Diode	6B	9AX	6.3	0.45	Each Unit—Half-Wave Rectifier
★6BD4	Sharp-Cutoff Beam Triode	21C	8FU	6.3	0.6	Voltage-Control
★6BD4A	Sharp-Cutoff Beam Triode	21C	8FU	6.3	0.6	Voltage-Control
6BD6	Remote-Cutoff Pentode	5C	7BK	6.3	0.3	Class A Amplifier
6BD11	Dual Triode— Sharp-Cutoff Pentode	8B	12DP	6.3	1.05	Triode No. 1 as Class A Amplifier Triode No. 2 as Class A Amplifier Pentode Unit as Class A Amplifier
6BF5	Beam Power Tube	5D	7BZ	6.3	1.2	Class A Amplifier
6BF6	Twin-Diode—Medium-Mu Triode	5C	7BT	6.3	0.3	Triode Unit as Class A Amplifier
6BG6G 6BG6GA	Beam Power Tube	28B 21B	5BT 5BT	6.3	0.9	Horizontal Deflection Amplifier
6BH3 6BH3A	Half-Wave Rectifier	11D	8HP	6.3	1.6	Television Damper Service
6BH8	Medium-Mu Triode— Sharp-Cutoff Pentode	6E	9DX	6.3	0.6	Triode Unit as Class A Amplifier Pentode Unit as Class A Amplifier
6BJ3	Half-Wave Rectifier	8C	12BL	6.3	1.2	Television Damper Service
6BJ6A	Remote-Cutoff Pentode	5C	7CM	6.3	0.15	Class A Amplifier
6BJ7	Triple Diode	6B	9AX	6.3	0.45	Each Unit—Half-Wave Rectifier
6BK4 ★6BK4A	Beam Triode	21B	8GC	6.3	0.2	Voltage-Control
★6BK4B	Beam Triode	21B	8GC	6.3	0.2	Shunt Voltage Regulator
6BK5	Beam Power Tube	6E	9BQ	6.3	1.2	Class A Amplifier
6BK7A	Medium-Mu Twin Triode	6B	9AJ	6.3 6.3	0.45 0.45	Each Unit as Class A Amplifier
6BL4	Half-Wave Rectifier	13F	8GB	6.3	3.0	Television Damper Service
6BL7GT	Medium-Mu Twin Triode	13D	8BD	6.3	1.5	Vertical Deflection Amplifier
6BL8	Medium-Mu Triode— Sharp-Cutoff Pentode	6B	9DC	6.3	0.45	Triode Unit as Class A Amplifier Pentode Unit as Class A Amplifier
6BN4	Medium-Mu Triode	5C	7EG	6.3	0.2	Class A Amplifier
6BN6	Beam Tube	5D	7DF	6.3	0.3	Limiter and Discriminator
6BQ6GT	Beam Power Tube	14D	6AM	6.3	1.2	Horizontal Deflection Amplifier
6BQ7	Medium-Mu Twin Triode	6B	9AJ	6.3	0.4	Each Unit as Class A Amplifier
6BR8	Medium-Mu Triode—Sharp-Cutoff Pentode	6B	9FA	6.3 6.3	0.45 0.45	Triode Unit as Class A Amplifier Pentode Unit as Class A Amplifier

★ See Safety Precautions at end of this section.

Plate	Grid Bias or Cathode Resistor	Screen Grid	Screen Grid Current	Plate Current	AC Plate Resistance	Trans-conductance	Amplification Factor	Power		RCA Type
								Load	Output	
Volts	Volts	mA	mA	Ohms	Micramhos	Ohms	Watts			
Input Triode: Output Triode:	Plate Volts, 300 max; Plate Volts, 300 max.;	Grid Volts, 0; Plate mA, 8;	AF Signal Volts (Peak), 21							6B7 6B7S
			7000 ohms; Power Output, 4 watts							6B8
For other characteristics, refer to Type 12C8										6B8
250	-3V	125	2.3	9	600000	1125	—	—	—	6B8G
										6BA3
										6BC5
										6BC7
										6BD4
										6BD4A
250	-3V	100	3.0	9.0	800000	2000	—	—	—	6BD6
200	-2V	—	—	7	12400	5500	68	—	—	6BD11
200	220Ω	—	—	9.2	9400	4400	41	—	—	6BF5
135	100Ω	135	4	17	45000	10400	—	—	—	6BF6
110	-7.5V	110	4.0	36.0	12000	7500	—	2500	1.9	6BG6G
250	-9V	—	—	9.5	8500	1900	16	Power Output, 300 milliwatts		6BG6GA
										6BH3
										6BH3A
150	-5V	—	—	9.5	5150	3300	17	—	—	6BH8
200	82Ω	125	3.4	15	150000	7000	—	—	—	6BJ3
										6BJ6A
										6BJ7
										6BK4
										6BK4A
										6BK4B
250	-5V	250	3.5	35	100000	8500	—	6500	3.5	6BK5
150	56Ω	—	—	18	4600	9300	43	Grid-No. 1 Volts for Cutoff, -11		6BK7A
										6BL4
										6BL7GT
100	-2V	—	—	14	—	5000	20	—	—	6BL8
170	-2V	170	2.8	10	400000	6200	—	—	—	6BN4
150	220Ω	—	—	9	6300	6800	43	—	—	6BN6
For other characteristics, refer to Type 6BN6/6KS6										6BN6
										6BQ6GT
150	220Ω	—	—	9.0	5800	6000	35	Grid-No. 1 Volts for Cutoff, -10		6BQ7
125	-1V	—	—	13.5	7500	—	40	—	—	6BR8
125	-1V	110	3.5	9.5	200000	5000	—	—	—	

RCA Type	Name	Out- line	Terminal Dia- gram	Heater or Filament (F)		Use Values to right give operat- ing conditions and charac- teristics for indicated typical use
				Volts	Amperes	
				6BS3	Half-Wave Rectifier	
6BS8	Medium-Mu Twin Triode	6B	9AJ	6.3	0.4	Each Unit as Class A Amplifier
6BV8	Twin Diode—Medium-Mu Triode	6B	9FJ	6.3	0.6	Triode Unit as Class A Amplifier
						With Capacitive Input Filter
6BW4	Full-Wave Rectifier	6E	9DJ	6.3	0.9	With Inductive Input Filter
6BW8	Twin Diode— Sharp-Cutoff Pentode	6B	9HK	6.3	0.45	Pentode Unit as Class A Amplifier
6BX7GT	Medium-Mu Twin Triode	13D	8BD	6.3	1.5	Vertical Deflection Oscillator
						Vertical Deflection Amplifier
6BY5GA	Full-Wave Rectifier	18B	6CN	6.3	1.6	Television Damper Service
6BY11	Beam Power Tube— Sharp-Cutoff Pentode	6C	12EZ	6.3	1.2	Beam Unit as Class A Amplifier Pentode Unit as Class A Amplifier
6BZ7	Medium-Mu Twin Triode	6B	9AJ	6.3	0.4	Each Unit as Class A Amplifier
6BZ8	Medium-Mu Twin Triode	6B	9AJ	6.3	0.4	Each Unit as Class A Amplifier
6C5 6C5GT	Medium-Mu Triode	2A 14A	6Q 6Q	6.3	0.3	Class A Amplifier
6C6	Sharp-Cutoff Pentode	24A	6F	6.3	0.3	Amplifier Detector
6C7	Twin-Diode—Medium-Mu Triode	24B	7G	6.3	0.3	Triode Unit as Class A Amplifier
6C8G	Medium-Mu Twin-Triode	23	8G	6.3	0.3	Each Unit as Class A Amplifier
6C10	High-Mu Triple Triode	8A	12BQ	6.3	0.6	Each Unit as Class A Amplifier
6CA7	Power Pentode		8ET	6.3	1.5	Class A Amplifier Push-Pull Class AB, Amplifier
6CB5	Beam Power Tube	28A	8GD	6.3	2.5	Horizontal Deflection Amplifier
6CB6	Sharp-Cutoff Pentode	5C	7CM	6.3	0.3	Class A Amplifier
6CD6G	Beam Power Tube	28B	5BT	6.3	2.5	Horizontal Deflection Amplifier
6CE3	Half-Wave Vacuum Rectifier	8G	12GK	6.3	2.5	Television Damper Service
6CE5	Sharp-Cutoff Pentode	5C	7BD	6.3	0.3	Class A Amplifier
6CF6	Sharp-Cutoff Pentode	5C	7CM	6.3	0.3	Class A Amplifier
6CG3/ 6CD3	Half-Wave Rectifier	8F	12FX	6.3	1.8	Television Damper Service
6CG8	Medium-Mu Triode—Sharp-Cutoff Pentode	6B	9GF	6.3 6.3	0.45 0.45	Triode Unit as Class A Amplifier Pentode Unit as Class A Amplifier
6CH8	Medium-Mu Triode—Sharp-Cutoff Pentode	6B	9FT	6.3	0.45	Triode Unit as Class A Amplifier Pentode Unit as Class A Amplifier
6CK3	Half-Wave Vacuum Rectifier	30B	9HP	6.3	1.2	Television Damper Service
6CK4	Low-Mu Triode	13F	8JB	6.3	1.25	Vertical Deflection Amplifier
6CL8	Medium-Mu Triode—Sharp-Cutoff Tetrode	6B	9FX	6.3	0.45	Triode Unit as Class A Amplifier Tetrode Unit as Class A Amplifier

Plate Volts	Grid Bias or Cathode Resistor	Screen Grid Volts	Screen Grid Cur- rent mA	Plate Cur- rent mA	AC Plate Resist- ance Ohms	Trans- conduct- ance Micromhos	Amplifi- cation Factor	Power		RCA Type
								Load Ohms	Out- put Watts	
Max. Peak Inverse Plate Volts, 5000				Max. Plate Dissipation, 6 watts				- 5000 + 300	6BS3	
Max. Peak Plate mA, 1100				Max. Peak Heater-Cathode Volts:						
Max. DC Plate mA, 200										
150	220Ω	—	—	10	5000	7200	36	—	6BS8	
200	330Ω	—	—	11	5900	5600	33	—	6BV8	
Max. AC Volts per Plate (RMS), 325								Max. DC Output mA, 62.5		
Max. Peak Inverse Volts, 1275								Max. Peak Plate mA, per Plate, 350		
								Total Effect. Supply Imped. per Plate, 82 ohms		
								Min. Value of Input Choke, 10 henries		
250	68Ω	110	3.5	10	250000	5200	—	—	6BW8	
Max. DC Plate Volts, 500								Max. DC Cathode mA, 180		
Max. Plate Dissipation: 10 watts either plate; 12 watts both plates										
Max. DC Plate Volts, 500								Max. Peak Positive-Pulse Plate Volts, 2000 (Abs.)		
Max. DC Cath. mA, 180								Max. Plate Dissipation: 10 watts either plate; 12 watts both plates		
Max. Peak Inverse Plate Volts, 3000 (Abs.)								Max. Peak Heater-Cathode Volts: { -450 +100		
Max. Peak Plate mA, 525										
Max. DC Plate mA, 175										
170	82Ω	140	3.9	74	33000	4900	—	2500	4	
150	180Ω	100	3.4	2.8	110000	2500	—	(grid no. 1 to plate)		
150	220Ω	—	—	10	5300	6800	36	—	6BZ7	
125	100Ω	—	—	10	5600	8000	45	—	6BZ8	
250	- 8V	—	—	8.0	10000	2000	20	—	6C5 6C5GT	
For other characteristics, refer to Type 6J7										
250	- 9V	—	—	4.5	16000	1250	20	—	6C6	
250	- 4.5V	—	—	3.2	22500	1600	36	—	6C8G	
250	- 2V	—	—	1.2	62500	1600	100	—	6C10	
100	- 1V	—	—	0.5	80000	1250	100	—	6CA7	
265	- 13.5V	250	15	100	15000	11000	—	2000	11	
450	232Ω	450	20	120	—	—	—	6500	40	
Max. DC Plate Volts, 700								Max. Peak Positive-Pulse Plate Volts, 6800 (Abs.)		
Max. DC Cathode mA, 200								Max. Plate Dissipation, 23 Watts		
125	56Ω	125	3.7	13	280000	8000	—	—	6CB6	
Max. DC Plate Volts, 700								Max. Peak Positive-Pulse Plate Volts, 7000		
Max. DC Cathode mA, 200								Max. Plate Dissipation, 20 watts		
For other characteristics, refer to Type 6CE3/6CD3/6DT3										
125	- 1V	125	2.3	11	300000	7600	—	—	6CE3	
125	56Ω	125	3.7	12.5	300000	7800	—	—	6CE5	
125	56Ω	125	3.7	12.5	300000	7800	—	—	6CF6	
Max. Peak Inverse Plate Volts, 5000				Max. DC Plate mA, 350				Max. Peak Heater Cathode Volts: { +300 - 5000		
Max. Peak Plate mA, 2100				Max. Plate Dissipation, 6.5 watts						
100	- 1V	—	—	12	6000	6500	40	—	6CG8	
250	- 1V	125	2.2	9	300000	5500	—	—	6CH8	
200	- 6V	—	—	13	5750	3300	19	—	6CH8	
200	180Ω	150	2.8	9.5	300000	6200	—	—	6CK3	
Max. Peak Inverse Plate Volts, 5200								Max. Peak Heater-Cathode Volts { - 5200** + 300		
Max. Peak Plate mA, 1200								** DC component must not exceed 900 volts		
Max. DC Plate mA, 250										
Max. DC Plate Volts, 550								Max. Peak Positive-Pulse Plate Volts, 2000 (Abs.)		
Max. Peak Cathode mA, 350								Max. Plate Dissipation, 12 watts		
125	- 1V	—	—	14	5000	8000	40	—	6CL8	
125	- 1V	125	4	12	120000	6000	—	—	6CL8	

RCA Type	Name	Out- line	Terminal Dia- gram	Heater or Filament (F)		Use Values to right give operat- ing conditions and character- istics for indicated typical use
				Volts	Amperes	
6CM6	Beam Power Tube	6E	9CK	6.3	0.45	Class A Amplifier
6CM8	High-Mu Triode—Sharp-Cutoff Pentode	6B	9FZ	6.3	0.45	Triode Unit as Class A Amplifier Pentode Unit as Class A Amplifier
6CQ4	Half-Wave Rectifier	13G	4CG	6.3	1.6	Television Damper Service
6CR6	Diode-Remote-Cutoff Pentode	5C	7EA	6.3	0.3	Pentode Unit as Class A Amplifier
6CT3	Half-Wave Rectifier	6H	9RX	6.3	1.2	Television Damper Service
6CU8	Medium-Mu Triode—Sharp-Cutoff Pentode	6B	9GM	6.3	0.45	Triode Unit as Class A Amplifier Pentode Unit as Class A Amplifier
6CW5	Power Pentode	6G	9CV	6.3	0.76	Vertical-Deflection Amplifier
6D4 ♦	Gas Triode	5C	5AY	6.3	0.25	Thyratron
6D6	Remote-Cutoff Pentode	24A	6F	6.3	0.3	Amplifier Mixer
6D7	Sharp-Cutoff Pentode	24A	7H	6.3	0.3	Amplifier Detector
6D8G	Pentagrid Converter	23	8A	6.3	0.15	Converter
6D10	High-Mu Triple Triode	8A	12BQ	6.3	0.45	Each Unit as Class A Amplifier
6DA4	Half-Wave Rectifier	13D	4CG	6.3	1.2	Television Damper Service
6DB5	Beam Power Tube	6F	9GR	6.3	1.2	Class A Amplifier
6DC8	Twin Diode—Remote-Cutoff Pentode	6E	9HE	6.3	0.3	Class A Amplifier
6DC8/ EBF89	Twin Diode—Semiremote Cutoff Pentode	6E	9HE	6.3	0.3	Pentode Unit as Class A Amplifier
6DE4	Half-Wave Vacuum Rectifier	13G	4CG	6.3	1.6	Television Damper Service
6DL4/ EC88	High-Mu Triode	6M	9NY	6.3	0.165	Class A Amplifier
6DL5 6DL5/ EL95	Power Pentode	5E	7DQ	6.3	0.2	Class A Amplifier
6DM4 6DM4A	Half-Wave Rectifier	13G	4CG	6.3	1.2	Damper Service
6DN6	Beam Power Tube	21B	5BT	6.3	2.5	Horizontal Deflection Amplifier
6DQ4	Half-Wave Rectifier	13F	4CG	6.3	1.2	Damper Service
6DQ6A 6DQ6B	Beam Power Tube	20	6AM	6.3	1.2	Horizontal Deflection Amplifier
6DT6	Sharp-Cutoff Pentode	5C	7EN	6.3	0.3	Class A Amplifier
6DW4	Half-Wave Rectifier	11D	9HP	6.3	1.2	Television Damper Service
6DW4A	Half-Wave Rectifier	11D	9HP	6.3	1.2	Television Damper Service
6DW5	Beam Power Tube	6G	9CK	6.3	1.2	Vertical Deflection Amplifier
6DX8	High-Mu Triode—Sharp-Cutoff Pentode	6E	9HX	6.3	0.72	Triode Unit as Class A Amplifier Pentode Unit as Class A Amplifier

♦ Industrial type

Plate Volts	Grid Bias or Cathode Resistor	Screen Grid Volts	Screen Grid Cur- rent mA	Plate Cur- rent mA	AC Plate Resist- ance Ohms	Trans- conduc- tance Micromhos	Amplifi- cation Factor	Power		RCA Type
								Load Ohms	Out- put Watts	
250	-12.5V	—	—	49.5	1960	5000	9.8	(Triode Connected)		6CM6
250	-12.5V	250	4.5	45	50000	4100	—	5000	8	
250	-2V	—	—	1.8	50000	2000	100	—	—	6CM8
250	180Ω	150	2.8	9.5	600000	6200	—	—	—	
Max. Peak Inverse Plate Volts, 5500		5500		Max. DC Plate mA, 190		Max. Peak Heater		{ +300 -5500		6CQ4
Max. Peak Plate mA, 1200		1200		Max. Plate Dissipation, 6.5 watts		Cathode Volts:				
250	-2V	100	2.6	9.6	800000	2200	—	—	—	6CR6
Max. Peak Inverse Plate Volts, 5000		5000		Max. Plate Dissipation, 6.5 Watts		Max. Peak Heater-Cathode Volts:		{ -5000 +3000		6CT3
Max. Peak Plate mA, 1200		1200		Max. Average Plate mA, 250						
125	-1	—	—	17	4100	5800	24	—	—	6CU8
125	56Ω	125	3.8	12	170000	7800	—	—	—	
Max. DC Plate Volts, 275		275		Max. Peak Positive-Pulse Plate Volts, 2200		Max. Plate Dissipation, 12 watts				6CW5
Max. DC Cathode mA, 110		110								
450	Tube Voltage drop at 25 mA = 16 Volts			25	Peak Anode Current = 100 mA					6D4*
For other characteristics, refer to Type 6U7G										6D6
For other characteristics, refer to Type 6J7										6D7
250	-3V	100	2.7	3.5	360000	Anode-Grid (2): 250 max. volts, 4 mA Oscillator-Grid (1) Resistor. Conversion Transcond., 550 micromhos.				6D8G
125	-1V	—	—	4.2	13600	4200	57	—	—	6D10
Max. Peak Inverse Plate Volts, 4400		4400		Max. DC Plate mA, 155		Max. Peak Heater		{ +300 -4400		6DA4
Max. Peak Plate mA, 900		900		Max. Plate Dissipation, 5.5 watts		Cathode Volts:				
200	180Ω	125	2.2	46	28000	8000	—	4000	3.8	6DB5
250	-2V	100	2.7	9	1 M	3800	—	—	—	6DC8
200	-1.5V	100	3.3	11	600000	4500	—	—	—	6DC8/ EBF89
For other characteristics, refer to Type 6DE4/6CQ4										6DE4
160	100Ω	—	—	12.5	—	13500	65	—	—	6DL4/ EC88
200	230Ω	200	4.2	23	—	—	—	8000	2.3	6DL5/ EL95
250	320Ω	250	4.5	24	—	—	—	10000	3	
Max. Peak Inverse Plate Volts, 5000		5000		Max. Peak Plate mA, 1100		Max. DC Plate mA, 175				6DM4 6DM4A
Max. Peak Heater-Cathode Volts, -5000 (DC Component Not to Exceed 900 Volts)		-5000		Max. DC Component Not to Exceed 100 Volts)						
Max. DC Plate Volts, 700		700		Max. Peak Positive-Pulse Plate Volts, 6600 (Abs.)		Max. Plate Dissipation, 15 watts				6DN6
Max. DC Cathode mA, 200		200								
Max. Peak Inverse Volts, 5500		5500		Max. DC Plate mA, 175		Max. Plate Dissipation, 6 watts				6DQ4
Max. Peak Plate mA, 1000		1000								
Max. DC Plate Volts, 770		770		Max. Peak Positive-Pulse Plate Volts, 6000 (Abs.)		Max. Plate Dissipation, 18 watts				6DQ6A 6DQ6B
Max. DC Cathode mA, 155 (6DQ6A)		155								
Max. DC Cathode mA, 175 (6DQ6B)		175								
150	560Ω	100	2.1	1.1	150000	515	—	—	—	6DT6
Max. Peak Inverse Plate Volts, 5000		5000		Max. Plate Dissipation, 8.5		Max. Peak Heater-Cathode Volts:		{ -5000 +300		6DW4
Max. Peak Plate mA, 1300		1300		Max. DC Plate mA, 250						
Max. DC Plate mA, 250		250								
Max. Peak Inverse Plate Volts, 5500		5500		Max. Plate Dissipation, 8.5 Watts		Max. Peak Heater-Cathode Volts:		{ -5500 +3000		6DW4A
Max. Peak Plate mA, 1300		1300		Max. Average Plate mA, 250						
Max. DC Plate Volts, 330		330		Max. Peak Positive-Pulse Plate Volts, 2200		Max. Plate Dissipation, 11 watts				6DW5
Max. DC Cathode mA, 65		65								
200	-1.7V	—	—	3	—	4000	65	—	—	6DX8
170	-2.1V	170	3	18	100000	11000	—	—	—	
200	-2.9V	200	3	18	130000	10400	—	—	—	
220	-3.4V	220	3	18	150000	10000	—	—	—	

RCA Type	Name	Out-line	Terminal Diagram	Heater or Filament (F)		Use Values to right give operating conditions and characteristics for indicated typical use
				Volts	Amperes	
6DZ7	Twin Power Pentode	19B	8JP	6.3	1.52	Class A Amplifier Both Units as Push-Pull Class AB ₂ Amplifier
6E6	Twin Power Amplifier	26	7B	6.3	0.6	Push-Pull Class A Amplifier
6E7	Remote-Cutoff Pentode	24A	7H	6.3	0.3	Amplifier
6EA4	High-Mu Triode	16D	12FA	6.3	0.2	Shunt Voltage Regulator
6EA5	Sharp-Cutoff Tetrode	5C	7EW	6.3	0.2	Class A Amplifier
6EA7	Dual Triode	13B	8BD	6.3	1.05	Vertical Deflection Oscillator Vertical Deflection Amplifier
6EC4A/ EY500	Half-Wave Vacuum Rectifier	35C	6EC4	6.3	2.1	Television Damper Service
6EH4	Beam Triode	16E	12FA	6.3	0.2	Shunt Regulator
6EH7	Semiremote-Cutoff Pentode	6C	9AQ	6.3	0.3	Class A Amplifier
6EH8	Medium-Mu Triode—Sharp-Cutoff Pentode	6B	9JG	6.3	0.45	Triode Unit as Class A Amplifier Pentode Unit as Class A Amplifier
*6EJ4A	Beam Triode	16G	12HC	6.3	0.2	Voltage Control
6EJ7	Sharp-Cutoff Pentode	6C	9AQ	6.3	0.3	Class A Amplifier
6EL4 6EL4A	Beam Triode	21D	8MW	6.3	0.2	Shunt Voltage Regulator
6EM7	Dual Triode	13A	8BD	6.3	0.925	Class A Amplifier
6EQ7	Diode—Remote-Cutoff Pentode	6E	9LQ	6.3	0.3	Pentode Unit as Class A Amplifier
6ES5	High-Mu Triode	5C	7FP	6.3	0.2	Class A Amplifier
6ES8	Variable-Mu Twin Triode	6B	9AJ	6.3	0.365	Each Unit as Class A Amplifier Cascode-Type Amplifier
6ET7	Twin Diode—Sharp-Cutoff Pentode	6E	9LT	6.3	0.75	Pentode Unit as Class A Amplifier
6EU8	Medium-Mu Triode—Sharp-Cutoff Pentode	6B	9JF	6.3	0.45	Triode Unit as Class A Amplifier Pentode Unit as Class A Amplifier
6EV7	High-Mu Twin Triode	6E	9LP	6.3	0.6	Relay Control
6EX6	Beam Power Tube	21B	5BT	6.3	2.25	Horizontal Deflection Amplifier
6EY6	Beam Power Tube	13F	7AC	6.3	0.68	Vertical Deflection Amplifier
6EZ5	Beam Power Tube	13F	7AC	6.3	0.8	Vertical Deflection Amplifier
6EZ8	High-Mu Triple Triode	6B	9KA	6.3	0.45	Each Unit as Class A Amplifier
6F4 [♦]	Triode	acorn	7BR	6.3	0.225	AF, RF Amplifier and Oscillator
6F5 6F5GT	High-Mu Triode	3 14A	5M 5M	6.3	0.3	Class A Amplifier
6F6 6F6G 6F6GT	Power Pentode	2B 25 13F	7S 7S 7S	6.3	0.7	Pentode Class A Amplifier Triode □ Class A Amplifier Pentode Push-Pull Class A Amplifier
6F7	Low-Mu Triode—Remote-Cutoff Pentode	24B	7E	6.3	0.3	Triode Unit as Class A Amplifier Pentode Unit as Class A Amplifier
6F8G	Medium-Mu Twin Triode	23	8G	6.3	0.6	Each Unit as Class A Amplifier
6FA7	Diode—Sharp-Cutoff, Twin-Plate Tetrode	6E	9MR	6.3	0.3	Tetrode Unit as Class A Amplifier
6FE5	Beam Power Tube	13G	8KB	6.3	1.2	Class A Amplifier

♦ Industrial type

* See Safety Precautions at end of this section.

Plate	Grid Bias or Cathode Resistor	Screen Grid	Screen Grid Current	Plate Current	AC Plate Resistance	Trans-conductance	Amplification Factor	Power		RCA Type	
								Load	Output		
Volts		Volts	mA	mA	Ohms	Micromhos		Ohms	Watts		
250	- 7.3V	250	5.5	48	38000	11300	—	—	—	6D27	
400	-11V	250	13	100	—	—	—	9000	18		
300	120Ω	250	15	80	—	—	—	9000	12		
250	-27.5V	—	—	—	—	—	—	14000	1.60†	6E6	
For other characteristics, refer to Type 6U7G										6E7	
Max. DC Plate Volts, 27000					Max. Plate Dissipation, 30 watts					6EA4	
Max. Unregulated DC Plate Supply Volts, 60000					Max. DC Plate mA, 1.6						
250	- 1V	140	0.95	10	150000	8000	—	—	—	6EA5	
250	- 3	—	—	2	30000	2200	66	—	—	6EA7	
175	-25	—	—	40	920	6000	5.5	—	—		
Max. Peak Inverse Plate Volts, 5600					Max. Plate Dissipation, 11 watts					6EC4A/ EY500	
Max. Peak Plate mA, 800					Max. Peak Heater-Cathode Volts, -6300						
Max. DC Plate mA, 440											
Max. Plate Volts, 27000			Max. Peak Grid Volts, -440			Max. Plate Dissipation, 30 watts					6EH4
Max. DC Grid Volts, -135			Max. DC Plate mA, 1.6								
200	- 2V	90	4.5	12	500000	12500	—	—	—	6EH7	
125	- 1V	—	—	13.5	—	7500	40	—	—	6EH8	
125	- 1V	125	4	12	170000	6000	—	—	—		
Max. DC Plate Volts, 27000					Max. DC Plate mA, 1.5					6EJ4A	
Typical Unregulated DC Supply Volts, 36000					Max. Plate Dissipation, 40 watts						
200	- 2.5V	200	4.1	10	350000	15000	—	—	—	6EJ7	
For other characteristics, refer to Type 6LJ6										6EL4 6EL4A	
For other characteristics, refer to Type 6EM7/6EA7										6EM7	
100	0	100	3.5	9	250000	3800	(Rg = 2.2 megohms bypassed)			6EQ7	
200	-1	—	—	10	8000	9000	75	—	—	6ES5	
90	- 1.2V	—	—	15	2500	12500	—	—	—	6ES8	
180	—	—	—	15	—	12500	—	—	—		
200	100Ω	150	5.5	25	60000	11500	(Instantaneous plate knee characteristics)			6ET7	
60	0V	150	18	55	—	—					
150	56Ω	—	—	18	5000	8500	40	—	—	6EU8	
125	-1V	125	4	12	80000	6400	—	—	—		
250	0V	—	—	18.5	Grid Volts for Plate μA 100 = -9					6EV7	
150	0V	—	—	10.0	Grid Volts for Plate μA 100 = -5						
175	-30V	175	3.3	67	8500	7700	—	—	—	6EX6	
250	-17.5V	250	3	44	60000	4400	—	—	—	6EY6	
250	-20V	250	3.5	43	50000	4100	—	—	—	6EZ5	
125	-1	—	—	4.2	13600	4200	57	—	—	6EZ8	
80	150Ω	—	—	13	2900	5800	17	—	—	6F4*	
100	- 1V	—	—	0.4	85000	1150	100	—	—	6F5	
250	- 2V	—	—	0.9	66000	1500	100	—	—	6F5GT	
250	-16.5V	250	6.5	34.0	80000	2500	—	7000	3.2	6F6	
285	-20V	285	7.0	38.0	78000	2550	—	7000	4.8		
250	-20V	—	—	31.0	2600	2600	6.8	4000	0.85	6F6G	
315	-24V	285	12.0□	62.0□	—	—	—	10000	11.0†	6F6GT	
100	- 3V	—	—	3.5	16000	500	8	—	—	6F7	
250	- 3V	100	1.5	6.5	850000	1100	—	—	—		
For other characteristics, refer to Type 6J5										6F8G	
100	0	100	3	2.2	130000	1900(With 2.2 megohm No.1 grid resistor)				6FA7	
Use either plate with unused plate grounded											
145	-16V	145	18	100	8000	9500	—	1000	5.6	6FE5	

† For two tubes at stated plate-to-plate load.

□ For two tubes.

RCA Type	Name	Out- line	Terminal Dia- gram	Heater or Filament (F)		Use Values to right give operat- ing conditions and character- istics for indicated typical use
				Volts	Amperes	
6FG6/ EM84	Refer to type EM84/6FG6					
6FJ7	Medium-Mu Dual Triode	8B	12BM	6.3	0.9	Unit No. 1 as Class A Amplifier Unit No. 2 as Class A Amplifier
6FM8	Twin Diode— High-Mu Triode	6B	9KR	6.3	0.45	Triode Unit as Class A Amplifier
6FQ5A	High-Mu Triode	5C	7FP	6.3	0.18	Class A Amplifier
6FQ7	Medium-Mu Twin Triode	6E	9LP	6.3	0.6	Each Unit as Class A Amplifier
6FV6	Sharp-Cutoff Tetrode	5C	7FQ	6.3	0.2	Class A Amplifier
6FV8	Medium-Mu Triode—Sharp-Cutoff Pentode	6B	9FA	6.3	0.45	Triode Unit as Class A Amplifier Pentode Unit as Class A Amplifier
6FV8A	Medium-Mu Triode Sharp-Cutoff Pentode	6B	9FA	6.3	0.45	Triode Unit as Class A Amplifier Pentode Unit as Class A Amplifier
6FW5	Beam Power Tube	19B	6CK	6.3	1.2	Horizontal Deflection Amplifier
6FW8	Medium-Mu Twin Triode	6B	9AJ	6.3	0.4	Each Unit as Class A Amplifier
6FY5/ EC97	High-Mu Triode	5C	7FP	6.3	0.2	Class A Amplifier
6GG6	Power Pentode	22	7S	6.3	0.15	Pentode Class A Amplifier
6G11	Beam Power Tube—Sharp-Cutoff Pentode	8B	12BU	6.3	1.2	Beam Power Unit as Class A Amplifier Pentode Unit as Class A Amplifier
6GB5	Beam Power Tube	10E	9NH	6.3	1.38	Horizontal Deflection Amplifier
6GF5	Beam Power Tube	8D	12BJ	6.3	1.2	Horizontal Deflection Amplifier
6GF7	Dual Triode	11A	9QD	6.3	0.985	Vertical Deflection Oscillator Vertical Deflection Amplifier
6GH8	Medium-Mu Triode—Sharp-Cutoff Pentode	6B	9AE	6.3	0.45	Triode Unit as Horiz. Defl. Osc. Pentode Unit as Horiz. Defl. Osc.
6GJ5	Novar Beam Power Tube	18A	9QK	6.3	1.2	Horizontal Deflection Amplifier
6GJ7	Medium-Mu Triode— Sharp-Cutoff Pentode	6J	9QA	6.3	0.41	Triode Unit as Class A Amplifier Pentode Unit as Class A Amplifier
6GJ8	Medium-Mu Triode—Sharp-Cutoff Pentode	6B	9AE	6.3	0.6	Triode Unit as Class A Amplifier Pentode Unit as Class A Amplifier
6GL7	Dual-Triode	13B	8BD	6.3	1.05	Unit 1 as Class A Amplifier Unit 2 as Class A Amplifier
6GM5	Power Pentode	10D	9MQ	6.3	0.8	Class A Amplifier
6GQ7	Triple Diode	6B	9QM	6.3	0.45	Each Unit as Half-Wave Rectifier
6GT5	Beam Power Tube	17B	9NZ	6.3	1.2	Horizontal Deflection Amplifier
6GU5	Beam Hexode	5C	7GA	6.3	0.22	Class A Amplifier
6GV8	High-Mu Triode— Power Pentode	6G	9LY	6.3	0.9	Triode Unit as Class A Amplifier Pentode Unit as Class A Amplifier
6GW6	Beam Power Tube	20A	6AM	6.3	1.2	Horizontal Deflection Amplifier
6GX6	Sharp-Cutoff Pentode	5C	7EN	6.3	0.45	Class A Amplifier

Plate Volts	Grid Bias or Cathode Resistor	Screen Grid Volts	Screen Grid Cur- rent mA	Plate Cur- rent mA	AC Plate Resist- ance Ohms	Trans- conduct- ance Micromhos	Amplifi- cation Factor	Power		RCA Type	
								Load Ohms	Out- put Watts		
										6FG6/ EM84	
250	-8	—	—	8	8000	2500	22.5	—	—	6FJ7	
250	-9.5	—	—	41	2000	7700	15.4	—	—		
250	-3	—	—	1	58000	1200	70	—	—	6FM8	
135	-1.2	—	—	8.9	6300	12000	74	—	—	6FQ5A	
250	-8V	—	—	9	7700	2600	20	—	—	6FQ7	
125	-1	80	1.5	10	100000	8000	—	—	—	6FV6	
125	-1V	—	—	14	5000	8000	40	—	—		
125	-1V	125	4	12	200000	6500	—	—	—	6FV8	
125	-1	—	—	12	5600	8000	45	—	—	6FV8A	
125	-1	125	4	12	20000	6500	—	—	—		
	Max. DC Plate Volts, 770 Max. DC Cathode mA, 610				Max. Peak Positive-Pulse Plate Volts, 6500 Max. Plate Dissipation, 18 watts						6FW5
100	1.2V	—	—	15	2500	13000	33	—	—	6FW8	
135	-1V	—	—	11	—	13000	70	—	—	6FY5/ EC97	
180	-9V	180	2.5	15.0	175000	2300	—	10000	1.1	6GG6	
120	-8V	110	4	49	10000	7500	—	2500	2.3	6G11	
150	150Ω	150	3.5	15	20000	9500	—	—	—		
	Max. DC Plate Volts, 275 Max. DC Cathode mA, 275				Max. Peak Positive-Pulse Plate Volts, 7700 Max. Plate Dissipation, 17 watts						6GB5
	Max. DC Plate Volts, 770 Max. DC Cathode mA, 160				Max. Peak Positive-Pulse Plate Volts, 5000 Max. Plate Dissipation, 9 watts						6GF5
	Max. DC Plate Volts, 330 Max. DC Cathode mA, 22				Max. Plate Dissipation, 1.5 watts						6GF7
	Max. DC Plate Volts, 330 Max. DC Cathode mA, 50				Max. Peak Positive-Pulse, Plate Volts, 1500 (Abs.) Max. Plate Dissipation, 11 watts						
	Max. DC Plate Volts, 330				Max. Plate Dissipation, 2.5 watts						6GH8
	Max. DC Plate Volts, 350 Max. Peak Neg.-Pulse Grid Volts, 175				Max. Peak Cathode mA, 300 Max. DC Cathode mA, 20			Max. Plate Dissipation, 2.5 watts			
250	-22.5V	150	2.1	70	15000	7100	—	—	—	6GJ5	
100	-3V	—	—	15	—	9000	20	—	—	6GJ7	
170	-1.2V	120	3	10	350000	11000	Ampl. Factor, 55 (Grid No. 2 to Grid No. 1)		—		
125	-1V	—	—	13.5	5000	8500	40	—	—	6GJ8	
125	-1V	125	4.5	12	150000	7500	—	—	—		
250	-3V	—	—	2	30000	2200	66	—	—	6GL7	
175	-25V	—	—	46	780	6400	5	—	—		
300	-10V	300	8	60	29000	10200	—	3000	11	6GM5	
	Max. Peak Inverse Volts, 330 Max. RMS Plate Volts, 117 Max. Peak Plate mA, 54				Max. DC Average mA, 9 Min. Total Effective Plate Supply Impedance, 300 ohms						6GQ7
	Max. DC Plate Volts, 770 Max. DC Cathode mA, 175 Max. Plate Dissipation, 17.5 watts				Max. Peak Neg.-Pulse Grid-No. 1 Volts, -330 Max. Grid-No. 2 Volts, 220 Max. Peak Positive-Pulse Plate Volts, 6500						6GT5
135	-0.4V	—	—	9	67000	15000	—	—	—	6GU5	
100	-0.8V	—	—	5	7600	6500	50	—	—	6GV8	
170	-15	170	2.7	41	25000	7500	—	—	—		
250	-22.5V	150	2.1	70	15000	7100	—	—	—	6GW6	
150	180Ω	100	3	3.7	140000	3700	(Grid No. 1 to plate)			6GX6	

RCA Type	Name	Out-line	Terminal Diagram	Heater or Filament (F)		Use Values to right give operating conditions and characteristics for indicated typical use
				Volts	Amperes	
6GY8	High-Mu Triple Triode	6B	9MB	6.3	0.45	Unit No. 1 as Class A Amplifier Units No. 2 and No. 3 as Class A Amplifier
6GZ5	Power Pentode	5C	7CV	6.3	0.38	Class A Amplifier
6HG6 6HG6T	Twin Diode	29B 13D	7Q 7Q	6.3	0.3	Voltage Doubler Half-Wave Rectifier
6HB6 6HB6/ 6HAG	Power Pentode	6G	9NW	6.3	0.76	Vertical Deflection Amplifier
6HD7	Medium-Mu Triode— Sharp-Cutoff Pentode	6B	9QA	6.3	0.45	Triode Unit as Class A Amplifier Pentode Unit as Class A Amplifier
6HG5	Beam Power Tube	5D	7BZ	6.3	0.45	Class A Amplifier
6HG8	Medium-Mu Triode— Sharp-Cutoff Pentode	6B	9MP	6.3	0.34	Triode Unit as Class A Amplifier Pentode Unit as Class A Amplifier
6HJ5	Beam Power Tube	15C	12FL	6.3	2.25	Horizontal Deflection Amplifier
6HJ8	Diode—Sharp-Cutoff Pentode	6B	9CY	6.3	0.45	Pentode Unit as Class A Amplifier
6HK5	High-Mu Triode	5C	7GM	6.3	0.19	Class A Amplifier
6HM6	Sharp-Cutoff Pentode	6B	9PM	6.3	0.3	Class A Amplifier
6HR5	Beam Power Tube	5D	7BZ	6.3	0.45	Vertical-Deflection Amplifier
6HR6	Semiremote-Cutoff Pentode	5C	7BK	6.3	0.45	Class A Amplifier
6HU6/ EM87	Electron-Ray Tube	6N	9GA	6.3	0.3	Tuning Indicator
6HU8/ ELL80	Twin Pentode	6G	9NJ	6.3	0.55	Power Amplifier
6HV5	Beam Triode	15E	12GY	6.3	1.8	Class A Amplifier
6HZ5/ 6JD5	Beam Triode	15F	12GY	6.3	2.4	High Voltage Pulse Regulator
6HZ8	High-Mu Triode— Sharp-Cutoff Pentode	10G	9DX	6.3	1.125	Triode Unit as Class A Amplifier Pentode Unit as Class A Amplifier
6J4* 6J4WA*	Triode	5C	7BQ	6.3	0.4	UHF Amplifier
6J5 6J5GT	Medium-Mu Triode	2A 13D	6Q 6Q	6.3	0.3	Class A Amplifier
6J6 6J6WA* 6J6WB*	Medium-Mu Twin Triode	5C	7BF	6.3 6.3	0.45 0.45	Each Unit as Class A Amplifier Push-Pull Class C Amplifier
6J7 6J7G 6J7GT	Sharp-Cutoff Pentode	3 23 14A	7R 7R 7R	6.3	0.3	Pentode Class A RF Amplifier
6J8G	Triode-Heptode Converter	23	8H	6.3	0.3	Triode Unit as Oscillator Heptode Unit as Mixer
6J9	High-Mu Triple Triode	6B	10G	6.3	0.45	Each Unit as Class A Amplifier
6J10	Pentode-Beam Power Tube	8B	12BT	6.3	0.95	Pentode Units as Class A Amplifier
6J11	Sharp-Cutoff Twin Pentode	8A	12BW	6.3	0.8	Each Unit as Class A Amplifier

Plate Volts	Grid Bias or Cathode Resistor	Screen Grid Volts	Screen Grid Cur- rent mA	Plate Cur- rent mA	AC Plate Resist- ance Ohms	Trans- conduc- tance Micromhos	Amplifi- cation Factor	Power		RCA Type	
								Load Ohms	Out- put Watts		
125 125	220Ω —1V	— —	— —	4.5 4.5	14000 14000	4500 4500	63 63	— —	— —	6GY8	
250 250	270Ω 270Ω (bypassed)	250 250	2.7 2.7	16 16	— 150000	— 8400	— —	15000 15000	1.8 1.1	6GZ5	
Max. AC Supply Volts per Plate (RMS), 117 Min. Total Effect. Plate-Supply Imped. per Plate:								Max. DC Output mA, 8. min. 30 ohms; full wave, 15 ohms		6HG	
Max. AC Plate Volts (RMS), 150 Max. DC Output mA, 8 per Plate								Min. Total Effective Plate-Supply Impedance: up to 117 volts, 15 ohms; at 150 volts, 40 ohms		6HG6T	
250 250	33Ω 100Ω	125 250	4.2 6.2	40 40	28000 24000	24000 20000	— 33	— —	— —	6HB6 6HB6/ 6HA6	
100 125	—0V —1V	— 125	— 3.5	14 12	4880 —	8200 7000	40 —	— —	— —	6HD7	
250 180	—12.5V —8.5V	250 180	4.5 3	45 29	52000 58000	4100 3700	— —	5000 5500	4.5 2	6HG5	
100	—3V	—	—	14	—	5500	17	—	—	6HG8	
170	—1.2V	150	3.3	10	350000	12000	—	—	—	6HJ5	
135	—22	135	5.5	80	5000	10000	4.2	—	—	6HJ8	
125	56Ω	125	3.6	11.5	200000	9300	—	—	—	6HK5	
135	—1V	—	—	12.5	5000	15000	75	—	—	6HM6	
125	56Ω	125	3.2	13	156000	15000	—	—	—	6HR5	
260 50	—19V 0V	270 250	2.3 25	30 105	— —	3600 —	— —	— —	— —	6HR6	
200	68Ω	115	4.3	13.2	500000	8500	—	—	—	6HU6/ EM87	
Triode Plate and Fluorescent-Target Volts = 250 Triode Grid-Supply Volts = -10 to +15								Shadow Section = 0 to 0.83 inch		6HU8/ ELL80	
250	160Ω	250	4.5	24	80000	6000	—	10000	3	6HV5	
For other characteristics, refer to Type 6HS5											
Max. Pulse Plate Volts, 5500 Max. Peak Plate mA, 325				Max. Plate Dissipation, 35 watts Max. Peak Heater-Cathode Volts, +200, -450							6HZ8
200	—	—	—	3.5	—	4000	70	—	—	6J4♦ 6J4WA♦	
250	100	170	6	29	140000	12600	—	—	—	6J5 6J5GT	
150	100Ω	—	—	15	4500	12000	55	—	—	6J6	
90 250	0V —8V	— —	— —	10 9	6700 7700	3000 2600	20 20	— —	— —	6J7 6J7G 6J7GT	
100	50Ω (For both units)			8.5	7100	5300	38	—	—	6J8	
150	—10V	—	—	30	Grid Current, 16 mA Driving Power, 0.35 watt		—	—	3.5	6J6WA♦ 6J6WB♦	
100 250	—3V —3V	100 100	0.5 0.5	2.0 2.0	1 M 1 M	1185 1225	— —	— —	— —	6J9	
100 250	Triode-Grid Resistor, 50000 ohms			4 5	— —	— —	— —	— —	— —	6J10	
250	—3V	100	2.8	1.4	1.5 M	Conversion Transcond., 290 micromhos		—	—	6J11	
125	—1V	—	—	6	11000	5200	57	—	—	6J9	
250	—8V	250	2.5	35	100000	6500	—	5000	4.2	6J10	
125	56Ω	125	3.8	11	200000	13000	—	—	—	6J11	

RCA Type	Name	Out- line	Terminal Dia- gram	Heater or Filament (F)		Use Values to right give operat- ing conditions and character- istics for indicated typical use
				Volts	Amperes	
6JA5	Beam Power Tube	15D	12EY	6.3	1.0	Vertical Deflection Amplifier
6JB6	Beam Power Tube	18A	9QL	6.3	1.2	Horizontal Deflection Amplifier
6JC6	Sharp-Cutoff Pentode	6B	9PM	6.3	0.3	Class A Amplifier
6JE6	Beam Power Tube	32D	9QL	6.3	2.5	Horizontal Deflection Amplifier
6JE6A	Beam Power Tube	32B	9QL	6.3	2.5	Horizontal Deflection Amplifier
6JE8	High-Mu Triode Sharp-Cutoff Pentode	6E	9DX	6.3	0.78	Triode Unit as Class A Amplifier Pentode Unit as Class A Amplifier
6JG6	Beam Power Tube	17B	9QU	6.3	1.6	Horizontal Deflection Amplifier
6JK6	Sharp-Cutoff Pentode	5C	7CM	6.3	0.35	Class A Amplifier
6JK8	Dual Triode	6B	9AJ	6.3	0.4	Unit No. 1 as Oscillator Unit No. 2 as RF Amplifier
6JM6	Beam Power Tube	39A	12FJ	6.3	1.2	Horizontal Deflection Amplifier
6JS6	Beam Power Tube	16B	12FY	6.3	2.25	Horizontal Deflection Amplifier
6JSGA	Beam Power Tube	16B	12FY	6.3	2.25	Horizontal Deflection Amplifier
6JT6	Beam Power Tube	17C	9QU	6.3	1.2	Horizontal Deflection Amplifier
6JU8	Quadruple Diode	6E	9PQ	6.3	0.6	Phase Detector
6JZ6	Beam Power Tube	39A	12GD	6.3	1.5	Horizontal Deflection Amplifier
6K5GT	High-Mu Triode	14A	5U	6.3	0.3	Class A Amplifier
6K7 6K7G 6K7GT	Remote-Cutoff Pentode	3 23 14A	7R 7R 7R	6.3	0.3	Class A Amplifier
6K8 6K8G 6K8GT	Triode-Hexode Converter	3 23 —	8K 8K 8K	6.3	0.3	Triode Unit as Oscillator Hexode Unit as Mixer
6K11 6K11/ 6Q11	Twin High-Mu Triode— Medium-Mu Triode	8A	12BY	6.3	0.6	Twin Unit as Class A Amplifier Class A Amplifier
6KL8	Diode—Sharp-Cutoff Pentode	6E	9LQ	6.3	0.3	Pentode Unit as Class A Amplifier
6KN8/ 6RHH8	Medium-Mu Twin Triode	6B	9AJ	6.3	0.4	Each Triode as Class A Amplifier
6KU8	Twin Diode— Sharp-Cutoff Pentode	10A	9LT	6.3	0.725	Pentode Unit as Class A Amplifier
6KV6	Beam Power Tube	31D	9QU	6.3	1.6	High-Voltage-Pulse Shunt Regulator
6KY6	Sharp-Cutoff Pentode	6E	9GK	6.3	0.52	Class A Amplifier
6KY8	High-Mu Triode Beam Power Tube	11C	9QT	6.3	1.1	Triode Unit as Oscillator Beam Power Unit as Amplifier
6L5G	Medium-Mu Triode	22	6Q	6.3	0.15	Class A Amplifier Single-Tube Class A Amplifier
6L6G 6L6GB	Beam Power Tube	27B 19D	7AC 7AC	6.3	0.9	Push-Pull Class A Amplifier Push-Pull Class AB ₁ Amplifier
6L7 6L7G	Pentagrid Mixer	3 23	7T 7T	6.3	0.3	Mixer Service

Plate Volts	Grid Bias or Cathode Resistor	Screen Grid Volts	Screen Grid Current mA	Plate Current mA	AC Plate Resistance Ohms	Trans- conductance Micromhos	Amplifi- cation Factor	Power		RCA Type	
								Load Ohms	Out- put Watts		
135 45	-10V 0V	125 125	4.2 20	95 210	42000	10300 Instantaneous Plate Knee characteristic	—	—	—	6JA5	
Max. DC Plate Volts, 770 Max. Peak Cathode mA, 550 Max. Plate Dissipation, 17.5 watts						Max. Peak Neg.-Pulse Grid-No. 1 Volts, — 330 Max. Grid-No. 2 Volts, 220 Max. Peak Positive-Pulse Plate Volts, 6500				6JB6	
125	56Ω	125	3.2	13	0.18	15000	—	—	—	6JC6	
For other characteristics, refer to Type 6JE6A										6JE6	
175	-25	125	2.8	130	5800	9600	3	—	—	6JE6A	
200	-2V	—	—	4.5	—	4200	70	—	—	—	
250	82Ω	170	4	22	140000	12000	—	—	—	6JE8	
60	0V	170	12	48	Instantaneous Plate Knee characteristic					—	
For other characteristics, refer to Type 6JG6A										6JG6	
125	68Ω	125	3.9	11.5	150000	18000	—	—	—	6JK6	
100	-1V	—	—	5.3	8000	6800	55	—	—	—	
135	-1.2V	—	—	10	5400	13000	70	—	—	6JK8	
For other ratings, refer to Type 6JM6										6JM6	
175	-25V	125	4.5	125	5600	11300	3	—	—	6JS6	
175	-25	125	4.5	125	5600	11300	3	—	—	6JS6A	
For other ratings, refer to Type 6JT6										6JT6	
Max. Peak Inverse Plate Volts, 300 Max. Peak Plate mA, 54					Max. DC Output mA, 9 Max. Peak Heater-Cathode Volts, ± 300					—	6JU8
130	-20V	130	1.8	46	9900	9000	—	—	—	6JZ6	
50	0V	130	29	450	Instantaneous Plate Knee characteristic					—	
250	-3V	—	—	1.1	50000	1400	70	—	—	6K5GT	
250	-3V	125	2.6	10.5	600000	1650	—	—	—	6K7 6K7G 6K7GT	
100	Grid Res., 50000 ohms			3.8	Triode-Grid & Hexode-Grid Current, 0.15 mA					—	6K8
100	-3V	100	6.2	2.3	400000	Conversion Transcond., 325 micromhos				—	6K8G
250	-3V	100	6.0	2.5	600000	Conversion Transcond., 350 micromhos				—	6K8GT
250	-2V	—	—	1.2	62500	1600	100	—	—	6K11	
250	-8.5V	—	—	10.5	7700	2200	17	—	—	6K11/ 6Q11	
100	0	100	2.2	5.5	555000	4300	Grid-No. 1 Volts for plate current of 10 μA, 4.2		—	6KL8	
110	-1V	—	—	16	2800	16000	45	—	—	6KN8/ 6RHH8	
For other characteristics, refer to Type 10KU8										6KU8	
For other characteristics, refer to Type 6KV6A										6KV6	
200	-18V	135	5.2	30	40000	30000	—	—	—	6KY6	
Max. DC Plate Volts, 330 Max. DC Cathode mA, 22					Max. Plate Dissipation, 1.5 watts					—	—
Max. DC Plate Volts, 300 Max. DC Cathode mA, 60					Max. Peak Positive-Pulse Plate Volts, 2200 (Abs.) Max. Plate Dissipation, 12 watts					—	6KY8
250	-9V	—	—	8.0	9000	1900	17	—	—	6L5G	
250	-14V	250	5.0	72.0	—	—	—	2500	6.5	—	
250	168Ω	250	5.4	75.0	—	—	—	2500	6.5	—	
270	-17.5V	270	11.0□	134.0□	—	—	—	5000	17.5†	6L6G	
270	124Ω□	270	11.0□	134.0□	—	—	—	5000	18.5†	6L6GB	
360	-22.5V	270	5.0□	88.0□	—	—	—	6600	26.5†	—	
360	248Ω□	270	5.0□	88.0□	—	—	—	9000	24.5†	—	
250	-6V	150	9.2	2.3	Oscillator-Grid (No. 3) Bias, -15 volts Grid-No. 3 Peak Swing, 16 volts minimum Conversion Transcond., 350 micromhos				—	6L7 6L7G	

† For two tubes at stated plate-to-plate load.

□ For two tubes.

RCA Type	Name	Out- line	Terminal Dia- gram	Heater or Filament (F)		Use Values to right give operat- ing conditions and character- istics for indicated typical use
				Volts	Amperes	
6LB8	Medium-Mu Triode Sharp-Cutoff Pentode	10A	9DX	6.3	0.725	Triode Unit as Class A Amplifier
						Pentode Unit as Class A Amplifier
6LH6A	Beam Triode	21D	8ML	6.3	0.2	Shunt Voltage Regulator
6LJ6	Beam Triode	21D	8MQ	6.3	0.2	Shunt Voltage Regulator
6LQ6/ 6JE6B	Beam Power Tube	32C	9QL	6.3	2.5	Horizontal Deflection Amplifier
6LZ6	Beam Power Tube	32C	9QL	6.3	2.3	Horizontal Deflection Amplifier
★6MA6	Beam Triode	21D	8NP	6.3	0.2	Shunt Voltage Regulator
6MK8	Sharp-Cutoff Pentode	6E	9FG	6.3	0.3	Class A Amplifier
6ML8	Medium-Mu Triple Triode	6B	9RQ	6.3	0.675	Class A Amplifier
6N6G	Direct-Coupled Power Triode	25	7AU	6.3	0.8	Class A Amplifier
6N7 6N7GT	Medium-Mu Twin Power Triode	2B 13D	8B 8B	6.3	0.8	Class A Amplifier (as Driver) Class B Amplifier
6P5GT	Medium-Mu Triode	13D	6Q	6.3	0.3	Amplifier Detector
6P7G	Low-Mu Triode—Remote-Cutoff Pentode	23	7U	6.3	0.3	Amplifier and Converter
6Q7 6Q7G 6Q7GT	Twin Diode High-Mu Triode	3 23 14A	7V 7V 7V	6.3	0.3	Triode Unit as Class A Amplifier
6Q11	Twin High-Mu Triode— Medium-Mu Triode	8A	12BY	6.3	0.6	Twin Unit as Class A Amplifier Class A Amplifier
6R7 6R7G 6R7GT	Twin Diode—Medium-Mu Triode	3 23 14A	7V 7V 7V	6.3	0.3	Triode Unit as Class A Amplifier
6RP22	Power Pentode	6E	9BV	6.3	0.65	Class A Amplifier
6S4	Medium-Mu Triode	8E	9AC	6.3 6.3	0.6 0.6	Vertical Deflection Amplifier
6S7 6S7G	Remote-Cutoff Pentode	3 23	7R 7R	6.3	0.15	Class A Amplifier
6S8GT	Triple Diode—High-Mu Triode	14C	8CB	6.3	0.3	Triode Unit as Class A Amplifier
6SA7 6SA7GT	Pentagrid Converter	2A 13D	8R 8AD	6.3	0.3	Converter
6SB7Y	Pentagrid Converter	2A	8R	6.3	0.3	Mixer
6SC7	High-Mu Twin Triode	2A	8S	6.3	0.3	Each Unit as Amplifier
6SF5 6SF5GT	High-Mu Triode	2A 13D	6AB 6AB	6.3	0.3	Class A Amplifier
6SF7	Diode—Remote-Cutoff Pentode	2A	7AZ	6.3	0.3	Pentode Unit as Class A Amplifier
6SG7	Semiremote-Cutoff Pentode	2A	8BK	6.3	0.3	Class A Amplifier
6SH7	Sharp-Cutoff Pentode	2A	8BK	6.3	0.3	Class A Amplifier
6SJ7 6SJ7GT	Sharp-Cutoff Pentode	2A 13D	8N 8N	6.3	0.3	Class A Amplifier
6SK7 6SK7GT	Remote-Cutoff Pentode	2A 13D	8N 8N	6.3	0.3	Class A Amplifier
6SN7GT 6SN7 GTA	Medium-Mu Twin Triode	13D 13D	8BD	6.3 6.3	0.6 0.6	Each Unit as Class A Amplifier Each Unit as Vertical Amplifier

Plate Volts	Grid Bias or Cathode Resistor	Screen Grid Volts	Screen Grid Cur- rent mA	Plate Cur- rent mA	AC Plate Resist- ance Ohms	Trans- conduct- ance Micromhos	Amplifi- cation Factor	Power		RCA Type	
								Lead Ohms	Out- put Watts		
125	68Ω	—	—	13	6000	5000	30	—	—	6LB8	
200	82Ω	100	3.5	17	5000	20000	—	—	—		
50	0V	100	18	55	Instantaneous Plate Knee characteristic						
For other characteristics, refer to Type 6LJ6										6LH6A	
Max. Plate Volts, 27000					Max. Average Plate mA, 1.6					6LJ6	
Max. Unregulated Plate Supply Volts, 60000					Max. Plate Dissipation, 40 Watts						
175	-35	145	2.4	95	7000	7500	2.8	—	—	6LQ6/ 6JE6B	
For other characteristics, refer to Type 31LZ6										6LZ6	
Max. Plate Volts, 30000					Max. Average Plate mA, 1.5					6MA6	
					Max. Plate Dissipation, 40 Watts						
For other characteristics, refer to Type 6MK8A										6MK8	
125	-1V	—	—	11	6400	6700	43	—	—	6ML8	
Output Triode: Plate Volts, 300; Plate mA, 45; Load, 7000 ohms											
Triode: Plate Volts, 300; Grid Volts, 0; Input Plate mA, 8										4.0	
250	-5V	—	—	6.0	11300	3100	35	20000	exceeds	6N7	
300	-6V	—	—	7.0	11000	3200	35	or more	0.4	6N7GT	
300	0V	Power Output for 1 tube at stated plate-to-plate load							8000	10.0	
250	-13.5	—	—	5.0	9500	—	13.8	—	—	6P5GT	
For other characteristics, refer to Type 6F7										6P7G	
100	-1V	—	—	0.8	58000	1200	70	—	—	6Q7	
250	-3V	—	—	1.1	58000	1200	70	—	—	6Q7G	
250	-2V	—	—	1.2	62500	1600	100	—	—	6Q7GT	
150	0V	—	—	22	7000	2500	18	—	—	6Q11	
250	-9V	—	—	9.5	8500	1900	16	—	—	6R7	
										6R7G	
										6R7GT	
250	-3V	150	8.5	22	55000	8500	—	—	—	6RP22	
Max. DC Plate Volts, 550					Max. Peak Positive-Pulse Plate Volts, 2200					6S4	
Max. DC Cathode mA, 30					Max. Plate Dissipation, 8.5 watts						
250	-3V	100	2.0	8.5	1 M	1750	—	—	—	6S7	
										6S7G	
250	-2V	—	—	0.9	91000	1100	100	—	—	6S8GT	
250	Self- Excited	100	8.5	3.5	1.0	Grid-No. 1 Resistor, 20000 ohms. Conversion Transcond., 450 micromhos				6SA7 6SA7GT	
100	-1V	100	10.2	3.6	500000	Grid-No. 1 Resistor, 20000 ohms. Conversion Transcond., 950 micromhos				6SB7Y	
250	-2V	—	—	2.0	53000	1325	70	—	—	6SC7	
250	-2V	—	—	0.9	66000	1500	100	—	—	6SF5	
										6SF5GT	
100	-1V	100	3.4	12.0	200000	1975	—	—	—	6SF7	
250	-1V	100	3.3	12.4	700000	2050	—	—	—		
100	-1V	100	3.2	8.2	250000	4100	—	—	—	6SG7	
250	-2.5V	150	3.4	9.2	1 M	4000	—	—	—		
100	-1V	100	2.1	5.3	350000	4000	—	—	—	6SH7	
250	-1V	150	4.1	10.8	900000	4900	—	—	—		
100	-3V	100	0.9	2.9	700000	1575	—	—	—	6SJ7	
250	-3V	100	0.8	3.0	1 M	1650	—	—	—	6SJ7GT	
100	-1V	100	4.0	13.0	120000	2350	—	—	—	6SK7	
250	-3V	100	2.6	9.2	800000	2000	—	—	—	6SK7GT	
100	0V	—	—	10.0	6700	3000	20	—	—	6SN7GT	
250	-8V	—	—	9.0	7700	2600	20	—	—	6SN7 GTA	
Max. DC Plate Volts, 450					Max. Plate Dissipation: 5 watts either plate; 7.5 watts both plates						
Max. Peak Cathode mA, 70					Max. Peak Positive Pulse Plate Volts, 1500						

RCA Type	Name	Out- line	Terminal Dia- gram	Heater or Filament (F)		Use Values to right give operat- ing conditions and character- istics for indicated typical use
				Volts	Amperes	
6SQ7 6SQ7GT	Twin-Diode—High-Mu Triode	2A 13D	8Q 8Q	6.3	0.3	Triode Unit as Class A Amplifier
6SR7	Twin Diode—Medium-Mu Triode	2A	8Q	6.3	0.3	Triode Unit as Class A Amplifier
6SS7	Remote-Cutoff Pentode	2A	8N	6.3	0.15	Class A Amplifier
6ST7	Twin Diode—Medium-Mu Triode	2A	8Q	6.3	0.15	Triode Unit as Amplifier
6SZ7	Twin Diode—High-Mu Triode	2A	8Q	6.3	0.15	Triode Unit as Class A Amplifier
6T4	Medium-Mu Triode	5D	7DK	6.3	0.225	Oscillator in UHF TV Receivers Class A Amplifier
6T7G	Twin Diode—High-Mu Triode	22	7V	6.3	0.15	Triode Unit as Class A Amplifier
6T8	Triple Diode—High-Mu Triode	6B	9E	6.3 6.3	0.45 0.45	Triode Unit as Class A Amplifier
6T9	High-Mu Triode— Power Pentode	8B	12FM	6.3	0.93	Triode Unit as Class A Amplifier Pentode Unit as Class A Amplifier
6U5	Electron-Ray Tube	13H	6R	6.3	0.3	Visual Indicator
6U7G	Remote-Cutoff Pentode	28J	7R	6.3	0.3	Class A Amplifier
6U8	Medium-Mu Triode—Sharp-Cutoff Pentode	6B	9AE	6.3	0.45	Triode Unit as Class A Amplifier Pentode Unit as Class A Amplifier
6U9/ ECF201	Medium-Mu Triode Sharp-Cutoff Pentode	6B	10K	6.3	0.41	Triode Unit as Class A Amplifier Pentode Unit as Class A Amplifier
6V3A	Half Wave Rectifier	7B	9BD	6.3	1.75	Television Damper Service
6V6GT 6V6GTY	Beam Power Tube	13D	7AC	6.3	0.45	Single-Tube Class A Amplifier Push-Pull Class AB ₁ Amplifier
6V7G	Twin Diode—Low-Mu Triode	23	7V	6.3	0.3	Triode Unit as Amplifier
6W4GT	Half-Wave Rectifier	13D	4CG	6.3	1.2	Television Damper Service
6W7G	Sharp-Cutoff Pentode	23	7R	6.3	0.15	Class A Amplifier
6X4W♦	Full-Wave Rectifier	5D	5BS	6.3	0.6	With Capacitive-Input Filter With Inductive-Input Filter
6X5	Full-Wave Rectifier	2B	6S	6.3	0.6	With Capacitive-Input Filter With Inductive-Input Filter
6X8	Medium-Mu Triode— Sharp-Cutoff Pentode	6B	9AK	6.3	0.45	Triode Unit as Class A Amplifier Pentode Unit as Class A Amplifier
6Y5	Full-Wave Rectifier	22 or 13H	6J	6.3	0.8	With Capacitive-Input Filter
6Y7G	High-Mu Twin Power Triode	22	8B	6.3	0.6	Class B Amplifier
6Y9	Dual Pentode	6L	10L	6.3	0.8	Unit No. 1 as Class A Amplifier Unit No. 2 as Class A Amplifier
6Z4	Refer to type 84/6Z4					
6Z5	Full-Wave Rectifier	22	6K	12.6 6.3	0.8 0.4	With Capacitive-Input Filter
6Z7G	High-Mu Twin Power Triode	22	8B	6.3	0.3	Class B Amplifier
6Z10	Power Pentode Gated-Beam Discriminator	8C	12BT	6.3	0.95	Class A Amplifier
6ZY5G	Full-Wave Rectifier	22	6S	6.3	0.3	With Capacitive-Input Filter

♦ Industrial type

Plate Volts	Grid Bias or Cathode Resistor	Screen Grid Volts	Screen Grid Current mA	Plate Current mA	AC Plate Resistance Ohms	Trans- conductance Micromhos	Amplifi- cation Factor	Power		RCA Type
								Load Ohms	Out- put Watts	
100	— 1V	—	—	0.5	110000	925	100	—	—	6SQ7
250	— 2V	—	—	1.1	85000	1175	100	—	—	6SQ7GT
250	— 9V	—	—	9.5	8500	1900	16	—	—	6SR7
250	— 3V	100	2.0	9.0	1 M	1850	—	—	—	6SS7
For other characteristics, refer to Type 6SR7										6ST7
100	— 1V	—	—	0.8	54000	1300	70	—	—	6SZ7
250	— 3V	—	—	1.0	53000	1200	70	—	—	6SZ7
Max. DC Plate Volts, 200				Max. Grid mA, 8		Max. Plate Dissipation, 3.5 watts				6T4
Max. DC Cathode mA, 30										
80	150Ω	—	—	18	—	7000	13	—	—	
250	— 3V	—	—	1.2	62000	1050	65	—	—	6T7G
300	4580Ω	—	—	Grid Resistor, 0.5 MΩ		Gain per stage, 40				
100	— 1V	—	—	0.8	54000	1300	70	—	—	6T8
250	— 3V	—	—	1.0	58000	1200	70	—	—	6T8
250	— 2V	—	—	1.5	45000	2100	—	—	—	6T9
250	— 8V	250	2.5	35	100000	6500	—	5000	4.2	6T9
Plate & Target Supply, 250 volts. Triode Plate Resistor, 1.0 MΩ Target Current, 4.0 mA										6U5
Grid Bias, —22 volts; Shadow Angle, 0°. Bias, 0 volts; Angle, 90°; Plate Current, 0.24 mA										
250	— 3V	100	2.0	8.2	800000	1600	—	—	—	6U7G
125	— 1V	—	—	13.5	—	7500	40	—	—	6U8
125	— 1V	110	3.5	9.5	200000	5000	—	—	—	6U8
100	— 2V	—	—	14	—	5000	17	—	—	6U9/ ECF201
160	— 1.4V	110	5	13	—	12000	—	—	—	6U9/ ECF201
Max. Peak Inverse Plate Volts, 6000 (Abs.)				Max. Average Plate mA, 135						6V3A
Max. Peak Plate mA, 800				Max. Peak Heater-Cathode Volts: { -6750 (Abs.) +300						
250	— 12.5V	250	4.5	45.0	50000	4100	—	5000	4.5	6V6GT
315	— 13V	225	2.2	34.0	80000	3750	—	8500	5.5	6V6GT
250	— 15V	250	5.0	70.0	—	—	—	10000	10.0†	6V6GT
285	— 19V	285	4.0	70.0	—	—	—	8000	14.0†	6V6GT
For other characteristics, refer to Type 85										6V7G
Max. Peak Inverse Plate Volts, 3850				Max. Plate Dissipation, 3.5 watts						6W4GT
Max. Peak Plate mA, 750				Max. Peak Heater-Cathode Volts, —2300, +300						
Max. Average Plate mA, 125										
250	— 3V	100	0.5	2.0	1.5 M	1225	—	—	—	6W7G
For other characteristics, refer to Type 6X4										6X4W*
Max. AC Volts per Plate (RMS), 325				Max. DC Output mA, 70		Min. Total Effect. Supply				6X5
Max. Peak Inverse Volts, 1250				Max. Peak Plate mA, 245		Imped. per Plate, 525 ohms				
Max. AC Volts per Plate (RMS), 400				Max. DC Output mA, 70		Min. Value of Input Choke,				
Max. Peak Inverse Volts, 1250				Max. Peak Plate mA, 245		10 henries				
125	— 1V	—	—	12	6000	6500	40	—	—	6X8
125	— 1V	125	2.2	9	300000	5500	—	—	—	6X8
Max. AC Volts per Plate (RMS), 350				Max. Plate Dissipation, 3.5 watts						6Y5
Max. DC Output mA, 50				Max. Peak Heater-Cathode Volts, —2300, +300						
For other characteristics, refer to Type 79										6Y7G
170	— 2.6	170	6.5	30	—	21000	38	—	—	6Y9
150	— 2.3	150	3	10	—	8500	35	—	—	6Y9
Max. AC Volts per Plate (RMS), 230										6Z4
Max. DC Output mA, 60										6Z5
180	0V	Power Output is for one tube at stated plate-to-plate load					12000	4.2	—	6Z7G
For other characteristics, refer to Type 6Z10/6J10										6Z10
Max. Peak Inverse Volts, 1250				Max. DC Output mA, 40		Min. Total Effect. Supply				6ZY5G
				Max. Peak Plate mA, 120		Imped. per Plate, 225 ohms				

† For two tubes at stated plate-to-plate load.

□ For two tubes.

RCA Type	Name	Out- line	Terminal Dia- gram	Heater or Filament (F)		Use Values to right give operat- ing conditions and character- istics for indicated typical use
				Volts	Amperes	
				7A4	Medium-Mu Triode	
7A5	Beam Power Tube	12C	6AA	6.3	0.75	Class A Amplifier
7A6	Twin Diode	12B	7AJ	6.3	0.15	Detector Rectifier
7A7	Remote-Cutoff Pentode	12B	8V	6.3	0.3	Class A Amplifier
7A8	Octode Converter	12B	8U	6.3	0.15	Converter
7AD7	Power Pentode	12C	8V	6.3	0.6	Class A Amplifier
7AF7	Medium-Mu Twin Triode	12B	8AC	6.3	0.3	Each Unit as Class A Amplifier
7AG7	Sharp-Cutoff Pentode	12B	8V	6.3	0.15	Class A Amplifier
7AH7	Sharp-Cutoff Pentode	12B	8V	6.3	0.15	Class A Amplifier
7B4	High-Mu Triode	12B	5AC	6.3	0.3	Amplifier
7B5	Power Pentode	12C	6AE	6.3	0.4	Class A Amplifier
7B6	Twin Diode—High-Mu Triode	12B	8W	6.3	0.3	Triode Unit as Amplifier
7B7	Remote-Cutoff Pentode	12B	8V	6.3	0.15	Class A Amplifier
7B8	Pentagrid Converter	12B	8X	6.3	0.3	Converter
7C5	Beam Power Tube	12C	6AA	6.3	0.45	Class A Amplifier
7C6	Twin Diode—High-Mu Triode	12B	8W	6.3	0.15	Triode Unit as Class A Amplifier
7C7	Sharp-Cutoff Pentode	12B	8V	6.3	0.15	Class A Amplifier
7D18/ PCC88	Dual Triode	6B	9DE	7	0.3	Each Unit as Class A Amplifier
7E6	Twin Diode—Medium-Mu Triode	12B	8W	6.3	0.3	Triode Unit as Amplifier
7E7	Twin Diode—Remote-Cutoff Pentode	12B	8AE	6.3	0.3	Pentode Unit as Class A Amplifier
7EY6	Beam Power Tube	13F	7AC	7.2	0.6	Vertical Deflection Amplifier
7F7	High-Mu Twin Triode	12B	8AC	6.3	0.3	Each Unit as Amplifier
7F8	Medium-Mu Twin Triode	12A	8BW	6.3	0.3	Each Unit as Class A Amplifier
7G7	Sharp-Cutoff Pentode	12B	8V	6.3	0.45	Class A Amplifier
7H7	Semiremote-Cutoff Pentode	12B	8V	6.3	0.3	Class A Amplifier
7HG8	Medium-Mu Triode— Sharp-Cutoff Pentode	6B	9MP	7.2	0.3	Triode Unit as Class A Amplifier Pentode Unit as Class A Amplifier
7J7	Triode-Heptode Converter	12B	8BL	6.3	0.3	Triode Unit as Oscillator Heptode Unit as Mixer
7K7	Twin Diode—High-Mu Triode	12B	8BF	6.3	0.3	Triode Unit as Class A Amplifier
7KZ6	Sharp-Cutoff Pentode	6E	9GK	7.3	0.45	Class A Amplifier
7L7	Sharp-Cutoff Pentode	12B	8V	6.3	0.3	Class A Amplifier
7N7	Medium-Mu Twin-Triode	12C	8AC	6.3	0.6	Each Unit as Class A Amplifier
7Q7	Pentagrid Converter	12B	8AL	6.3	0.3	Converter
7R7	Twin Diode—Remote-Cutoff Pentode	12B	8AE	6.3	0.3	Pentode Unit as Class A Amplifier
7S7	Triode-Heptode Converter	12B	8BL	6.3	0.3	Triode Unit as Oscillator Heptode Unit as Mixer
7V7	Sharp-Cutoff Pentode	12B	8V	6.3	0.45	Class A Amplifier
7W7	Sharp-Cutoff Pentode	12B	8BJ	6.3	0.45	Class A Amplifier
7X7	Twin Diode—High-Mu Triode	12C	8BZ	6.3	0.3	Triode Unit as Class A Amplifier
7Y4	Full-Wave Rectifier	12B	5AB	6.3	0.5	With Capacitive-Input Filter

Plate Volts	Grid Bias or Cathode Resistor	Screen Grid Volts	Screen Grid Cur- rent mA	Plate Cur- rent mA	AC Plate Resist- ance Ohms	Trans- conduc- tance Micromhos	Amplifi- cation Factor	Power		RCA Type	
								Load Ohms	Out- put Watts		
For other characteristics, refer to Type 6J5										7A4	
110	— 7.5V	110	3.0	40.0	16000	5800	—	2500	1.5	7A5	
125	— 9V	125	3.3	44.0	17000	6000	—	2700	2.2	7A5	
Max. AC Voltage per Plate, 150 Volts, RMS						Max. DC Output Current per plate, 8 mA				7A6	
For other characteristics, refer to Type 6SK7										7AF7	
250	— 3V	100	3.2	3.0	700000	Anode-Grid (2): 250 max. volts, 4.2 mA Oscillator-Grid No. 1 Resistor. Con- version Transcond., 550 micromhos		—	—	7A8	
300	68Ω	150	7.0	28.0	300000	9500	—	—	—	7AD7	
250	—10V	—	—	9.0	7600	2100	16	—	—	7AF7	
250	250Ω	250	2.0	6.0	1 M	4200	—	—	—	7AG7	
250	250Ω	250	1.9	6.8	1 M	3300	—	—	—	7AH7	
For other characteristics, refer to Type 6SF5										7B4	
For other characteristics, refer to Type 6K6GT										7B5	
For other characteristics, refer to Type 6SQ7										7B6	
250	— 3V	100	1.7	8.5	—	750000	1750	—	—	7B7	
For other characteristics, refer to Type 6A8										7B8	
For other characteristics, refer to Type 6V6										7C5	
250	— 1V	—	—	1.3	100000	1000	100	—	—	7C6	
250	— 3V	100	0.5	2.0	2 M	1300	—	—	—	7C7	
90	—1.3	—	—	15	—	12500	33	—	—	7DJ8/ PCC88	
For other characteristics, refer to Type 6BF6										7E6	
250	330Ω	100	1.6	7.5	700000	1300	—	—	—	7E7	
For other characteristics, refer to Type 6EY6										7EY6	
For other characteristics, refer to Type 6SL7GT										7F7	
250	500Ω	—	—	6.0	—	3300	48	—	—	7F8	
250	— 2V	100	2.0	6.0	800000	4500	—	—	—	7G7	
100	— 1.5V	100	2.6	7.5	350000	4000	—	—	—	7H7	
250	180Ω	150	3.2	10.0	800000	4000	—	—	—	7H7	
For other characteristics, refer to Type 6HG8										7HG8	
250	Triode-Grid Resistor, 50000 ohms		5.0		Triode-Grid & Heptode-Grid Current, 0.4 mA					7J7	
250	— 3V	100	2.8	1.4	1.5 M	Conversion Transcond., 290 μmhos				7J7	
250	— 2V	—	—	2.3	44000	1600	70	—	—	7K7	
250	75Ω	115	3.6	25	45000	24000	—	—	—	7KZ6	
100	— 1V	100	2.4	5.5	100000	3000	—	—	—	7L7	
250	— 1.5V	100	1.5	4.5	1 M	3100	—	—	—	7L7	
For other characteristics, refer to Type 6SN7GT										7N7	
250	— 2V	100	8.5	3.5	1 M	Grid No. 1 Resistor, 20000 ohms Conversion Transcond., 450 μmhos				7Q7	
250	— 1V	100	2.1	5.7	1 M	3200	—	—	—	7R7	
100	Triode-Grid Resistor, 50000 ohms		3.0		—					—	—
250	—		5.0		—					—	—
250	— 2V	100	3.0	1.8	1.25 M	Conversion Transcond., 525 μmhos				7S7	
300	160Ω	150	3.9	10.0	300000	5800	—	—	—	7V7	
For other characteristics, refer to Type 7V7										7W7	
250	— 1V	—	—	1.9	67000	1500	100	—	—	7X7	
Max. Peak Inverse Volts, 1250				Max. DC Output mA, 70			Max. Peak Plate mA, 180				7Y4

RCA Type	Name	Out- line	Terminal Dia- gram	Heater or Filament (F)		Use Values to right give operat- ing conditions and character- istics for indicated typical use
				Volts	Amperes	
7Z4	Full-Wave Rectifier	12C	5AB	6.3	0.9	With Capacitive-Input Filter
8AL9	High-Mu Triode Sharp-Cutoff Pentode	8C	12HE	8.6	0.6	Triode Unit as Class A Amplifier
						Pentode Unit as Class A Amplifier
8BH8	Medium-Mu Triode Sharp-Cutoff Pentode	6E	9DX	8.4	0.45	Triode Unit as Class A Amplifier Pentode Unit as Class A Amplifier
8BN11	Sharp-Cutoff Twin Pentode	8B	12GF	8.4	0.6	Each Unit as Class A Amplifier
8CB11	Sharp-Cutoff Twin Pentode	8B	12DM	8.4	0.6	Each Unit as Class A Amplifier
8CN7	Twin Diode—High-Mu Triode	6B	9EN	8.4	4.2	Triode Unit as Class A Amplifier
8EB8	High-Mu Triode Sharp-Cutoff Pentode	6E	9DX	6.3	0.75	Triode Unit as Class A Amplifier
						Pentode Unit as Class A Amplifier
8E77	Twin Diode— Sharp-Cutoff Pentode	6E	9LT	8	0.6	Pentode Unit as Class A Amplifier
8FQ7	Medium-Mu Twin Triode	6E	9LP	8.4	0.45	Vertical and Horizontal Deflection Oscillators
8GJ7	Medium-Mu Triode— Sharp-Cutoff Pentode	6J	9QA	8	0.3	Triode Unit as Class A Amplifier
						Pentode Unit as Class A Amplifier
9A8	Medium-Mu Triode— Sharp-Cutoff Pentode	6B	9DC	9	0.3	Triode Unit as Class A Amplifier
						Pentode Unit as Class A Amplifier
9AH9	Medium-Mu Triode Sharp-Cutoff Pentode	8B	12HJ	8.8	0.6	Triode Unit as Class A Amplifier Pentode Unit as Class A Amplifier
9AK10	High-Mu Triple Triode	8C	12FE	9.5	0.6	Each Unit as Class A Amplifier
9AM10	High-Mu Triple Triode	8C	12FE	9.5	0.6	Each Unit as Class A Amplifier
9AQ8/ PCC85	High-Mu Twin Triode	6B	9DE	9.0	0.3	Each Unit as Class A Amplifier
9BJ11	Beam Power Tube Sharp-Cutoff Pentode	8B	12FU	9.6	0.45	Beam Unit as Class A Amplifier Pentode Unit as Class A Amplifier
9BR7	Twin Diode—High-Mu Triode	6B	9CF	4.7	0.6	Triode Unit as Class A Amplifier
				9.4	0.3	
9CL8	Medium-Mu Triode—Sharp-Cutoff Tetrode	6B	9FX	9.5	0.3	Triode Unit as Class A Amplifier
						Tetrode Unit as Class A Amplifier
9EA8	Medium-Mu Triode— Sharp-Cutoff Pentode	6B	9AE	9.5	0.15	Triode Unit as Class A Amplifier Pentode Unit as Class A Amplifier
9GV8	High-Mu Triode— Power Pentode	6E	9LY	9.5	0.6	Triode Unit as Class A Amplifier
						Pentode Unit as Class A Amplifier
9KC6	Sharp-Cutoff Pentode	6E	9RF	8.7	0.45	Class A Amplifier
9LA6	Sharp-Cutoff Pentode	6E	9GK	8.7	0.45	Class A Amplifier
9U8A	Medium-Mu Triode— Sharp-Cutoff Pentode	6B	9AE	9.45	0.3	Class A Amplifier
10	Power Triode	27B	4D	7.5F	1.25	Class A Amplifier
10C8	High-Mu Triode—Sharp-Cutoff Pentode	6B	9DA	10.5	0.3	Triode Unit as Class A Amplifier
						Pentode Unit as Class A Amplifier
10CW5	Power Pentode	6E	9CV	10.6	0.45	Vertical Deflection Amplifier
10DX8	High-Mu Triode— Sharp-Cutoff Pentode	6E	9HX	10.2	0.45	Triode Unit as Class A Amplifier
						Pentode Unit as Class A Amplifier
10EG7	Dual Triode	13B	8BD	9.7	0.6	Class A Amplifier
10GF7	Dual Triode	11A	9QD	9.7	0.6	Vertical Deflection Amplifier
						Vertical Deflection Oscillator
10JA5	Beam Power Tube	15D	12EY	10.5	0.6	Vertical Deflection Amplifier

Plate Volts	Grid Bias or Cathode Resistor	Screen Grid Volts	Screen Grid Cur- rent mA	Plate Cur- rent mA	AC Plate Resist- ance Ohms	Trans- conduc- tance Micromhos	Amplifi- cation Factor	Power		RCA Type
								Load Ohms	Out- put Watts	
Max. Peak Inverse Volts, 1250			Max. DC Output mA, 100 Max. Peak Plate mA, 300			Min. Total Effec. Supply Imped. per Plate, 75 ohms				7Z4
200	270Ω	—	—	7.6	9200	6300	59	—	—	8AL9
250	56Ω	150	5.6	28	40000	30000	—	—	—	
55	0V	125	21	56	Instantaneous Plate Knee characteristic					
For other characteristics, refer to Type 6BH8										8BH8
For other characteristics, refer to Type 6BN11										8BN11
125	56Ω	125	3.8	11	200000	13000	—	—	—	8CB11
For other characteristics, refer to Type 6CN7										8CN7
250	—	—	—	2	37000	2700	100	—	—	8EB8
200	68Ω	125	7	25	75000	12500	—	—	—	
For other characteristics, refer to Type 6ET7										8ET7
For other characteristics, refer to Type 6FQ7										8FQ7
For other characteristics, refer to Type 6GJ7										8GJ7
100	— 2V	—	—	14	—	5000	20	—	—	9A8
170	— 2V	170	2.8	10	400000	6200	Ampl. Factor. (Grid No. 2 to Grid No. 1), 47		—	
For other characteristics, refer to Type 6AH9										9AH9
For other characteristics, refer to Type 6AK10										9AK10
100	200Ω	—	—	8	9300	6900	64	—	—	9AM10
200	—2V	—	—	10	—	5800	48	—	—	9AQ8/ PCC85
125	120Ω	125	2.5	8.5	40000	9600	—	—	—	9BJ11
110	0V	110	6.8	5.8	40000	7500	(Grid No. 1 = 10000Ω)			
250	200Ω	—	—	10	10900	4000	60	—	—	9BR7
125	56Ω	—	—	15	5000	8000	40	—	—	9CL8
125	— 1V	125	4	12	100000	5800	—	—	—	
For other characteristics, refer to Type 6EA8										9EA8
For other characteristics, refer to Type 6GV8										9GV8
250	56Ω	150	9	18	55000	24000	(E _{ca} = 0V)		9KC6	
50	0V	100	25	25	Instantaneous Plate Knee characteristic					
50	0V	125	32	76	—	—	—	—	—	9LA6
250	0V	150	6	25	55000	21000	—	—	—	
For other characteristics, refer to Type 6U8A										9U8A
425	—40V	—	—	18.0	5000	1600	8.0	10200	1.6	10
250	390Ω	—	—	7.3	12000	4400	53	—	—	10C8
135	100Ω	135	3.2	11.5	190000	8000	—	—	—	
For other ratings, refer to Type 6CW5										10CW5
For other characteristics, refer to Type 6DX8										10DX8
For other characteristics, refer to Type 6EW7										10EG7
For other ratings, refer to Type 6GF7										10GF7
For other characteristics, refer to Type 6JA5										10JA5

RCA Type	Name	Out-line	Terminal Diagram	Heater or Filament (F)		Use Values to right give operating conditions and characteristics for indicated typical use
				Volts	Amperes	
10JA8	High-Mu Triode Sharp-Cutoff Pentode	6E	9DX	10.5	0.45	Class A Amplifier
10LB8	Medium-Mu Triode Sharp-Cutoff Pentode	10A	9DX	10.2	0.45	Class A Amplifier
10LW8	High-Mu Triode Sharp-Cutoff Pentode	6E	9DX	10.5	0.45	Triode Unit as Class A Amplifier Pentode Unit as Class A Amplifier
10LZ8	High-Mu Triode—Sharp-Cutoff Pentode	6E	9DX	10.5	0.45	Triode Unit as Class A Amplifier Pentode Unit as Class A Amplifier
11	Detector Amplifier	4F	4F	1.1F	0.25	Class A Amplifier
11CA11	Dual Triode Sharp-Cutoff Pentode	8B	12HN	10.7	0.6	Triode Unit 1 as Class A Amplifier Triode Unit 2 as Class A Amplifier Pentode Unit as Class A Amplifier
11CF11	Dual Triode Sharp-Cutoff Pentode	8B	12HW	10.7	0.6	Triode Unit 1 as Class A Amplifier Triode Unit 2 as Class A Amplifier Pentode Unit as Class A Amplifier
11CH11	Dissimilar Double Triode Sharp-Cutoff Pentode	8B	12G3	10.7	0.6	Triode Unit 1 as Class A Amplifier Triode Unit 2 as Class A Amplifier Pentode Unit as Class A Amplifier
11CY7	Dual Triode	6E	9LG	11	0.45	Vertical Deflection Oscillator and Amplifier
11JE8	High-Mu Triode Sharp-Cutoff Pentode	6E	9DK	10.9	0.45	Class A Amplifier
11Y9	Dual Pentode	8L	10L	11	0.45	Unit No. 1 as Class A Amplifier Unit No. 2 as Class A Amplifier
12A5	Power Pentode	22 or 13H	7F	6.3 12.6	0.6 0.3	Class A Amplifier
12A5 [†] 12A5Y [†]	Beam Power Tube	2B	7AC	12.6	0.15	Class A Amplifier
12A7	Rectifier—Power Pentode	24B	7K	12.6	0.3	Pentode Unit as Class A Amplifier Half-Wave Rectifier
12A8GT	Pentagrid Converter	14A	8A	12.6	0.15	Converter
12AC6	Remote-Cutoff Pentode	5C	7BK	10.0 to 15.9	0.15 approx. at 12.6 V	Class A Amplifier
12AD6	Pentagrid Converter	5C	7CH	10.0 to 15.9	0.15 approx. at 12.6 V	Converter
12AE6	Twin Diode—Medium-Mu Triode	5C	7BT	10.0 to 15.9	0.15 approx. at 12.6 V	Triode Unit as Class A Amplifier
12AE6A	Twin Diode—Medium-Mu Triode	5C	7BT	10.0 to 15.9	0.15 approx. at 12.6 V	Triode Unit as Class A Amplifier
12AE7	Dual Triode	6B	9A	10.0 to 15.9	0.45 approx. at 12.6 V	Unit No. 1 as Class A Amplifier Unit No. 2 as Class A Amplifier
12AF6	Remote-Cutoff Pentode	5C	7BK	10.0 to 15.9	0.15 approx. at 12.6 V	Class A Amplifier
12AH7 GT	Medium-Mu Twin Triode	13C	8BE	12.6	0.15	Each Unit as Class A Amplifier
12AJ6	Twin Diode—Medium-Mu Triode	5C	7BT	10.0 to 15.9	0.15 approx. at 12.6 V	Triode Unit as Class A Amplifier

[†] Industrial type

Plate Volts	Grid Bias or Cathode Resistor	Screen Grid Volts	Screen Grid Cur- rent mA	Plate Cur- rent mA	AC Plate Resist- ance Ohms	Trans- conduc- tance Micromhos	Amplifi- cation Factor	Power		RCA Type
								Load Ohms	Out- put Watts	
For other characteristics, refer to Type 10JA8/10LZ8										10JA8
For other characteristics, refer to Type 6LB8										10LB8
200	-2V	—	—	2.6	18700	4000	75	—	—	10LW8
200	82Ω	100	2.8	16.5	60000	19000	—	—	—	
35	0	100	12.5	48	Instantaneous Plate Knee characteristic					
250	-2	—	—	1.1	52000	2100	110	—	—	10LZ8
200	0	140	2.5	12	150000	9500	—	—	—	11
135	-10.5V	—	—	3	15500	440	—	—	—	11
200	270Ω	—	—	7.6	9200	6300	59	—	—	11CA11
200	270Ω	—	—	7.1	12400	5500	69	—	—	
200	65Ω	120	4.9	27.5	490000	21200	—	—	—	
40	0V	120	17.6	68	Instantaneous Plate Knee characteristic					
200	270Ω	—	—	7.1	12400	5500	69	—	—	11CF11
200	270Ω	—	—	7.6	9200	6300	59	—	—	
200	65Ω	120	4.9	27.5	490000	21200	—	—	—	
40	0V	120	17.6	68	Instantaneous Plate Knee characteristic					
200	270Ω	—	—	7.1	12500	5500	69	—	—	11CH11
200	470Ω	—	—	7.2	7600	5300	40	—	—	
200	65Ω	120	4.9	27.5	490000	20000	—	—	—	
50	0V	120	18	71	Instantaneous Plate Knee characteristic					
For other characteristics, refer to Type 6CY7										11CY7
For other characteristics, refer to Type 6JE8										11JE8
170	-2.6	170	6.5	30	—	21000	Ampl. Factor (Grid-No. 1 to Grid-No. 2), 38			11Y9
150	-2.3	150	3	10	—	8500	Ampl. Factor (Grid-No. 1 to Grid No. 2), 35			
180	-25V	180	8.0	45.0	35000	2400	—	3300	3.4	12A5
250	-12.5V	250	3.5	30	70000	3000	—	7000	3.4	12A6 ⁺ 12AGY ⁺
135	-13.5V	135	2.5	9.0	100000	975	—	13500	0.55	12A7
Maximum AC Plate Voltage.....							125 Volts, RMS			
Maximum DC Output Current.....							30 Milliamperes			
For other characteristics, refer to Type 6A8GT										12A8GT
12.6	—	12.6	.2	.55	500000	730	{Grid-No. 1 Supply Volts, 0 Grid-No. 1 Res., 2.2 megohms}			12AC6
12.6	Self- excited	12.6	1.5	0.45	1 M	Grid-No. 1 Resistor, 33000 ohms Conversion Transcond., 260 micromhos				12AD6
12.6	0V	—	—	0.75	15000	1000	15	—	—	12AE6
12.6	0V	—	—	1	13000	1300	16.7	—	—	12AEG6A
12.6	Grid Res. 1.5 megohms	—	—	1.9	3150	4000	13.0	—	—	12AE7
12.6	Grid Res. 1 megohm	—	—	7.5	985	6500	6.4	—	—	12AF6
12.6	—	12.6	0.45	1.1	350000	1500	{Grid-No. 1 Supply Volts, 0 Grid-No. 1 Res., 2.2 megohms}			
180	-6.5V	—	—	7.6	8400	1900	16	—	—	12AH7 GT
12.6	{Grid-No. 1 Supply Volts, 0 Grid-No. 1 Res., 2.2 megohms}			0.75	45000	1200	55	—	—	12AJ6

RCA Type	Name	Out-line	Terminal Diagram	Heater or Filament (F)		Use Values to right give operating conditions and characteristics for indicated typical use
				Volts	Amperes	
12AL8	Medium-Mu Triode—Power Tetrode	6E	9CS	10.0 to 15.9	0.55 approx. at 12.6 V	Triode Unit as Class A Amplifier Tetrode Unit as Class A Amplifier
12AT7WA♦ 12AT7WB♦	High-Mu Twin Triode	6B	9A	12.6 6.3	0.15 0.3	Class A Amplifier
12AU7	Medium-Mu Twin Triode	6B	9A	6.3 12.6	0.3 0.15	Each Unit as Class A Amplifier
12AV7	Medium-Mu Twin Triode	6B	9A	6.3 12.6	0.45 0.225	Each Unit as Class A Amplifier
12AW6	Sharp-Cutoff Pentode	5C	7CM	12.6	0.15	Class A Amplifier
12AX4-GT 12AX4-GTA	Half-Wave Rectifier	13D 13D	4CG	12.6 12.6	0.6 0.6	Television Damper Service
12AX7	High-Mu Twin-Triode	6B	9A	6.3 12.6	0.3 0.15	Each Unit as Class A Amplifier
12AY3	Half-Wave Rectifier	11D	9HP	12.6	0.6	Television Damper Service
12AZ7	High-Mu Twin-Triode	6B	9A	6.3 12.6	0.45 0.225	Each Unit as Class A Amplifier
12B8GT	High-Mu Triode—Remote-Cutoff Pentode	—	8T	12.6	0.3	Triode Unit as Class A Amplifier Pentode Unit as Class A Amplifier
12BA7	Pentagrid Converter	6E	8CT	12.6	0.15	Converter
12BD6	Remote-Cutoff Pentode	5C	7BK	12.6	0.15	Class A Amplifier
12BF6	Twin Diode—Medium-Mu Triode	5C	7BT	12.6	0.15	Triode Unit as Class A Amplifier
12BH7	Medium-Mu Twin Triode	6E	9A	6.3 12.6	0.6 0.3	Vertical Deflection Amplifier
12BK5	Beam Power Tube	6E	9BQ	12.6	0.6	Class A Amplifier
12BL6	Remote-Cutoff Pentode	5C	7BK	10.0 to 15.9	0.15 approx. at 12.6V	Class A Amplifier
12BN6	Beam Tube	5D	7DF	12.6	0.15	Limiter and Discriminator
12BR7	Twin Diode—High-Mu Triode	6B	9CF	6.3 12.6	0.45 0.225	Triode Unit as Class A Amplifier
12BS3	Half-Wave Rectifier	11D	9HP	12.6	0.6	Television Damper Service
12BT3	Half-Wave Rectifier	8C	12BL	12.6	0.45	Television Damper Service
12BV7	Sharp-Cutoff Pentode	6E	9BF	6.3 12.6	0.6 0.3	Class A Amplifier
12BW4	Full-Wave Rectifier	6E	9DJ	6.3	0.9	With Capacitive Input Filter With Inductive Input Filter
12BY7	Sharp-Cutoff Pentode	6E	9BF	6.3 12.6	0.6 0.3	Class A Amplifier
12BZ7	High-Mu Twin Triode	6E	9A	12.6	0.3	Each Unit as Class A Amplifier
12C8	Twin Diode—Semiremote-Cutoff Pentode	3	8E	12.6	0.15	Pentode Unit as RF Amplifier
12CK3	Half-Wave Rectifier	30B	9HP	12.6	0.6	Television Damper Service
12CN5	Remote-Cutoff Pentode	5D	7CV	10.0 to 15.9	0.45 approx. at 12.6V	Class A Amplifier
12CR6	Diode-Remote-Cutoff Pentode	5C	7EA	6.3	0.3	Pentode Unit as Class A Amplifier
12CT8	Medium-Mu Triode—Sharp-Cutoff Pentode	6E	9DA	12.6	0.3	Triode Unit as Class A Amplifier Pentode Unit as Class A Amplifier

♦ Industrial Type

CHARACTERISTICS CHART

Plate Volts	Grid Bias or Cathode Resistor	Screen Grid Volts	Screen Grid Cur- rent mA	Plate Cur- rent mA	AC Plate Resist- ance Ohms	Trans- conduct- ance Micromhos	Amplifi- cation Factor	Power		RCA Type
								Load Ohms	Out- put Watts	
12.6	— 0.9V (across 2.2 megohm res.)	—	—	.5	13000	1000	13	—	—	12AL8
Grid-No. 2 (Control Grid) Volts, —.5 (across 2.2 megohm res.)					Ampl. Factor (Grid-No. 2 to Plate) 7.2					
Grid-No. 1 (Space-Charge Grid) Volts, 12.6					Grid-No. 1 mA, 75 Plate mA, 40					
Transcond. (Grid-No. 2 to Plate), 15000 μ hos					Plate Resistance, 480 ohms					
For other characteristics, refer to Type 12AT7										12AT7WA* 12AT7WB*
100	0V	—	—	11.8	6250	3100	19.5	—	—	12AU7
250	— 8.5V	—	—	10.5	7700	2200	17	—	—	
150	56 Ω	—	—	18	4800	8500	41	Cutoff Volts, —12		12AV7
For other characteristics, refer to Type 6AG5										12AW6
Max. Peak Inverse Plate Volts, 4400					Max. Peak Heater-Cathode Volts: { —4400 +300					12AX4- GT
Max. Peak Plate mA, 750					DC component must not exceed 900 volts					12AX4- GTA
Max. DC Plate mA, 125										
100	— 1V	—	—	0.5	80000	1250	100	—	—	12AX7
250	— 2V	—	—	1.2	62500	1600	100	—	—	
For other ratings, refer to Type 6AY3										12AY3
100	270 Ω	—	—	3.7	15000	4000	60	—	—	12AZ7
250	200 Ω	—	—	10.0	10900	5500	60	—	—	
90	0V	—	—	2.8	37000	2400	90	—	—	
90	— 3V	90	2	7	200000	1800	—	—	—	12B8GT
For other characteristics, refer to Type 6BA7										12BA7
For other characteristics, refer to Type 6BD6										12BD6
250	— 9V	—	16	1900	9.5	8500	—	Power Output, 300 milliwatts		12BF6
Max. DC Plate Volts, 450					Absolute Max. Peak Positive-Pulse Plate Volts, 1500					12BH7
Max. DC Plate mA, 20					Max. Plate Dissipation (Each Unit), 3.5 watts					
250	— 5V	250	3.5	35	100000	8500	—	6500	3.5	12BK5
12.6	Grid-No. 1 Supply Volts, 0	12.6	0.5	1.35	500000	1350	Grid-No. 1 and Grid-No. 3 Volts for transcond. of 10 micromhos, —5			12BL6
For other characteristics, refer to Type 6BN6/6KS6										12BN6
100	270 Ω	—	—	3.7	15000	4000	60	—	—	12BR7
250	200 Ω	—	—	10	10900	5500	60	—	—	
For other ratings, refer to Type 6BS3										12BS3
Max. Peak Inverse Plate Volts, 3300					Max. Average Plate mA, 165					12BT3
Max. Peak Plate mA, 1000					Max. Peak Heater-Cathode Volts: { —3300 +300					
250	68 Ω	150	6	27	85000	13000	—	—	—	12BV7
250	— 8V	180	—	0.5	—	—	—	—	—	
For other characteristics, refer to Type 6BW4										12BW4
250	100 Ω	180	5.75	26	93000	11000	—	—	—	12BY7
250	— 2V	—	—	2.5	31800	3200	100	—	—	12BZ7
250	— 3V	125	2.3	10	600000	1325	—	—	—	12C8
For other characteristics, refer to Type 6CK3										12CK3
12.6	—	12.6	3.5	4.5	40000	3800	{Grid-No. 1 Supply Volts, 0 Grid-No. 1 Res., 2.2 megohms}			12CN5
For other characteristics, refer to Type 6CR6										12CR6
150	150 Ω	—	—	9	8200	4900	40	—	—	12CT8
200	82 Ω	125	3.4	15	150000	7000	—	—	—	

RCA Type	Name	Out- line	Terminal Dia- gram	Heater or Filament (F)		Use Values to right give operat- ing conditions and character- istics for indicated typical use
				Volts	Amperes	
12CX6	Remote-Cutoff Pentode	5C	7BK	10.0 to 15.9	0.15 approx. at 12.6V	Class A Amplifier
12D4	Half-Wave Rectifier	13D	4CG	12.6	0.6	Television Damper Service
12DB5	Beam Power Tube	6F	9GR	12.6	0.6	Class A Amplifier
12DE8	Diode—Remote-Cutoff Pentode	6B	9HG	10.0 to 15.9	0.2 approx. at 12.6V	Pentode Unit as Class A Amplifier
12DK7	Twin Diode—Power Tetrode	6E	9HZ	10.0 to 15.9	0.5 approx. at 12.6V	Tetrode Unit as Class A Amplifier
12DL8	Twin Diode—Power Tetrode	6E	9HR	10.0 to 15.9	0.55 approx. at 12.6V	Tetrode Unit as Class A Amplifier
12DM4 12DM4A	Half-Wave Rectifier	13F 13G	4CG	12.6	0.6	Television Damper Service
12DQ6A	Beam Power Tube	20A	6AM	12.6	0.6	Horizontal Deflection Amplifier
12DQ6B	Beam Power Tube	20A	6AM	12.6	0.6	Horizontal Deflection Amplifier
12DQ7	Power Pentode	6E	9BF	6.3 12.5	0.6 0.3	Class A Amplifier
12DS7 12DS7A	Twin Diode—Power Tetrode	6E 6E	9JU	10.0 to 15.9	0.4 approx. at 12.6V	Tetrode Unit as Class A Amplifier
Diode Units						
12DU7	Twin Diode—Power Tetrode	6B	9JX	10.0 to 15.9	0.25 approx. at 12.6V	Tetrode Unit as Class A Amplifier
12DV8	Twin Diode—Power Tetrode	6E	9HR	10.0 to 15.9	0.375 approx. at 12.6V	Class A Amplifier
12DW4A	Half-Wave Rectifier	11D	9HP	12.6	0.6	Television Damper Service
12DW7	Dual Triode	6B	9A	12.6 6.3	0.15 0.3	Unit No. 1 as Class A Amplifier Unit No. 2 as Class A Amplifier
12DY8	Medium-Mu Triode— Remote-Cutoff Tetrode	6B	9JD	10.0 to 15.9	0.35 approx. at 12.6V	Triode Unit as Class A Amplifier Tetrode Unit as Signal Seeker Relay
12DZ6	Remote-Cutoff Pentode	5C	7BK	10.0 to 15.9	0.19 approx. at 12.6V	Class A Amplifier
12EA6	Remote-Cutoff Pentode	5C	7BK	10.0 to 15.9	0.19 approx. at 12.6V	Class A Amplifier
12EC8	Medium-Mu Triode— Semiremote-Cutoff Pentode	6B	9FA	10.0 to 15.9	0.225 approx. at 12.6V	Triode Unit as Class A Amplifier Pentode Unit as Class A Amplifier
12ED5	Beam Power Tube	5D	7CV	12.6	0.45	Class A Amplifier
12EG6	Pentagrid Amplifier	5C	7CH	10.0 to 15.9	0.15 approx. at 12.6V	Class A Amplifier
12EH5	Power Pentode	5D	7CV	12.6	0.6	Push-Pull Class AB, Amplifier
12EK6/ 12DZ6/ 12EA6	Remote-Cutoff Pentode	5C	7BK	10.0 to 15.9	0.19 approx. at 12.6V	Class A Amplifier
12EL6	Twin Diode—High-Mu Triode	5C	7FB	10.0 to 15.9	0.15 approx. at 12.6V	Class A Amplifier

Plate Volts	Grid Bias or Cathode Resistor	Screen Grid Volts	Screen Grid Cur- rent mA	Plate Cur- rent mA	AC Plate Resist- ance Ohms	Trans- conduc- tance Micromhos	Amplifi- cation Factor	Power		RCA Type
								Lead Ohms	Out- put Watts	
12.6	Grid-No. 1 Supply Volts, 0	12.6	1.4	3	40000	3100	Grid-No. 1 Volts for Plate Current of 10 μ A, -4.5			12CX6
	Max. Peak Inverse Plate Volts, 4400 Max. Peak Plate mA, 900 Max. Average Plate mA, 155						Max. Peak Heater-Cathode Volts, -4400, +300			12D4
200	180 Ω	125	2.2	46	28000	8000	Plate Dissipation 5.5 watts	4000	3.8	12DB5
12.6	—	12.6	0.5	1.3	300000	1500	Grid No. 1 Supply Volts, 0 Grid-No. 1 Res., 2.2 megohms			12DE8
12.6	—	12.6	1	6	4000	5000	—	3500	0.010	12DK7
12.6	Grid-No. 2 (Control Grid) Volts, -0.5 (across 2.2 megohm resistor) Grid-No. 1 (Space-Charge Grid) Volts, 12.6 Transcond. (Grid-No. 2 to Plate), 15000 μ mhos						Ampl. Factor (Grid-No. 2 to Plate) 7.2 Grid-No. 1 mA, 75 Plate Resistance, 480 ohms			12DL8
	For other characteristics, refer to Type 6DM4									12DM4 12DM4A
	Max. DC Plate Volts, 700 Max. DC Cathode mA, 140						Max. Peak Positive-Pulse Plate Volts, 6000 (Abs.) Max. Plate Dissipation, 15 watts			12DQ6A
	For other ratings, refer to Type 6DQ6B									12DQ6B
200	68 Ω	125	5.6	26	53000	10500	—	—	—	12DQ7
12.6	12.6V	-0.5 (across 2.2 megohm resistor)	75 (Grid- No. 1)	35	500	19000 (Grid- No. 2 to Plate)	9.1 (Grid- No. 2 to Plate)	—	—	12DS7 12DS7A
	Diode Plate mA, with 10 Volts Applied, 3 mA									
12.6	—	12.6	1.5	12	6000	6200	—	2700	0.025	12DU7
	Grid-No. 2 (Control Grid) Resistor, 4.7 megohms Grid-No. 1 (Space-Charge Grid) Volts, 12.6 Transcond. (Grid-No. 2 to Plate), 8500 μ mhos						Ampl. Factor (Grid-No. 2 to Plate) 7.6 Grid-No. 1 mA, 53 Plate Resistance, 900 ohms			12DV8
	For other characteristics, refer to Type 6DW4A									12DW4A
250	- 2V	—	—	1.2	62500	—	100	—	—	12DW7
250	- 8.5V	—	—	10.5	7700	2200	17	—	—	
12.6	—	—	—	1.2	10000	2000	20	—	—	
10	—	10	—	5 min.	Grid No. 1 resistor 10 megohms.	—	—	—	Plate Load 700 ohms	12DY8
15	- 6V	15	—	3 max.	—	—	—	—	Plate Load 700 ohms	
12.6	Grid-No.1 Supply Volts, 0	12.6	2.2	4.5	25000	3800	—	—	—	12DZ6
12.6	—	12.6	1.4	3.2	32000	3800	{Grid-No. 1 Supply Volts, 0 Grid-No. 1 Res., 10 megohms}			12EA6
12.6	4700 Ω (Grid Res.)	—	—	2.4	6000	4700	25	—	—	12EC8
12.6	—	12.6	0.28	0.66	750000	2000	Grid No. 1 Res., 33000 ohms			
1.25	- 4.5V	125	7	37	14000	8500	—	4500	1.5	12ED5
12.6	- 0.6V	12.6	2.8	.55	150000	800†	‡Between Grid No. 3 & Plate ‡Bias voltage across res. 2.2 megohms			12EG6
140	68 Ω	120	11□	47□	—	—	—	6000	3.8†	12EH5
12.6	—	12.6	1.7	4	50000	4200	Grid-No. 1 Supply Volts, 0 Grid-No. 1 Res. (Bypassed), 2.2 megohms			12EK6/ 12DZ6/ 12EA6
12.6	0V	—	—	0.75	45000	1200	55	—	—	12EL6

† For two tubes at stated plate-to-plate load.

□ For two tubes.

RCA Type	Name	Out-line	Terminal Dia-gram	Heater or Filament (F)		Use Values to right give operating conditions and characteristics for indicated typical use
				Volts	Amperes	
12EM6	Diode—Power Tetrode	6E	9HV	10.0 to 15.9	0.5 approx. at 12.6V	Class A Amplifier
12EN6	Beam Power Tube	13D	7AC	12.6	0.6	Vertical Deflection Amplifier
12EQ7	Diode—Remote-Cutoff Pentode	6E	9LQ	12.6	0.15	Pentode Unit as Class A Amplifier
12F5GT	High-Mu Triode	14A	5M	12.6	0.15	Amplifier
12F8	Twin Diode—Remote-Cutoff Pentode	6B	9FH	10.0 to 15.9	0.15 approx. at 12.6V	Pentode Unit as Class A Amplifier
12FK6	Twin Diode—Low-Mu Triode	5C	7BT	10.0 to 15.9	0.15 approx. at 12.6 V	Triode Unit as Class A Amplifier
12FM6	Twin Diode—Medium-Mu Triode	5C	7BT	10.0 to 15.9	0.15 approx. at 12.6V	Triode Unit as Class A Amplifier
12FQ8	High-Mu Twin Double-Plate Triode	6B	9KT	12.6	0.15	Each Unit as Class A Amplifier
12FR8	Diode—Medium-Mu Triode Remote-Cutoff Pentode	6K	9KU	12.6	0.32	Triode Unit as Class A Amplifier
12FV7	Medium-Mu Twin Triode	6E	9A	6.3 to 12.6	0.9 to 0.45	Each Unit as Class A Amplifier
12FX8	Medium-Mu Triode—Pentagrid Converter	6D	9KV	10.0 to 15.9	0.3 approx. at 12.6V	Triode Unit as Class A Amplifier Pentagrid Unit as Converter
12FX8A	Medium-Mu Triode-Pentagrid Converter	6D	9KV	10.0 to 15.9	0.27 approx. at 12.6V	Triode Unit as Class A Amplifier Pentagrid Unit as Converter
12GA6	Pentagrid Converter	5C	7CH	10.0 to 15.9	0.15 approx. at 12.6V	Converter
12GC6	Beam Power Tube	20A	8JX	12.6	0.6	Horizontal Deflection Amplifier
12GJ5	Beam Power Tube	18A	9QK	12.6	0.6	Horizontal Deflection Amplifier
12GN7 12GN7A	Sharp-Cutoff Pentode	6E	9BF	6.3 to 12.6	0.6 to 0.3	Class A Amplifier
12GT5 12GT5A	Beam Power Tube	17B	9NZ	12.6	0.6	Horizontal Deflection Amplifier
12H6	Twin Diode	29B	7Q	12.6	0.15	Voltage Doubler Half-Wave Rectifier
12J5GT	Medium-Mu Triode	13D	6Q	12.6	0.15	Amplifier
12J7GT	Sharp-Cutoff Pentode	14A	7R	12.6	0.15	Amplifier
12J8	Twin Diode—Power Tetrode	6B	9GC	10.0 to 15.9	0.325 approx. at 12.6V	Tetrode Unit as Class A Amplifier
12JB6	Beam Power Tube	18A	9QL	12.6	0.6	Horizontal-Deflection Amplifier
12JF5	Beam Power Tube	16A	12JH	12.6	0.6	Horizontal Deflection Amplifier
12JN8	Medium-Mu Triode—Sharp-Cutoff Pentode	6B	9FA	12.6	0.225	Triode Unit as Class A Amplifier Pentode Unit as Class A Amplifier
12JT6	Beam Power Tube	17C	9QU	12.6	0.6	Horizontal Deflection Amplifier
12K5	Power Tetrode	5D	7EK	10.0 to 15.9	0.4 approx. at 12.6V	Class A Amplifier
12K7GT	Remote-Cutoff Pentode	14A	7R	12.6	0.15	Amplifier
12K8	Triode-Hexode Converter	3	8K	12.6	0.15	Oscillator Mixer

Plate Volts	Grid Bias or Cathode Resistor	Screen Grid Volts	Screen Grid Cur- rent mA	Plate Cur- rent mA	AC Plate Resist- ance Ohms	Trans- conduc- tance Micromhos	Amplifi- cation Factor	Power		RCA Type
								Load Ohms	Out- put Watts	
12.6	—	12.6	1	6	4000	5000	Grid-No. 1 Res., 2.2 megohms		12EM6	
Max. Peak Pos.-Pulse Volts, 1200 Max. Peak Neg.-Pulse Grid Volts, 250 Max. Peak Cathode mA, 175							Max. Plate Dissipation, 7 watts Max. DC Plate Volts, 300		12EN6	
For other characteristics, refer to Type 6EQ7										12EQ7
For other characteristics, refer to Type 6F5GT										12F5GT
12.6	0V	12.6	0.38	1	330000	1000	Grid-No. 1 Volts for trans- cond. of 10 micromhos, —5		12F8	
12.6	Grid Supply Volts, 0 Grid Res. (Bypassed), 2.2 megohms			1.3	6200	1200	7.4	—	—	12FK6
12.6	0V	—	—	1	7700	1300	10	—	—	12FM6
250	—1.5V	—	—	1.5	76000	1250	95	—	—	12FQ8
With plate not in use connected to ground.										
12.6	—0.8V	12.6	0.7	1.9	400000	2700	—	—	—	12FR8
100	—2V	—	—	16	2250	9600	21.5	—	—	12FV7
12.6	—	—	—	1.3	7150	1400	10	Grid Res., 2.2 megohms		12FX8
12.6	—	12.6	1.25	0.29	500000	Grid No. 3 Res., 2.2 megohms Conversion Transcond., 300 μmhos		—	—	12FX8A
12.6	—0.8	—	—	1.3	7150	1400	10	—	—	12FX8A
12.6	—0.5	12.6	1.25	0.29	500000	Grid No. 3 Res., 2.2 megohms Conversion Transcond., 300 μmhos		—	—	12FX8A
12.6	1.6V	12.6	0.8	0.3	1 M	Grid No. 1 Res., 33000 ohms Conversion. Transcond., 140 μmhos		—	—	12GA6
Max. DC Plate Volts, 770 Max. DC Cathode mA, 175							Max. Peak Positive-Pulse Plate Volts, 6500 Max. Plate Dissipation 17.5 watts		12GC6	
For other characteristics, refer to Type 6GJ5										12GJ5
50 250	0V 0V	125 150	24 6.5	70 28	— 50000	— 36000	— —	— —	— —	12GN7 12GN7A
Max. DC Plate Volts, 770 Max. DC Cathode mA, 175							Max. Peak Positive-Pulse Plate Volts, 6500 Max. Plate Dissipation, 17.5 watts		12GT5 12GT5A	
Max. AC Supply Volts per Plate (RMS), 117 Min. Total Effect. Plate-Supply Imped. per Plate: half-wave, 30 ohms; full wave, 15 ohms Max. AC Plate Volts (RMS), 150 Max. DC Output mA, 8 per Plate							Max. DC Output mA, 8. min. Min. Total Effective Plate-Supply Impedance: up to 117 volts, 15 ohms; at 150 volts, 40 ohms		12H6	
For other characteristics, refer to Type 6J5GT										12J5GT
For other characteristics, refer to Type 6J7GT										12J7GT
12.6	—0V	12.6	1.5	12	6000	5500	—	2700	0.02	12J8
For other ratings, refer to Type 6JB6										12JB6
Max. DC Plate Volts, 770 Max. DC Cathode mA, 175							Max. Peak Positive-Pulse Plate Volts, 6500 Max. Plate Dissipation, 17.5 watts		12JF5	
125 125	—1V —1V	— 125	— 4	13.5 12	5400 200000	8500 7500	46 —	— —	— —	12JN8
Max. DC Plate Supply Volts, 770 Max. DC Cathode mA, 175							Max. Peak Positive-Pulse Plate Volts, 6500 Max. Plate Dissipation, 17.5 watts		12JT6	
DC Plate Volts, 12.6 Grid-No. 1 (Space-Charge Grid) DC Plate mA, 40		Grid-No. 2 (Control Grid) Volts, 12.6 Grid-No. 1 mA, 75		Grid-No. 2 (Control Grid) Volts, —.5 Amplification Factor, Grid-No. 2 to Plate, 7.2 Transcond., Grid-No. 2 to Plate, 15000 μmhos		Plate Resistance, 480 ohms				12K5
For other characteristics, refer to Type 6K7GT										12K7GT
For other characteristics, refer to Type 6K8										12K8

RCA Type	Name	Out-line	Terminal Diagram	Heater or Filament (F)		Use Values to right give operating conditions and characteristics for indicated typical use
				Volts	Amperes	
12KL8	Diode—Sharp-Cutoff Pentode	6E	9LQ	12.6	0.15	Pentode Unit as Class A Amplifier
12L6GT	Beam Power Tube	13D	7AC	12.6	0.6	Class A Amplifier
12Q7GT	Twin Diode—High-Mu Triode	14A	7V	12.6	0.15	Triode Unit as Amplifier
12R5	Beam Power Tube	5D	7CV	12.6	0.6	Vertical Deflection Amplifier
12S8GT	Triple Diode—High-Mu Triode	14B	8CB	12.6	0.15	Triode Unit as Class A Amplifier
12SA7 12SA7 GT	Pentagrid Converter	2A 13D	8R 8AD	12.6	0.15	Converter
12SC7	High-Mu Twin Triode	2A	8S	12.6	0.15	Each Unit as Class A Amplifier
12SF5 12SF5 GT	High-Mu Triode	2A 13D	8AB 8AB	12.6	0.15	Class A Amplifier
12SF7	Diode—Remote-Cutoff Pentode	2A	7AZ	12.6	0.15	Pentode Unit as Amplifier
12SG7	Semiremote-Cutoff Pentode	2A	8BK	12.6	0.15	Class A Amplifier
12SH7	Remote-Cutoff Pentode	3	8BK	12.6	0.15	Class A Amplifier
12SJ7 12SJ7 GT	Sharp-Cutoff Pentode	2A 13D	8N 8N	12.6	0.15	Class A Amplifier
12SK7 12SK7 GT	Remote-Cutoff Pentode	2A 13D	8N 8N	12.6	0.15	Class A Amplifier
12SN7 GT	Medium-Mu Twin Triode	13D	8BD	12.6	0.3	Each Unit as Class A Amplifier
12SQ7 12SQ7 GT	Twin Diode—High-Mu Triode	2A 13D	8Q 8Q	12.6	0.15	Triode Unit as Class A Amplifier
12SR7 12SR7 GT	Twin Diode—Medium-Mu Triode	2A 13D	8Q 8Q	12.6	0.15	Triode Unit as Class A Amplifier
12SW7♦	Twin Diode—Medium-Mu Triode	2A	8Q	12.6	0.15	Triode Unit as Class A Amplifier
12SY7♦	Pentagrid Converter	2A	8R	12.6	0.15	Converter
12U7	Medium-Mu Twin Triode	6B	7CK	10.0 to 15.9	0.15 approx. at 12.6V	Each Unit as Class A Amplifier
12Z3	Half-Wave Rectifier	22	4G	12.6	0.3	With Capacitive-Input Filter
13EM7	Dual Triode	13A	8BD	13	0.45	Unit No. 1 as Vertical Deflection Amplifier Unit No. 2 as Vertical Deflection Amplifier
13GB5	Beam Power Tube	10E	9NH	13.3	0.6	Horizontal Deflection Amplifier
13GF7	Dual Triode	11A	9QD	13	0.45	Vertical Deflection Amplifier Vertical Deflection Oscillator
13J10	Power Pentode Gated-Beam Discriminator	8B	12BT	13.2	0.45	Pentode Unit as Class A Amplifier Beam Unit as Gated-Beam Discriminator
13Z10	Power Pentode Gated-Beam Discriminator	8C	12BT	13.2	0.45	Class A Amplifier
14A4	Medium-Mu Triode	12B	5AC	12.6	0.15	Class A Amplifier
14A5	Beam Power Tube	12B	6AA	12.6	0.15	Class A Amplifier

♦ Industrial Type

Plate Volts	Grid Bias or Cathode Resistor	Screen Grid Volts	Screen Grid Cur- rent mA	Plate Cur- rent mA	AC Plate Resist- ance Ohms	Trans- conduct- ance Micromhos	Amplifi- cation Factor	Power		RCA Type
								Lead Ohms	Out- put Watts	
For other characteristics, see Type 6KL8										12KL8
110	— 7.5V	110	4.0	49	13000	8000	—	2000	2.1	12L6GT
200	180Ω	125	2.2	46	28000	8000	—	4000	3.8	12L6GT
For other characteristics, refer to Type 6Q7GT										12Q7GT
Max. DC Plate Volts, 150					Max. Peak Neg.-Pulse Grid-No. 1 Volts, 150					12R5
Max. Peak Cathode mA, 155					Max. Grid-No. 2 Volts, 150					
Max. Plate Dissipation, 4.5 watts					Max. Peak Positive-Pulse Plate Volts, 1500 (Abs.)					
250	— 2V	—	—	0.9	91000	1100	100	—	—	12S8GT
For other characteristics, refer to Type 6SA7										12SA7 GT
For other characteristics, refer to Type 6SC7										12SC7
For other characteristics, refer to Type 6SF5										12SF5 GT
For other characteristics, refer to Type 6SF7										12SF7
For other characteristics, refer to Type 6SG7										12SG7
For other characteristics, refer to Type 6SH7										12SH7
For other characteristics, refer to Type 6SJ7										12SJ7 GT
For other characteristics, refer to Type 6SK7										12SK7 GT
For other characteristics, refer to Type 6J5										12SN7 GT
For other characteristics, refer to Type 6SQ7										12SQ7 GT
For other characteristics, refer to Type 6SR7										12SR7 GT
250	—9V	—	—	9.5	8500	1900	16	—	—	12SW7 [♦]
250	Self excited	100	8.5	3.5	1M	450	—	Grid-No.1 resistor =	20000Ω	12SY7 [♦]
12.6	0V	—	—	1	12500	1600	20	—	—	12U7
Max. DC Output mA,55										12Z3
Max. DC Plate Volts, 330					Max. Plate Dissipation, 1.5 watts					13EM7
Max. DC Cathode mA, 22										
Max. DC Plate Volts, 330					Max. Peak Positive-Pulse Plate Volts, 1500					
Max. DC Cathode mA, 50					Max. Plate Dissipation, 10 watts					
For other ratings, refer to Type 6GB5										13GB5
For other ratings, refer to Type 6GF7										13GF7
250	— 8V	250	2.5	35	100000	6500	—	5000	4.2	13J10
Max. Supply Volts, 330					Max. Peak Positive Grid-No. 1 Volts, 60					13Z10
Max. Grid-No. 2 Volts, 110					Max. DC Cathode mA, 13					
For other characteristics, refer to Type 6Z10/6J10										13Z10
For other characteristics, refer to Type 6J5										14A4
250	—12.5V	250	5.5	32	70000	3000	—	7500	2.8	14A5

RCA Type	Name	Out- line	Terminal Dia- gram	Heater or Filament (F)		Use Values to right give operat- ing conditions and character- istics for indicated typical use
				Volts	Amperes	
14A7	Remote-Cutoff Pentode	12B	8V	12.6	0.15	Class A Amplifier
14AF7	Medium-Mu Twin-Triode	12B	8AC	12.6	0.15	Each Unit as Class A Amplifier
14B6	Twin Diode—High-Mu Triode	12B	8W	12.6	0.15	Triode Unit as Class A Amplifier
14B8	Pentagrid Converter	12B	8X	12.6	0.15	Converter
14C5	Beam Power Tube	12C	6AA	12.6	0.225	Class A Amplifier
14C7	Sharp-Cutoff Pentode	12B	8V	12.6	0.15	Class A Amplifier
14E6	Twin Diode—Medium-Mu Triode	12B	8W	12.6	0.15	Triode Unit as Class A Amplifier
14E7	Twin Diode—Remote-Cutoff Pentode	12B	8AE	12.6	0.15	Pentode Unit as Class A Amplifier
14F7	High-Mu Twin Triode	12B	8AC	12.6	0.15	Each Unit as Class A Amplifier
14F8	Medium-Mu Twin Triode	12A	8BW	12.6	0.15	Each Unit as Class A Amplifier
14GT8	Twin Diode High-Mu Triode	6B	9KR	14	0.15	Triode Unit as Class A Amplifier
14H7	Semiremote-Cutoff Pentode	12B	8V	12.6	0.15	Class A Amplifier
14J7	Triode-Heptode Converter	12B	8EL	12.6	0.15	Converter
14JG8	Twin Diode—High-Mu Triode	6B	9KR	14	0.15	Triode Unit as Class A Amplifier
14N7	Medium-Mu Twin Triode	12C	8AC	12.6	0.3	Each Unit as Class A Amplifier
14Q7	Pentagrid Converter	12B	8AL	12.6	0.15	Converter
14R7	Twin Diode—Remote-Cutoff Pentode	12B	8AE	12.6	0.15	Pentode Unit as Class A Amplifier
15	Sharp-Cutoff Pentode	24B	5F	2.0	0.22	Class A Amplifier
15BD11 15BD11A	Dual Triode— Sharp-Cutoff Pentode	8B	12DP	14.7	0.45	Dual Triode Unit as Class A Amplifier Pentode Unit as Class A Amplifier
15CW5	Power Pentode	6G	9CV	15	0.3	Vertical Deflection Amplifier Triode Unit as Class A Amplifier
15DQ8	High-Mu Triode Sharp-Cutoff Pentode	8E	9HX	15	0.3	Pentode Unit as Class A Amplifier
15FM7	Dual Triode	8C	12EJ	14.8	0.45	Vertical Deflection Oscillator and Amplifier
15HB6	Power Pentode	6G	9NW	14.7	0.3	Vertical Deflection Amplifier
15KY8	High-Mu Triode— Beam Power Tube	11C	9QT	15	0.45	Triode Unit as Oscillator Beam Power Unit as Amplifier
15LE8	Twin Pentode	6G	9QZ	15	0.8	Class A Amplifier Triode Unit as Class A Amplifier
16A8	High-Mu Triode— Power Pentode	6G	9EX	16	0.3	Pentode Unit as Class A Amplifier
16AQ3	Diode	7D	9CB	16.4	0.6	
16BX11	High-Mu Triode Medium-Mu Triode Sharp-Cutoff Pentode	8B	12CA	16	0.315	Triode Unit 1 as Class A Amplifier Triode Unit 2 as Class A Amplifier Pentode Unit as Class A Amplifier
16KA6	Beam Power Tube	39A	12GH	15.8	0.6	Horizontal Deflection Amplifier
17AB10 17AB10/ 17X10	Power Pentode Gated-Beam Discriminator	8C	12BT	16.8	0.45	Pentode Unit as Class A Amplifier Beam Unit Gated-Beam Discriminator
17AX4 GT	Half-Wave Rectifier	13D	4CG	16.8	0.45	Television Damper Service
17AY3	Half-Wave Rectifier	11D	9HP	16.8	0.45	Television Damper Service
17BB14	Beam Pentode	35B	9NH	16.8	0.45	Class A Amplifier

Plate Volts	Grid Bias or Cathode Resistor	Screen Grid Volts	Screen Grid Cur- rent mA	Plate Cur- rent mA	AC Plate Resist- ance Ohms	Trans- conduc- tance Micromhos	Amplifi- cation Factor	Power		RCA Type
								Load Ohms	Out- put Watts	
100	— 1V	100	4.0	13.0	120000	2300	—	—	—	14A7
250	— 3V	100	2.6	9.2	80000	2000	—	—	—	14AF7
For other characteristics, refer to Type 7AF7										14AF7
For other characteristics, refer to Type 6SQ7										14B6
For other characteristics, refer to Type 6A8										14B8
315	—13V	225	2.2	34.0	80000	3750	—	8500	5.5	14C5
For other characteristics, refer to Type 6SJ7										14C7
For other characteristics, refer to Type 6BF6										14E6
250	330Ω	100	1.6	7.5	700000	1300	—	—	—	14E7
For other characteristics, refer to Type 6SL7GT										14F7
250	500Ω	—	—	6.0	—	3300	48	—	—	14F8
250	—3V	—	—	0.7	72000	1000	72	—	—	14GT8
For other characteristics, refer to Type 7H7										14H7
For other characteristics, refer to Type 7J7										14J7
250	— 2V	—	—	2	41000	2200	90	—	—	14JG8
For other characteristics, refer to Type 6SN7GT										14N7
For other characteristics, refer to Type 6SA7										14Q7
For other characteristics, refer to Type 7R7										14R7
135	— 1.5V	67.5	0.3	1.85	800000	750	—	—	—	15
200	—	—	—	7	12400	5500	68	—	—	15BD11
200	220Ω	—	—	9.2	9400	4400	41	—	—	15BD11A
135	100	135	4	17	45000	10400	—	—	—	15CW5
For other ratings, refer to Type 6CW5										15CW5
200	— 1.7	—	—	3	—	4000	65	—	—	15DQ8
200	— 3.4	220	3	18	150000	10000	—	—	—	15FM7
For other characteristics, refer to Type 6FM7										15FM7
Max. DC Plate Volts, 350					Max. Plate Dissipation, 10 watts					15HB6
Max. Peak Positive-Pulse Plate Volts, 2500										15KY8
For other ratings, refer to Type 6KY8										15KY8
For other characteristics, refer to Type 6LEB										15LE8
100	0	—	—	3.5	—	2500	70	—	—	16A8
200	—16	200	7	35	20000	6400	—	—	—	16A8
Max. Supply Volts, 250					Max. Peak Negative-Pulse Plate Volts, — 6000					16AQ3
Max. DC Plate mA, 220					Max. Plate Dissipation, 5 watts					16AQ3
150	150Ω	—	—	11	6800	6200	42	—	—	16BX11
150	150Ω	—	—	7.6	8400	6800	57	—	—	16BX11
125	56Ω	125	3.8	12	100000	11300	—	—	—	16BX11
35	0V	125	9.2	20	Instantaneous Plate Knee characteristic					16BX11
For other characteristics, refer to Type 21KA6										16KA6
145	—6V	110	3	36	30000	8600	—	3000	2.4	17AB10
Max. Supply Volts, 330					Max. Peak Positive Grid No. 1 Volts, 60					17AB10/
Max. Grid No. 2 Volts, 330					Max. DC Cathode mA, 13					17X10
Max. Peak Inverse Plate Volts, 4400					Max. Peak Heater-Cathode Volts: { —4000 +300 DC component must not exceed 900 volts					17AX4
Max. Peak Plate mA, 750										GT
Max. DC Plate mA, 125					For other ratings, refer to Type 6AY3					17AY3
100	—7.7V	100	7	100	5300	14000	—	—	—	17BB14

RCA Type	Name	Out- line	Terminal Dia- gram	Heater or Filament (F)		Use Values to right give operat- ing conditions and character- istics for indicated typical use
				Volts	Amperes	
17BH3 17BH3A	Half-Wave Rectifier	11D	9HP	17	0.6	Television Damper Service
17BQ6GTB	Beam Power Tube	14D	6AM	16.8	0.45	Horizontal Deflection Amplifier
17BR3	Half-Wave Rectifier	7D	9CB	16.8	0.45	Television Damper Service
17BS3	Half-Wave Rectifier	11D	9HP	16.8	0.45	Television Damper Service
17BZ3	Half-Wave Rectifier	8D	12FX	16.8	0.45	Television Damper Service
17CK3	Half-Wave Rectifier	30B	9HP	16.8	0.45	Television Damper Service
17D4	Half-Wave Rectifier	13D	4CG	16.8	0.45	Television Damper Service
17DM4	Half-Wave Rectifier	13G	4CG	16.8	0.45	Television Damper Service
17DQ6A	Beam Power Tube	20	6AM	16.8	0.45	Horizontal Deflection Amplifier
17DW4A	Half-Wave Rectifier	11D	9HP	16.8	0.45	Television Damper Service
17EW8	High-Mu Twin Triode	6B	9AJ	17.5	0.15	Each Unit as Class A Amplifier
17GJ5	Novar-Beam Power Tube	18A	9QK	16.8	0.45	Horizontal Deflection Amplifier
17GT5	Beam Power Tube	17B	9NZ	16.8	0.45	Horizontal Deflection Amplifier
17H3	Half-Wave Rectifier	6E	9FK	17.5	0.3	Television Damper Service
17HB25	Beam Pentode	35	17HB25	16.8	0.45	Horizontal Deflection Amplifier
17JB6	Beam Power Tube	18A	9QL	16.8	0.45	Horizontal Deflection Amplifier
17JG6	Beam Power Tube	17B	9QU	16.8	0.6	Horizontal Deflection Amplifier
17JT6	Beam Power Tube	17C	9QU	16.8	0.45	Horizontal Deflection Amplifier
17KV6	Beam Power Tube	31D	9QU	16.8	0.6	High-Voltage-Pulse Shunt Regulator
17LD8	Medium-Mu Triode—Sharp-Cutoff Pentode	10F	9QT	16.8	0.45	Triode Unit as Class A Amplifier Pentode Unit as Class A Amplifier
17X10	Pentode—Beam Power Tube	8C	12BT	16.8	0.45	Beam Power Unit as Class A Amplifier
17Z3/ PY81	Half-Wave Rectifier	7H	9CB	17	0.3	Television Damper Service
18A5	Beam Power Tube	13F	6CK	18.5	0.3	Horizontal Deflection Amplifier
18AJ10	Beam Power Tube Sharp-Cutoff Pentode	8C	12EZ	18	0.315	Beam Unit as Class A Amplifier Pentode Unit as FM Detector
18FW6 18FW6A	Remote-Cutoff Pentode	5C	7CC	18.0	0.1	Class A Amplifier
18FX6 18FX6A	Pentagrid Converter	5C	7CH	18.0	0.1	Converter
18FY6 18FY6A	Twin Diode—High-Mu Triode	5C	7BT	18.0	0.1	Triode Unit as Class A Amplifier
18GB5	Beam Power Tube	35B	9NH	18	0.45	Horizontal Deflection Amplifier
18GD6A	Sharp-Cutoff Pentode	5C	7BK	18	0.1	Class A Amplifier
19	High-Mu Twin Power Triode	22 or 13H	6C	2.0F	0.26	Amplifier
19AU4 19AU4 GTA	Half-Wave Rectifier	13G	4CG	18.9	0.6	Television Damper Service
19BG6G 19BG6 GA	Beam Power Tube	27B	5BT	18.9	0.3	Horizontal Deflection Amplifier

Plate Volts	Grid Bias or Cathode Resistor	Screen Grid Volts	Screen Grid Cur- rent mA	Plate Cur- rent mA	AC Plate Resist- ance Ohms	Trans- conduc- tance Micromhos	Amplifi- cation Factor	Power		RCA Type	
								Load Ohms	Out- put Watts		
For other ratings, refer to Type 6BH3										17BH3	
For other characteristics, refer to Type 6BQ6GTB/6CU6										17BH3A	
For other ratings, refer to Type 6BS3										17BQ6GTB	
Max. Peak Inverse Plate Volts, 5500		Max. DC Plate mA, 200		Max. Peak Heater		Cathode Volts: $\left\{ \begin{array}{l} +300 \\ -5500 \end{array} \right.$				17BR3	
Max. Peak Plate mA, 1200		Max. Plate Dissipation, 6.5 watts									17BS3
For other ratings, refer to Type 6BZ3										17BZ3	
Max. Peak Inverse Plate Volts, 4500		Max. Plate Dissipation, 6.5 watts		Max. Peak Heater Cathode Volts: $\left\{ \begin{array}{l} -4500 \\ +900 \end{array} \right.$							17CK3
Max. Peak Plate mA, 1200											17D4
For other characteristics, refer to Type 6CK3										17D4	
For other ratings, refer to Type 12D4										17DM4	
For other ratings, refer to Type 6DM4										17DM4	
Max. DC Plate Volts, 700		Max. DC Cathode mA, 140		Max. Peak Positive-Pulse Plate Volts, 6000 (Abs.)		Max. Plate Dissipation, 15 watts				17DQ6A	
For other characteristics, refer to Type 6DW4A										17DW4A	
100	— 1.1V	—	—	10	—	4600	50	—	—	17EW8	
200	— 2.1V	—	—	4.5	—	5800	48	—	—	17EW8	
For other ratings, refer to Type 6GJ5										17GJ5	
For other ratings, refer to Type 6GT5										17GT5	
Max. Peak Inverse Plate Volts, 2000		Max. Average Plate mA, 75		Max. Plate Dissipation, 3 watts							17H3
Max. Peak Plate mA, 450											17HB25
Max. Peak Positive-Pulse Plate Volts, 7000		Max. Average Cathode mA, 150		Max. Plate Dissipation, 13 Watts							17HB25
For other ratings, refer to Type 6JB6										17JB6	
For other characteristics, refer to Type 17JG6A										17JG6	
For other ratings, refer to Type 6JT6										17JT6	
For other characteristics, refer to Type 6KV6A										17KW6	
150	— 5V	—	—	3.3	11300	1900	21.5	—	—	17LD8	
120	— 8V	110	4	46	11700	7100	—	—	—	17LD8	
145	— 6V	110	3	36	30000	8600	—	3000	—	17X10	
Max. Peak Inverse Plate Volts, 5000		Max. Average Plate mA, 150		Max. Heater-Cathode Volts, +220, -4500							17Z3/ PY81
Max. Peak Plate mA, 450											18A5
Max. DC Plate Volts, 350		Max. Peak Pos.-Pulse Plate Volts 3000		Max. Plate Dissipation, 9 watts							18A5
Max. DC Cathode mA, 90											18A5
145	—7V	110	6.5	34	33000	5600	—	2500	1.45	18AJ10	
150	180Ω	100	3.5	2.8	180000	2400	Grid No. 3 Volts, 0		—	18AJ10	
100	68Ω	100	4.4	11	250000	4400	—				18FW6 18FW6A
100	— 1.5V	100	6.2	2.3	400000	Grid No. 1 Resistor, 20000 ohms Conversion Transcond., 480 μmhos				18FX6 18FX6A	
100	— 1V	—	—	0.6	77000	1300	100	—			18FY6 18FY6A
For other characteristics, refer to Type 6GB5/EL500										18GB5	
100	150Ω	100	2	5	500000	4300	—				18GD6A
For other ratings, refer to Type 1J6GT										19	
For other ratings, refer to Type 6AU4GTA										19AU4 19AU4 GTA	
Max. DC Plate Volts, 700		Max. Peak Positive-Pulse Plate Volts, 6600 (Abs.)		Max. Plate Dissipation, 20 watts							19BG6G
Max. DC Plate Current, 110 mA.											19BG6 GA

RCA Type	Name	Out- line	Terminal Dia- gram	Heater or Filament (F)		Use Values to right give operat- ing conditions and character- istics for indicated typical use
				Volts	Amperes	
19CL8A	Medium-Mu Triode— Sharp-Cutoff Tetrode	6B	9FX	18.9	0.15	Triode Unit as Class A Amplifier Tetrode Unit as Class A Amplifier Pentode Unit as
19DE3	Half-Wave Rectifier	9D	12HX	19	0.6	Television Damper Service
19EZ8	High-Mu Triple Triode	6B	9XA	18.9	0.15	Each Unit as Class A Amplifier
19GQ7	Triple Diode	6B	9QM	18.9	0.15	Each Unit as Half-Wave Rectifier
19HR6	Semiremote-Cutoff Pentode	5C	7BK	18.9	0.15	Class A Amplifier
19HS6	Sharp-Cutoff Pentode	5C	7BK	18.4	0.15	Class A Amplifier
19HV8	High-Mu Triode Sharp-Cutoff Pentode	6B	9FA	18.9	0.15	Triode Unit as Class A Amplifier Pentode Unit as Class A Amplifier
19J6	Medium-Mu Twin Triode	5C	7BF	18.9	0.15	Each Unit as Class A Amplifier
19JN8	Medium-Mu Triode— Sharp-Cutoff Pentode	6B	9FA	18.9	0.15	Triode Unit as Class A Amplifier Pentode Unit as Class A Amplifier
19KG8	Medium-Mu Triode Sharp-Cutoff Pentode	6B	9LY	18.9	0.15	Triode Unit as Class A Amplifier Pentode Unit as Class A Amplifier
19Q9	Medium-Mu Triode— Semiremote-Cutoff Pentode	6B	10H	18.9	0.15	Triode Unit as Class A Amplifier Pentode Unit as Class A Amplifier
19X8	Medium-Mu Triode— Sharp-Cutoff Pentode	6B	9AK	18.4	0.15	Triode Unit as Class A Amplifier Pentode Unit as Class A Amplifier
20	Power Triode		4D	3.3F	0.132	Class A Amplifier
20EQ7	Diode—Remote-Cutoff Pentode	6E	9LQ	20.0	0.1	Pentode Unit as Class A Amplifier
20EZ7	High-Mu Twin Triode	6B	9PG	20	0.1	Each Unit as Class A Amplifier
21EX6	Beam Power Tube	21B	5BT	21.5	0.6	Horizontal Deflection Amplifier
21HB5	Beam Power Tube	15B	12BJ	21	0.45	Horizontal Deflection Amplifier
21HJ5	Beam Power Tube	15C	12FL	21.5	0.6	Horizontal Deflection Amplifier
21JV6	Beam Power Tube	15B	12FK	21	0.45	Horizontal Deflection Amplifier
21LG6	Beam Power Tube	16B	12HL	21	0.6	Horizontal Deflection Amplifier
21MY8	High-Mu Triode Beam Power Tube	15D	12DZ	21	0.45	Triode Unit as Class A Amplifier Beam Unit as Class A Amplifier
22	Sharp-Cutoff Tetrode	29K	4K	3.3F	0.132	Screen-Grid RF Amplifier
22BH3 22BH3A	Half-Wave Rectifier	11D	9HP	22.4	0.45	Television Damper Service
22JG6	Beam Power Tube	17B	9QU	22	0.45	Horizontal Deflection Amplifier
24A	Sharp-Cutoff Tetrode	29K	5E	2.5	1.75	Screen-Grid RF Amplifier
24JE6A	Beam Power Tube	32B	9QL	24	0.6	Horizontal Deflection Amplifier
24LZ6	Beam Power Tube	32C	9QL	24	0.6	Horizontal Deflection Amplifier
25A6 25A6GT	Power Pentode	2B 13D	7S 7S	25.0	0.3	Class A Amplifier
25A7GT	Rectifier—Power Pentode	13D	8F	25.0	0.3	Pentode Unit as Class A Amplifier Half-Wave Rectifier
25AC5 GT	High-Mu Power Triode	13D	6Q	25.0	0.3	Amplifier

Plate Volts	Grid Bias or Cathode Resistor	Screen Grid Volts	Screen Grid Cur- rent mA	Plate Cur- rent mA	AC Plate Resist- ance Ohms	Trans- conduct- ance Micromhos	Amplifi- cation Factor	Power		RCA Type
								Load Ohms	Out- put Watts	
125	-1	—	—	14	5000	8000	40	—	—	19CL8A
125	-1	125	4	12	200000	6500	—	—	—	
Max. Peak Inverse Plate Volts, 5000				Max. Average Plate mA, 350				Max. Heater-Cathode Volts, +300, -5000		19DE3
Max. Peak Plate mA, 1050										19EZ8
For other characteristics, refer to Type 6E28										19GQ7
For other characteristics, refer to Type 6GQ7										19HR6
For other characteristics, refer to Type 6HR6										19HS6
75	0V	75	—	—	—	—	50	—	—	19HY8
150	0V	75	2.8	8.8	500000	9500	—	—	—	
100	-1V	—	—	0.8	54000	1300	70	—	—	19J6
125	-1V	125	4	12	200000	6500	—	—	—	
100	50Ω (For both units at the specified conditions)			8.5	7100	5300	38	—	—	19JN8
125	-1	—	—	13.5	5400	8500	46	—	—	
125	-1	125	4	12	200000	7500	—	—	—	19KG8
125	-1V	—	—	13.5	5400	8500	46	—	—	
125	-1V	125	4	12	200000	7500	—	—	—	
125	-1V	—	—	14	5000	8000	40	—	—	19Q9
125	-1V	125	4	12	200000	6500	—	—	—	
For other characteristics, refer to Type 6X8										19X8
135	-22.5V	—	—	6.5	6300	525	3.3	6500	0.110	20
For other characteristics, refer to Type 6EQ7										20EQ7
250	-2V	—	—	1.2	62500	1600	100	—	—	20EZ7
For other ratings, refer to Type 6EX6										21EX6
Max. DC Plate Supply Volts, 770				Max. DC Cathode mA, 230				Max. Plate Dissipation, 18 watts		21HB5
Max. Peak Positive-Pulse Plate Volts, 6000				Max. Plate Dissipation, 18 watts						21HJ5
Max. DC Plate Supply Volts, 770				Max. DC Cathode mA, 280				Max. Plate Dissipation, 24 watts		21JV6
Max. Peak Positive-Pulse Plate Volts, 7000				Max. Plate Dissipation, 28 Watts				Max. Peak Positive-Pulse Plate Volts, 7500		21LG6
Max. DC Plate Supply Volts, 770				Max. DC Cathode mA, 230				Max. Plate Dissipation, 18 watts		21MY8
Max. Peak Positive Pulse Plate Volts, 6000				Max. Plate Dissipation, 28 Watts				Max. Peak Positive-Pulse Plate Volts, 7500		22
Max. DC Plate Volts, 900				Max. Plate Dissipation, 28 Watts				Max. Peak Positive-Pulse Plate Volts, 7500		22BH3
Max. Average Cathode mA, 315				Max. Plate Dissipation, 28 Watts				Max. Peak Positive-Pulse Plate Volts, 7500		22BH3A
250	-4V	—	—	2.3	16000	3600	58	—	—	22JG6
135	-10	120	3	56	12000	9300	—	—	—	24A
45	0V	125	20	200	Instantaneous Plate Knee characteristic					
135	-1.5V	67.5	1.3 (Max.)	3.7	325000	500	—	—	—	24JG6
For other ratings, refer to Type 6B3										24LZ6
For other characteristics, refer to Type 22JG6A										25A6
250	-3V	90	1.7 (Max.)	4.0	600000	1050	—	—	—	25A6GT
Max. DC Plate Volts, 990				Max. Peak Positive-Pulse Plate Volts, 7500				Max. Plate Dissipation, 30 Watts		25A7
Max. Average Cathode mA, 350				Max. Plate Dissipation, 30 Watts						GT
For other characteristics, refer to Type 31LZ6										25AC5
95	-15V	95	4	20	45000	2000	—	4500	0.9	GT
100	-15V	100	4.0	20.5	50000	1800	—	4500	0.77	GT
Max. AC Plate Volts (RMS), 117				Max. DC Output mA, 75			Max. Peak Plate mA, 450			25AC5
110	+15V (Grid mA, 7)			15	15200	3800	58	—	—	GT

RCA Type	Name	Out-line	Terminal Dia-gram	Heater or Filament (F)		Use Values to right give operating conditions and characteristics for indicated typical use
				Volts	Amperes	
25AX4 GT	Half-Wave Rectifier	13D	4CG	25	0.3	Television Damper Service
25B5	Direct-Coupled Power Amplifier	—	6D	25.0	0.3	Amplifier
25B6G	Power Pentode	25	7S	25.0	0.3	Class A Amplifier
25B8GT	High-Mu Triode—Remote-Cutoff Pentode	13D	8T	25.0	0.15	Triode Unit as Class A Amplifier Pentode Unit as Class A Amplifier
25BK5	Beam Power Tube	6E	9BQ	25	0.3	Class A Amplifier
25BQ6 GT	Beam Power Tube	14D	6AM	25.0	0.3	Horizontal Deflection Amplifier
25C6G	Beam Power Tube	25	7AC	25.0	0.3	Class A Amplifier
25CA5	Beam Power Tube	5D	7CV	25	0.3	Class A Amplifier
25CD6 GA	Beam Power Tube	21B	5BT	25	0.6	Horizontal Deflection Amplifier
25CK3	Half-Wave Rectifier	30B	9HP	25.2	0.3	Television Damper Service
25CM3	Half-Wave Rectifier	30B	9HP	25	0.6	Television Damper Service
25DN6	Beam Power Tube	21	5BT	25	0.6	Horizontal Deflection Amplifier
25E5/ PL36	Beam Power Tube	14K	8GT	25	0.3	Horizontal Deflection Amplifier
25EC6	Beam Power Tube	21A	5BT	25.0	0.6	Horizontal Deflection Amplifier
25F5A	Beam Power Tube	5D	7CV	25	0.15	Class A Amplifier
25HX5	Beam Power Tube	10F	9SB	25	0.3	Vertical Deflection Amplifier
25JQ6	Beam Power Tube with Integral Diode	6G	9RA	25.2	0.3	Vertical Deflection Amplifier
25L6	Beam Power Tube	2B	7AC	25.0	0.3	Amplifier
25L6GT 25L6GT/ 25W6GT	Beam Power Tube	13D	7AC	25.0	0.3	Amplifier
25N6G	Direct-Coupled Power Amplifier	—	7W	25.0	0.3	Class A Amplifier
25W4GT	Half-Wave Rectifier	13D	4CG	25.0	0.3	Television Damper Service
25W6GT	Beam Power Tube	13D	7AC	25	0.3	Class A Amplifier
25Y5	Rectifier-Doubler	22 or 13H	6E	25.0	0.3	Half-Wave Rectifier
25Z5	Rectifier-Doubler	22 or 13H	6E	25.0	0.3	Rectifier-Doubler
25Z6 25Z6GT	Rectifier-Doubler	2B 13D	7Q 7Q	25.0 25.0	0.3 0.3	Voltage Doubler Half-Wave Rectifier
26	Medium-Mu Triode	26	4D	1.5F	1.05	Class A Amplifier
26A6♦	Remote-Cutoff Pentode	5C	7BK	26.5	0.07	Class A Amplifier
26A7GT♦	Twin Power Pentode	13G	8BU	26.5	0.6	Class A Amplifier
26C6♦	Twin Diode—Medium-Mu Triode	5C	7BT	26.5	0.07	Triode Unit as Class A Amplifier
26D6♦	Pentagrid Converter	5C	7CH	26.5	0.07	Converter
26LW6	Beam Power Tube	29N	8NC	26	0.6	Horizontal Deflection Amplifier

♦ Industrial Type

Plate Volts	Grid Bias or Cathode Resistor	Screen Grid Volts	Screen Grid Cur- rent mA	Plate Cur- rent mA	AC Plate Resist- ance Ohms	Trans- conduc- tance Micromhos	Amplifi- cation Factor	Power		RCA Type
								Ohms	Out- put Watts	
For other characteristics, refer to Type 6AX4GTB										25AX4 GT
For other characteristics, refer to Type 25N6G										25B5
200	-23V	135	1.8	62.0	18000	5000	—	2500	7.1	25B6G
100	-1V	—	—	0.6	75000	1500	112	—	—	—
100	-3V	100	2.0	7.6	185000	2000	—	—	—	25B8GT
For other characteristics, refer to Type 6BK5										25BK5
Max. DC Plate Volts, 600					Absolute Max. Peak Positive-Pulse Plate Volts, 6000 (Abs.)					25BQ6
Max. DC Cathode mA, 112.5					Max. Plate Dissipation, 11 Watts					GT
For other characteristics, refer to Type 6Y6G										25C6G
110	-4V	110	3.5	32	16000	8100	—	3500	1.1	25CA5
125	-4.5V	125	4	37	15000	9200	—	4500	1.5	—
Max. DC Plate Volts, 700					Max. Peak Positive-Pulse Plate Volts, 7000					25CD6
Max. DC Plate mA, 200					Max. Plate Dissipation, 20 Watts					GA
For other characteristics, refer to Type 6CK3										25CK3
For other characteristics, refer to Type 6CM3										25CM3
For other characteristics, refer to Type 6DN6										25DN6
Max. DC Plate Supply Volts, 550					Max. DC Cathode mA, 200					25E5/
Max. Peak Positive Pulse Plate Volts, 7000					Max. Plate Dissipation, 10 watts					PL36
Max. DC Plate Volts, 700					Max. Peak Positive-Pulse Plate Volts, 700 (Abs.)					25EC6
Max. DC Cathode mA, 200					Max. Plate Dissipation 10 watts.					—
110	-7.5V	110	3.8	43	13000	6400	—	2500	1.5	25F5A
100	-8.2V	100	7	100	5000	14000	—	—	—	25HX5
40	0V	100	19	240	Instantaneous Plate Knee characteristic					—
For other characteristics, refer to Type 6JQ6										25JQ6
110	-7.5V	110	4	49	13000	9000	—	2000	2.1	25L6
200	-8V	110	2	50	30000	9500	—	3000	4.3	—
For other characteristics, refer to Type 50L6GT										25L6GT/ 25W6GT
Output Triode: Plate Volts, 180; Plate mA, 46; Load, 4000 ohms									3.8	25N6G
Triode: Plate Volts, 100; Grid Volts, 0; A-F Signal Volts (Peak), 29.7; Plate mA, 5.8									—	—
Max. Peak Inverse Plate Volts, 3850 (Abs.)					Max. Peak Heater-Cathode Volts: { -500 (Abs.)					25W4GT
Max. Peak Plate mA, 750					+200					—
Max. DC Plate mA, 125					DC Component must not exceed 100 volts					—
225	-30	—	—	22	1600	3800	6.2	—	—	25W6GT
Max. DC Output mA per Plate, 75										25Y5
For other ratings, refer to Type 25Z6										25Z5
Max. AC Volts per Plate (RMS), 117					Min. Total Effective Plate-Supply Impedance: Half-					25Z6
Max. DC Output mA, 75					Wave, 30 ohms; Full-Wave, 15 ohms					—
Max. AC Volts per Plate (RMS), 235					Min. Total Effect. Supply Imped. per Plate: at 117 volts					25Z6GT
Max. DC Output mA per Plate, 75					15 ohms; at 150 volts, 40 ohms; at 235 volts, 100 ohms					—
180	-14.5V	—	—	6.2	7300	1150	8.3	—	—	26
250	125Ω	100	4.0	10.5	1M	4000	—	—	—	26A6*
26.5	-4.5V	26.5	1.9	20	{each unit}	5700	—	1500	180mW	26A7GT*
250	-9V	—	—	9.5	8500	1900	16	—	—	26C6*
250	Self excited	100	7.8	3.0	1M	475	Grid-No.1 resistor = 20000Ω	—	—	26D6*
Max. Peak Positive Pulse Plate Volts, 7500					Max. DC Cathode mA, 400					26LW6
Max. Peak Cathode mA, 1400					Max. Plate Dissipation, 40 watts					—

RCA Type	Name	Out- line	Terminal Dia- gram	Heater or Filament (F)		Use Values to right give operat- ing conditions and character- istics for indicated typical use
				Volts	Amperes	
27	Low-Mu Triode	22 or 13H	5A	2.5	1.75	Class A Amplifier
29KQ6/ PL521	Beam Power Tube	35A	9RJ	29	0.3	Horizontal Deflection Amplifier
30	Medium-Mu Triode	22 or 13H	4D	2.0F	0.06	Amplifier
30JZ6	Beam Power Tube	39A	12GD	30	0.3	Horizontal Deflection Amplifier
30AG11	Twin Diode—Twin-Triode	6A	12DA	30	0.15	Each Triode as Class A Amplifier
30MB6	Beam Power Tube	16H	12FY	30	0.45	Horizontal Deflection Amplifier
31	Power Triode	22 or 13H	4D	2.0F	0.13	Class A Amplifier
31AL10	Dual Medium-Mu Triode Beam Power Tube	8C	12HR	31.5	0.315	Triode No. 1 as Class A Amplifier Triode No. 2 as Class A Amplifier Beam Unit as Class A Amplifier
31JS6A	Beam Power Tube	16B	12FY	31.5	0.45	Horizontal Deflection Amplifier
32	Sharp-Cutoff Tetrode	29K	4K	2.0F	0.06	Class A Amplifier
32E75 32E75A	Power Pentode	5D	7CV	32.0	0.1	Class A Amplifier
32HQ7	Damper Diode Beam Power Tube	15A	12HT	32.6	0.315	Diode Unit as Television Damper Service Beam Unit as Horizontal Deflection Amplifier
32L7GT	Rectifier—Beam Power Tube	14A	8Z	32.5	0.3	Class A Amplifier Half-Wave Rectifier
33	Power Pentode	25	5K	2.0F	0.26	Class A Amplifier
33GT7	Damper Diode Beam Power Tube	15A	12FC	33.6	0.45	Diode Unit as Television Damper Service Beam Unit as Horizontal Deflection Amplifier
33GY7	Diode—Beam Power Tube	15A	12FN	33.6	0.45	Diode Unit as Television Damper Service Beam Power Unit as Horizontal Deflection Amplifier
33JV6	Beam Power Tube	15B	12FK	33	0.3	Horizontal Deflection Amplifier
34	Remote-Cutoff Pentode	29K	4M	2.0F	0.06	Screen-Grid RF Amplifier
34CM3	Half-Wave Rectifier	30B	9HP	33.5	0.45	Television Damper Service
34GD5 34GD5A	Beam Power Tube	5D	7CV	34.0	0.1	Class A Amplifier
34R3	Half-Wave Rectifier	7C	9CB	34	0.15	Television Damper Service
35	Remote-Cutoff Tetrode	29K	5E	2.5	1.75	Screen-Grid RF Amplifier
35A5	Beam Power Tube	12C	6AA	35.0	0.15	Single-Tube Class A Amplifier
35B5	Beam Power Tube	5D	7BZ	35.0	0.15	Class A Amplifier
35DZ8	High-Mu Triode—Power Pentode	6H	9JE	35.0	0.15	Triode Unit as Class A Amplifier Pentode Unit as Class A Amplifier
35EH5	Power Pentode	5D	7CV	35	0.15	Class A Amplifier
35GL6	Beam Power Tube	5D	7FZ	35.0	0.15	Class A Amplifier
35L6GT	Beam Power Tube	13D	7AC	35	0.15	Class A Amplifier

Plate	Grid Bias or Cathode Resistor	Screen Grid	Screen Grid Cur- rent	Plate Cur- rent	AC Plate Resist- ance	Trans- conduct- ance	Amplifi- cation Factor	Power		RCA Type
								Lead	Out- put	
Volts		Volts	mA	mA	Ohms	Micromhos		Ohms	Watts	
250	-21V	—	—	5.2	9250	975	9.0	—	—	27
Max. DC Plate Volts, 275							Max. Plate Dissipation, 17 watts		29K06/ PL521	
Max. Peak Positive Pulse Plate Volts, 6500							Max. DC Cathode mA, 275			
For other characteristics, refer to Type 1H4G										30
For other characteristics, refer to Type 6JZ6										30JZ6
For other characteristics, refer to Type 6AG11										30AG11
Max. DC Plate Volts, 990							Max. Plate Dissipation, 38 watts		30MB6	
Max. Peak Positive Pulse Plate Volts, 8000							Max. DC Cathode mA, 400			
180	-30V	—	—	12.3	3600	1050	3.8	5700	0.375	31
150	-2V	—	—	5.4	11000	3900	—	—	—	31AL10
150	-5V	—	—	5.5	8500	2350	—	—	—	
120 40	-8V 0	110 110	3.5 16.5	46 122	11700	7100	Instantaneous Plate Knee characteristic			
For other characteristics, refer to Type 6J56A										31J56A
180 (Max.)	-3V	67.5	0.4	1.7	1 M	650	—	—	—	32
110	-7.5V	110	2.8	30	21500	5500	—	2800	1.2	32ET5 32ET5A
Max. Peak Inverse Plate Volts, 3300							Max. Plate Dissipation, 3.8 watts		32HQ7	
Max. Peak Plate mA, 600							Max. Peak Heater-Cathode Volts, +200, -3300			
Max. DC Plate Supply Volts, 400							Max. DC Cathode mA, 125			
Max. Peak Positive-Pulse Plate Volts, 4000							Max. Plate Dissipation, 7 watts			
90	-7V	90	2.0	27.0	17000	4800	—	2600	1.0	32L7GT
Maximum AC Plate Voltage.....						125 Volts, RMS				
Maximum DC Output Current.....						60 Milliamperes				
180	-18V	180	5.0	22.0	55000	1750	—	6000	1.4	33
Max. Peak Inverse Plate Volts, 2500							Max. Plate Dissipation, 3.5 watts		33GT7	
Max. Peak Plate mA, 750							Max. Peak Heater-Cathode Volts, +200, -2500			
Max. DC Plate Supply Volts, 400							Max. DC Cathode mA, 140			
Max. Peak Positive Plate Volts, 3500							Max. Plate Dissipation, 9 watts			
Max. Peak Inverse Plate Volts, 4200							Max. Plate Dissipation, 3.8 watts			
Max. Peak Plate mA, 810							Max. Peak Heater-Cathode Volts:		-4200 +200	
Max. DC Plate Supply Volts, 400							Max. DC Cathode mA, 155		33GY7	
Max. Peak Positive-Pulse Plate Volts, 5000							Max. Plate Dissipation, 9 watts			
For other characteristics, refer to Type 21JV6										33JV6
180	-3V min.	67.5	1.0	2.8	1 M	620	—	—	—	34
For other characteristics, refer to Type 6CM3										34CM3
110	-7.5V	110	3	35	13000	5700	—	2500	1.4	34GD5 34GD5A
Max. Peak Inverse Plate Volts, 4500							Max. DC Cathode mA, 150		34R3	
Max. Peak Plate mA, 450										
250	-3V min.	90	2.5	6.5	—	1050	—	—	—	35
For other characteristics, refer to Type 35L6GT										35A5
For other characteristics, refer to Type 35C5										35B5
120	1500Ω	—	—	0.8	—	1400	100	—	—	35DZ8
140	180Ω	120	6	45	—	7500	—	2500	2.0	
110	62Ω	115	7.2	32	14000	3000	—	3000	1.2	35EH5
110	-7.5V	110	3	45	12000	7500	—	2500	1.8	35GL6
200	180Ω	125	2	43	34000	6100	—	5000	3	35L6GT
110	-7.5V	110	3	40	14000	5800	—	2500	1.5	

RCA Type	Name	Out- line	Terminal Dia- gram	Heater or Filament (F)		Use Values to right give operat- ing conditions and character- istics for indicated typical use
				Volts	Amperes	
35Y4	Half-Wave Rectifier Heater Tap for Pilot	12C	5AL Pilot Between Pins 1 and 4	35.0	0.15	With Capacitive-Input Filter
35Z3	Half-Wave Rectifier	12C	4Z	35.0	0.15	With Capacitive-Input Filter
35Z4GT	Half-Wave Rectifier	13D	5AA	35.0	0.15	With Capacitive-Input Filter
36	Sharp-Cutoff Tetrode	24B	5E	6.3	0.3	Screen-Grid RF Amplifier
36AM3	Half-Wave Rectifier	5D	5BQ	36.0	0.1	With Capacitive-Input Filter
36AM3A 36AM3B	Half-Wave Rectifier	5D	5BQ	36.0	0.1	With Capacitive-Input Filter
37	Medium-Mu Triode	22 or 13H	5A	6.3	0.3	Class A Amplifier
38	Power Pentode	24B	5F	6.3	0.3	Class A Amplifier
39/44	Remote-Cutoff Pentode	24B	5F	6.3	0.3	Class A Amplifier
40	Medium-Mu Triode	26	4D	5.0F	0.25	Class A Amplifier
40KD6	Beam Power Tube	16C	12GW	40	0.45	Horizontal Deflection Amplifier
41	Power Pentode	22 or 13H	6B	6.3	0.4	Amplifier
42	Power Pentode	28	6B	6.3	0.7	Amplifier
42EC4A/ PY500	Half-Wave Rectifier	35C	6EC4	42	0.3	Television Damper Service
43	Power Pentode	26	6B	25.0	0.3	Amplifier
45	Power Triode	26	4D	2.5F	1.5	Class A Amplifier
45Z3	Half-Wave Rectifier	5C	5AM	45.0	0.075	Half-Wave Rectifier
45Z5GT	Half-Wave Rectifier Heater Tap for Pilot	13D	6AD Pilot Between Pins 2 and 3	45.0	0.15	With Capacitive-Input Filter
46	Dual-Grid Power Amplifier	27B	5C	2.5F	1.75	Class A Amplifier
47	Power Pentode	27B	5B	2.5F	1.75	Class A Amplifier
48	Power Tetrode	27B	6A	30.0	0.4	Class A Amplifier
49	Dual-Grid Power Amplifier	26	5C	2.0F	0.12	Class A Amplifier
50	Power Triode	29L	4D	7.5F	1.25	Class A Amplifier
50A5	Beam Power Tube	12C	6AA	50.0	0.15	Class A Amplifier
50B5	Beam Power Tube	5D	7BZ	50	0.15	Class A Amplifier
50C6G	Beam Power Tube	25	7AC	50.0	0.15	Single-Tube Class A Amplifier
50DC4	Half-Wave Rectifier	5D	5BQ	50	0.15	With Capacitive-Input Filter
50FE5	Beam Power Tube	13G	8KB	50.0	0.15	Class A Amplifier
50FK5	Power Pentode	5D	7CV	50.0	0.1	Class A Amplifier
50HC6	Power Pentode	5D	7FZ	50	0.15	Class A Amplifier
50JY6	Beam Power Tube	14L	9MG	50	0.5	Horizontal Deflection Amplifier
50X6	Rectifier-Doubler	12C	70X	50.0	0.15	Rectifier-Doubler
50Y6GT	Rectifier-Doubler	13D	7Q	50.0	0.15	Rectifier-Doubler
50Y7GT	Rectifier-Doubler Heater Tap for Pilot	13D	8AN Pilot Between Pins 6 and 7	50.0	0.15	Voltage Doubler Half-Wave Rectifier
50Z7G	Rectifier-Doubler Heater Tap for Pilot	22	8AN Pilot Between Pins 6 and 7	50.0	0.15	Voltage Doubler Half-Wave Rectifier
53	High-Mu Twin Power Triode	26	7B	2.5	2.0	Amplifier

Plate Volts	Grid Bias or Cathode Resistor	Screen Grid Volts	Screen Grid Cur- rent mA	Plate Cur- rent mA	AC Plate Resist- ance Ohms	Trans- conduct- ance Micromhos	Amplifi- cation Factor	Power		RCA Type	
								Load Ohms	Out- put Watts		
For other characteristics, refer to Type 35W4										35Y4	
For other ratings, refer to Type 35Z5GT										35Z3	
Max. DC Output mA, 100					Min. Total Effective Plate-Supply Impedance: Up to 117 volts, 15 ohms; at 235 volts, 100 ohms					35Z4GT	
100	— 1.5V	55	—	1.8	550000	850	—	—	—	36	
250	— 3V	90	1.7	3.2	550000	1080	—	—	—	36	
AC Plate Volts (RMS), 117 Max. DC Output mA, 82					Max. Peak Inverse Volts, 365 Tube Voltage Drop for Plate mA, 150, 20 volts					36AM3	
Max. AC Plate Volts (RMS), 120 Max. DC Output mA, 82					Max. Peak Inverse Volts, 365 Tube Voltage Drop for Plate mA, 150, 16 volts					36AM3A 36AM3B	
250	—18V	—	—	7.5	8400	1100	9.2	—	—	37	
250	—25V	250	3.8	22.0	100000	1200	—	10000	2.50	38	
250	{ — 3V min. }	90	1.4	5.8	1.0	1050	—	—	—	39/44	
180	— 3V	—	—	0.2	150000	200	30	—	—	40	
For other characteristics, refer to Type 6KD6										40KD6	
For other characteristics, refer to Type 6K6GT										41	
For other characteristics, refer to Type 6F6G										42	
For other characteristics, refer to Type 6EC4A/EY500										42EC4A/ PY500	
For other characteristics, refer to Type 25A6										43	
275	—56V	—	—	36.0	1700	2050	3.5	4600	2.00	45	
Max. Peak Inverse Volts, 350					Max. DC Output mA, 65			Max. Peak Plate mA, 390			45Z3
For other ratings, refer to Type 35Z5GT										45Z5GT	
250	—33V	—	—	22	2380	2350	5.6	6400	1.25	46	
250	450Ω	250	6.0	31	60000	2500	—	7000	2.7	47	
125	—20V	100	9.5	56	—	3900	—	1500	2.5	48	
135	—20V	—	—	6.0	4175	1125	4.7	11000	0.17	49	
450	—84V	—	—	55	1800	2100	3.8	4350	4.6	50	
For other characteristics, refer to Type 50L6GT										50A5	
For other characteristics, refer to Type 50C5										50B5	
135	—13.5V	135	3.5	58	9300	7000	—	2000	3.6	50C6G	
200	—14V	135	2.2	61	18300	7100	—	2600	6		
AC Plate Volts (RMS) 117 Max. Peak Inverse Plate Volts, 330					DC Output mA, 110 Max. Peak Plate mA, 720					50DC4	
For other characteristics, refer to Type 6FE5										50FE5	
110	62Ω	115	8.5	32	14000	12800	—	3000	1.2	50FK5	
110	62Ω	115	11.5	42	11000	14600	—	3000	1.4	50HC6	
Max. DC Plate Volts, 275 Max. Peak Positive-Pulse Plate Volts, 7700					Max. DC Cathode mA, 220 Max. Plate Dissipation, 13 watts					50JY6	
For other ratings, refer to Type 25Z6GT										50X6	
For other ratings, refer to Type 25Z6GT										50Y6GT	
Max. AC Volts per Plate (RMS), 117 Max. DC Output mA, 65					Min. Total Effective Plate-Supply Impedance per Plate, 15 ohms					50Y7GT	
Max. AC Volts per Plate (RMS), 235 Max. DC Output mA per Plate, 65					Min. Total Effic. Plate-Supply Imped. per Plate: At 117 volts, 15 ohms; at 150 volts, 40 ohms; at 235 volts, 100 ohms						
Max. DC Output mA, 65										50Z7G	
Max. DC Output mA per Plate, 65											
For other characteristics, refer to Type 6N7										53	

RCA Type	Name	Out-line	Terminal Diagram	Heater or Filament (F)		Use Values to right give operating conditions and characteristics for indicated typical use
				Volts	Amperes	
70L7GT	Rectifier-Beam Power Tube	13F	8AA	70.0	0.15	Amplifier Unit as Class A Amplifier Half-Wave Rectifier
75	Twin Diode—High-Mu Triode	24B	6G	6.3	0.3	Amplifier
78	Remote-Cutoff Pentode	24B	6F	6.3	0.3	Amplifier Mixer
80	Full-Wave Rectifier	26	4C	5.0F	2.0	With Capacitive-Input Filter With Inductive-Input Filter
83*	Full-Wave Mercury-Vapor Rectifier	27B	4C	5.0	3.0	With Capacitive-Input Filter With Inductive-Input Filter
84/6Z4	Full-Wave Rectifier	22 or 13H	5D	6.3	0.5	With Capacitive-Input Filter With Inductive-Input Filter
117L7 GT/M7GT	Rectifier-Beam Power Tube	13F	8AO	117	0.09	Amplifier Unit as Class A Amplifier Half-Wave Rectifier
117N7 GT	Rectifier-Beam Power Tube	13F	6AV	117	0.09	Amplifier Unit as Class A Amplifier Half-Wave Rectifier
117P7 GT	Rectifier-Beam Power Tube	13F	8AV	117	0.09	
117Z3	Half-Wave Rectifier	9D	4CB	117	0.04	With Capacitive-Input Filter
117Z4 GT	Half-Wave Rectifier	29F	5AA	117	0.04	With Capacitive-Input Filter
117Z6 GT	Rectifier-Doubler	13D	7Q	117	0.075	Voltage Doubler Half-Wave Rectifier
407A*	Medium-Mu Twin Triode	6A	487A	40 20	0.05 0.1	Class A Amplifier
408A*	Sharp-Cutoff Pentode	5B	7BD	20	0.05	Class A Amplifier
884*	Gas Triode	22	6Q2	6.3	0.6	Relaxation Oscillator Grid-Controlled Rectifier
955*	Medium-Mu Triode	acorn	58C	6.3	0.15	AF and RF Amplifier
959*	Pentode	acorn	58E	1.25F	0.05	Class A Amplifier
991*	Glow-Discharge Tube	Double Contact Caudalabra	991	—	—	Voltage Regulator
1612*	Pentagrid Amplifier	3	7T	6.3	0.3	Class A Amplifier
1614*	Beam Power Tube	4	7S	6.3	0.9	Class A, AB Amplifier
1619*	Beam Power Tube	4	7AW	2.5F	2.0	Class AB, C Amplifier
1620*	Sharp-Cutoff Pentode	3	7R	6.3	0.3	Class A Amplifier
1621*	Power Pentode	2B	7S	6.3	0.7	Class A Amplifier
1622*	Beam Power Tube	4	7S	6.3	0.9	Class AB, C Amplifier
1629*	Electron-Ray Tube	13H	7AL	12.6	0.15	Visual Indicator
1635*	High-Mu Twin Power-Triode	13D	8B	6.3	0.6	Power Amplifier
2076/ 5R4GB*	Full-Wave Rectifier	17D	5T	5F	2	
2081/ 6AW8A*	High-Mu Triode—Sharp-Cutoff Pentode	6E	9DX	6.3	0.45	Triode Unit as Class A Amplifier Pentode Unit as Class A Amplifier

* Industrial type

Plate Volts	Grid Bias or Cathode Resistor	Screen Grid Volts	Screen Grid Cur- rent mA	Plate Cur- rent mA	AC Plate Resist- ance Ohms	Trans- conduc- tance Micromhos	Amplifi- cation Factor	Power		RCA Type
								Ohms	Watts	
110	— 7.5V	110	3.0	40.0	15000	7500	—	2000	1.8	70L7GT
Max. Peak Inverse Volts, 350		Max. DC Output mA, 70		Max. Peak Plate mA, 420		Min. Total Effect. Plate-Supply Imped., 15 ohms				
For other characteristics, refer to Type 6SQ7										
For other characteristics, refer to Type 6K7										75
For other characteristics, refer to Type 6K7										78
AC Volts per Plate (RMS), 350		DC Output mA, 125		Min. Total Effect. Supply		imped. per Plate, 50 ohms				80
Max. Peak Inverse Volts, 1400		Max. Peak Plate mA, 440		Min. Value of Input Choke,		10 henries				
AC Volts per Plate (RMS), 500		Max. DC Output mA, 125		Max. Peak Plate mA, 440						
Max. Peak Inverse Volts, 1400		Max. DC Output Current,		— Condenser = 40 μF (max.)		83♦				
Max. AC Volts per plate (RMS) 450		225mA		— Choke = 3 henries (min.)						
Max AC Volts per plate (RMS) 500		Max. DC Output Current,								
AC Volts per Plate (RMS), 325		DC Output mA, 60		Total Effect. Supply		84/5Z4				
Max. Peak Inverse Volts, 1250		Max. Peak Plate mA, 180		imped. per Plate, 150 ohms						
AC Volts per Plate (RMS), 450		Max. DC Output mA, 60		Value of Input						
Max. Peak Inverse Volts, 1250		Max. Peak Plate mA, 180		Choke, 10 henries						
105	— 5.2V	105	4	43	17000	5300	—	4000	0.85	117L7
Max. AC Plate Volts (RMS), 117		Max. DC Output mA, 75		Min. Total Effect. Plate-		M7GT				
Maffl. Peak Inverse Volts, 350		Max. Peak Plate mA, 450		Supply Imped., 15 ohms						
100	— 6V	100	5	51	16000	7000	—	3000	1.2	117N7
Max. AC Plate Volts (RMS), 117		Max. DC Output mA, 75		Min. Total Effect. Plate-		GT				
Max. Peak Inverse Volts, 350		Max. Peak Plate mA, 450		Supply Impedance, 15 ohms						
For other characteristics, refer to Type 117L7/M7GT										117P7
										GT
Max. Peak Inverse Volts, 330		Max. DC Output mA, 90		Min. Total Effect. Plate-		117Z3				
		Max. Peak Plate mA, 540		Supply Imped., 20 ohms						
Max. Peak Inverse Volts, 350		Max. DC Output mA, 90		Min. Total Effect. Plate-		117Z4				
		Max. Peak Plate mA, 540		Supply Imped., 30 ohms						
AC Volts per Plate (RMS), 117		Min. Total Effective Plate-Supply Impedance per Plate:		117Z6						
DC Output mA, 60		Half-Wave, 30 ohms; Full-Wave, 15 ohms								
AC Volts per Plate (RMS), 235		Min. Total Effect. Supply Imped. per Plate: At 117		GT						
DC Output mA per Plate, 60		volts, 15 ohms; at 150 volts, 40 ohms; at 235 volts, 100 ohms								
150	240Ω	—	—	8.2	6350	5500	35	(each unit)		407A♦
120	200Ω	120	2.2	7	340000	5000	—	—	—	408A♦
	300 max	—	—	300 max (peak)	Average Anode Current = 75 mA (max.)				884♦	
	350 max	—	—	300 max (peak)						
250	—7	—	—	6.3	11400	2200	25	—	—	955♦
135	—3	67.5	0.4	1.7	800000	600	—	—	—	959♦
48-67	—	—	—	2	—	—	—	—	—	991♦
250	—3	100	6.5	5.3	600000	1100	Grid-No.3 Bias = -3V			1612♦
For other characteristics, refer to Type 6L6, 6L6GC										1614♦
300	—10	200	4	44	8800	—	—	—	3	1619♦
For other characteristics, refer to Type 6J7										1620♦
For other characteristics, refer to Type 6F6G										1621♦
For other characteristics, refer to Type 6L6, 6L6GC										1622♦
For other characteristics, refer to Type 6E5										1629♦
300	0	—	—	6.6	—	*(plate to plate)		12000*	10.4	1635♦
For other characteristics refer to Type 5R4GB. Horizontal operating position requires pins 1 and 4 in vertical plane.										2076/ 5R4GB♦
For other characteristics, refer to Type 6AW8										2081/ 6AW8A♦

RCA Type	Name	Out- line	Terminal Dia- gram	Heater or Filament (F)		Use Values to right give operat- ing conditions and charac- teristics for indicated typical use
				Volts	Amperes	
				2082/ 12AY7♦	Medium-Mu Twin Triode	
5636♦	Sharp-Cutoff Pentode	submini- ature	8DC	6.3	0.15	Class A Amplifier
5639♦	Semiremote-Cutoff Pentode	submini- ature	8DE	6.3	0.45	Class A Amplifier
5642♦	Half-Wave Rectifier	submini- ature	5642	1.25F	0.2	Pulsed Rectifier Service
5651WA♦	Glow Discharge Tube	5C	5B0	—	—	Voltage Reference
5654/ 6AK5W/ 6096♦ 5654W♦	Sharp-Cutoff Pentode	5B	7BD	6.3	0.175	Class A Amplifier
5663♦	Gas-Tetrode	5A	6CE	6.3	0.15	Thyratron
5670♦ 5670WA♦	Medium-Mu Twin Triode	6A	8CJ	6.3	0.35	Class A Amplifier
5672♦	Power Pentode	submini- ature	5672	1.25	0.05	Class A Amplifier
5678♦	RF Pentode	submini- ature	5678	1.25	0.05	Class A Amplifier
5686♦	Beam Power Tube	6B	9G	6.3	0.35	Class A Amplifier
5687♦	Medium-Mu Twin Triode	6B	9H	12.6 6.3	0.45 0.9	Class A Amplifier
5691♦	High-Mu Twin Triode	13A	8BD	6.3	0.6	Class A Amplifier
5692♦	Medium-Mu Twin Triode	13A	8BD	6.3	0.6	Class A Amplifier
5693♦	Sharp-Cutoff Pentode	8N	2A	6.3	0.3	Class A Amplifier
5696A♦	Gas Tetrode	5B	7BN	6.3	0.15	Relay Applications
5718♦	Medium-Mu Triode	submini- ature	8DK	6.3	0.15	Class A Amplifier
5719♦	High-Mu Triode	submini- ature	8DK	6.3	0.15	Class A Amplifier
5725♦ 5725/ 6AS6W♦	Sharp-Cutoff Pentode	5B	7CM	6.3	0.175	Class A Amplifier
5726♦ 5726/ 6AL5W/ 6097♦ 5726/ 6AL5W♦	Twin Diode	5B	6BT	6.3	0.3	Half-Wave Rectifier
5734♦	Mechano-Electronic Transducer	5734	5734	6.3	0.15	Vibration Measurements*
5749♦ 5749/ 6BA6W♦	Remote-Cutoff Pentode	5C	7BK	6.3	0.3	Class A Amplifier
5750♦	Pentagrid Converter	5C	7CH	6.3	0.3	Converter
5751WA♦	High-Mu Twin Triode	6B	9A	12.6 6.3	0.15 0.3	Class A Amplifier
5783♦	Glow Discharge Tube	submini- ature	5783	—	—	Voltage Reference
5814WA♦	Medium-Mu Twin Triode	6B	9A	12.6 6.3	0.15 0.3	Class A Amplifier
5824♦	Power Pentode	25	7S	25	0.3	Class A Amplifier
5840♦ 5840W♦	Sharp-Cutoff Pentode	submini- ature	8DE	6.3	0.15	Class A Amplifier

♦ Industrial type

Plate Volts	Grid Bias or Cathode Resistor	Screen Grid Volts	Screen Grid Cur- rent mA	Plate Cur- rent mA	AC Plate Resist- ance Ohms	Trans- conduct- ance Micromhos	Amplifi- cation Factor	Power		RCA Type
								Load Ohms	Out- put Watts	
For other characteristics, refer to Type 12AY7										2082/ 12AY7♦
100	150Ω	100	5.8	4	50000	1950	EC3 = -3V	—	—	5636♦
150	100Ω	100	4	21	50000	9000	—	—	—	5639♦
8000	—	—	—	0.15	—	Tube drop at 4 mA = 30 volts			5642♦	
For other characteristics, refer to Type 5651A										5651WA♦
For other characteristics, refer to Type 5654										5654/ 6AK5W/ 6096♦ 5654W♦
500	-10V	5	2	20	—	—	—	—	—	5653♦
150	240Ω	—	—	8.2	6400	5500	(each unit)	—	—	5670♦ 5670WA♦
67.5	-6.5V	67.5	1.1	3.25	—	650	—	20000	.065	5672♦
67.5	0	67.5	0.48	1.8	1M	1100	—	—	—	5678♦
250	-12.5V	250	3	27	45000	3100	—	9000	2.7	5686♦
250	-12.5V	—	—	12	3000	5400	16	(each unit)	—	5687♦
250	-2	—	—	2.3	44000	1600	70	(each unit)	—	5691♦
250	-9V	—	—	6.5	9100	2200	20	(each unit)	—	5692♦
250	-3V	100	0.83	3	—	1650	—	(Grid-No.3 = 0V)	—	5693♦
For other characteristics, refer to Type 5696										5696A♦
150	180Ω	—	—	13	4150	6500	27	—	—	5718♦
150	680Ω	—	—	1.85	30500	2300	70	—	—	5719♦
120	-2V	120	3.5	5.2	—	3200	—	(Grid-No.3 = 0V)	—	5725♦ 5725/ 6AS6W♦
For other characteristics, refer to Type 6AL5										5726♦ 5726/ 6AL5W/ 6097♦ 5726/ 6AL5W♦
300	0V	—	—	1.5	7200	275	—	7500	—	5734♦
* Up to 12,000 cycles per second.										5749♦ 5749/ 6BA6W♦
For other characteristics, refer to Type 6BA6										5750♦
For other characteristics, refer to Type 6BE6										5751WA♦
For other characteristics, refer to Type 5751										5783♦
85	—	—	—	1.5	—	—	—	—	—	5814WA♦
For other characteristics, refer to Type 5814A										5824♦
For other characteristics, refer to Type 25B6G										5840♦ 5840W♦
100	150Ω	100	2.4	7.5	260000	5000	—	—	—	5840W♦

RCA Type	Name	Out- line	Terminal Dia- gram	Heater or Filament (F)		Use Values to right give operat- ing conditions and charac- teristics for indicated typical use
				Volts	Amperes	
5842/ 417A♦	Medium-Mu Triode	6A	9V	6.3	0.3	Class A Amplifier
5844♦	Medium-Mu Twin Triode	5C	7BF	6.3	0.3	Class A Amplifier
5847/ 404A♦	Sharp-Cutoff Pentode	6A	9X	6.3	0.3	Class A Amplifier
5881♦	Beam Power Tube	29M	7AC	6.3	0.9	Class A Amplifier
5896♦	Twin Diode	submin- iature	8DJ	6.3	0.3	Full-Wave Rectifier
5899♦	Semiremote-Cutoff Pentode	submin- iature	8DE	6.3	0.15	Class A Amplifier
5902♦	Beam Power Pentode	submin- iature	8DE	6.3	0.45	Class A Amplifier
5915♦	Pentagrid Amplifier	5C	7CH	6.3	0.3	Class A Amplifier
5964♦	Medium-Mu Twin Triode	5C	7BF	6.3	0.45	Class A Amplifier
6005♦ 6005/ 6AQ5W 6095♦ 6005/ 6AQ5♦	Beam Power Tube	5D	7BZ	6.3	0.45	Class A Amplifier
6021♦	Medium-Mu Twin Triode	submin- iature	8DG	6.3	0.3	Class A Amplifier
6072♦ 6072A♦	Medium-Mu Twin Triode	6B	9A	6.3 12.6	0.15 0.3	Class A Amplifier
6073♦ 6073/ 0A2♦	Glow-Discharge Tube	5D	5B0	—	—	Voltage Regulator
6074♦ 6074/ 0B2♦	Glow-Discharge Tube	5D	5B0	—	—	Voltage Regulator
6080WA♦	Low-Mu Twin Triode	36	8BD	6.3	2.5	Voltage Regulator
6082♦	Low-Mu Twin Triode	36	8BD	26.5	0.6	Voltage Regulator
6101♦ 6101/ 6J6WA♦	Medium-Mu Twin Triode	5C	7BF	6.3	0.45	Class A Amplifier
6111♦	Medium-Mu Twin Triode	submin- iature	8DG	6.3	0.3	Class A Amplifier
6112♦	High-Mu Twin Triode	submin- iature	8DG	6.3	0.3	Class A Amplifier
6136♦	Sharp-Cutoff Pentode	5C	7BK	6.3	0.3	Class A Amplifier
6186♦ 6186/ 6AG5WA♦ 6186W♦	Sharp-Cutoff Pentode	5C	7BD	6.3	0.3	Class A Amplifier
6189♦	Medium-Mu Twin Triode	6B	9A	12.6 6.3	0.15 0.3	Class A Amplifier
6197♦	Power Pentode	6E	9BV	6.3	0.65	Class A Amplifier
6202♦	Twin Diode	5D	5BS	6.3	0.6	Full-Wave Rectifier
6206♦	Semiremote-Cutoff Pentode	submin- iature	8DC	6.3	0.15	Class A Amplifier
6211♦	Medium-Mu Twin Triode	6B	9A	12.6 6.3	0.15 0.3	Class A Amplifier

♦ Industrial type

Plate Volts	Grid Bias or Cathode Resistor	Screen Grid Volts	Screen Grid Cur- rent mA	Plate Cur- rent mA	AC Plate Resist- ance Ohms	Trans- conduc- tance Micromhos	Amplifi- cation Factor	Power		RCA Type
								Load Ohms	Out- put Watts	
150	60Ω	—	—	25	1700	25000	43	—	—	5842/ 417A♦
100	470Ω	—	—	4.8	7950	3400	27	(each unit)		5844♦
160	600Ω* *with 8.5 V in series	160	4.5	13	—	12500	—	—	—	5847/ 484A♦
250	—14V	250	4.3	75	30000	6100	—	2500	6.7	5881♦
350	—18V	250	2.5	53	48000	5200	—	4200	11.3	
150 RMS each plate				DC Output Current = 18 mA						5896♦
100	120Ω	100	2.2	7.2	260000	4500	—	—	—	5899♦
100	270Ω	100	2.2	30	15000	4200	—	3000	1	5902♦
67.5	0V	67.5	—	—	—	2000 1100	(grid No.4 voltage = -4 volts) (grid No.4 voltage = 0 volts)			5915♦
100	50Ω* * Common to both units	—	—	9.5	6500	6000	39	(each unit)		5964♦
For other characteristics, refer to Type 6AQ5A										6005♦ 6005/ 6AQ5W 6095♦ 6005/ 6AQ5♦
100	150Ω	—	—	6.5	6500	5400	35	—	—	6021♦
250	—4V	—	—	3	25000	1750	44	—	—	6072♦ 6072A♦
For other characteristics, refer to Type 0A2										6073♦ 6073/ 0A2♦
For other characteristics, refer to Type 0B2										6074♦ 6074/ 0B2♦
For other characteristics, refer to Type 6080										6080WA♦
For other characteristics, refer to Type 6080										6082♦
For other characteristics, refer to Type 6J6A										6101♦ 6101/ 6J6WA♦
100	220Ω	—	—	8.5	4000	5000	20	—	—	6111♦
150	820Ω	—	—	1.75	—	2500	70	—	—	6112♦
For other characteristics, refer to Type 6AU6A										6136♦
For other characteristics, refer to Type 6AG5										6186♦ 6186/ 6AG5WA♦ 6186W♦
For other characteristics, refer to Type 12AU7A										6189♦
250	—3V	250	70	30	90000	11000	—	—	—	6197♦
325 RMS, 4 μF input filter 450 RMS, 8 henry input choke				50 (each plate) 50 (each plate)						6202♦
100	120Ω	100	2.2	7.2	260000	4500	—	—	—	6206♦
100	470Ω	—	—	4.6	7500	3600	27	(each unit)		6211♦

RCA Type	Name	Out- line	Terminal Dia- gram	Heater or Filament (F)		Use Values to right give operat- ing conditions and character- istics for indicated typical use
				Volts	Amperes	
6336A ♦	Low-Mu Twin Triode	37	8BD	6.3	5.0	Class A Amplifier
6350 ♦	Medium-Mu Twin Triode	6E	9CZ	12.6 6.3	0.3 0.6	Class A Amplifier
6360 ♦ 6360A ♦	Twin Tetrode	6G	6360	12.6 6.3	0.41 0.82	Class AB ₁ Power Amplifier
6386 ♦	Medium-Mu Twin Triode	6A	8CJ	6.3	0.35	Class A Amplifier
6417 ♦	VHF Beam Power Tube	6E	9K	12.6	0.375	RF Power Amplifier
6485 ♦	Sharp-Cutoff Pentode	5C	7CC	6.3	0.45	Class A Amplifier
6626/ 0A2WA ♦	Glow-Discharge Tube	5D	5B0	—	—	Voltage Regulator
6660/ 6BAG ♦	Remote-Cutoff Pentode	5C	7BK	6.3	0.3	Class A Amplifier
6662/ 6BJ6 ♦	Remote-Cutoff Pentode	5C	7CM	6.3	0.15	Class A Amplifier
6663/ 6AL5 ♦	Twin Diode	5B	6BT	6.3	0.3	Half-Wave Rectifier
6664/ 6AB4 ♦	High-Mu Triode	5C	5CE	6.3	0.15	Class A Amplifier
6676/ 6CB6A ♦	Sharp-Cutoff Pentode	5C	7CM	6.3	0.3	Class A Amplifier
6677/ 6CL6 ♦	Power Pentode	6E	9BV	6.3	0.65	Class A Amplifier
6678/ 6U8A ♦	Medium-Mu Triode Sharp-Cutoff Pentode	6B	9AE	6.3	0.45	Triode Unit as Class A Amplifier Pentode Unit as Class A Amplifier
6686 ♦	Power Pentode	6E	9AU	6.3	0.375	Class A Amplifier
6688A ♦	Sharp-Cutoff Pentode	6A	9EQ	6.3	0.3	Class A Amplifier
6887 ♦	Twin Diode	5A	6BT	6.3	0.2	Half-Wave Rectifier
6922/ E88CC ♦	Medium-Mu Twin Triode	6B	9AJ	6.3	0.3	Class A Amplifier
6977 ♦	Indicator Triode	submi- niture	6977	1.0F	0.03	Logic Level Indicator
7027	Beam Power Tube	19F	8HY	6.3	0.9	Push-Pull Class AB ₁ Amplifier Push-Pull Class AB ₁ Amplifier
7044 ♦	Medium-Mu Twin Triode	6E	9H	6.3	0.9	Class A Amplifier
7054 ♦	Power Pentode	6B	9GK	13.5	0.275	Class A Amplifier
7055 ♦	Twin Diode	5B	6BT	13.5	0.155	Half-Wave Rectifier
7056 ♦	Sharp-Cutoff Pentode	5C	7CM	13.5	0.15	Class A Amplifier
7057 ♦	Medium-Mu Twin Triode	6B	9AJ	13.5	0.18	Class A Amplifier
7058 ♦	High-Mu Twin Triode	6B	9EP	13.5	0.155	Class A Amplifier
7060 ♦	Medium-Mu Triode Power Pentode	6B	9DA	13.5	0.28	Triode Unit as Class A Amplifier Pentode Unit as Class A Amplifier
7061 ♦	Beam Power Tube	6E	9EU	13.5	0.21	Class A Amplifier
7167 ♦	Sharp-Cutoff Tetrode	5C	7EW	13.5	0.09	VHF Class A Amplifier
7256 ♦	Medium-Mu Triode Sharp-Cutoff Pentode	6B	9DA	13.5	0.21	Triode Unit as Class A Amplifier Pentode Unit as Class A Amplifier
7308 ♦	Medium-Mu Twin Triode	6B	9AJ	6.3	0.335	Class A Amplifier
7360 ♦	Beam Deflection Tube	6E	9KS	6.3	0.35	Class A Amplifier

Plate Volts	Grid Bias or Cathode Resistor	Screen Grid Volts	Screen Grid Cur- rent mA	Plate Cur- rent mA	AC Plate Resist- ance Ohms	Trans- conduc- tance Micromhos	Amplifi- cation Factor	Power		RCA Type
								Load Ohms	Out- put Watts	
190	200Ω	—	—	—	200	13500	2.7	(each unit)		6336A*
150	-5V	—	—	11	3900	4600	18	(each unit)		6350*
300	-21.5V	200	1.2	30	—	3300	—	10000 plate to plate		6360* 6360A*
100	200Ω	—	—	9.6	4250	4000	17	—	—	6386*
For other characteristics, refer to Type 5763										6417*
For other characteristics, refer to Type 6AH6										6485*
For other characteristics, refer to Type OA2										6626/ OA2WA*
For other characteristics, refer to Type 6BA6										6660/ 6BA6*
For other characteristics, refer to Type 6BJ6										6662/ 6BJ6*
For other characteristics, refer to Type 6AL5										6AL5* 6663/
For other characteristics, refer to Type 6AB4										6664/ 6AB4*
For other characteristics, refer to Type 6CB6A										6676/ 6CB6A*
For other characteristics, refer to Type 6CL6										6677/ 6CL6*
For other characteristics, refer to Type 6U8A										6678/ 6U8A*
210	120Ω	210	5.3	20	300000	11000	—	15000	1	6686*
190	630Ω	160	3.3	13	90000	16500	grid-No.3 voltage = 0 volts grid-No.1 supply voltage = +9 volts		6688A*	
360 RMS (max.) each plate				—DC Plate Current = 10 mA max.						6887*
100	680Ω	—	—	15	—	12500	33	(each unit)		6922/ E88CC*
50	0V -3V	R _k = 100,000Ω		585μA 5μA	—	—	—	—	—	6977*
450	-30V	350	3.4□	95□	—	—	—	6000	50†	7027
400	200Ω	300	7□	112□	—	—	—	6600	32†	
380	180Ω	380	5.6□	138□	—	—	—	4500	36†	
410	220Ω	—	Cath. mA, 134		—	—	—	8000	24†	
120	-2V	—	—	36	1750	12000	21	(each unit)		7044*
For other characteristics, refer to Type 8077/7054										7054*
117 RMS each plate				—DC plate current 9 mA.						7055*
200	180Ω	150	2.8	9.5	600000	6200	—	—	—	7056*
150	220Ω	—	—	10	5300	6800	36	(each unit)		7057*
250	-2V	—	—	1.25	61000	1650	100	(each unit)		7058*
150	150Ω	—	—	9	8200	4900	40	—	—	7060*
200	82Ω	125	3.4	15	150000	7000	—	—	—	
200	-10V	200	9	35.5	60000	4200	—	5000	3	7061*
125	-1V	80	1.4	10	125000	8000	—	—	—	7167*
For other characteristics, refer to Type 6AN8A										7258*
For other characteristics, refer to Type 6922/E88CC										7308*
150 each plate	150Ω	175	2.1	8.5	—	5400 both plates tied	deflection electrode voltage = 25 volts		7360*	

† For two tubes at stated plate-to-plate load.

□ For two tubes.

RCA Type	Name	Out- line	Terminal Dia- gram	Heater or Filament (F)		Use Values to right give operat- ing conditions and charac- teristics for indicated typical use
				Volts	Amperes	
				7591	Beam Power Tube	
7695	Beam Power Tube	13D	9PX	50	0.15	Class A Amplifier Push-Pull Class AB ₁ Amplifier
7717/ 6CY5♦	Sharp-Cutoff Tetrode	5C	7EW	6.3	0.2	Class A Amplifier
7724/ 14GT8♦	Twin-Diode High-Mu Triode	6B	9KR	14	0.15	Triode Unit as Class A Amplifier
7788♦	Pentode	6B	9NK	6.3	0.34	Class A Amplifier
7898♦	High-Mu Twin Triode	6B	9EP	13.5	0.15	Class A Amplifier
8058♦	Novistor, High-Mu Triode	1A1	12CT	6.3	0.135	Class A Amplifier
8136♦	Sharp-Cutoff Pentode	5C	7CM	6.3	0.3	Class A Amplifier
8203♦	Novistor, Power Triode	1	12AQ	6.3	0.16	Class A Amplifier
8233♦	Pentode	11A	9PZ	6.3	0.6	Class A Amplifier
8532♦ 8532/ 6J4WA♦ 8532W♦	High-Mu Triode	5C	7BQ	6.3	0.4	Class A Amplifier
8627♦ 867A♦	Novistor, Power Triode	1A2	12CT	6.3	0.15	Class A Amplifier
8628♦	Novistor, High-Mu Triode	1	12AQ	6.3	0.1	Class A Amplifier
8808♦	Novistor, High-Mu Triode	1A3	8808	6.3	0.34	Class A Amplifier
8950♦	Beam Power Tube	16E	8950	13.0	1.1	Class A Amplifier
9001♦	Detector Amplifier Pentode	5F	7BD	6.3	0.15	Class A Amplifier
9002♦	Medium-Mu Triode	5F	7BS	6.3	0.15	Detector; Amplifier, Oscillator
9003♦	RF Pentode	5F	7BP	6.3	0.15	Class A Amplifier
9005♦	UHF Diode	acorn	5RG	3.6	0.165	Half-Wave Rectifier
9006♦	UHF Diode	5F	6BH	6.3	0.15	Half-Wave Rectifier
EM84/ 6FG6	Electron-Ray Tube	6F	9CA	6.3	0.27	Visual Indicator

♦ Industrial type

SAFETY PRECAUTIONS

Electron tubes that operate at potentials exceeding several thousand volts may emit X-radiation.

The high voltages associated with these devices result in production of X-radiation which may constitute a health hazard on prolonged exposure at close range unless the tube is adequately shielded. Equipment design must provide for this shielding.

Plate Volts	Grid Bias or Cathode Resistor	Screen Grid Volts	Screen Grid Cur- rent mA	Plate Cur- rent mA	AC Plate Resist- ance Ohms	Trans- conduc- tance Micromhos	Amplifi- cation Factor	Power		RCA Type	
								Load Ohms	Out- put Watts		
300	-10V	300	8	60	29000	10200	—	3000	11	7591	
450	200Ω	400	11.5□	82□	—	—	—	9000	28†		
130	-11V	130	5	100	7000	11000	—	1100	4.5	7695	
140	50Ω	140	9□	210□	—	—	—	1500	10†		
For other characteristics, refer to Type 6CY5										7717/ 6CY5♦	
For other characteristics, refer to Type 14G78										7724/ 14G78♦	
135	360Ω	165	5	35	—	50000	58	—	—	7788♦	
250	200Ω	—	—	10	10900	5500	60	(each unit)		7898♦	
110	47Ω	—	—	10	5600	12400	70	—	—	8058♦	
For other characteristics, refer to Type 6DK6										8136♦	
150	560Ω	—	—	7	5000	6000	30	—	—	8203♦	
125	-3V	125	5.5	50	20000	45000	—	—	—	8233♦	
150	100Ω	—	—	13.5	4800	11000	52.5	—	—	8532♦ 8532/ 6J4WA♦ 8532W♦	
110	47Ω	—	—	11.5	5400	13000	70	—	—	8627♦ 8627A♦	
120	200Ω	—	—	1.5	41000	3100	127	—	—	8628♦	
200	68Ω	—	—	15	6400	18000	100	—	—	8808♦	
175	-21V	110	2.0	120	—	16000	—	—	—	8950♦	
250	-3V	100	0.7	2.0	1 MΩ min.	1400	—	—	—	9001♦	
250	-7V	—	—	6.3	11400	2200	25	—	—	9002♦	
250	-3V	100	2.7	6.7	700000	1800	—	—	—	9003♦	
117 RMS max.					DC Output Current 1.0 mA max.					9005♦	
270 RMS					DC Output Current 5.0 mA					9006♦	
Triode Plate Supply Volts, 250						Fluorescent-Target Volts, 250					EM84/ 6FG6
Triode-Plate Resistance, 1 MΩ						Triode-Grid Resistance, 0.47 MΩ					
Triode Grid-Supply Volts, -22						Fluorescent Target mA, 1.6					
Max. Length of Dark Part of Target, when triode grid resistor = 0, 1.14 inch											

† For two tubes at stated plate to plate load.

□ For two tubes.

SAFETY PRECAUTIONS

Precautions must be exercised during the servicing of equipment employing these devices to assure that the high voltage is adjusted to the recommended value and that any shielding components are restored to their intended positions before the equipment is operated.

Caution: Operation of this tube outside of the maximum values indicated may result in either temporary or permanent changes in the X-radiation characteristics of the tube. Equipment design must be such that these maximum values are not exceeded.

Note: For Safety Precautions that apply to all tubes, refer to page 93.

Terminal Diagram Designations for Receiving Tubes

THE following pages contain comprehensive listings of domestic and foreign entertainment and industrial receiving tubes cross-referenced to a particular terminal diagram designation.

The first index gives the terminal diagram designations in numerical-alphabetical sequence and lists the tube types having the same diagram.

The second index lists receiving tube types in numerical-alphabetical-numerical sequence and gives the terminal diagram designation for each type.

These indexes can be used as an initial approach to tube interchangeability for types not listed in the Replacement Guides. Identical terminal diagram designations, however, do not imply interchangeability. Before any interchangeability is attempted, a comparison must be made of all essential data, including maximum ratings, performance characteristics and mechanical characteristics. Many types listed in these indexes are currently in RCA's line and data for them are included in this manual. For those tube types not currently in RCA's line, it may be necessary to consult other data sources.

The pin or terminal connections associated with the terminal diagram designations are given in the chart III. TERMINAL CONNECTIONS, immediately following the indexes.

I. TERMINAL DIAGRAM DESIGNATION vs. TYPE NUMBER

1AY2	4CG	4D	4R	5AM
1AY2	6AU4GT	6A3	0Z4A	45Z3
1AY2A	6AU4GTA	10	0Z4G	
	6AX4GT	20		5AP
3C	6AX4GTB	26	4V	1A3
1B3GT	6CQ4	30	1C21	DA90
1G3GT/1B3GT	6DA4	31	0A4G	
1G3GTA/1B3GT	6DE4	40		5AY
1J3	6DM4A	45	5A	6D4
1K3/1J3	6GK17	50	27	
1K3A/1J3	6W4GT		37	5B
1N2A	12AX4GT	4F		47
8016	12AX4GTA	11	5AA	
DY30	12AX4GTB		35Z4GT	5BC
U41	12D4	4G	117Z4GT	955
AR	12DM4	1V	U74	
4AA	12DM4A	A61	U76	5BE
1LE3	17AX4GT	PY81		959
	17AX4GTA	PY83	5AB	
4AJ	17D4	PY88	7Y4	5BG
0A3	17DE4	PY800	7Z4	9005
0A3A	17DM4	V153		
0C3	17DM4A		5AC	5BO
0C3A	19AU4		7B4	5651A
0D3	19AU4GTA	4K	14A4	5651WA
0D3A	22DE4	22		6073
	25AX4GT	32	5AD	6073/OA2
	25W4GT		1LA4	6074
4C		4M	1LB4	6074/OB2
5Z3		1A4P		6626/OA2WA
80	4CK	1B4P	5AG	OA2
83	5823	34	1LH4	OA2WA
				OB2
4CB	4D	4R	5AL	OB2WA
117Z3	2A3	0Z4	35Y4	OC2

5BQ 35W4 36AM3 36AM3A 36AM3B 50DC4 HY90	5E 35 36 15	5Y 1E5GP 1N5GT 1P5GT DF33 Z14	6AM 25CU6 HD94 HD96	6BW 1DN5 1U5 DAF92
5BS 6X4 6X4W 12X4 6Z02 EZ90 EZ900 HZ90 U78 U707 VSM70	5F 38 39/44	5Z 1H5GT HD14	6AR 1L4 1T4 1U4 DE91 DF904 W17	6BX 3V4 DL94 N19
5BT 6BG6G 6CD6G 6CD6GA 6DN6 6EX6 19BG6G 19BG6GA 21EX6 25CD6GA 25CD6GB 25DN6 25EC6	5K 1F4 33	6A 48	6AS 6B5	6C 19
5C 46 49 6485 8136	5L 5V4G 5V4GA	6AA 7A5 7C5 14A5 14C5 32A5 50A5 EL22 KT81 N148	6AU 1S5 AD17 DAF91	6CC 6AR5
5CE 6AB4 6664/6AB4 EC92	5M 6F5 6F5GT 12F5GT H63	6AB 6SF5 12SF5 12SF5GT	6AX 1LD5	6CE 5663
5D 6Z4 84/6Z4	5N 1D5GT 1G4GT	6AD 35Z5GT 45Z5GT	6BA 3LF4	6CK 6AU5GT 6AV5GA 6AV5GT 6FW5 12AV5GA 25AV5GA
5DA 5AR4/GZ34 GZ32 GZ34 GZ37 R-52 U54 U70	5O 5X4G 5Y4G 5Y4GA 5Y4GT	6AE 7B5	6BB 6C4 EC90 L77 M8080 QA2401 QL77 V741	6CN 6BY5GA
5DE 30G4	5P 1H4G 6B4G	6AF 1Q5GT	6BD 9006	6CO 6012
5E 24A	5Q 2T4 5AS4 5AS4A 5AU4 5AW4 5AZ4 5R4GB 5R4GYB 5U4G 5U4GB 5V3 5V3A/5AU4 5W4 5W4GT 5Y3G 5Y3GT 5Z4 2076/5R4GB GZ30 RJ2 U50 U52	6AG 7B5	6BE 6C4 EC90 L77 M8080 QA2401 QL77 V741	6D 25B5
	5R 1D5GT 1G4GT	6AM 6BQ6GT 6BQ6GTB/6CU6 6CU6 6DQ6A 6DQ6B 6GB3A 6GB6 6GB7 6GW6 6GW6/6DQ6B 12BQ6GTB/12CU6 12CU6 12DQ6A 12DQ6B 12GB3 12GB6 12GB7 12GW6/12DQ6B 17BQ6GTB 17DQ6A 17GB3 17GW6/17DQ6B 25BQ6GT 25BQ6GTB/25CU6	6BH 9006	6E 6AJ8/ECH81 25Y5 25Z5
	5S 1H4G 6B4G	6AN 6BQ6GT 6BQ6GTB/6CU6 6CU6 6DQ6A 6DQ6B 6GB3A 6GB6 6GB7 6GW6 6GW6/6DQ6B 12BQ6GTB/12CU6 12CU6 12DQ6A 12DQ6B 12GB3 12GB6 12GB7 12GW6/12DQ6B 17BQ6GTB 17DQ6A 17GB3 17GW6/17DQ6B 25BQ6GT 25BQ6GTB/25CU6	6BS 2050 2050A	6EC4 6EC4/EY500 42EC4A/PY500 EY500 PY500
	5T 2T4 5AS4 5AS4A 5AU4 5AW4 5AZ4 5R4GB 5R4GYB 5U4G 5U4GB 5V3 5V3A/5AU4 5W4 5W4GT 5Y3G 5Y3GT 5Z4 2076/5R4GB GZ30 RJ2 U50 U52	6AO 35Z5GT 45Z5GT	6BT 3AL5 6AL5 12AL5 5726 6663/6AL5 6887 7055 D2M9 D63 D152 EAA91 EB91 FAA91 HAA91 QA2404 XXA-91	6F 6C6 6D6 78
	5U 6K5GT	6AP 7B5	6BU 9006	6G 2A6 12Z3 75
	5V 1D5GP	6AQ 7B5	6BV 9006	6K 6Z5
		6AR 1L4 1T4 1U4 DE91 DF904 W17	6BW 9006	6L 1A6 1C6

6M 1B5/25S	7AC 6W6GT 6Y6GA/6Y6G 7EY6 12EN6 12L6GT 12V6GT 12W6GT 25C6G 25L6 25L6GT/25W6GT 25W6GT 35L6GT 50C6G 50L6GT 7408 7581A EL37 KT-32 KT66 KT71 OSW3106	7AV 1S4 DL91	7BF 5964 ECC91 M8081 T2M05	7BT 3AV6 4AV6 6AQ6 6AT6 6AV6 6BF6 12AE6 12AE6A 12AJ6 12AT6 12AV6 12BF6 12FK6 12FM6 18FY6 18FY6A 26C6 DH77 EBC90 EBC91 HBC90 HBC91
6Q 6AC5GT 6C5 6C5GT 6J5 6J5GT 6L5G 6P5GT 12J5GT 25AC5GT 884 L63 L63B	7AF 1F7G	7AW 1619	7BK 3AU6 3BA6 4AU6 6AH6 6AH6WA 6AK6 6AU6 6AU6A 6AU6WB 6BA6/EF93 6BD6 6HR6 6HS6 12AC6 12AF6 12AU6 12BA6 12BD6 12BL6 12CX6 12DZ6 12EA6 12EK6 12EK6/12DZ6/ 12EA6 18GD6A 19HR6 19HS6 19MR9 26A6 5749 6660/6BA6 7543 EF93 EF94 HF93 HF94 M8108 PM04 W727 XF94	7BZ 5AQ5 6AQ5 6AQ5A 6BF5 6DS5 6HG5 6HR5 11DS5 12AQ5 35B5 50B5 6005 6669/6AQ5A BPM04 EL90 M8245 N727
6R 2E5 6AB5/6N5 6E5 6U5 EM35 OSW3110 Y61	7AG 6AD6G 6AF6G	7BA 3Q4 3S4 DL92 DL95 N17 N18		
6S 6AX5GT 6X5 6X5GT 6ZY5G EZ35	7AH 6AE6G	7BB 3A4	7BC 3A5	
6W 1F6	7AJ 7A6	7BD 3BC5 3BC5/3CE5 3CE5 4BC5 6AG5 6AK5/EF95 6AN5 6BC5/6CE5 6CE5 6RHH2 408A 5654 6186 9001 9003 DP61 EF95 EF96 EF905 PM05		
6X 1A5GT 1C5GT 1F5G 1G5G 1J5G 1T5GT DL31	7AK 1LA6 1LC6			
7AA 1H6G	7AL 1629			
7AB 1G6GT 1J6G 1J6GT	7AM 1N6G			
7AC 5V6GT 6EY6 6EZ5 6L6 6L6G 6L6GB 6L6GC 6V6 6V6GT 6V6GTA	7AD 1LG5 1LN5			
	7AP 3Q5GT DL33 N16			
	7AQ 1LC5			
	7AT 1R5 DK91 X17			
	7AU 6N6G			
		7BF 5J6 5MHH3 6J6 6J6A 6J6WA 6MHH3 19J6 5844		
			7BN 2D21 5696 5696A 5727	
			7BQ 6J4 8532	
			7BR 6F4	
			7BS 9002	
				7CC 18FW6 18FW6A
				7CH 3BE6 3BY6 3CS6 4CS6 6BE6 6BY6 6CS6 12AD6 12BE6 12EG6 12GA6

7CH

18FX6
18FX6A
26D6
5750
5915
EH90
EK90
HK90
HM04
X77
X107
X727

7CK

12U7

7CM

3BZ6
3CB6/3CF6
3CF6
3DK6
4BZ6
4CB6
4DE6
4DK6
4EW6
4GM6
4JH6
4LU6
5EW6
5GM6
5JK6
5JL6
6AS6
6BH6
6BJ6
6BZ6
6CB6A/6CF6
6CF6
6DC6
6DE6
6DK6
6EW6
6GM6
6JH6
6JK6
12AW6
12BZ6
12DK6
5725
6661/6BH6
6662/6BJ6
6676/6CB6A
7056
EF190

7CV

4GZ5
6AS5
6CA5
6CU5
6EH5
12C5
12CA5

7CV

12CN5
12CU5/12C5
12ED5
12EH5
12FX5
17C5
17CU5/17C5
19FX5
25C5
25CA5
25EH5
25F5A
32ET5
32ET5A
34GD5
34GD5A
35C5
35EH5
50C5
50EH5
50FK5
60FX5
HL92

7CY

3B4WA
6GZ5

7D

2B7
6B7
6B7S

7DC

1L6

7DF

3BN6
4BN6
6BN6/6KS6
6KS6
12BN6

7DK

2AF4A/2AF4B
2AF4B/2DZ4
2DZ4
3AF4A
3AF4A/3DZ4
3DZ4
6AF4
6AF4A
6AN4
6DZ4
6T4
EC94

7DQ

6DL5
6DL5/EL95
EL95

7DX

50X6

7E

6F7

7EA

6CR6
12CR6

7EG

2BN4
2BN4A
3BN4
3BN4A
6BN4
6BN4A

7EK

12K5

7EN

3DT6
3DT6A
4DT6
4DT6A
5GX6
5HZ6
6DT6
6DT6A
6GX6
6GY6
6GY6/6GX6
6HZ6

7EW

2CY5
3CY5
3EA5
4CY5
6CY5
6EA5
6EV5
7167
7717/6CY5

7F

12A5

7FB

12EL6

7FL

2EN5

7FP

2ER5
2FH5
2FQ5A
2GK5/2FQ5A
3ER5
3FH5
3GK5
4GK5
6ER5
6ES5
6FH5

7FP

6FQ5A
6FY5/EC97
6GK5/6FQ5A
EC95
EC97
PC95
XC95
XC97
YC95

7FQ

6FV6

7FZ

35GL6
50HC6
50HK6

7G

6C7

7GA

2FS5
2GU5
3FS5
6FS5
6GU5

7GM

2HA5
2HM5/2HA5
2HQ5
3HM5/3HA5
3HQ5
4HA5
4HA5/PC900
4HQ5
6HA5
6HA5-S
6HK5
6HM5/6HA5
6HQ5
EC900
LC9J0
PC900
XC900

7GW

17DQ6B

7H

6D7
6E7

7K

12A7

7Q

6H6
6H6GT
12H6
25Z6
25Z6GT
50Y6GT
117Z6GT
EB34

7R

6J7
6J7G
6J7GT
6K7
6K7G
6K7GT
6S7
6S7G
6U7G
6W7G
1217GT
12K7GT
1620
A863
EF37
KTW63
KTZ63
W61
W63
Z63

7S

6DG6GT
6F6
6F6G
6F6GT
6G6G
6K6GT
12A6
25A6
25A6GT
25B6G
1613
1614
1621
1622
5824
5881
6550
8417
EM840
KT-63
N63

7T

6L7
6L7G
1612

7U

6P7G

7V

6B6G
6Q7
6Q7G
6Q7GT
6R7
6R7G
6R7GT
6T7G
6V7G

7V 12Q7GT DH63	8B 6N7 6N7GT 6Y7G 6Z7G 1635	8C 1E7GT	8ET 6CA7/EL34 6CZ7 EL34	8K 6K8 6K8G 6K8GT 12K8
7W 25N6G		8CB 6S8GT 12S8GT	8EZ 3A3 3A3/3B2 3A3A/3B2 3A3B 3A3C 3AW3 3CZ3 3CZ3A	8KB 6FE5 50FE5
7Z 1A7GT 1B7GT 1C7G 1D7G	8BD 6AS7G 6BL7GT 6BL7GTA 6BX7GT 6DN7 6EA7 6EM7/6EA7 6GL7 6SL7GT 6SN7GT 6SN7GTA 6SN7GTB 10EG7 10EM7 12SL7GT 12SN7GT 12SN7GTA 12SX7GT 13EM7 13EM7/15EA7 5691 5692 6080 6080WA 6082 6336A B36 B65 ECC32 ECC35	8CH 6AL7GT		8KN 7355
8A 6A8 6A8G 6A8GT 6D8G 12A8GT PH4 X63		8CJ 5670 6386		8KQ 7591 7591A
8AA 70L7GT		8CK 6AQ7GT ECL180	8F 25A7GT	8KS 5DJ4
8AC 7F7 7N7 14AF7 14F7 14N7		8CN 1E8	8FU 6BD4 6BD4A	8LY 8417
8AD 6SA7GT 12SA7GT		8CP 1AC5 1AD5	8G 6C8G 6F8G	8MG 50JY6
8AE 7E7 7R7 9U8A 14E7 14R7		8CT 6BA7 12BA7	8GB 6BL4	8MH 3CA3 3CA3A
8AJ 1D8GT		8DA 1T6	8GC 6BK4 6BK4A 6BK4B 6BK4C/6EL4A 6EL4	8MK 3CU3A
8AL 7Q7		8DC 5636 6206	8GD 6CB5 6CB5A	8ML 6LH6A
8AN 50Y7GT 50Z7G		8DE 5639 5840 5899 5902	8GN 3B2	8MQ 6LJ6 6LJ6A/6LH6A
8AO 117L7/M7GT	8BE 12AH7GT	8DG 6021 6111 6112	8GT 25E5/PL36 N308 PL36	8MT 3CX3 3DF3 3DF3A
8AS 3A8GT	8BF 7K7	8DJ 5896	8H 6J8G	8MU 2CN3A 3CN3A 3CN3B
8AV 117N7GT 117P7GT	8BK 6SG7 6SH7 12SG7 12SH7	8DK 5718 5719 6814	8HY 7027 7027A	8MX 3DB3 3DB3/3CY3 3DJ3
8AY 6AD7G	8BL 7S7 14J7	8E 6B8 6B8G 12C8	8JB 6CK4	8MY 3DA3/3DH3
	8BU 26A7GT	8EL 6AH4GT	8JC 6DQ5	8MZ 3DC3
	8BW 7F8 14F8	8EP KT88	8JP 6DZ7	8N 6AB7 6AC7 6AC7W

8N	8V	9A	9AG	9AQ
6SJ7	7A7	6680/12AU7A	12B4A	EF811
6SJ7GT	7AD7	6681/12AX7A		EF814
6SJ7Y	7AG7	7025	9AJ	LF183
6SK7		7247	4BC8	LF184
6SK7GT	8V	8152	4BQ7A	XF183
6SS7	7AH7	B309	4BQ7A/4BZ7	XF184
12SJ7	7B7	B329	4BS8	YF183
12SJ7GT	7C7	B339	4BZ7	YF184
12SK7	7G7	B739	4ES8/XCC189	
12SK7GT	7L7	B749	4KN8/4RHH8	9AU
5693	7V7	B759	4RHH2	6686
KT77	14A7	E81CC	5BQ7A	
OSW3111	14C7	E82CC	5BQ7A	9AX
	14H7	E83CC	5ES8/YCC189	6BC7
8NB	EF22	ECC81	6AQ8	6BJ7
26HU5	W81	ECC82	6AQ8/ECC85	
	W143	ECC83	6BC8/6BZ8	9BD
8NC	W148	ECC186	6BK7A	6V3A
26LW6		ECC801	6BK7B	EY81F
		ECC802	6BQ7	9BF
8ND	8W	ECC803	6BQ7/6BZ7/6BS8	11HM7
1DG3	7B6	M8136	6BS8	12BV7
1DG3A	7C6	M8137	6BZ7	12BY7
	7E6	M8162	6BZ8	12BY7A/12BV7/
8NJ	14B6	PCC18	6D18/ECC88	12DQ7
6EN4	14E6	QA2406	6D18	12DQ7
		QB309	6ES8/ECC189	12GN7
8NL	8X	XCC82	6JK8	12GN7A
3DR3	14B8		6KN8/6RHH8	12HG7
3DS3		9AC	9AQ8/PCC85	12HG7/12GN7A
		6S4	12DT8	12HL7
8NP	8Y	6S4A	17EW8	EL180
6MA6	6AG4Y		17EW8/HCC85	9BL
	6AG7	9AD	6922/E88CC	7189
		5879	7057	
8Q	8Z		7308	9BQ
6AE5GT	32L7GT	9AE	B719	6BK5
6SQ7		5EA8	ECC85	12BK5
6SQ7GT	9A	5GH8A	ECC88	25BK5
6SR7	6AU7	5KD8	ECC180	
6ST7	7AU7	5U8	ECC189	9BV
6SZ7	9AU7	6AX8	HCC85	6CL6
12SQ7	12AE7	6EA8	PCC85	6197
12SQ7GT	12AT7/ECC81	6GH8	XCC189	6677/6CL6
12SR7	12AT7WA	6GH8A	YCC189	
12SR7GT	12AT7WB	6GJ8	YCL180	9BX
12SW7	12AU7	6HL8		6AM4
OBC3	12AU7A/ECC82	6KD8	9AK	9CA
OSW3105	12AV7	6LM8	5X8	6AJ8
	12AX7	6MQ8	6X8A	
	12AX7A/ECC83	6MU8	19X8	9CB
8R	12AY7	6U8		6AF3
6SA7	12AZ7	6U8A/6KD8	9AQ	6AL3
6SB7Y	12AZ7A	9EA8	3EH7	6AL3/EY88
12SA7	12BH7	9GH8A	3EH7/XF183	6BR3/6RK19
12SY7	12BH7A	9JW8/PCF802	3EJ7	6RK19
OSW3104	12BZ7	19EA8	3EJ7/XF184	12AF3/12BR3/
	12DW7	6678/6U8A	4EH7/LF183	12RK19
8S	12FV7	7059	4EJ7/LF184	12BR3
6SC7	5751	CXF80	6EH7/EF183	12RK19
12SC7	5814A	ECF82	6EJ7	16AQ3
	5963	ECF82	6EJ7/EF184	16AQ3/XY88
8T	5965	LCF802	EF183	17BR3
12B8GT	6072	PCF802	EF184	17BR3/17K19
25B8GT	6189			17RK19
	6211			
8U	6679/12AT7			
7A8				

9CB 17Z3/PY81 20AQ3/LY88 30AE3/PY88 34R3 EY88 LY88 XY88	9DC 6MG8 8A8 9A8 9A8/PCF80 ECF80 LCF80 LZ319 LZ329 PCF80 XCF80	9DX 8AW8A 8BA8A 8BH8 8CX8 8EB8 8GN8 8JV8 10GN8 10HF8 10JA8/10LZ8 10JT8 10JY8 10KR8 10LB8 10LW8 10LY8 10LZ8 11JE8 11KV8 11LQ8 PCF82	9EU 6GC5 12AB5 6973 7061	9FT 6CH8
9CF 9BR7 12BR7	9DE 4RHH8 6RHH8 ECC89	9EZ 5AV8	9EX 6BM8/ECL82 8B8 11BM8 16A8/PCL82 50BM8/UCL82 ECL82 LCL82 LN119 N369 PCL82 UCL82 UCL83	9FX 5CL8 5CL8A 6CL8 6CL8A 9CL8 19CL8A
9CK 6CM6 6DW5	9DJ 6BW4 12BW4	9FA 5BR8 5BR8/5FV8 5FV8 5MB8 6BR8 6BR8A 6FV8 6FV8A 6JN8 6MB8 12EC8 12JN8 19HV8 19JN8/19CL8A	9FZ 5KZ8 6CM8 6KZ8 9KZ8	9G 5686
9CV 6BQ5/EL84 6CW5 6CW5/EL86 8BQ5 8CW5/XL86 10BQ5 10CW5 10CW5/LL86 15CW5 15CW5/PL84 EL84 EL86 LL86 M709 PL84 XL84 XL86	9DP 6AR8 6JH8	9GE 5T8 6AK8/EABC80 6T8 6T8A 19T8 DL012 EABC80	9GA 6FG6/EM84 6HU6/EM87 EM84 EM87	9GC 12J8
9CY 5AM8 6AM8 6AM8A 6HJ8	9DR 6BC4	9ED 6AZ8	9GE 5CQ8 6CQ8	9GF 4LJ8 5CG8 5FG7 5GS7 5LJ8 6CG8 6CG8A 6FG7 6GS7 6LJ8 7GS7
9CZ 6350	9DS 5AS8 6AS8	9EF 6CS7 8CS7	9GF 3BU8/3GS8 3HS8 4BU8 4BU8/4GS8 4HS8 4MK8 6BU8 6HS8 6MK8 6MK8A	9GK 6GK6 7KY6 9KX6 9LA6 10GK6 16GK6 7054 8077/7054 PCL800
9DA 5AN8 6AN8 6AN8A 10C8 12CT8 7060 7258	9DT 1RK23 1S2A/DY87 3A2 3A2A DY87	9EG 5BE8 5DH8	9FH 12F8	9GM 6CU8
9DC 4BL8 4BL8/XCF80 4KE8 5JW8 5KE8 6BL8 6BL8/ECF80 6JW8/ECF802 6KE8 6LN8 6LN8/LCF80 6LX8/LCF802	9DW 5AT8 6AT8 6AT8A	9EN 6CN7 8CN7	9FJ 6BV8	9GR 6DB5 12DB5
	9DX 6AU8 6AU8A 6AW8 6AW8A 6BA8A 6BH8 6CX8 6EB8 6GN8 6HF8 6HZ8 6JE8 6JT8 6JV8 6KR8 6KV8 6LB8 6LF8 6LQ8 6LY8 6MV8 8AU8	9EP 7058 7898	9FK 17H3	9GS 12AL8
		9EQ 6688A	9FN 6BY8 EF80	
		9ER 6BJ8 6BN8 8BN8		
		9ES 6CM7 8CM7		

9H 5687 7044	9HP 17AY3 17AY3A 17BH3 17BS3 17BS3A/17DW4A 17CK3 17DW4A 22BH3 22BH3A 25CK3	9KR 14JG8 7724/14GT8	9LY 10GV8/LCL85 11MS8 18GV8/PCL85 19KG8 ECL85 LCL85 PCL85 XCL85	9NZ 6GT5 6GT5A 12GT5 12GT5A 17GT5 17GT5A 7868
9HE 6DC8 6DC8/EBF89 EBF85 EBF89	9HR 12DL8 12DV8	9KS 7360	9LZ 6GW8/ECL86 ECL86	9PA 6JC8
9HF 6DE7 6DR7 6EW7 6FD7 9RAL1 10DE7 10DR7 10EW7 13DE7 13DR7 13FD7	9HV 12EM6	9KT 12FQ8	9M 6CA4 E24 U709 UU12	9PB 7905
9HG 12DE8	9HX 6DX8 6DX8/ECL84 10DX8 10DX8/LCL84 15DQ8/PCL84 ECL84 LCL84	9KV 12FX8 12FX8A	9MB 6GY8	9PC 20EZ7
9HK 5BW8 6BW8	9HZ 12DK7	9LG 6CY7 11CY7	9MP 5HG8 5HG8/LCF86 6HG8 6HG8/ECF86 7HG8 7HG8/PCF86 ECF86 LCF86 PCF86	9PL 8106
9HL 6939	9JD 12DY8	9LK 7551 7558	9MQ 6GM5	9PM 3JC6 3JC6A 3JD6 3KT6 4HM6 4HT6 4JC6A 4JD6 4KT6 6HM6 6JC6A 6JD6 6KT6
9HN 5CZ5 6CZ5 6DT5 6EM5 8EM5 12DT5	9JE 35DZ8	9LP 6CG7 6EV7 6FQ7 6FQ7/6CG7 6GU7 8CG7 8FQ7 8FQ7/8CG7 8GU7 12FQ7	9MR 6FA7	9PQ 6JU8 6JU8A 8JU8A
9HP 6AY3 6AY3B 6BA3 6BH3 6BH3A 6BS3 6BS3A 6CH3 6CJ3/6CH3 6CK3 6CL3 6CL3/6CK3 6CM3 6DN3 6DW4 6DW4B 12AY3 12AY3A 12BS3 12BS3A/12DW4A 12CL3 12DW4A	9JF 5EU8 6EU8	9LQ 6EQ7 6KL8 12EQ7 12KL8 20EQ7	9NH 6GB5 6GB5/EL500 13GB5 13GB5/XL500 17BB14 18GB5/LL500 27GB5/PL500 EL500 LL500 PL500 XL500	9PV 6KA8 8KA8
9HT 6EY3 6EY3A 6EY3B 6EY3C 6EY3D 6EY3E 6EY3F 6EY3G 6EY3H 6EY3I 6EY3J 6EY3K 6EY3L 6EY3M 6EY3N 6EY3O 6EY3P 6EY3Q 6EY3R 6EY3S 6EY3T 6EY3U 6EY3V 6EY3W 6EY3X 6EY3Y 6EY3Z	9JG 6EH8	9LS 6EU7	9NJ 6HU8/ELL80	9PX 7695
9HU 6FZ3 6FZ3A 6FZ3B 6FZ3C 6FZ3D 6FZ3E 6FZ3F 6FZ3G 6FZ3H 6FZ3I 6FZ3J 6FZ3K 6FZ3L 6FZ3M 6FZ3N 6FZ3O 6FZ3P 6FZ3Q 6FZ3R 6FZ3S 6FZ3T 6FZ3U 6FZ3V 6FZ3W 6FZ3X 6FZ3Y 6FZ3Z	9JT 7199	9LT 6ET7 6KU8 8ET7 10KU8	9NK 7788	9PZ 8233
9HV 6GZ3 6GZ3A 6GZ3B 6GZ3C 6GZ3D 6GZ3E 6GZ3F 6GZ3G 6GZ3H 6GZ3I 6GZ3J 6GZ3K 6GZ3L 6GZ3M 6GZ3N 6GZ3O 6GZ3P 6GZ3Q 6GZ3R 6GZ3S 6GZ3T 6GZ3U 6GZ3V 6GZ3W 6GZ3X 6GZ3Y 6GZ3Z	9JU 12DS7 12DS7A	9LW 3GS8/3BU8 3GS8 4GS8 4GS8/4BU8	9NW 6HA6 6HB6/6HA6	9QA 4GJ7/XCF801 4GX7 5GJ7/LCF801 5GX7 5HB7 6GJ7 6GJ7/ECF801 6GX7 6HB7 6HD7 8GJ7 8GJ7/PCF801 ECF801 LCF801 PCF801 XCF801
9HW 6H3 6H3A 6H3B 6H3C 6H3D 6H3E 6H3F 6H3G 6H3H 6H3I 6H3J 6H3K 6H3L 6H3M 6H3N 6H3O 6H3P 6H3Q 6H3R 6H3S 6H3T 6H3U 6H3V 6H3W 6H3X 6H3Y 6H3Z	9K 5763 6417	9LY 6GV8 6GV8/ECL85 9GV8 9GV8/XCL85	9NY 6DL4/EC88 EC88	

9QD 6GF7 6GF7A 10GF7 10GF7A 13GF7 13GF7A	9QT 21LR8 31LR8	9RT 2BJ2 2BJ2A	12AQ 7586 7895 8056 8203 8393 8628	12CA 6M11 165X11
9QG 6KM8	9QU 6JG6 6JG6A 6JR6 6JT6 6JT6A 6KV6 6KV6A 12JT6 12JT6A 17JG6 17JG6A 17JT6 17JT6A 17KV6A 22JG6 22JG6A 22JR6 22KV6A 33JR6	9RU 6ME8	9RX 12CT3 17CT3 25CT3	12CT 8058 8627
9QJ 5BC3 5BC3A	9QK 6GJ5 6GJ5A 12GJ5 12GJ5A 17GJ5 17GJ5A	9SB 25HX5	12AS 7587	12DA 6AG11 6AY11
9QL 6JB6 6JB6A 6JE6 6JE6A 6JF6 6JU6 6KM6 6LQ6/6JE6B 6LQ6/6JE6C 6LZ6 6ME6 6MJ6/6LQ6/ 6JE6C 12JB6 12JB6A 17JB6 17JB6A 17JF6 22JF6 22JU6 22KM6 24JE6A 24LQ6/24JE6C 24LZ6 31LQ6 31LZ6 36MC6	9QY 6LC8 8LC8	9SG 6DK3	12BF 6B10 8B10	12DG 2AH2
9RA 6JQ6 12JQ6 17JQ6	9RZ 6LE8 10LE8 15LE8	9U 1V2 2AV2	12BJ 6GE5 6GF5 6HB5 12GE5 17GE5 21HB5 21HB5A	12DM 6AR11 8AR11 8BQ11 8CB11 11AR11 11BQ11 16BQ11
9RF 9XC6	9RG 1BC2 1BC2A 1BH2 1BH2A	9V 5842/417A	12BL 6AX3 6BJ3 12AX3 12BT3 17AX3	12DP 6AF11 6AS11 6BD11 15AF11 15BD11 15BD11A
9RM 6GQ7 19GQ7	9RL 6LT8 8LT8 11LT8	9X 5847/404A	12BM 6FJ7	12DR 6GV5 6GY5 16GY5 17GV5 21GY5
9QP 6KT8	9RQ 6MD8 12MD8	9Y 1AX2 1X2A 1X2B/1X2A 1X2C DY80 R-19	12BQ 6C10 6D10 ECH42 X150	12DZ 6JZ8 6LU8 6MF8 13JZ8 15MF8 16LU8A 17JZ8 21LU8 23JZ8 24JZ8 25JZ8
9QT 6KY8 6KY8A 6LR8 15KY8 15KY8A 17LD8	9RQ 6MD8 12MD8	10F 6C9 17C9	12BT 6J10 6Z10/6J10 10Z10 13J10 13Z10 13Z10/13J10 17AB10/17X10 17X10	12EA 2DV4 6DV4
		10K 5U9/LCF201 6U9/ECF201 6X9/ECF200 ECF200 ECF201 LCF201	12BU 6AL11 6G11 10AL11 12AL11	12EJ 6FM7 13FM7 13FM7/15FM7 15FM7
		10L 6AF9 5Y9/EFL200 11AF9 11Y9 11Y9/LFL200 17Y9 LFL200	12BW 6J11	12EO 6FY7
		12AQ 2CW4 2DS4 2EG4 6CW4 6DS4 13CW4	12BY 6AV11 6K11 6K11/6Q11 6Q11	

12EO 11FY7 15FY7	12FK 6JN6 12JN6 17JN6 21JV6 33JV6	12FY 30MB6 31JS6A 31JS6C 35LR6	12GY 6HV5A 6HZ5 6HZ5/6JD5	12HU 6MN8 9MN8
12ER 6BA11 8BA11		12GA 6BE3/6BZ3 12BE3 17BE3/17BZ3	12GZ 16AK9 23Z9	12HW 11CF11
12ES 12HE7	12FL 6HJ5 21HJ5		12HA 3AW2 3AW2A	12HX 19DE3
12EV 6JB5/6HE5	12FM 6T9	12GC 14BL11	12HB 6BV11 12BV11	12HY 3BS2A 3BT2 3BW2 3BW2/3BS2A/ 3BT2
12EW 2AS2 2AS2A	12FN 33GY7 33GY7A 50GY7A	12GD 6JZ6 21JZ6 30JZ6	12HC 6EJ4A	12JA 26LX6
12EY 6HE5 6JA5 5JB5 10JA8	12FP 6BH11 8BU11	12GF 6BN11 8BN11	12HD 6BW11	12JB 2BU2 2BU2/2AH2
12EZ 6AD10 6BF11 6BY11 6T10 10T10 12AE10 12BF11 12T10 13V10 17BF11 18A110 24BF11	12FQ 4HA7 4HA7/4HC7 5HA7	12GH 21KA6	12HE 6AG9 8AL9	12JE 6JH5
	12FR 4HC7	12GJ 6LB6	12HF 6BW3 6CD3 6CE3 6CG3/6CE3/ 6CD3/6BW3	12JH 12JF5
	12FS 38HE7 38HK7 53HK7	12GK 34CE3	12HG 6MJ8	17HB25 17HB25
	12FU 8BM11 9BJ11	12GL 14BR11	12HJ 6AH9 9AH9	407A 407A
12FA 6EA4 6EH4A 6EH7	12FV 3AT2 3AT2B 3BN2 3BN2A	12GS 11BT11 11CH11	12HK 3BL2 3BL2A 3BM2	991 991
12FB 6HF5	12FX 17BW3 17BZ3 22BW3	12GU 6KN6 42KN6	12HL 21LG6 21LG6A	5642 5642
12FC 33GT7	12FY 6JS6 6JS6A 6JS6C 6LR6 21JS6A 23JS6A	12GV 1AD2 1AD2A	12HN 11CA11	5672 5672
12FE 6AC10 6AK10 6U10 8AC10 9AK10 9AM10 12AC10A		12GW 6KD6 6LF6 20LF6 30KD6 36KD6 36KD6/40KD6 40KD6	12HR 31AL10	5678 5678
12FJ 6JM6 6JM6A 17JM6A		12GY 6HS5 6HV5	12HT 32HQ7	5734 5734
				5783 5783
				6360A 6360A
				6977 6977
				8808 8808
				8950 8950

II. TYPE NUMBER vs. TERMINAL DIAGRAM DESIGNATION

Type No.	Terminal Diagram	Type No.	Terminal Diagram	Type No.	Terminal Diagram	Type No.	Terminal Diagram	Type No.	Terminal Diagram
1A3	5AP	11A4	5AD	2CY5	7EW	3BT2	12HY	3KT6	9PM
1A4P	4M	11A6	7AK	2D21	7BN	3BU8/		3LF4	6BA
1A5GT	6X	11B4	5AD	2DS4	12AQ	3GS8	9FG	3Q4	7BA
1A6	6L	11C5	7AQ	2DV4	12EA	3BW2	12HY	3Q5GT	7AP
1A7GT	7Z	11C6	7AK	2DZ4	7DK	3BW2/		3S4	7BA
1AC5	8CP	11D5	6AX	2E5	6R	3BS2A/		3V4	6BX
1AD2	12GV	11E3	4AA	2EG4	12AQ	3BT2	12HY	4AU6	7BK
1AD2A	12GV	11G5	7A0	2EN5	7FL	3BY6	7CH	4AV6	7BT
1AD5	8CP	11H4	5AG	2ER5	7FP	3BZ6	7CM	4BC5	7BD
1AX2	9Y	11N5	7A0	2FH5	7FP	3CA3	8MH	4BC8	9AJ
1AY2	1AY2	1N2A	3C	2FQ5A	7FP	3CA3A	8MH	4BL8	9DC
1AY2A	1AY2	1N5GT	5Y	2F55	7GA	3CB6/		4BL8/	
1B3GT	3C	1N6G	7AM	2GK5/		3CF6	7CM	XCE80	9DC
1B4P	4M	1P5GT	5Y	2FQ5A	7FP	3CE5	7BD	4BN6	7DF
1B5/25S	6M	1Q5GT	6AF	2GU5	7GA	3CF6	7CM	4BQ7A	9AJ
1B7GT	7Z	1R5	7AT	2HA5	7GM	3CN3A	8MU	4BQ7A/	
1BC2	9RG	1RK23	9DT	2HQ5	7GM	3CN3B	8MU	4BZ7	9AJ
1BC2A	9RG	1S2A/		2T4	5T	3CS6	7CH	4BS8	9AJ
1BH2	9RG	DY87	9DT	3A2	9DT	3CU3A	8MK	4BU8	9FG
1BH2A	9RG	1S4	7AV	3A2A	9DT	3CX3	8MT		
1C5GT	6X	1S5	6AU	3A3	8EZ	3CY5	7EW	4BU8/	
1C6	6L	1T4	6AR	3A3/3B2	8EZ	3CZ3	8EZ	4GS8	9FG
1C7G	7Z	1T5GT	6X	3A3A/		3CZ3A	8EZ	4BZ6	7CM
1C21	4V	1T6	8DA	3B2	8EZ	3DB3	8MX	4BZ7	9AJ
1D5GP	5Y	1U4	6AR	3A3B	8EZ	3DB3/		4CB6	7CM
1D5GT	5R	1U5	6BW	3A3C	8EZ	3CY3	8MX	4CS6	7CH
1D7G	7Z	1V	4G	3A4	7BB	3DC3	8MZ	4CY5	7EW
1D8GT	8AJ	1V2	9U	3A5	7BC	3DF3	8MT	4DF6	7CM
1DG3	8ND	1X2A	9Y	3A8GT	8AS	3DG4	5DE	4DK6	7CM
1DG3A	8ND			3AF4A	7DK	3DJ3	8MX	4DT6	7EN
1DN5	6BW	1X2B/		3AF4A/		3DK6	7CM	4DT6A	7EN
1E5GP	5Y	1X2A	9Y	3DZ4	7DK	3DT6	7EN	4EH7/	
1E7GT	8C	1X2C	9Y	3AL5	6BT	3DT6A	7EN	LF183	9AQ
1E8	8CN	2A3	4D	3AT2	12FV	3DZ4	7DK	4EJ7/	
1F4	5K	2A5	6B	3AT2B	12FV	3EA5	7EW	LF184	9AQ
1F5G	6X	2A6	6G	3AU6	7BK	3EH7	9AQ	4ES8/	
1F6	6W	2A7	7C	3AV6	7BT	3EH7/		XCC189	9AJ
1F7G	7AF	2AF4A/		3AW2	12HA	XF183	9AQ	4EW6	7CM
1G3GT/		2AF4B	7DK	3AW2A	12HA	3EJ7	9AQ	4GJ7/	
1B3GT	3C			3AW3	8EZ			XCE801	9QA
1G3GTA/		2AF4B/		3B2	8GH	3EJ7/		4GK5	7FP
1B3GT		2DZ4	7DK	3B4WA	7CY	XF184	9AQ	4GM6	7CM
1G4GT	3C	2AH2	12DG	3BA6	7BK	3ER5	7FP	4GS8	9LW
1G5G	6X	2AS2	12EW	3BC5	7BD	3FH5	7FP	4GS8/	
1G6GT	7AB	2AS2A	12EW	3BC5/		3FS5	7GA	4BU8	9LW
1H4G	5S	2AV2	9U	3CE5	7BD	3GK5	7FP	4GX7	9QA
1H5GT	5Z	2B7	7D	3BE6	7CH	3GS8/		4GZ5	7CV
1H6G	7AA	2BJ2	9RT	3BL2	12HK	3BU8	9LW	4HA5	7GM
1J3	3C	2BJ2A	9RT	3BL2A	12HK	3GS8	9LW	4HA5/	
1J5G	6X	2BN4	7EG	3BM2	12HK			PC900	7GM
1J6G	7AB	2BN4A	7EG	3BN2	12FV	3HM5/		4HA7	12FQ
1J6GT	7AB	2BU2	12JB	3BN2A	12FV	3HA5	7GM	4HA7/	
1K3/1J3	3C	2BU2/		3BN4	7EG	3HQ5	7GM	4HC7	12FQ
1K3A/1J3	3C	2AH2	12JB	3BN4A	7EG	3HS8	9EG	4HC7	12FR
1L4	6AR	2CN3A	8MU	3BN6	7DF	3JC6	9PM	4HM6	9PM
1L6	7DC	2CW4	12AQ	3BS2A	12HY	3JC6A	9PM	4HQ5	7GM

TERMINAL DIAGRAM DESIGNATIONS

605

Type No.	Terminal Diagram	Type No.	Terminal Diagram	Type No.	Terminal Diagram	Type No.	Terminal Diagram	Type No.	Terminal Diagram
4HS8	9FG	5HG8	9MP	6AE6G	7AH	6AU6A	7BK	6BJ3	12BL
4JC6A	9PM	5HG8/ LCF86	9MP	6AE7GT	7AX	6AU6WB	7BK	6BJ6	7CM
4JD6	9PM			6AF3	9CB	6AU7	9A	6BJ7	9AX
4JH6	7CM	5HZ6	7EN	6AF4	7DK	6AU8	9DX	6BJ8	9ER
4KF8	9DC	5J6	7BF	6AF4A	7DK	6AU8A	9DX	6BK4	8GC
4KN8/ 4RH8	9AJ	5JK6	7CM	6AF6G	7AG	6AV5GA	6CK	6BK4A	8GC
4KT6	9PM	5JL6	7CM	6AF9	10L	6AV5GT	6CK	6BK4B	8GC
4LJ8	9GF	5JW8	9DC	6AF11	12DP	6AV6	7BT	6BK4C/ 6EL4A	8GC
4LU6	7CM	5KD8	9AE	6AG4Y	8Y	6AV11	12BY	6BK5	9BQ
		5KE8	9DC	6AG5	7BD	6AW8	9DX		
4RHH2	9AJ	5KZ8	9FZ	6AG7	8Y	6AW8A	9DX	6BK7A	9AJ
4RHH8	9DE	5LJ8	9GF	6AG9	12HE	6AX3	12BL	6BK7B	9AJ
5AM8	9CY	5M88	9FA	6AG11	12DA	6AX4GT	4CG	6BL4	8GB
5AN8	9DA	5MHH3	7BF	6AH4GT	8EL	6AX4GTB	4CC	6BL7GT	8BD
5AQ5	7BZ	5R4GYB	5T	6AH6	7BK	6AX5GT	6S	6BL7GTA	8BD
5AR4/ GZ34	5DA	5T8	9E	6AH6WA	7BK	6AX8	9AE	6BL8	9DC
5AS4	5T	5U4G	5T	6AH9	12HJ	6AY3	9HP	6BL8/ ECF80	9DC
5AS4A	5T	5U4GB	5T	6AK5/ EF95	7BD	6AY3B	9HP	6BM8/ ECL82	9EX
5AS8	9DS	5HA7	12FQ	6AK6	7BK	6AY11	12DA		
		5U8	9AE			6AZ8	9ED		
5AT8	9DW	5U9/ LCF201	10K	6AK8/ EABC80	9E	6B4G	5S	6BN4	7EG
5AU4	5T			6AK10	12FE	6B5	6AS	6BN4A	7EG
5AV8	9DZ	5V3	5T	6AL3	9CB	6B6G	7V	6BN6/ 6KS6	7DF
5AW4	5T	5V3A/ 5AU4	5T	6AL3/ EY88	9CB	6B7	7D	6BN8	9ER
5AZ4	5T			6AL5	6BT	6B7S	7D	6BN8	9ER
5B8	9EC	5V4G	5L	6AL7GT	8CH	6B8	8E	6BN11	12GF
5BC3	9QJ	5V4GA	5L	6AL11	12BU	6B8G	8E	6BQ5/ EL84	9CV
5BC3A	9QJ	5V6GT	7AC	6AM4	9BX	6B10	12BF	6BQ6GT	6AM
5BE8	9EG	5W4	5T			6BA3	9HP		
5BK7A	9AJ	5W4GT	5T	6AM8	9CY	6BA6/ EF93	7BK	6BQ6GTB/ 6CU6	6AM
5BQ7A	9AJ	5X4G	5Q	6AM8A	9CY	6BA7	8CT	6BQ7	9AJ
5BR8	9FA	5X8	9AK	6AN4	7DK	6BA8A	9DX	6BQ7A/ 6BZ7/ 6BS8	9AJ
5BR8/ 5FV8	9FA	5Y3G	5T	6AN5	7BD	6BA11	12ER		
5BT8	9FE	5Y4G	5Q	6AN8	9DA	6BC4	9DR	6BR3/ 6RK19	9CB
5BW8	9HK	5Y4GA	5Q	6AN8A	9DA	6BC5/ 6CE5	7BD	6BR8	9FA
5CG8	9GF	5Y4GT	5Q	6AQ5	7BZ	6BC7	9AX	6BR8A	9FA
5CL8	9FX	5Z3	4C	6AQ5A	7BZ				
5CL8A	9FX	5Z4	5T	6AQ6	7BT				
5CQ8	9GE	6A3	4D	6AQ7GT	8CK				
5CZ5	9HN	6A6	7B	6AQ8	9AJ	6BC8/ 6BZ8	9AJ	6BS3	9HP
5DH8	9EG	6A7	7C	6AQ8/ ECC85	9AJ	6BD4	8FU	6BS3A	9HP
5DJ4	8KS	6A7S	7C	6AR5	6CC	6BD4A	8FU	6BS8	9AJ
5EA8	9AE	6A8	8A	6AR8	9DP	6BD6	7BK	6BU8	9FC
5ES8/ YCC189	9AJ	6A8G	8A	6AR8	9DP	6BD6	7BK	6BV8	9FS
5EU8	9IF	6A8GT	8A	6AR11	12DM	6BD11	12DP	6BV11	12HB
5EW6	7CM	6AB4	5CE	6AS5	7CV	6BE3/ 6BZ3	12GA	6BW3	12HF
5FG7	9GF	6AB5/ 6N5	6R	6AS6	7CM	6BE6	7CH	6BW4	9DJ
5FV8	9FA	6AB7	8N	6AS7G	8BD	6BF5	7BZ	6BW8	9HK
				6AS8	9DS			6BW11	12HD
5GH8A	9AE	6AC5GT	6Q	6AS11	12DP	6BF6	7BT	6BX7GT	8BD
5GJ7/ LCF801	9QA	6AC7	8N	6AT6	7BT	6BF11	12EZ	6BY5GA	6CN
5GM6	7CM	6AC7W	8N	6AT8	9DW	6BG6G	5BT	6BY6	7CH
5GS7	9GF	6AC10	12FE	6AT8A	9DW	6BH3	9HP	6BY8	9FN
5GX6	7EN	6AD6G	7AG	6AU4GT	4CG	6BH3A	9HP	6BY11	12EZ
5GX7	9QA	6AD7G	8AY	6AU4GTA	4CG	6BH6	7CM	6BZ6	7CM
5HB7	9QA	6AD10	12EZ	6AU5GT	6CK	6BH8	9DX	6BZ7	9AJ
		6AE5GT	8Q	6AU6	7BK	6BH11	12FP	6BZ8	9AJ

Type No.	Terminal Diagram	Type No.	Terminal Diagram	Type No.	Terminal Diagram	Type No.	Terminal Diagram	Type No.	Terminal Diagram
6C4	6BG	6CX8	9DX	6EA8	9AE	6FS5	7GA	6GY6/	
6C5	6Q	6CY5	7EW	6EB8	9DX	6FV6	7FQ	6CX6	7EN
6C5GT	6Q	6CY7	9LG	6EC4/		6FV8	9FA	6GY8	9MB
6C6	6F	6CZ5	9HN	EY500	6EC4	6FV8A	9FA	6GZ5	7CY
6C7	7G	6CZ7	8ET	6EH4A	12FA	6FW5	6CK	6H6	7Q
6C8G	8G	6D4	5AY	6EH5	7CV	6FY5/		6H6GT	7Q
6C9	10F	6D6	6F	6EH7	12FA	EC97	7FP	6HA5	7GM
6C10	12BQ	6D7	7H	6EH7/		6FY7	12E0	6HA6	9NW
6CA4	9M	6D8G	8A	EF183	9AQ	6G6G	7S	6HB5	12BJ
6CA5	7CV	6D10	12BQ	6EH8	9JG	6G11	12BU	6HB6/	
6CA7/		6DA4	4CG	6EJ4A	12HC	6GB3A	6AM	6HA6	9NW
EL34	8ET	6DB5	9GR	6EJ7	9AQ	6GB5	9NH	6HB7	9QA
6CB5	8GD	6DC6	7CM	6EJ7		6GB5/		6HE5	12EY
6CB5A	8GD	6DC8	9HE	EF184	9AQ	EL500	9NH	6HF5	12FB
6CB6A/		6DC8/		6EL4	8GC	6GB6	6AM	6HF8	9DX
6CF6	7CM	EBF89	9HE	6EM5	9HN	6GB7	6AM	6HG5	7BZ
6CD3	12HF	6DE4	4CG	6EM7/		6GC5	9EU	6HG8	9MP
6CD6G	5BT	6DE6	7CM	6EA7	8BD	6GE5	12BJ	6HG8/	
6CD6GA	5BT	6DE7	9HF	6EN4	8NJ	6GF5	12BJ	ECF86	9MP
6CE3	12HF	6DG6GT	7S	6EQ7	9LQ	6GF7	9QD	6HJ5	12FL
6CE5	7BD	6DJ8/		6ER5	7FP	6GF7A	9QD	6HJ8	9CY
6CF6	7CM	ECC88	9AJ	6ES5	7FP	6GH8	9AE	6HK5	7GM
6CG3/		6DK3	9SG	6ES8/		6GH8A	9AE	6HL8	9AE
6CE3/		6DK6	7CM	ECC189	9AJ	6GJ5	9QK	6HMS/	
6CD3/		6DL4/		6ET7	9LT	6GJ5A	9QK	6HA5	7GM
6BW3	12HF	EC88	9NY	6EU7	9LS	6GJ7	9QA	6HM6	9PM
6CG7	9LP	6DL5	7DQ	6EU8	9JF	6GJ7/		6HQ5	7GM
6CG8	9GF	6DL5/		6EV5	7EW	ECF801	9QA	6HR5	7BZ
6CG8A	9GF	EL95	7DQ	6EV7	9LP	6GJ8	9AE	6HR6	7BK
6CH3	9HP	6DM4A	4CG	6EW6	7CM			6HS5	12GY
6CH8	9FT	6DN3	9HP	6EW7	9HF	6GK5/		6HS6	7BK
6CJ3/		6DN6	5BT	6EX6	5BT	6FQ5A	7FP	6HS8	9FG
6CH3	9HP	6DN7	8BD	6EY6	7AC	6GK6	9GK	6HU6/	
6CK3	9HP	6DQ5	8JC	6EZ5	7AC	6GK17	4CG	EM87	9GA
6CK4	8JB	6DQ6A	6AM	6EZ8	9KA	6GL7	8BD	6HU8/	
6CL3	9HP	6DQ6B	6AM	6F4	7BR	6GM5	9MQ	ELL80	9NJ
6CL3/		6DR7	9HF	6F5	5M	6GM6	7CM	6HV5	12GY
6CK3	9HP	6DS4	12AQ	6F5GT	5M	6GN8	9DX	6HV5A	12GY
6CL6	9BV	6DS5	7BZ	6F6	7S	6GQ7	9QM	6HZ5	12GY
6CL8	9FX	6DT5	9HN	6FG6	7S	6GS7	9GF		
6CL8A	9FX	6DT6	7EN	6FG6T	7S	6GT5	9NZ	6HZ5/	
6CM3	9HP	6DT6A	7EN	6F7	7E	6GT5A	9NZ	6JD5	12GY
6CM6	9CK	6DT8	9AJ	6F8G	8G	6GU5	7GA	6HZ6	7EN
6CM7	9ES	6DV4	12EA	6FA7	9MR	6GU7	9LP	6HZ8	9DX
6CM8	9FZ	6DW4	9HP	6FD7	9HF	6GV5	12DR	6JA	7BQ
6CN7	9EN	6DW4B	9HP	6FE5	8KB	6GV8	9LY	6J5	6Q
6CQ4	4CG	6DW5	9CK	6FG6/		6GV8/		6J5GT	6Q
6CQ8	9GE	6DX8	9HX	EM84	9GA	ECL85	9LY	6J6	7BF
6CR6	7EA	6DX8/		6FG7	9GF	6GW6	6AM	6J6A	7BF
6CS6	7CH	ECL84	9HX	6FH5	7FP	6GW6/		6J6WA	7BF
6CS7	9EF	6DZ4	7DK	6FH8	9KP	6DQ6B	6AM	6J7	7R
6CU5	7CV	6DZ7	8JP	6FJ7	12BM	6GW8/		6J7G	7R
6CU6	6AM	6E5	6R	6FM7	12EJ	ECL86	9LZ	6J7GT	7R
6CU8	9GM	6E6	7B	6FM8	9KR	6GX6	7EN	6J8G	8H
6CW4	12AQ	6E7	7H	6FQ5A	7FP	6GX7	9QA	6J10	12BT
6CW5	9CV	6EA4	12FA	6FQ7	9LP	6GY5	12DR	6J11	12BW
6CW5/		6EA5	7EW	6FQ7/		6GY6	7EN	6JB5/	
EL86	9CV	6EA7	8BD	6CG7	9LP			6HE5	12EV

TERMINAL DIAGRAM DESIGNATIONS

607

Type No.	Terminal Diagram	Type No.	Terminal Diagram	Type No.	Terminal Diagram	Type No.	Terminal Diagram	Type No.	Terminal Diagram
6JB6	9QL	6KN8/		6MK8A	9FG	6U8A/		7L7	8V
6JB6A	9QL	6RHH8	9AJ	6MN8	12HU	6KD8	9AE	7N7	8AC
6JC6A	9PM	6KR8	9DX	6MQ8	9AE	6U9/		7Q7	8AL
6JC8	9PA	6KS6	6DF	6MU8	9AE	ECF201	10K	7R7	8AE
6JD6	9PM	6KT6	9PM	6MV8	9DX	6U10	12FE	7S7	8BL
6JE6	9QL	6KT8	9QP	6N6G	7AU	6V3A	9BD	7V7	8V
6JE6A	9QL	6KU8	9LT	6N7	8B	6V6	7AC	7X7	8BZ
6JE8	9DX	6KV6	9QU	6N7GT	8B	6V6GT	7AC	7Y4	5AB
6JF6	9QL	6KV6A	9QU	6P5GT	6Q	6V6GTA	7AC	7Z4	5AB
6JG6	9QU	6KV8	9DX	6P7G	7U	6V7G	7V	8A8	9DC
6JG6A	9QU	6KY8	9QT	6Q7	7V	6W4GT	4CG	8AC10	12FE
6JH5	12JE	6KY8A	9QT	6Q7G	7V	6W6GT	7AC	8AL9	12HE
6JH6	7CM	6KZ8	9FZ	6Q7GT	7V	6W7G	7R	8AR11	12DM
6JH8	9DP	6L5G	6Q	6Q11	12BY	6X4	5BS	8AU8	9DX
6JK6	7CM	6L6	7AC	6R7	7V	6X4W	5BS	8AW8A	9DX
6JK8	9AJ	6L6G	7AC	6R7G	7V	6X5	6S	8B8	9EX
6JM6	12FJ	6L6GB	7AC	6R7GT	7V	6X5GT	6S	8B10	12BF
6JM6A	12FJ	6L6GC	7AC	6RHH2	7BD	6X8A	9AK	8BA8A	9DX
6JN6	12FK	6L7	7T	6RHH8	9DE	6X9/		8BA11	12ER
6JN8	9FA	6L7G	7T	6RK19	9CB	ECF200	10K	8BH8	9DX
6JQ6	9RA	6LB6	12GJ	6S4	9AC	6Y6GA/		8BM11	12FU
6JR6	9QU	6LB8	9DX	6S4A	9AC	6Y6G	7AC	8BN8	9ER
6JS6	12FY	6LC8	9QY	6S7	7R	6Y7G	8B	8BN11	12GF
6JS6A	12FY	6LE8	9QZ	6S7G	7R	6Y9/		8BQ5	9CV
6JS6C	12FY	6LF6	12GW	6S8GT	8CB	EFL201	10L	8BQ11	12DM
6JT6	9QU	6LF8	9DX	6SA7	8R	6Z4	5D	8BU11	12FP
6JT6A	9DX	6LH6A	8ML	6SA7GT	8AD	6Z5	6K	8CB11	12DM
6JT8	9QU	6LJ6	8MQ	6SB7Y	8R	6Z7G	8B	8CG7	9LP
6JU6	9QL	6LJ6A/		6SC7	8S	6Z10/		8CM7	9ES
6JU8	9PQ	6LH6A	8MQ	6SF5	6AB	6J10	12BT	8CN7	9EN
6JU8A	9PQ	6LJ8	9GF	6SF7	7AZ	6ZY5G	6S	8CS7	9EF
6JV8	9DX	6LM8	9AE	6SG7	8BK	7A5	6AA	8CW5/	
6JW8/		6LN8	9DC	6SH7	8BK	7A6	7AJ	XL86	9CV
ECF802	9DC	6LN8/		6SJ7	8N	7A7	8V	8CX8	9DX
6JZ6	12GD	LCF80	9DC	6SJ7GT	8N	7A8	8U	8EB8	9DX
6JZ8	12DZ	6LQ6/		6SJ7Y	8N	7AD7	8V	8EM5	9HN
6K5GT	5U	6JE6B	9QL	6SK7	8N	7AG7	8V	8E77	9LT
6K6GT	7S	6LQ6/		6SK7GT	8N	7AH7	8V	8FQ7	9LP
6K7	7R	6JE6C	9QL	6SL7GT	8BD	7AU7	9A	8FQ7/	
6K7G	7R	6LQ8	9DX	6SN7GT	8BD	7B4	5AC	8CG7	9LP
6K7GT	7R	6LR6	12FY	6SN7GTA	8BD	7B5	6AE	8GJ7	9QA
6K8	8K	6LR8	9QT	6SN7GTB	8BD	7B6	8W	8GJ7/	
6K8G	8K	6LT8	9RL	6SQ7	8Q	7B7	8V	PCF801	9QA
6K8GT	8K	6LU8	12DZ	6SQ7GT	8Q	7C5	6AA	8GN8	9DX
6K11	12BY	6LX8/		6SR7	8Q	7C6	8W	8GU7	9LP
6K11/		LCF802	9DC	6SS7	8N	7C7	8V	8JU8A	9PQ
6Q11	12BY	6LY8	9DX	6ST7	8Q	7E6	8W	8JV8	9DX
6KA8	9PV	6LZ6	9QL	6SZ7	8Q	7E7	8AE	8KA8	9PV
6KD6	12GW	6M11	12CA	6T4	7DK	7EY6	7AC	8LC8	9QY
6KD8	9AE	6MB8	9FA	6T7G	7V	7F7	8AC	8LT8	9RL
6KE8	9DC	6MD8	9RQ	6T8	9E	7F8	8BW	9A8	9DC
6KG6A/		6ME6	9QL	6T8A	9E	7G7	8V	9A8/	
EL509	9RJ	6ME8	9RU	6T9	12FM	7GS7	9GF	PCF80	9DC
6KL8	9LQ	6MF8	12DZ	6T10	12EZ	7HG8	9MP	9AH9	12HJ
6KM6	9QL	6MG8	9DC	6U5	6R	7HG8/		9AK10	12FE
6KM8	9QG	6MHH3	7BF	6U7G	7R	PCF86	9MP	9AM10	12FE
6KN6	12GU	6MJ8	12HG	6U8	9AE	7K7	8BF	9AQ8/	
		6MK8	9FG			7KY6	9GK	PCC85	9AJ

Type No.	Terminal Diagram	Type No.	Terminal Diagram	Type No.	Terminal Diagram	Type No.	Terminal Diagram	Type No.	Terminal Diagram
9AU7	9A	11CH11	12GS	12AZ7	9A	12DS7	9JU	12JN6	12FK
9BJ11	12FU	11C77	9LG	12AZ7A	9A	12DS7A	9JU	12JN8	9FA
9BR7	9CF	11DS5	7BZ	12B4A	9AG	12DT5	9HN	12JQ6	9RA
9CL8	9FX	11FY7	12EO	12B8GT	8T	12DT8	9AJ	12JT6	9QU
9GH8A	9AE	11HM7	9BF	12BA6	7BK	12DV8	9HR	12JT6A	9QU
9GV8	9LY	11JE8	9DX	12BA7	8CT	12DW4A	9HP	12K5	7EK
9GV8/ XCL85	9LY	11KV8	9DX	12BD6	7BK	12DW7	9A	12K7GT	7R
9JW8/ PCF802	9AE	11LQ8	9EX	12BE3	12GA	12DY8	9JD	12K8	8K
		11LT8	9RL	12BE6	7CH	12DZ6	7BK	12KL8	9LQ
		11MS8	9LY	12BF6	7BT	12EA6	7BK	12LG6T	7AC
9KC6	9RF	11Y9	10L	12BF11	12EZ	12EC8	9FA	12MD8	9RQ
9KX6	9GK	11Y9/ LFL200	10L	12BH7	9A	12ED5	7CV	12Q7GT	7V
9KZ8	9FZ	12A5	7F	12BH7A	9A	12EG6	7CH	12RK19	9CB
9LA6	9GK	12A6	7S	12BK5	9BQ	12EH5	7CV	12S8GT	8CB
9RAL1	9HF	12A7	7K	12BL6	7BK	12EK6	7BK	12SA7	8R
9UA8	8AE	12A8GT	8A	12BN6	7DF	12EK6/ 12DZ6/ 12EA6	7BK	12SA7GT	8AD
10	4D	12AB5	9EU	12BQ6GTB/ 12CU6	6AM	12EL6	7FB	12SC7	8S
10AL11	12BU	12AC6	7BK	12BR3	9CB	12EM6	9HV	12SF5	6AB
10BQ5	9CV	12AC10A	12FE	12BR7	9CF			12SF5GT	6AB
10C8	9DA							12SF7	7AZ
10CW5	9CV	12AD6	7CH	12BS3	9HP	12EN6	7AC	12SG7	8BK
10CW5/ LL86	9CV	12AE6	7BT	12BS3A/ 12DW4A	9HP	12EQ7	9LQ	12SH7	8BK
10DE7	9HF	12AE6A	7BT	12BT3	12BL	12F5GT	5M	12SJT	8N
10DR7	9HF	12AE7	9A	12BV7	9BF	12F8	9FH	12SJ7GT	8N
10DX8	9HX	12AE10	12EZ	12BV7	9BF	12FK6	7BT	12SK7	8N
10DX8/ LCL84	9HX	12AF3/ 12BR3/ 12RK19	9CB	12BV11	12HB	12FM6	7BT	12SK7GT	8N
10EG7	8BD	12B4	9DJ	12BW4	9DJ	12FQ7	9LP	12SL7GT	8BD
10EM7	8BD	12AF6	7BK	12BY7	9BF	12FQ8	9KT	12SN7GT	8BD
		12AH7GT	8BE			12FR8	9KU	12SN7GTA	8BD
						12FV7	9A	12SQ7	8Q
10EW7	9HF	12AJ6	7BT	12BY7A/ 12BV7/ 12DQ7	9BF	12FX5	7CV	12SQ7GT	8Q
10GF7	9QD	12AL5	6BT	12BZ6	7CM	12FX8	9KV	12SR7	8Q
10GF7A	9QD	12AL8	9GS	12BZ7	9A	12FX8A	9KV	12SR7GT	8Q
10GK6	9GK	12AL11	12BU	12C5	7CV	12GA6	7CH	12SW7	8Q
10GN8	9DX	12AQ5	7BZ	12C8	8E	12GB3	6AM	12SX7GT	8BD
10GV8/ LCL85	9LY	12AT6	7BT	12CA5	7CV	12GB6	6AM	12SY7	8R
10HE8	9DX	12AT7/ ECC81	9A	12CL3	9HP	12GB7	6AM	12T10	12EZ
10JA8/ 10LZ8	9DX	12AT7WA 12AT7WB	9A 9A	12CN5	7CV	12GC6	8JX	12U7	7CK
						12GE5	12BJ	12V6GT	7AC
						12GJ5	9QK	12W6GT	7AC
10JT8	9DX	12AU6	7BK	12CR6	7EA	12GJ5A	9QK	12X4	5BS
10JY8	9DX	12AU7	9A	12CT3	9RX	12GN7	9BF	12Z3	6G
10KR8	9DX	12AU7A/ ECC82	9A	12CT8	9DA	12GN7A	9BF	13CW4	12AQ
10KU8	9LT	12AV5GA	6CK	12CU5/ 12C5	7CV	12GT5	9NZ	13DE7	9HF
10LB8	9DX	12AV6	7BT	12CU6	6AM	12GT5A	9NZ	13DR7	9HF
10LE8	9QZ	12AV7	9A	12CX6	7BK	12GW6/ 12DQ6B	6AM	13EM7	8BD
10LW8	9DX	12AW6	7CM	12D4	4CG	12H6	7Q	13EM7/ 15EA7	8BD
10LZ8	9DX	12AX3	12BL	12DB5	9GR	12HE7	12ES	13FD7	9HF
10T10	12EZ	12AX4GT	4CG	12DE8	9HG	12HG7	9BF	13FM7	12EJ
10Z10	12BT								
11	4F	12AX4GTA	4CG	12DK6	7CM	12HG7/ 12GN7A	9BF	13FM7/ 15FM7	12EJ
11AF9	10L	12AX4GTB	4CG	12DK7	9HZ	12HL7	9BF	13GB5	9NH
11AR11	12DM	12AX7	9A	12DL8	9HR	12J5GT	6Q	13GB5/ XL500	9NH
11BM8	9EX	12AX7A/ ECC83	9A	12DM4	4CG	12JGT	7R	13GF7	9QD
11BQ11	12DM	12AY3	9HP	12DM4A	4CG	12JB6	9QL	13GF7A	9QD
11BT11	12GS	12AY7	9A	12DQ6A	6AM	12JB6A	9QL	13J10	12BT
11CA11	12HN			12DQ6B	6AM				
11CF11	12HW			12DQ7	9BF				

Type No.	Terminal Diagram	Type No.	Terminal Diagram	Type No.	Terminal Diagram	Type No.	Terminal Diagram	Type No.	Terminal Diagram
13JZ8	12DZ	17BB14	9NH	18AJ10	12EZ	22BW3	12FX	26	4D
13V10	12EZ	17BE3/		18FW6	7CC	22DE4	4CG	26A6	7BK
13Z10	12BT	17BZ3	12GA	18FW6A	7CC	22JF6	9QL	26A7GT	8BU
13Z10/ 13J10	12BT	17BF11	12EZ	18FX6	7CH	22JG6	9QU	26C6	7BT
14A4	5AC	17BH3	9HP	18FX6A	7CH	22JG6A	9QU	26D6	7CH
14A5	6AA	17BJ6	9QL	18FY6	7BT	22JR6	9QU	26HU5	8NB
14A7	8V	17BQ6GTB	6AM	18FY6A	7BT	22JU6	9QL	26LW6	8NC
14AF7	8AC	17BR3	9CB	18GB5/ LL500	9NH	22KM6	9QL	26LX6	12JA
14B6	8W	17BR3/ 17K19	9CB			22KV6A	9QU	27	5A
						23JS6A	12FY		
14B8	8X	17BS3	9HP	18GD6A	7BK	23JZ8	12DZ	27GB5/ PL500	9NH
14BL11	12GC	17BS3A/ 17DWA4	9HP	18GV8/ PCL85	9LY	23Z9	12GZ		
14BR11	12GL					24A	5E	29KQ6/ PL521	9RJ
14C5	6AA	17BW3	12FX	19	6C	24BF11	12EZ		
14C7	8V	17BZ3	12FX	19AU4	4CG	24JE6A	9QL	29LE6	9RJ
14E6	8W	17C5	7CV	19AU4GTA	4CG	24JZ8	12DZ	30	4D
14E7	8AE	17C9	10F	19BG6G	5BT	24LQ6/ 24JEGC	9QL	30AE3/ PY88	9CB
14F7	8AC	17CK3	9HP	19BG6GA	5BT	24LZ6	9QL	30JZ6	12GD
14F8	8BW	17CT3	9RX	19CG3	12HF				
14GT8	9KR	17CU5/ 17C5	7CV	19CL8A	9FA	25A6	7S	30KD6	12GW
14H7	8V			19DE3	12HX	25A6GT	7S	30MB6	12FY
14J7	8BL	17D4	4CG	19EA8	9AE	25A7GT	8F	31	4D
14JG8	9KR	17DE4	4CG	19EZ8	9KA	25AC5GT	6Q	31AL10	12HR
14N7	8AC	17DM4	4CG	19FX5	7CV	25AV5GA	6CK	31JS6A	12FY
14R7	8AE	17DM4A	4CG	19GQ7	9QM	25AX4GT	4CG	31JS6C	12FY
15	5F	17DQ6A	6AM	19HR6	7BK	25B5	6D	31LQ6	9QL
15AF11	12DP	17DQ6B	6AM	19HS6	7BK	25B6G	7S	31LR8	9QT
15BD11	12DP	17DW4A	9HP	19HV8	9FA	25B8GT	8T	31LZ6	9QL
15BD11A	12DP	17EW8	9AJ	19J6	7BF	25BK5	9BQ	32	4K
15CW5	9CV	17EW8/ HCC85	9AJ	19JN8/ 19CL8A	9FA	25BQ6GT	6AM	32A5	6AA
15CW5/ PL84	9CV	17GB3	6AM	19KG8	9LY	25BQ6GTB/ 25CU6	6AM	32ET5	7CV
15DQ8/ PCL84	9HX	17GE5	12BJ	19MR9	7BK	25C5	7CV	32ET5A	7CV
15FM7		17GJ5	9QK	19T8	9E	25C6G	7AC	32HQ7	12HT
15FY7	12E0	17GJ5A	9QK	19X8	9AK	25CA5	7CV	32LGT6T	8Z
15KY8	9QT	17GT5	9NZ	20	4D	25CD6GA	5BT	33	5K
15KY8A	9QT	17GT5A	9NZ	20AQ3/ LY88	9CB	25CD6GB	5BT	33G7	12FC
15LE8	9QZ	17GV5	12DR	20EQ7	9LQ	25CG3	12HF	33G7A	12FN
15MF8	12DZ	17GW6/ 17DQ6B	6AM	20EZ7	9PG	25CK3	9HP	33JR6	9QU
						25CT3	9RX	33JV6	12FK
16A8/ PCL82	9EX	17H3	9FK	20LF6	12GW	25CU6	6AM	34	4M
16AK9	12GZ	17HB25	17HB25	21EX6	5BT	25DN6	5BT	34CE3	12GK
16AQ3	9CB	17JBG6A	9QL	21GY5	12DR	25E5/ PL36	8GT	34GD5	7CV
16AQ3/ XY88	9CB	17JF6	9QL	21HB5	12BJ	25EC6	5BT	34GD5A	7CV
16BQ11	12DM	17JG6	9QU	21HB5A	12BJ	25EH5	7CV	34R3	9CB
16BX11	12CA	17JG6A	9QU	21HJ5	12FL	25E5H5	7CV	35	5E
16GK6	9GK	17JM6A	12FJ	21JS6A	12FY	25F5A	7CV	35B5	7BZ
16GY5	12DR	17JN6	12FK	21JV6	12FK	25HX5	9SB	35C5	7CV
		17JQ6	9RA	21JZ6	12GD	25JZ8	12DZ	35DZ8	9JE
		17JT6	9QU	21KA6	12GH	25L6	7AC	35EH5	7CV
16LU8A	12DZ	17JT6A	9QU	21KQ6	9RJ	25LG6/ 25W6GT	7AC	35GL6	7FZ
17AB10/ 17X10	12BT	17JZ8	12DZ	21LG6	12HL	25N6G	7W	35L6GT	7AC
17AX3	12BL	17KV6A	9QU	21LG6A	12HL	25N6G	7W	35LR6	12FY
17AX4GT	4CG	17LD8	9QT	21LR8	9QT	25W4GT	4CG	35W4	5BQ
17AX4GTA	4CG	17RK19	9CB	21LU8	12DZ	25W6GT	7AC	35Y4	5AL
17AY3	9HP	17X10	12BT	22	4K	25Y5	6E	35Z4GT	5AA
17AY3A	9HP	17Z3/ PY81	9CB	22BH3	9HP	25Z6	7Q	35Z5GT	6AD
				22BH3A	9HP	25Z6GT	7Q	36	5E

Type No.	Terminal Diagram	Type No.	Terminal Diagram	Type No.	Terminal Diagram	Type No.	Terminal Diagram	Type No.	Terminal Diagram
36AM3	5BQ	i17L7/		5842/		6677/		8058	12CT
36AM3A	5BQ	M7GT	8A0	417A	9V	6CL6	9BV	8077/	
36AM3B	5BQ	117N7GT	8AV	5844	7BF	6678/		7054	9GK
36KD6	12GW	117P7GT	8AV	5847/		6U8A	9AE	8106	9PL
36KD6/		117Z3	4CB	404A	9X	6679/		8136	5C
40KD6	12GW	117Z4GT	5AA	5879	9AD	12AT7	9A	8203	12AQ
36MC6	9QL	117Z6GT	7Q	5881	7S	6680/		8393	12AQ
37	5A	407A	407A	5896	8DJ	12AU7A	9A	8417	7S
38	5F	408A	7BD	5899	8DE	6681/		8532	7BQ
38HE7	12FS	884	6Q2	5902	8DE	12AX7A	9A	8627	12CT
38HK7	12FS	955	5BC	5915	7CH	6688A	9EQ	8628	12AQ
39/44	5F	959	5BE	5963	9A	6814	8DK	8808	8808
40	4D	991	991	5964	7BF	6887	6BT	9002	7BS
40KD6	12GW	1612	7T	5965	9A	6922/		9001	7BD
40KG6A/		1613	7S	6005	7BZ	E88CC	9AJ	9003	7BD
PL509	9RJ	1614	7S	6012	6C0	6939	9HL	9005	5BG
41	6B	1619	7AW	6021	8DG	6973	9EU	9006	6BH
42	6B	1620	7R	6072	9A	6977	6977	A61	4G
42EC4A/		1621	7S	6073	5B0	7025	9A	A863	7R
PY500	6EC4	1622	7S	6073/		7027	8HY	AD17	6AU
42KN6	12GU	1629	7AL	OA2	5B0	7027A	8HY	B36	8BD
43	6B	1635	8B	6074	5B0	7044	9H	B65	8BD
45	4D	2050	6BS	6074/		7054	9GK	B152	9A
45Z3	5AM	2050A	6BS	OB2	5B0	7055	6BT	B309	9A
45Z5GT	6AD	2076/		6080	8BD	7056	7CM	B329	9A
46	5C	5R4GYB	5T	6080WA	8BD	7057	9AJ	B339	9A
47	5B	5636	8DC	6082	8BD	7058	9EP	B719	9AJ
48	6A	5639	8DE	6111	8DG	7059	9AE	B739	9A
49	5C	5642	5642	6112	8DG	7060	9DA	B749	9A
50	4D	5651A	5B0	6186	7BD	7061	9EU	B759	9A
50A5	6AA	5651WA	5B0	6189	9A	7167	7EW	BPM04	7BZ
50B5	7BZ	5654	7BD	6197	9BV	7189	9BL	CXF80	9AE
50BM8/		5663	6CE	6202	5BS	7199	9JT	D2M9	6BT
UCL82	9EX	5670	8CJ	6206	8DC	7247	9A	D63	6BT
50C5	7CV	5672	5672	6211	9A	7258	9DA	D152	6BT
50C6G	7AC	5678	5678	6336A	8BD	7308	9AJ	DA90	5AP
50DC4	5BQ	5686	9G	6350	9CZ	7355	8KN	DAF91	6AU
50EH5	7CV	5687	9H	6360A	6360A	7360	9KS	DAF92	6BW
50FE5	8KB	5691	8BD	6386	8CJ	7408	7AC	DF33	5Y
50FK5	7CV	5692	8BD	6417	9K	7543	7BK	DF91	6AR
50GY7A	12FN	5693	8N	6485	5C	7551	9LK	DF904	6AR
50HC6	7FZ	5696	7BN	6550	7S	7558	9LK	DH63	7V
50HK6	7FZ	5696A	7BN	6626/		7581A	7AC	DH77	7BT
50JY6	8MG	5718	8DK	OA2WA	5B0	7586	12AQ	DK91	7AT
50L6GT	7AC	5719	8DK	6660/		7587	12AS	DL012	9E
50X6	7DX	5725	7CM	6BA6	7BK	7591	8KQ	DL31	6X
50Y6GT	7Q	5726	6BT	6661/		7591A	8KQ	DL33	7AP
50Y7GT	8AN	5727	7BN	6BH6	7CM	7695	9PX	DL91	7AV
50Z7G	8AN	5734	5734	6662/		7717/		DL92	7BA
53	7B	5749	7BK	6BJ6	7CM	6CY5	7EW	DL94	6BX
53HK7	12FS	5750	7CH	6663/		7724/		DL95	7BA
60FX5	7CV	5751	9A	6AL5	6BT	14GT8	9KR	DP61	7BD
70L7GT	8AA	5763	9K	6664/		7868	9NZ	DY30	3C
75	6G	5783	5783	6AB4	5CE	7895	12AQ	DY80	9Y
78	6F	5814A	9A	6669/		7898	9EP	DY87	9DT
80	4C	5823	4CK	6AQ5A	7BZ	7905	9PB	E81CC	9A
83	4C	5824	7S	6676/		8016	3C	E82CC	9A
84/6Z4	5D	5840	8DE	6CB6A	7CM	8056	12AQ	E83CC	9A

TERMINAL DIAGRAM DESIGNATIONS

Type No.	Terminal Diagram	Type No.	Terminal Diagram	Type No.	Terminal Diagram	Type No.	Terminal Diagram	Type No.	Terminal Diagram
EEA91	6BT	EF190	7CM	KT77	8N	OC2	5B0	U70	5AA
EABC80	9E	EF811	9AQ	KT81	6AA	OC3	4AJ	U74	5AA
EB34	7Q	EF814	9AQ	KT88	8EP	OC3A	4AJ	U76	5BS
EB91	6BT	EF905	7BD	KTW63	7R	OD3	4AJ	U78	5BS
EBC90	7BT	EFL200	10L	KT263	7R	OD3A	4AJ	U707	5DA
EBC91	7BT	EFL201	10L	L63	6Q	OSW3104	8R	U709	9M
EBF85	9HE	EH90	7CH	L63B	6Q	OSW3105	8Q	UCL82	9EX
EBF89	9HE	EK90	7CH	L77	6BG	OSW3106	7AC	UCL83	9EX
EC88	9NY	EL22	6AA	LC900	7GM	OSW3110	6R	UU12	9M
EC90	6BG	EL34	8ET	LCF80	9DC	OSW3111	8N	V153	4G
EC92	5CE	EL37	7AC	LCF86	9MP	OZ4	4R	V741	6BG
EC94	7DK	EL84	9CV	LCF201	10K	OZ4A	4R	VSM70	5BS
EC95	7FP	EL86	9CV	LCF801	9QA	OZ4G	4R	W17	6R
EC97	7FP	EL90	7BZ	LCF802	9AE	PC95	7FP	W61	7AR
EC900	7GM	EL95	7DQ	LCL82	9EX	PC900	7GM	W63	7R
ECC32	8BD	EL180	9BF	LCL84	9HX	PCC18	9A	W81	8V
ECC35	8BD	EL500	9NH	LCL85	9LY	PCC85	9AJ	W143	8V
ECC81	9A	EL509	9RJ	LF183	9AQ	PCF80	9DC	W148	8V
ECC82	9A	EM35	6R	LF184	9AQ	PCF82	9DX	W727	7BK
ECC83	9A	EM84	9GA	LF200	10L	PCF86	9MP	X17	7AT
ECC85	9AJ	EM87	9GA	LFL200	10L	PCF801	9QA	X63	8A
ECC88	9AJ	EM840	7S	LL86	9CV	PCF802	9AE	X77	7CH
ECC89	9DE	EY81F	9BD	LL500	9NH	PCL82	9EX	X107	6CH
ECC91	7BF	EY88	9CB	LN119	9EX	PCL84	9HX	X150	12BQ
ECC180	9AJ	EY500	6EC4	LY88	9CB	PCL85	9LY	X727	7CH
ECC186	9A	EZ4	9M	LZ319	9DC	PCL800	9GK	XC95	7FP
ECC189	9AJ	EZ35	6S	LZ329	9DC	PH4	8A	XC97	7FP
ECC801	9A	EZ90	5BS	M709	9CV	PL36	8GT	XC900	7GM
ECC802	9A	EZ900	5BS	M8080	6BG	PL84	9CV	XCC82	9A
ECC803	9A	GZ30	5T	M8081	7BF	PL500	9NH	XCC189	9AJ
ECF80	9DC	GZ32	5DA	M8108	7BK	PL509	9RJ	XCF80	9DC
ECF82	9AE	GZ34	5DA	M8136	9A	PL521	9RJ	XCF801	9QA
ECF86	9MP	GZ37	5DA	M8137	9A	PM04	7BK	XL85	9LY
ECF200	10K	H63	5M	M8162	9A	PM05	7BD	XF94	7BK
ECF201	10K	HAA91	6BT	M8245	7BZ	PY81	4G	XF183	9AQ
ECF801	9QA	HBC90	7BT	N16	7AP	PY83	4G	XF184	9AQ
ECF802	9AE	HBC91	7BT	N17	7BA	PY88	4G	9CV	XL84
ECH42	12BQ	HCC85	9AJ	N18	7BA	PY500	6EC4	XL86	9CV
ECL82	9EX	HD14	5Z	N19	6BX	PY800	4G	XL500	9NH
ECL84	9HX	HD94	6AM	N63	7S	QA2401	6BG	XXA-91	6BT
ECL85	9LY	HD96	6AM	N148	6AA	QA2404	6BT	XY88	9CB
ECL86	9LZ	HF93	7BK	N308	8GT	QA2406	9A	Y61	6R
ECL180	8CK	HF94	7BK	N369	9EX	QB309	9A	YC95	7FP
EF22	8V	HK90	7CH	N727	7BZ	QL77	6BG	YCC189	9AJ
EF37	7R	HL92	7CV	OA2	5B0	R-19	9Y	YCL180	9AJ
EF80	9FN	HM04	7CH	OA2WA	5B0	R-52	5DA	YF183	9AQ
EF93	7BK	HY90	5BQ	OA3	4AJ	RJ2	5T	YF184	9AQ
EF94	7BK	HZ90	5BS	OA3A	4AJ	T2M05	7BF	Z14	5Y
EF95	7BD	KT-32	7AC	OA4G	4V	U41	3C	Z63	7R
EF96	7BD	KT-63	7S	OB2	5B0	U50	5T		
EF183	9AQ	KT66	7AC	OB2WA	5B0	U52	5T		
EF184	9AQ	KT71	7AC	OBC3	8Q	U54	5DA		

III. TERMINAL CONNECTIONS

This chart gives the pin or terminal connections for each terminal diagram designation referred to in this manual. The following tabulation gives the meaning of each of

the symbols, letter combinations or subscripts, used in this chart and on the basing diagrams in the Technical Data Section.

LETTER COMBINATIONS

DJ_A = Deflecting Electrode A
 DJ_B = Deflecting Electrode B
 F = Filament End (Unpolarized)
 F^+ = Filament End (Positive only)
 F^- = Filament End (Negative only)
 F_M = Filament Tap
 G = Grid
 $G_1, G_2, \text{etc.}$ = Grid No.1, Grid No.2, etc.
 H = Heater End (Unpolarized)

H_A = Heater End A
 H_B = Heater End B
 HI = Heater Insulator
 H_M = Heater Tap
 IC = Do Not Use
 IS = Internal Shield (Electrostatic)
 JPR = Jumper End
 K = Cathode
 LC = May be used only under Limited Conditions
 NC = No Internal Connection
 NC G = No Base Connection, glass tube

P = $\left\{ \begin{array}{l} \text{Plate (Vacuum tubes)} \\ \text{Anode (Gas-filled tubes)} \end{array} \right.$
 P_A = Plate A
 P_B = Plate B
 RCJ = Ray-Control Electrode
 REM = Remote
 S = Metal Shell
 SM = Shell connection, metal tube
 SHP = Sharp Starter
 STR = Starter
 TC = Fluorescent Target
 TA = Top Cap
 * = Gas Filled

SUBSCRIPTS FOR MULTIUNIT TYPES

B = Beam Power Unit
 D = Diode Unit
 HP = Heptode Unit

HX = Hexode Unit
 P = Pentode Unit
 T = Triode Unit

TR = Tetrode Unit
 1, 2, 3, etc. = No. 1, No. 2, No. 3, etc.

Please note that the terminal diagrams given in the Technical Data Section are bottom views of the tube base and that the pins or terminals are numbered clockwise. For essentially all modern tubes the spacing between pin No. 1 and the pin having the highest number is somewhat larger than the spacing

between all the other pins. For octal based types, the "key" for orienting the tube when it is inserted in a socket also serves to designate pin No. 1, which is the first pin clockwise from the key. The following diagrams illustrate the terminal configuration of receiving tubes most commonly encountered.

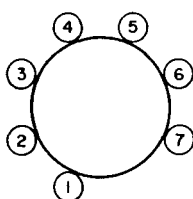

7-Pin

Miniature

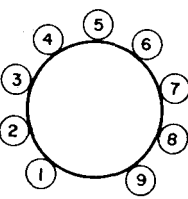

9-Pin

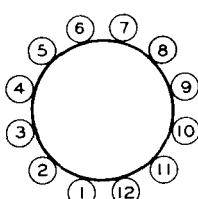

Duodecar

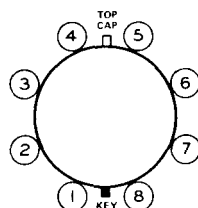

Octal

Terminal Diagram	PIN NUMBER												TC		
	1	2	3	4	5	6	7	8	9	10	11	12			
1AY2	F	F													P
3C	LC	F	LC	LC	LC	LC	F,IS	LC							P
4AA*	F	P	NC	NC	IC	G	NC	F							
4AJ*	NC	K	JPR		P		JPR	NC							
4C	PD2	PD1	F	F											
4CB	IC	NC	H	H	P	K	NC								
4CG	IC	IC	K		P		H	H							
4CK*	P	IC	K	STR	IC	IC	K								
4D	F	P	G	F											
4F	F	P	F	G											
4G	H	P	K	H											
4K	F	P	G2	F											G1
4M	F+	P	G2	F-,G3											G1
4R*	S	NC	P2		P1		NC	K							
4V*	NC	K	NC		P		STR	NC							
4Z	H	P	NC	NC	NC	NC	K	H							
5A	H	P	G	K	H										
5AA	NC	H	NC		P		H	K							
5AB	H	NC	PD2	NC	NC	PD1	K	H							
5AC	H	P	NC	NC	NC	G	K	H							
5AD	F+	P	G2	NC	NC	G1	NC	F-,G3							
5AG	F+,IS	PT	NC	PD	NC	GT	NC	F-							
5AL	H	P	NC	HM	NC	NC	K	H							
5AM	H	P	IC	K	NC	P	H								
5AP	H	P	K	NC	IC	P	H								
5AY	G	NC	H	H	K	NC	P								
5B	F	P	G1	G2	F										
5BC	H	P	G	H	K										
5BE	F+	G2	G3	F-	F-										

TOP LEAD P
BOT LEAD G1

Terminal Diagram	PIN NUMBER												
	1	2	3	4	5	6	7	8	9	10	11	12	TC
5BG	HB	K	P	HA	HA								
5B0*	P	K	IC	K	P	IC	K						
5BQ	NC	NC	H	H	P	HL	K						
5BS	PD2	NC	H	H	NC	PD1	K						
5BT	NC	H	K,G3	NC	G1	NC	H	G2					P
5C	F	P	G1	G2	F								
5CE	P	NC	H	H	NC	G	K						
5D	H	PD2	PD1	K	H								
5DA	IC	H	PD2	PD1	H,K								
5DE	F	IC	F		PD2		PD1						
5E	H	P	G2	K	H								G1
5F	H	P	G2	K,G3	H								G1
5K	F+	P	G1	G2	F-,G3								
5L	NC	H		PD2		PD1	H,K						
5M	NC G S M	H	NC	P	NC		H	K					G
5Q	NC	NC	PD2	NC	PD1	NC	F	F					
5R	NC	F	P	G2	NC		F	NC					G1
5S	NC	F	P	NC	G	NC	F	NC					
5T	NC G S M	F		PD2		PD1		F					
5U		H	P		NC		H	K					G1
5Y	BC	F+	P	G2	NC		F-,IS G3	NC					G1
5Z	BC	F+	PT	NC	PD		F-	NC					GT
6A	H	P	G2	G1	K	H							
6AA	H	P	G2	NC	NC	G1	K,G3	H					
6AB	NC G S M	K	G		P		H	H					
6AD	NC	H	HM		P		H	K					
6AE	H	P	G2	NC	NC	G1	K,G3	H					

Terminal Diagram	PIN NUMBER												TC
	1	2	3	4	5	6	7	8	9	10	11	12	
6AF	NC	F+	P	G2	G1		F-,G3	NC					
6AM	NC	H	NC	G2	G1		H	K,G3					P
6AR	F-,IS G3	P	G2	NC	F-,IS G3	G1	F+						
6AS	H	PT2	PT1	GT1	K	H							
6AU	F-, G3P	NC	PD	G2P	PP	G1P	F+						
6AX	F+	PP	G2P	PD	NC	G1P	NC	F-, G3P					
6B	H	P	G2	G1	K G3	H							
6BA	F+	P	G2	NC	NC	G1	FM G3	F-					
6BG	P	IC	H	H	P	G	K						
6BH	P	K	H	H	P	NC	K						
6BS*		H	P	NC	G1	G2	H	K					
6BT	KD2	PD1	H	H	KD1	IS	PD2						
6BW	F-, G3P	PP	G2P	PD	NC	G1P	F+						
6BX	F-	P	G2	NC	FM,G3	G1	F+						
6C	F	PT2	GT2	GT1	PT1	F							
6CC	G1	G3,K	H	H	P	G2	NC						
6CE*	G1	K	H	H	G2	NC	P						
6CK	G1	H	G3,K		P		H	G2					
6CN	KD2	H	IC	PD2	PD1		H	KD1					
6CO*	K	H	G1		P		H	G2					
6D	H	PT2	PT1	GT1	K	H							
6E	H	PD2	KD2	KD1	PD1	H							
6EC4	IC	P	HI	H	H	IC	P	P	IC				K
6F	H	P	G2	G3	K,IS	H							G1
6G	H	PT	PD2	PD1	K	H							G1
6J	H	ES	PD2	K	PD1	H							

Terminal Diagram	PIN NUMBER												
	1	2	3	4	5	6	7	8	9	10	11	12	TC
6K	HM	H	PD2	K	PD1	H							
6L	F	P	G2	G1	G3,G5	F							G4
6M	F	PT	PD2	PD1	GT	F							
6Q	NC S	G M	H	P		G		H	K				
6R	H	PT RCJ	GT	TA	K	H							
6S	NC S	G M	H	PD2		PD1		H	K				
6W	F+	PP	G2P	PD2	PD1	F— G3P							G1P
6X	NC	F+	P	G2	G1		F—,G3						
7AA	NC	F+	PT	PD2	PD1	GT	F—	NC					
7AB	NC	F	PT2	GT2	GT1	PT1	F	NC					
7AC	NC S	G M	H	P	G2	G1		H	K	G3			
7AF	NC	F+	PP	PD2	PD1	G2P	F— G3P	NC					G1P
7AG	NC	H	RCJB	RCJA	TA		H	K					
7AH	NC	H	PT REM	PT SHP	G		H	K					
7AJ	H	KD2	PD2	NC	IS	PD1	KD1	H					
7AK	F	P	G2	G1	G3,G5	G4	NC	F					
7AL	NC	H	PT RCJ	TA	GT		H	K					
7AM	NC	F+	PP	G2P	G1P	PD	F— G3P	NC					
7AO	F+	P	G2	G3	F—,IS	G1	NC	F—,IS					
7AP	NC	F+	P	G2	G1		F—	G3,FM					
7AQ	NC	F	P	G2	G1		F	FM,G3					
7AT	F—,G5	P	G2,G4	G1	F—,G5	G3	F+						
7AU	NC	H	PT2	PT1	GT1		H	K					
7AV	F—,G3	P	G1	G2	F—,G3	P	F+						

Terminal Diagram	PIN NUMBER												
	1	2	3	4	5	6	7	8	9	10	11	12	TC
7DQ	G1	K,G3	H	H	P	G2	G1						
7DX	H	KD2	PD2	NC	NC	PD1	KD1	H					
7E	H	PP	G2P	PT	GT	K,G3P	H						G1P
7EA	K,G3P	PD	H	H	PP	G2P	G1P						
7EG	K	G	H	H	P	K	G						
7EK	K	G2	H	H	G1	G1	P						
7EN	G1	K,IS	H	H	P	G2	G3						
7EW	G1	K,IS	H	H	P	G2	K,IS						
7F	H	P	G2	G1	K,G3	HM	H						
7FB	GT	PT	H	H	PD2	PD1	K						
7FL	NC	PD2	H	H	K	IS	PD1						
7FP	K	G2	H	H	P	IS	K						
7FQ	G1	IS	H	H	P	G2	K						
7FZ	K,G3	G1	H	H	G2	HM	P						
7G	H	PT	ES	PD2	PD1	K	H						G1T
7GA	G1	K,G2 G4	H	H	P	G3	K,G2 G4						
7GM	G1	K	H	H	P	IS	K						
7H	H	P	G2	G3	ES	K	H						G1
7K	H	PP	G2P	KD	PD	KP G3P	H						G1P
7Q	NC S	G M	H	PD2	KD2	PD1	H	KD1					
7R	NC S	G M	H	P	G2	G3	H	K IS					
7S	NC S	G M	H	P	G2	G1	H	K G3					
7T	NC S	G M	H	P	G2 G4	G3	H	K G5					G1
7U	NC	H	H	PP	G2P	PT	G1	K,G3P					G1P
7V	NC	H	PT	PD2	PD1		H	K					GT

Terminal Diagram	PIN NUMBER												TC	
	1	2	3	4	5	6	7	8	9	10	11	12		
7W	NC	H	PT2	PT1	GT1		H	K						
7Z	BC	F	P	G3,G5	G1	G2	F	NC						G4
8A	NC S	G M	H	P	G3 G5	G1	G2	H	K					G4
8AA	KD	H	PB	G2B	G1B	KB G3B	H	PD						
8AC	H	KT2	PT2	GT2	GT1	PT1	KT1	H						
8AD	NC	H	P	G2,G4	G1	K,G5	H	G3						
8AE	H	PP	PD2	PD1	G2P	G1P	K,G3P	H						
8AJ	NC	F+	PP	G2P	G1P	PT	F— G3P	PD						GT
8AL	H	P	G2,G4	G1	G5	G3	K	H						
8AN	NC	H	PD2	KD2	PD1	HM	H	KD1						
8AO	KD	H	PB	G1B	G2B	PD	H	KB G3B						
8AS	FM,IS G3P	F	PP	G2P	GT	PT	F—	PD						GT
8AV	NC	H	PB	G1B	G2B	KB G3B	PD H	KD						
8AY	GT	H	PP	G2P	G1P	PT	H	K,G3P						
8B	NC S	G M	H	PT2	GT2	GT1	PT1	H	K					
8BD	GT2	PT2	KT2	GT1	PT1	KT1	H	H						
8BE	GT2	KT2	PT2	KT1	GT1	PT1	H	H						
8BF	H	KT	PT	GT	PD2	PD1	KD1 KD2	H						
8BJ	H	P	G2	K	IS,G3	G1	K	H						
8BK	S	H	K,G3	G1	K,G3	G2	H	P						
8BL	H	PHP	PT	GT G3HP	G2HP G4HP	G1HP	K,IS G5HP	H						
8BU	G1B1	K G3B1 G3B2	G1B2	PB2	G2B1 G2B2	H	H	PB1						
8BW	GT2	H	PT2	KT2	KT1	PT1	H	GT1						

Terminal Diagram	PIN NUMBER												
	1	2	3	4	5	6	7	8	9	10	11	12	TC
8BZ	H	PT2	G1	KT, IS KD1	PD1	PD2	KD2	H					
8C	NC	F+	PP2	G1P2	G1P1	PP1	F-, G3	G2					
8CB	PD3	KT KD2 KD3	PD1	PD2	KD1	PT	H	H					GT
8CH	G	H	TA	DJ2	DJ3	DJ1	H	K					
8CJ	H	KT2	GT2	PT2	IS	PT1	GT1	KT1	H				
8CK	PD2	KD1 KD2	PD1	GT	PT	KT	H	H					
8CN	IC	G1	NC	F-, G5	F+	P	G2, G4	G3					
8CP	NC	G1	NC	F-, G3	F+	NC	P	G2					
8CT	G2, G4	G1	K	H	H	G5, IS	G3	IS	P				
8DA	PP	NC	G1P	F-, G3P	F+	PD	NC	G2P					
8DC	G1	K, IS	H	G3	P	H	G2	K, IS					
8DE	G1	K, G3	H	K, G3	P	H	G2	K, G3					
8DG	PT2	GT2	H	KT2	KT1	H	GT1	PT1					
8DJ	PD2	KD2	H	IS	PD1	H	KD1	NC					
8DK	G	NC	H	NC	K	H	NC	P					
8E	BC	H	PP	PD2	PD1	G2P	H	K, G3P					G1P
8EL	G	H	NC		P		H	K					
8EP	G3	H	P	G2	G1	NC	H	K					
8ET	G3	H	P	G2	G1	NC	H	K					
8EZ	LC	H	LC		LC		H, K IS						P
8F	KD	H	PP	G2P	G1P	PD	H	KP G3P					
8FU	K	H	NC		NC		H	NC					P
8G	NC	H	PT2	KT2	GT1	PT1	H	KT1					GT2
8GB	IC	IC	K	IC	P	IC	H	H					
8GC	K	H	IC	IC	G	IC	H	IC					P

Terminat Diagram	PIN NUMBER												TC	
	1	2	3	4	5	6	7	8	9	10	11	12		
8GD	G2	H	G3,K	G1	G1	G3,K	H	G2						P
8GH	LC	H	LC	LC	LC	LC	H,K IS	LC						P
8GT	IC	H	IC	G2	G1		H	K,G3						P
8H	NC	H	PHP	G2HP G4HP	GT G3HP	PT	H	K G5HP						G1HP
8HY	G2	H	P	G2	G1	G1	H	K,G3						
8JB	G	H	G		P		H	K						
8JC	G1	H	G3,K	G2	G1	G3,K	H	G2						P
8JP	G1P2	H	PP2	G2	G1P1	PP1	H	K,G3						
8JX		H	K,G3	G2	G1		H	G2						P
8K	S	H	PHX	G2HX G4HX	GT G1HX	PT	H	K						G3HX
8KB		H	P	G2	G1	H	K,G3							
8KN		H	P		G3,K	G1	H	G2						
8KQ		H	P	G2	G3,K	G1	H	G2						
8KS	F	F	PD2	PD2	PD1	PD1	F	F						
8LY	P	H	P	G2	G1		H	K,G3						
8MG	IS	H	G3	G2	G1	NC	H	K						P
8MH	LC	H	LC		LC		H,K IS	LC						P
8MK	IC	F	IC		IC		F,IS	IC						P
8ML	IS	H	IC	IC	G	K	H	IC						P
8MQ	IC	H	IS	IC	G	K	H	IC						P
8MT	NC	IC	H	IC	IC	IC	NC	H,K IS						P
8MU	IC	H	IC	NC	IC	NC	H,K IS	IC						P
8MW	K,IS	H	IC	IC	G	NC	H	IC						P
8MX	H,K IS	H	IC	NC	IC	NC	H,K IS	IC						P
8MY	NC	IC	H	IC	H	IC	NC	H						P
8MZ	F,IS	F	F,IS	NC	F,IS	NC	F,IS	NC						P
8N	S	H	G3	G1	K	G2	H	P						
8NB	G1	K,G3	G2	NC	G1	IC	H	H						P

Terminal Diagram	PIN NUMBER												TC
	1	2	3	4	5	6	7	8	9	10	11	12	
8NC	IC	K,G3	G2	NC	G1	IC	H	H					P
8ND	NC	IC	F	IC	F	IC	NC	F,IS					P
8NJ	K,IS	H	IC	IC	G	G	H	IC					P
8NL	IC	H,K IS	H	NC	H	H,K IS	NC	H,K IS					P
8NP	IC	IC	H	IS	IS	G	K	H					P
8Q	S	GT	K	PD2	PD1	PT	H	H					
8R	S,G5	H	P	G2,G4	G1	K	H	G3					
8S	S	PT2	GT2	GT1	PT1	K	H	H					
8T	KP G3P	H	PP	G2P	PT	KT	H	GT					G1P
8U	H	P	G2	G1	G3,G5	G4	K,G6	H					
8V	H	P	G2	G3	IS	G1	K	H					
8W	H	PT	GT	IC	PD2	PD1	IS,K	H					
8X	H	P	G2	G1	G3,G5	G4	K	H					
8Y	G3,S	H	NC	G1	K	G2	H	P					
8Z	KD	H	PB	G2B	G1B	PD	H	KB G3B					
9A	PT2	GT2	KT2	HT2	HT1	PT1	GT1	KT1	HM				
9AC	IC	K	G	H	H	G	IC	IC	P				
9AD	G1	NC	K	H	H	NC	G2	P	G3				
9AE	PT	G1P	G2P	H	H	PP	KP,IS G3P	KT	GT				
9AG	K	G	HM	H	H	NC	G	NC	P				
9AJ	PT2	GT2	KT2	H	H	PT1	GT1	KT1	IS				
9AK	G3P	GT	PT	H	H	K	G1P	G2P	PP				
9AQ	K	G1	K	H	H	IS	P	G2	G3				
9AU	IS	G1	K	H	H	IS	P	G2	G3				
9AX	KD3	PD3	IS	H	H	PD2	KD2	PD1	KD1				
9BD	NC	P	NC	H	H	NC	P	NC	P				K
9BF	K	G1	G3,IS	H	H	HM	P	G2	G3,IS				
9BL	IC	G1	K,G3	H	H	IC	P	IC	G2				
9BQ	P	NC	G1	H	H	K,G3	G1	G2	NC				
9BV	K	G1	G2	H	H	P	G3,IS	G2	G1				

Terminal Diagram	PIN NUMBER													TC		
	1	2	3	4	5	6	7	8	9	10	11	12				
9BX	G	K	G	G	P	G	H	H	G							
9CA	G2HP G4HP	G1HP	K G5HP	H	H	PHP	G3HP	PT	GT							
9CB	IC	IC	IC	H	H	IC	IC	IC	P							K
9CF	PT	GT	KT	H	H	PD2	PD1	KD1 KD2 IS	HM							
9CK	G2	NC	G1	H	H	G1	K,G3	NC	P							
9CV	IC	G1	K,G3	H	H	IC	P	IC	G2							
9CY	KP	G1P	G2P	H	H	PP	KD	PD	G3P IS							
9CZ	PT2	KT2	GT2	H	H	PT1	KT1	GT1	HM							
9DA	PT	GT	KT	H	H	PP	G2P	G1P	G3P KP,IS							
9DC	PT	G1P	G2P	H	H	PP	KP,IS G3P	KT	GT							
9DE	PT2	GT2	KT2	H	H	PT1	GT1	KT1	IS							
9DJ	PD2	NC	NC	H	H	NC	PD1	NC	K							
9DP	DJ2	DJ1	G3	HB	HA,IS G2	G1	K	P2	P1							
9DR	P	G	G	H	H	K	G	G	P							
9DS	G2P	G1P	KP	H	H	PD	G3P IS	KD	PD							
9DT	H,K IS	H	NC	H,K IS	H	H,K IS	NC	H	H,K IS							P
9DW	GT	PT	K	H	H	PP	G2P	G3P	G1P							
9DX	KT	GT	PT	H	H	G3P KP,IS	G1P	G2P	PP							
9DZ	KT	GT	PT	H	H	G1P	G3P KP,IS	G2P	PP							
9E	PD3	PD2	KD2 IS	H	H	PD1	KT,IS KD1 KD3	GT	PT							
9EC	G3P KT,IS	GT	PT	H	H	G1P	KP	G2B	PP							
9ED	PP	G2P	KP	H	H,IS G3P	G1P	KT	PT	GT							
9EF	PT2	NC	GT2	H	H	PT1	GT1	KT1	KT2							

Terminal
Diagram

PIN NUMBER

	1	2	3	4	5	6	7	8	9	10	11	12	TC
9EG	GT	PT	KT, IS G3P	H	H	PP	G2P	KP	G1P				
9EN	PD2	PD1	KD1 KD2 IS	H	H	KT	GT	PT	HM				
9EP	PT2	GT2	KT2	H	H	PT1	GT1	KT1	IC				
9EQ	K	G1	K	H	H	IC	P	G3	G2				
9ER	PD2	KD2	KD1	H	H	PD1	PT	GT	KT				
9ES	PT2	NC	KT1	H	H	PT1	GT1	GT2	KT2				
9EU	G2	NC	G1	H	H	G1	K, G3	G2	P				
9EX	GT	KP, IS G3P	G1P	H	H	PP	G2P	KT	PT				
9FA	GT	PT	KT	H	H	PP	G2P	KP, IS G3P	G1P				
9FE	PD2	PD1	KD1 KD2	H	H	PP	G2P	G1P	KP G3P				
9FG	K	G2, IS	PP2	H	H	G3P2	G1	PP1	G3P1				
9FH	PD2	GP2	PP	H	H	PD1	K	G1P	G3P				
9FJ	KT	GT	PT	H	H	PD2	KD1	KD2	PD1				
9FK	K	IC	P	H	H	IC	IC	P	IC				
9FN	G1P	G3P IS	KD	H	H	PD	PP	G2P	KP				
9FT	KT	PP	G2P	H	H, IS G3P	KP	G1P	GT	PT				
9FX	GT	PT	KT	H	H	PTR	G2TR	KTR IS	G1TR				
9FZ	PT	G1P	KP, IS G3P	H	H	PP	G2P	KT	GT				
9G	K, G3	G1	K, G3	H	H	G2	P	K, G3	G2				
9GA	GT	IC	K	H	H	TA	RCJ	IC	PT				
9GC	G1TR	KTR	G2TR	H	H	PTR	KD1 KD2	PD2	PD1				
9GE	PT	G1TR	G2TR	H	H	PTR	KTR IS	KT	GT				
9GF	GT	PT	K	H	H	PP	G2P	G3P, K	G1P				

Terminal Diagram	PIN NUMBER												TC
	1	2	3	4	5	6	7	8	9	10	11	12	
9GK	K	G1	G3,IS	H	H	NC	P	G2	G3,IS				
9GM	KT,IS G3P	PP	G2P	H	H	KP	G1P	GT	PT				
9GR	G2	K,G3	G1	H	H	G1	K,G3	IC	P				
9GS	PT	G2TR	G1TR	H	H	PTR	KTR	GT	KT				
9H	PT2	GT2	KT2	H	H	KT1	GT1	HM	PT1				
9HE	G2P	G1P	K,IS	H	H	PP	PD1	PD2	G3P				
9HF	PT2	GT2	GT2	H	H	PT1	GT1	KT1	KT2				
9HG	G1P	KD	PD	H	H	PP	GP3 IS	G2P	KP				
9HK	PD2	KD1 KD2	PD1	H	H	G1P	KP,IS G3P	G2P	PP				
9HL	G1P2	K,G3	G1P1	HP2	HP1	PP2	G2	PP1	HM				
9HN	G2	NC	G1	H	H	G1	K,G3	IC	P				
9HP	IC	P	IC	H	H	IC	P	IC	K				
9HR	PD2	KTR	G1TR	H	H	PTR	G2TR	KD1 KD2 IS	PD1				
9HV	G1TR	K	G2TR	H	H	PTR	IC	IC	PD				
9HX	GT	PT	KT	H	H	PP	KP,IS G3P	G1P	G2P				
9HZ	G1TR	K	G2TR	H	H	PD2	PTR	KTR	PD1				
9JD	G1TR	KTR	G2TR	H	H	PTR	KT,IS	PT	GT				
9JE	GT	KP,IS G3P	G1P	H	H	PP	G2P	KT	PT				
9JF	PP	GT	PT	H	H	KT	G1P	KP,IS G3P	G2P				
9JG	K,IS G3P	GT	PT	H	H	K,IS G3P	G1P	G2P	PP				
9JT	PT	PP	G2P	H	H	KP,IS G3P	G1P	KT	GT				
9JU	PD2	NC	G1TR	H	H	PTR	G2TR	K	PD1				
9K	P	NC	G3	H	H	G2	K	G1	G1				

Terminal Diagram	PIN NUMBER												
	1	2	3	4	5	6	7	8	9	10	11	12	TC
9KA	KT3	GT3	PT3	H KT1 KT2	H	PT2	GT2	PT1	GT1				
9JX	G1TR	K	G2TR	H	H	PTR	PD2	IC	PD1				
9KP	P1BTR	GT	PT	H,K	H	G1TR	G2TR	P1ATR	P2TR				
9KR	KD2	PD1	KD1	H	H	PD2	KT	GT	PT				
9KS	K,IS	G2	G1	H	H	PB	PA	DJB	DJA				
9XT	2PB	2G	2PA	H	H	1PB	1G	1PA	K				
9KU	GT	KT	G1P	H	H,G3P KP,IS	G2P	PP	PD	PT				
9KV	G2 G4HP	G1HP	PHP	H	H KT	GT	G5HP KHP IS	PT	G3HP				
9LG	PT2	IC	GT2	H	H	PT1	GT1	KT1	KT2				
9LK	K	G1	G2	H	H	P	G3	G2	K				
9LP	PT2	GT2	KT2	H	H	PT1	GT1	KT	NC				
9LQ	G3P	G1P	K	H	H	G2P	PP	PD	IS				
9LS	H	H	NC	KT2	GT2	PT2	PT1	GT1	KT1				
9LT	KD1 KD2 ISD	PD2	PD1	H	H	KP G3P ISP	G1P	G2P	PP				
9LW	K IS	G2	PP2	H	H	G3P2	G1	PP1	G3P1				
9LY	PT	GT	KT	H	H	PP	G2	KP G3P	G1P				
9LZ	GT	KT	G2P	H	H	PP	KP,IS G3P	G1P	PT				
9M	PD1	NC	K	H	H	NC	PD2	NC	NC				
9MB	GT3	PT3	GT2	H,GT1 KT3	H	PT1	KT1	KT2	PT2				
9MP	KP	G1P	KT,IS	H	H	GT	PT	PP	G2P				
9MQ	G2	IC	IC	H	H	G1	K,G3	IC	P				
9MR	PBTR	NC	PD	H	H	K,IS	G1TR	G2TR	PATR				
9NH	G1	G1	G3,K	H	H	G2	G2	G3,K	IC				P

Terminal Diagram	PIN NUMBER												TC
	1	2	3	4	5	6	7	8	9	10	11	12	
9NJ	G1P1	G2P1	PP1	H	H	G1P2	K,IS G3	PP2	G2P2				
9NX	K	G1	K	H	H	G2	P	G3, IS	G2				
9NW	K	G1	G3	H	H	G2	P	G2	G3				
9NY	G	K	G	H	H	G	G	P	G				
9NZ	G2	G1	K,G3	H	H	G1	G2	IC	P				
9PA	K,IS G3P	G1P	G2P	H	H	PP	K,IS G3P	GT	PT				
9PB	F-	G1	G2	LC	LC	P	G3	G2	F+				
9PG	H	H	IC	KT2	GT2	PT2	PT1	GT1	KT1				
9PL	P	K,G3	G2	H	H	K,G3	G1	G2	K,G3				
9PM	K	G1	K	H	H	NC	P	G2	G3,IS				
9PQ	PD4	PD3 KD4	KD3	H	H	IS	PD2	PD1 KD2	KD1				
9PV	PT	GT	K,IS	H	H	G1P	G3P	G2P	PP				
9PX	G2	NC	IC	H	H	G1	K,G3	IC	P				
9PZ	P	G3	G2	H	H	G3	K	G1	K				
9QA	K,IS G3P	G1P	K,IS G3P	H	H	PP	G2P	PT	GT				
9QD	KT1	GT2	KT2	H	H	PT2	NC	PT1	GT1				
9QG	PIBTR	PIATR	PD	H	H	K,IS	G1TR	G2TR	P2TR				
9QJ	FB	FA	FA	LC	PD2	PD2	LC	PD1	PD1				
9QK	G2	G1	K,G3	H	H	G1	G2	IC	IC				P
9QL	G2	G1	K	H	H	G1	G2	G3	IC				P
9QM	KD3	PD3	IC	H	H	PD2	KD2	PD1	KD1				
9QP	KT	GT	PT	H	H,IS G3P	KP	G1P	G2P	PP				
9QT	KT	G1B	KB G3B	H	H	PB	G2B	PT	GT				
9QU	G2	G1	K	H	H	G3	G2	IC	P				
9QY	Pf	GT	KT,IS G3P	H	H	G1P	KP	G2P	PP				
9QZ	PP2	G3P2	K	H	H	PP1	G3P1	G2	G1				
9RA	P	IC	G2	H	H	G3,PD	G1	G1	K				
9RF	K	G1	NC	H	H	G3	P	NC	G2				

Terminal Diagram	PIN NUMBER												
	1	2	3	4	5	6	7	8	9	10	11	12	TC
9RG	F,IS	IC	IC	IC	F	IC	NC	IC	IC				P
9RJ	G1	G3	G2	H	H	G2	G3	G1	K				P
9RL	KP,IS G3P	G2P	PP	H	H	PD2	KD	PD1	G1P				
9RQ	PT3	PT2	PT1	H	H	GT1	K	GT2	GT3				
9RT	H,K IS	H	IC	H,K IS	H	H,K IS	IC	H	H,K IS				P
9RU	DJ2	DJ1	G3	HB	HA,IS	G1	K,G2	P2	P1				
9RX	IC	P	IC	H	H	P	IC	IC	K				
9SB	G1	K,G3	K,G3	H	H	G2	G1	IC	P				
9SG	HI	P	IC	H	H	IC	P	IC	NC				K
9U	P	IC	IC	F	F	IC	IC	IC	P				
9V	P	NC	H	G	G	K	G	G	H				
9X	G1	NC	H	K,IS G3	NC	P	NC	G2	H				
9Y	F,IS	F	LC	F,IS	F	F,IS	LC	F	F,IS				P
10F	G1TR2	G2TR2	PTR2	H	H	KTR1	G1TR1	PTR1	KTR2	KD1 IS			
10G	PT3	GP3	KT3	H	H	PT2	GT1	PT1	GT2	KT1 KT2			
10H	G1P	G2P	PP	H	H	GP3 IS	KT	GT	PT	KP			
10K	KT	KP	G1P	G3P IS	H	H	PP	G2P	PT	GT			
10L	G1P2	KP2 G3P2	G2P2	PP2	H	H	KP1 G3P1 IS	G1P1	G2P1	PP1			
12AQ		P		G				K		H		H	
12AS		G2		G1				K		H		H	P
12BF	H	KT2	GT2	PT2	GT1	PT1	KT1	PD2	KD1 KD2	PD1	IS	H	
12BJ	H	G2	G1	K,G3	IC	IC	P	IC	IC	K	G1	H	
12BL	H	NC	NC	P	NC	NC	K	NC	NC	P	NC	H	

Terminal Diagram	PIN NUMBER												TC
	1	2	3	4	5	6	7	8	9	10	11	12	
12BM H	NC	GT2	NC	PT2	IC	KT2	NC	KT1	GT1	PT1	H		
12BQ H	PT3	KT3	KT1	PT2	KT2	GT2	IC	GT1	PT1	GT3	H		
12BT H	G2P	K,G3P	PB	G3B	G2B	G1B	KB,IS	PP	NC	G1P	H		
12BU H	KP	G1P	G3P	IS	PP	G2P	G1B	KB G3B	G2B	PB	H		
12BW H	G2P2	PP2	G3P2 IS	G1P2	KP2	G2P1	KP1	PP1	G3P1 IS	G1P1	H		
12BY H	PT3	KT3	KT1	PT2	KT2	GT2	IS	GT1	PT1	KT3	H		
12CA H	G1P	G2P	KT2	GT2	PT2	PT1	GT1	KT1	KP,IS G3P	PP	H		
12CT	K		K				K		H	SHEL G	H	P	
12DA H	KD2	PD2	KT2	GT2	PT2	PT1	GT1	KT1	PD1	KD1	H		
12DG H,K IS	IC	IC	LC	LC	IC	IC	IC	IC	LC	IC	H	P	
12DM H	PP2	G2P2	G3P2	G1P2	KP2	G3P1 IS	PP1	G2P1	G1P1	KP1	H		
12DP H	PP	GT2	PT2	KT1	GT1	KT2 IS	PT1	KP,IS G3P	G2P	G1P	H		
12DQ F,IS	IC	IC	LC	IC	IC	IC	IC	IC	LC	IC	F	P	
12DR H	NC	G2	K,G3	G1	NC	G2	NC	G1	K,G3	G2	H	P	
12DZ H	PT	NC	PB	NC	G1B	G1B	G2B	KB G3B	GT	KT	H		
12EA P	P		G		G	K			H		H		
12EJ H	NC	GT2	NC	PT2	IC	KT2	GT2	KT1	GT1	PT1	H		
12EO H	NC	GT2	NC	PT2	NC	KT2	IC	KT1	GT1	PT1	H		
12ER H	PP2	G2P IS	G1P	G3P2	PP1	G3P1	K IS	GT	KT	PT	H		
12ES H	NC	G1	K,G3	G2	IC	P	IC	G2	K,G3	G1	H		
12EW H,K IS	H,K IS	IC	LC	IC	H,K IS	LC	IC	H,K IS	LC	IC	H	P	
12EY H	G1	G2	K,G3	NC	P	NC	NC	G1	G2	K,G3	H		
12EZ H	KP IS	G1P	NC	G3P	G2P	PP	G1B	G3B KB	G2B	PB	H		

Terminal Diagram	PIN NUMBER												TC
	1	2	3	4	5	6	7	8	9	10	11	12	
12FA	H	IC	IC	IC	K,IS	G	NC	IC	IC	IC	IC	H	P
12FB	H	NC	G2	K,G3	G1	G2	NC	G2	G1	K,G3	G2	H	P
12FC	H	PD	NC	KD	PP	NC	IC	KP G3P	G1P	G2P	G1P	H	
12FE	H	PT3	KT3	KT1	PT2	KT2	GT2	NC	GT1	PT1	GT3	H	
12FJ	H	K	G2	G3	G1	NC	NC	IC	NC	G3	NC	H	P
12FK	H	K	G2	G3	NC	NC	P	NC	NC	G3	G1	H	
12FL	H	K	G1	G3	G2	IC	P	IC	G2	G3	G1	H	
12FM	H	PT	NC	GT	KT	IS	NC	G1P	KP G3P	G2P	PP	H	
12FN	H	PD	NC	KD	PB	NC	IC	KB G3B	G1B	G1B	G2B	H	
12FP	H	KT2	PT2	GT2	KT1 IS	GT1	PT1	G1P	G2P	PP	KP,IS G3P	H	
12FQ	H	PT2	KT2	KT1	IC	NC	NC	IS	GT1	PT1	GT2	H	
12FR	H	PT2	KT2	KT1	NC	NC	PT1	NC	GT1	PT1	GT2	H	
12FS	H	PD	NC	KD	PP	NC	IC	KP G3P	G1P	IC	G2P	H	
12FU	H	PP2	G2P2	G3P2	KP2	G1P2	PP1	G3P1 IS	G2P1	KP1	G1P1	H	
12FV	H,K IS	H,K IS	IC	NC	H,K IS	H,K IS	NC	H	K	NC	IC	H	P
12FX	H	NC	NC	P	IC	IC	K	IC	IC	P	NC	H	
12FY	H	K	G2	G3	G1	NC	IC	NC	IC	G3	G2	H	P
12GA	H	NC	NC	P	IC	NC	K	NC	IC	P	NC	H	
12GC	H	PP	GT2	KT2	GT1	KT1	PT1	KP,IS G3P	PT2	G2P	G1P	H	
12GD	H	K	G2	G3	G1	NC	NC	NC	IC	G3	IC	H	P
12GF	H	KP2	G1P2	G2P2	PP2	G3P2 IS	G1P1	KP1	G2P1	G3P1 IS	PP1	H	
12GH	H	NC	G2	G3	G1	NC	IC	NC	IC	K	IC	H	P
12GJ	H	K	G2	G3	G1	NC	IC	NC	IC	G3	IC	H	P
12GK	H	IC	IC	P	IC	IC	K	IC	IC	P	IC	H	

Terminal Diagram	PIN NUMBER												TC
	1	2	3	4	5	6	7	8	9	10	11	12	
12GL H	G1P	G2P	KP,IS G3P	KT2 IS	PT2	KT1	GT2	PT1	GT1	PP	H		
12GS H	PP	GT2	KT2	GT1	KT1 G3P IS	PT1	KP	PT2	G2P	G1P	H		
12GU H	NC	G2	G3	G1	NC	IC	NC	IC	K	IC	H	P	
12GV H	IC	IC	NC	IC	H	IC	IC	IC	NC	IC	H	P	
12GW H	K	G2	G3	G1	NC	IC	NC	G1	G3	G2	H	P	
12GY H	G	BP	K	IC	IC	P	IC	IC	BP	G	H		
12GZ H	PT2	GT2	NC	PP	IC	K,G3P	G1P	G2P	GT1	PT1	H		
12HA H,K IS	H,K IS	IC	NC	H,K IS	H,K IS	NC	IC	H,K IS	NC	IC	H	P	
12HB H	G3P2	PP2	G2P2	KP2	G1P2	G1P1	KP1	G2P1	PP1	G3P1	H		
12HC H	IC	IC	IC	K	G	IC	IC	IS	IC	IC	H	P	
12HD H	KP2	G1P2	G2P2	PP2	G3P2 IS	G3P1 IS	PP1	G2P1	KP1	G1P1	H		
12HE H	PP	NC	G3P	GT	KT	PT	IS	KP	G2P	G1P	H		
12HF H	IC	NC	P	IC	IC	K	IC	IC	P	NC	H		
12HG H	PT3	K	PT2	NC	PT1	NC	GT1	NC	GT2	GT3	H		
12HJ H	GT	PT	KT	G1P	G1P	KP	G2P	G3P IS	NC	PP	H		
12HK F,IS	F,IS	IC	NC	F,IS	F,IS	NC	F	F,IS	NC	IC	F	P	
12HL H	IC	IC	K,G3	G1	NC	IC	NC	IC	K,G3	G2	H	P	
12HN H	PT2	GT2	PT1	KT1	GT1	KT2 G3P	G1P	KP	G2P	PP	H		
12HR H	PT2	GT2	PP	G2P	IC	KT2 KP G3P	G1P	PT1	KT1	GT1	H		
12HT H	PD	NC	KD	PP	NC	IC	KP G3P	G1P	NC	G2P	H		
12HU H	PT3	K	PT2	NC	PT1	IC	GT1	IC	GT2	GT3	H		
12HWH	PT2	PP	G2P	G1P	G1P KP	KT2	KT1	GT1	PT1	GT2	H		
12HX H	IC	NC	P	IC	IC	IC	IC	IC	P	NC	H	K	

Terminal Diagram	PIN NUMBER												
	1	2	3	4	5	6	7	8	9	10	11	12	TC
12HY	H, K IS	H, K IS	IC	NC	H, K IS	IC	IC	H	H, K IS	NC	IC	H	P
12JA	H	K	G2	G3	G1	NC	H	NC	G2	G3	G2	H	P
12JB	H, K IS	H, K IS	IC	NC	H, K IS	IC	H, K IS	H	H, K IS	NC	NC	H	P
12JF	H	K	G2	G3	G1	NC	NC	NC	IC	G3	G2	H	P
17— BR25	G1	G1	G3	H	H	G2	G2	G3	K				P
407A	HT2	KT2	GT2	PT2	HM, IS	PT1	GT1	KT1	HT1				
991*	K	P											
991*	P F	K F	OR										P
5672	P	G2	F+	G1	F-, G3								
5678	P	G2	F-, IS G3	G1	F+ G3								
5734				H	G	H	K, IS	SHELL	P				
5783*	K		P		K								
6360	G1TR1	K IS	G1TR2	HTR1	HTR2	PTR1	G2TR1 G2TR2	PTR2	HM				
6977	F	P	G	F									
8888	K	K		K		K	SHELL	G		H		H	P
8950	H	K	G2	G3	G1	K	IC	NC	G1	G3	G2	H	P

METAL TYPES

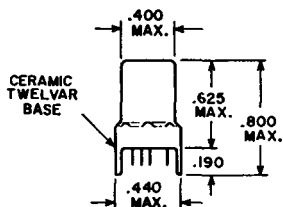

-1-

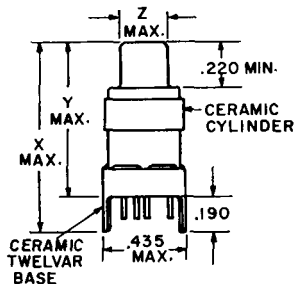

-1A-

	X	Y	Z
1A1	1.050	0.840	.255
1A2	0.985	0.780	.255
1A3	0.985	0.780	.317

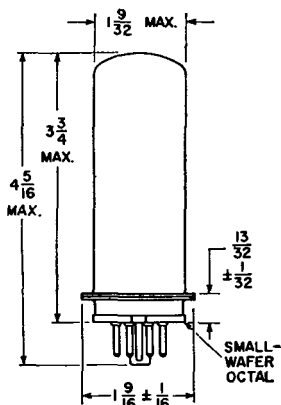

-4-

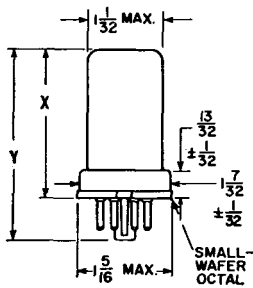

-2-

	Y	X
2A	2-5/8	2-1/16
2B	3-1/4	2-11/16

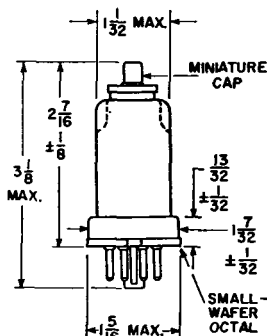

-3-

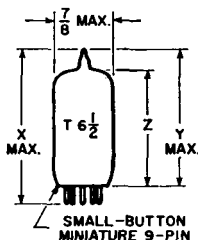

-6-

	X	Y
6A	1-3/4	1-1/2
6B	2-3/16	1-15/16
6C	2-13/32	2-5/32
6D	2-7/16	2-13/16
6E	2-5/8	2-3/8
6F	2-3/4	2-1/2
6G	3-1/16	2-13/16
6H	3-1/8	2-7/8
6J	2	1-3/4
6K	2-7/16	2-3/16
6L	2-7/8	2-5/8
6M	1-31/32	1-23/32
6N	2-27/32	2-19/32
	Z	
6A	1-1/8 ± 3/32	
6B	1-9/16 ± 3/32	
6C	1-25/32 ± 3/32	
6D	1-13/16 ± 3/32	
6E	2 ± 3/32	
6F	2-1/8 ± 3/32	
6G	2-7/16 ± 3/32	
6H	2-1/2 ± 3/32	
6K	1-29/32	

GLASS TYPES

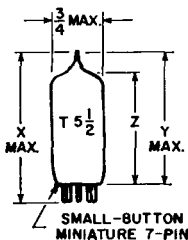

-5-

	X	Y	Z
5A	1-5/8	1-3/8	1 ± 3/32
5B	1-3/4	1-1/2	1-1/8 ± 3/32
5C	2-1/8	1-7/8	1-1/2 ± 3/32
5D	2-5/8	2-3/8	2 ± 3/32
5E	2-3/8	2-1/8	1-3/4 ± 3/32

All measurements in inches.

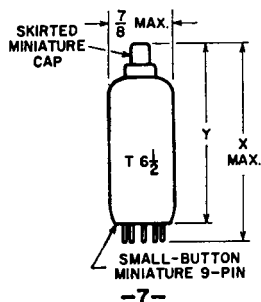

	X	Y
7A	2-27/32	2-7/16 ± 1/8
7B	3-1/16	2-15/32 MAX.
7C	3-9/32	2-7/8 ± 1/8
7D	3-1/2	3-1/4 MAX.
7E	2-17/32	2-1/8 ± 1/8
7F	2-29/32	2-5/8 MAX.
7G	2-23/32	2-1/8 ± 1/8
7H	3-3/16	2-15/16

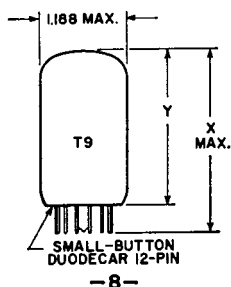

	X	Y
8A	1.875	1.250-1.500
8B	2.375	1.750-2.000
8C	2.625	2.000-2.250
8D	2.875	2.250-2.500
8E	3.050	2.770 MAX.
8F	3.125	2.500-2.750
8G	3.375	2.750-3.000

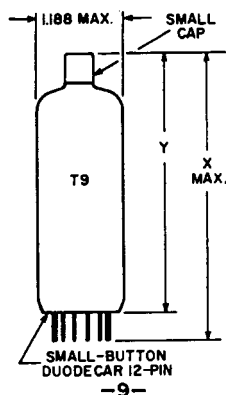

	X	Y
9A	3.375	2.750-3.000
9B	3.625	3.000-3.250
9C	4.110	3.766 MAX.
9D	3.875	3.250-3.500

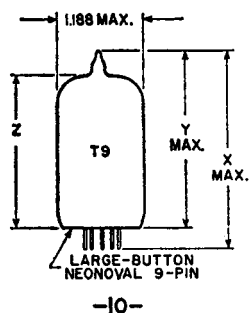

	X	Y	Z
10A	2.630	2.320	1.770-2.010
10B	2.900	2.620	2.070-2.310
10C	2.930	2.620	2.070-2.310
10D	3.230	2.920	2.370-2.610
10E	4.125	3.750	
10F	3.110	2.730	
10G	3.080	2.770	
10F	3.511	3.169	2.68

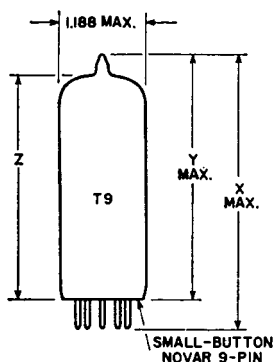

	X	Y	Z
11A	3.000	2.620	2.100-2.280
11B	3.080	2.700	2.050-2.230
11C	3.110	2.730	2.210-2.390
11D	3.410	3.010	2.510-2.690
11E	2.960	2.580	2.060-2.240

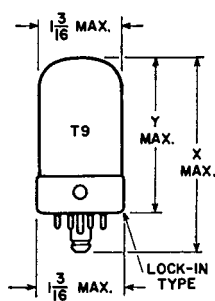

	X	Y
12A	2-9/32	1-3/4
12B	2-25/32	2-1/4
12C	3-5/32	2-5/8

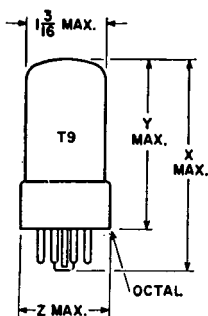

-13-

	X	Y	Z
13A	2-7/8	2-5/16	1-9/32
13B	3	2-7/16	1-9/32
13C	3-1/16	2-1/2	1-9/32
13D	3-5/16	2-3/4	1-5/16
13E	3-3/8	2-13/16	1-9/32
13F	3-7/16	2-7/8	1-9/32
13G	3-13/16	3-1/4	1-9/32
13H	4-3/16	3-9/16	1-3/16

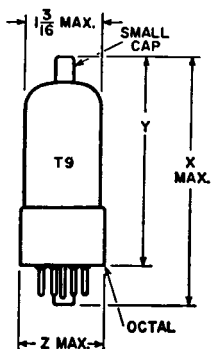

-14-

	X	Y	Z
14A	3-5/16	2-3/4	1-5/16
14B	3-9/16	3	1-9/32
14C	3-5/8	3-1/16	1-9/32
14D	3-7/8	3-5/16	1-9/32
14E	4-1/16	3-1/2	1-9/32
14F	3-13/16	3-1/4	1-9/32
14G	3-13/16	3-1/4	1-3/8
14H	3-13/16	3-1/4	1-1/4
14J	3-9/16	3	1-1/4
14K	4-5/16	3-3/4	—
14L	4-21/64	3-3/4	1-9/32

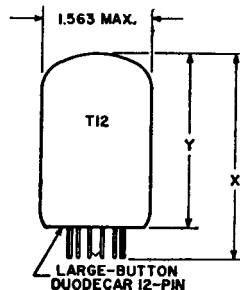

-15-

	X	Y
15A	2.875	2.250-2.500
15B	3.375	3.000 MAX.
15C	3.625	3.000-3.250
15D	3.125	2.750
15E	3.875	3.250-3.500
15F	4.250	3.625-3.875

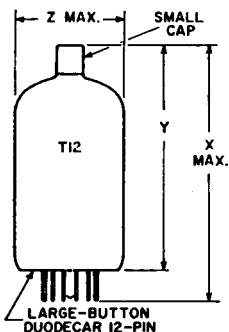

-16-

	X	Y	Z
16A	3.625	3.000-3.250	1.563
16B	4.125	3.500-3.750	1.563
16C	4.875	4.250-4.500	1.563
16D	4.375	4.000 MIN.	1.563
16E	4.375	3.750-4.000	1.563
16F	4.95	4.57 MAX.	1.563
16G	4.625	4.000-4.250	1.563
16H	4.75	4.125-4.375	1.563

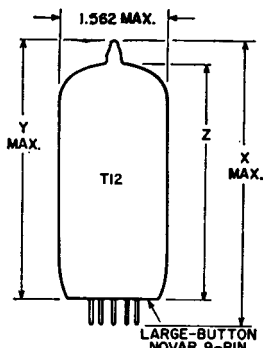

-17-

	X	Y	Z
17A	3.180	2.800	2.280-2.460
17B	3.410	3.030	2.510-2.690
17C	4.160	3.780	3.260-3.440
17D	3.550	3.170	—
17E	3.710	3.330	2.810-2.900

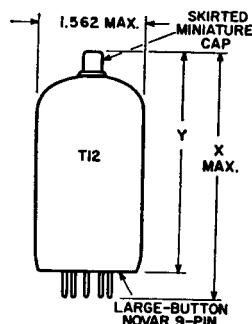

-18-

	X	Y
18A	3.55	3.04 ± 0.13
18B	4.60	4.09 ± 0.13
18C	4.38	3.75-4.00
18D	4.625	4.25
18E	3.63	3.0-3.25
18F	3.85	3.21-3.47

All measurements in inches.

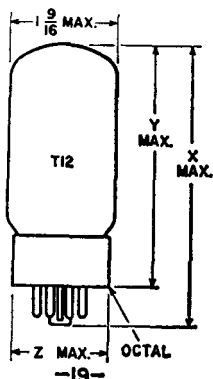

	X	Y	Z
19A	3-9/16	3	1-9/32
19B	3-7/8	3.5/16	1-13/32
19C	4	3-7/16	1-13/32
19D	4-1/4	3-11/16	1-3/8
19E	4-5/8	4-1/16	1-3/8
19F	4-5/8	4-1/16	1-5/8
19G	4-3/4	4-3/16	1-11/16
19H	5-3/16	4-5/8	1-3/8
19J	4-1/2	3-7/8	—

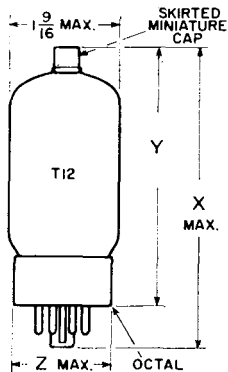

	X	Y	Z
20A	4-1/4	3-11/16	1-13/32
20B	5	4-7/16	1-3/8

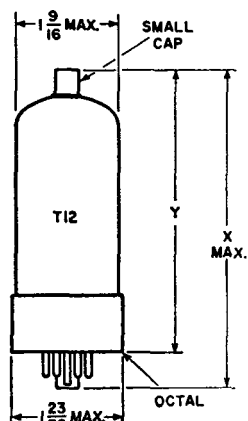

	X	Y
21A	4-3/4	4 ± 3/16
21B	5	4-7/16
21C	5-7/32	4-1/4
21D	5	4-1/4

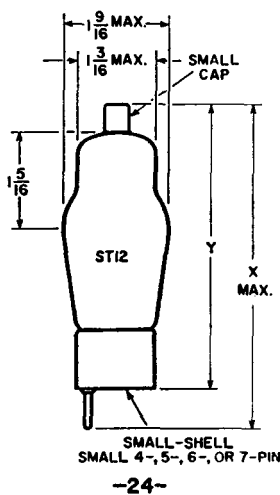
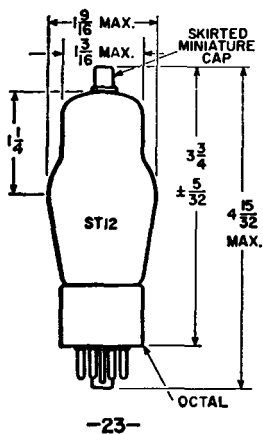
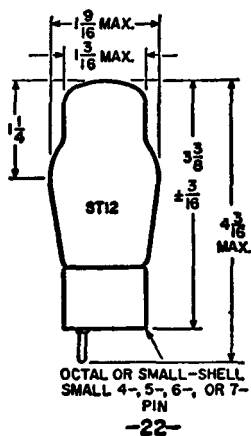

	X	Y
24A	4-15/16	4-3/16 ± 1/8
24B	4-17/32	3.25/32 ± 1/8

All measurements in inches.

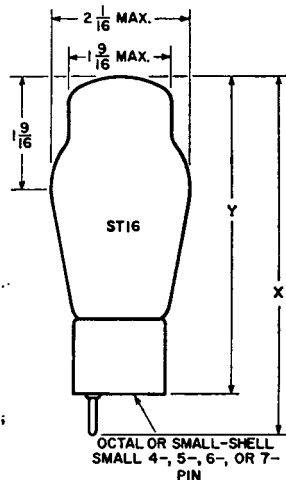
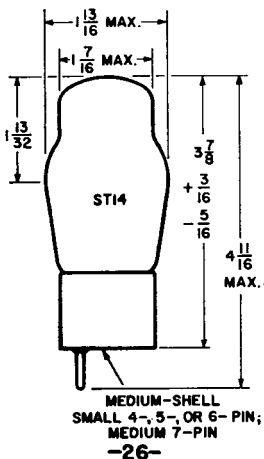
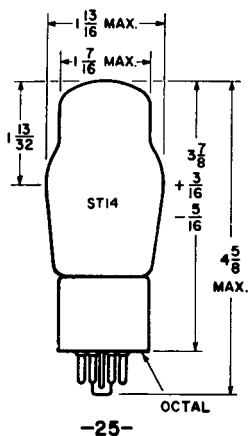

	X	Y
27A	5-1/8	4-3/8 ± 3/16
27B	5-3/8	4-9/16 ± 3/16

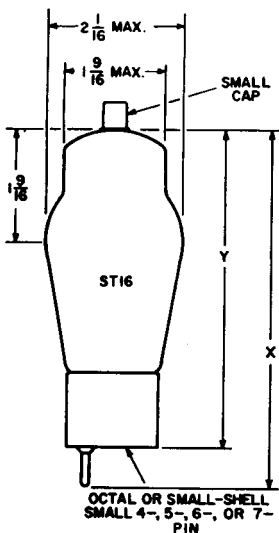

	X	Y
28A	5-1/8	4-7/16 ± 5/32
28B	5-11/16	4-31/32 ± 5/32

	MAX. LENGTH	MAX. DIAMETER
29A	1-3/4	0.4
29B	1-3/4	1-5/16
29C	2-5/16	1-5/16
29D	2-5/8	1-1/16
29E	2-7/8	1-5/16
29F	3	1-5/16
29G	3-7/16	1-15/16
29H	4	1-3/16
29J	4-7/8	1-9/16
29K	5-1/32	1-13/16
29L	6-1/4	2-7/16
29M	3-15/32	1-7/16
29N	5.31	1.813
29P	3.937	1.530
29Q	4.062	1.530

-29-

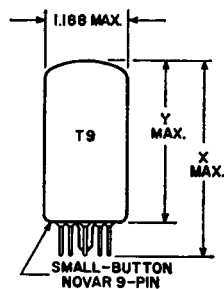

	X	Y
30A	2.380	2.000
30B	3.005	2.625
30C	3.080	2.700
30D	3.110	2.730
30E	2.125	1.750
30F	3.380	3.000

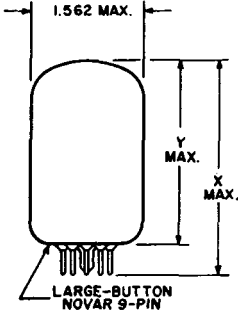

-31-

	X	Y
31A	2.880	2.500
31B	3.130	2.750
31C	3.880	3.500
31D	3.380	3.000

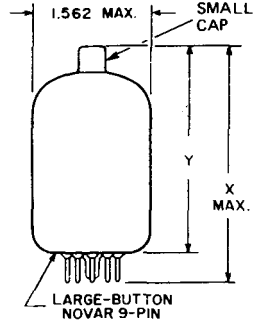

-32-

	X	Y
32A	3.505	2.875-3.125
32B	4.130	3.500-3.750
32C	4.380	3.750-4.000
32D	4.60	4.09-4.22

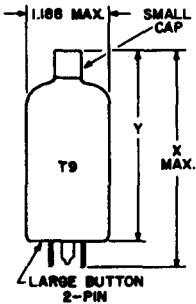

-33-

	X	Y
33A	3.06 MAX.	2.52-2.68

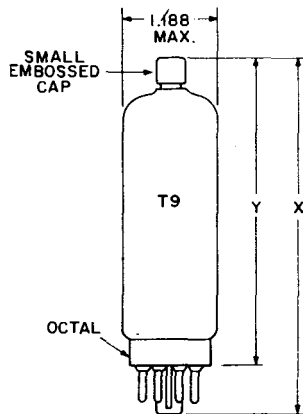

-34-

	X	Y
34A	4.312 MAX.	3.75 MAX.

All measurements in inches.

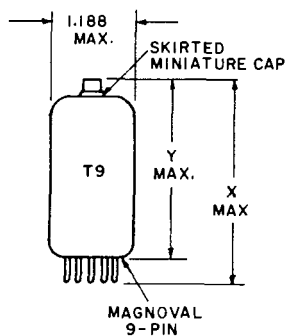

-35-

	X	Y
35A	4.133	3.760
35B	4.125	3.750
35C	4.54	4.18

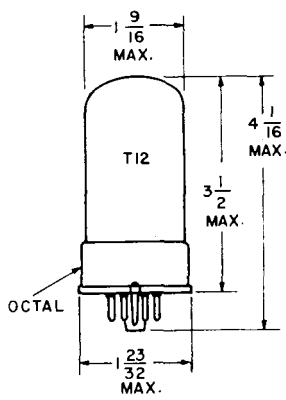

-36-

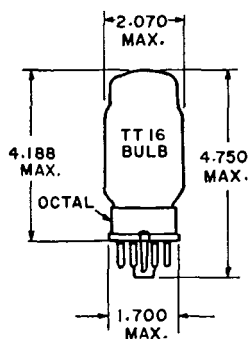

-37-

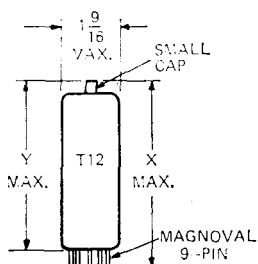

-38-

	X	Y
38A	4-29/32	4-9/16

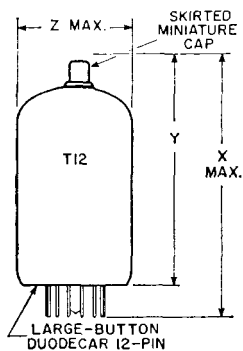

-39-

	X	Y	Z
39A	3.625	3.0-3.250	1.563
39B	4.375	4.0 MAX.	1.563

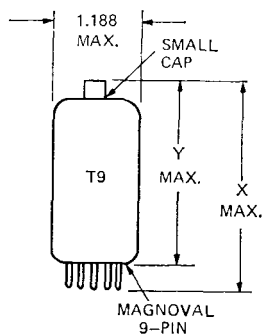

-40-

	X	Y
40A	4.133	3.760
40B	3.850	3.470
40B	(Novar Base)	

All measurements in inches.

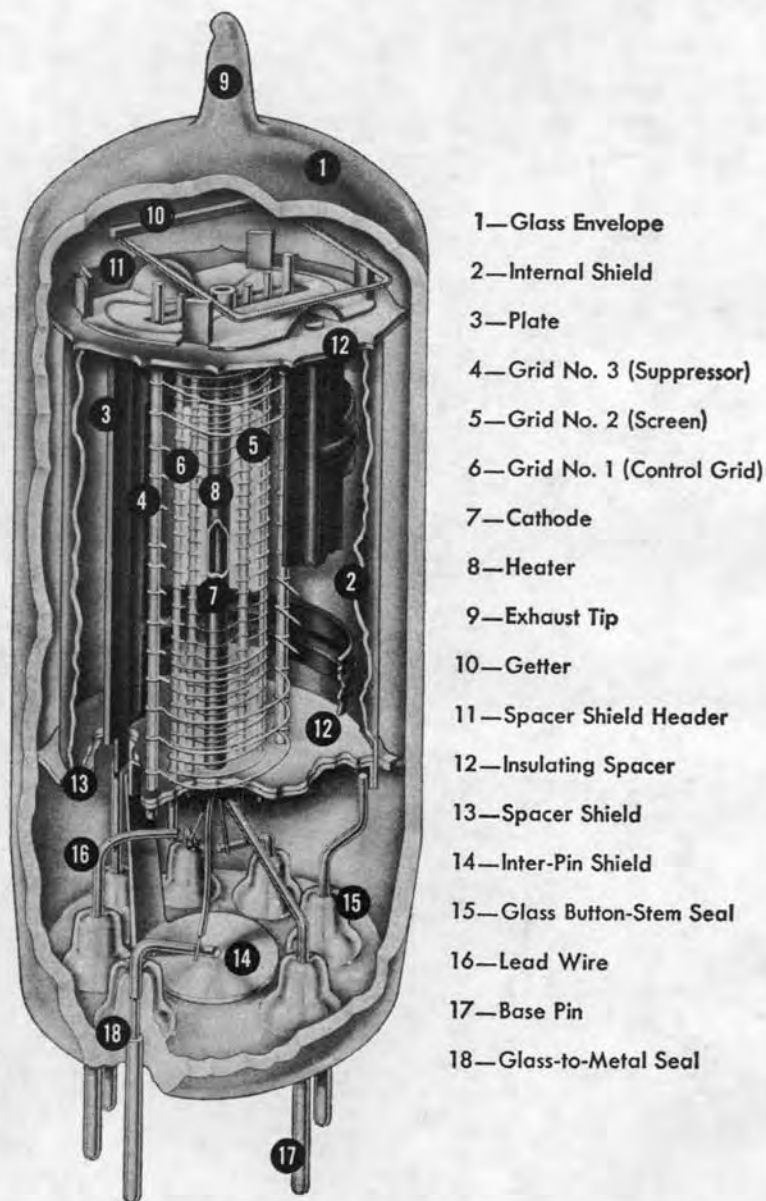

- 1—Glass Envelope
- 2—Internal Shield
- 3—Plate
- 4—Grid No. 3 (Suppressor)
- 5—Grid No. 2 (Screen)
- 6—Grid No. 1 (Control Grid)
- 7—Cathode
- 8—Heater
- 9—Exhaust Tip
- 10—Getter
- 11—Spacer Shield Header
- 12—Insulating Spacer
- 13—Spacer Shield
- 14—Inter-Pin Shield
- 15—Glass Button-Stem Seal
- 16—Lead Wire
- 17—Base Pin
- 18—Glass-to-Metal Seal

Structure of a Miniature Tube

Resistance-Coupled Amplifiers

RESISTANCE-COUPLED, audio-frequency voltage amplifiers utilize simple components and are capable of providing essentially uniform amplification over a relatively wide frequency range.

Suitable Tubes

In this section, data are given for 48 types of tubes suitable for use in resistance-coupled circuits. These types include low- and high- μ triodes, twin triodes, triode-connected pentodes, and pentodes. The accompanying key to tube types will assist in locating the appropriate data chart.

Circuit Advantages

For most of the types shown, the data pertain to operation with cathode bias; for all of the pentodes, the data pertain to operation with series screen-grid resistor. The use of a cathode-bias resistor where feasible and a series screen-grid resistor where applicable offers several advantages over fixed-voltage operation.

The advantages are: (1) effects of possible tube differences are minimized; (2) operation over a wide range of plate-supply voltages without appreciable change in gain is feasible; (3) the low frequency at which the amplifier cuts off is easily changed; and (4) tendency toward motorboating is minimized.

Number of Stages

These advantages can be enhanced by the addition of suitable decoupling filters in the plate supply of each stage of a multi-stage amplifier. With proper filters, three or more amplifier stages can be operated from a single power-supply unit of conventional design with-

Type	Chart No.	Type	Chart No.
3AU6	2	6FQ7/	
3AV6	9	6CG7	8
3BC5/		6SL7GT	5
3CE5	11	6SN7GTB	8
3CB6/		6T8A	5
3CF6	11	7AU7	3
4AU6	2	8CN7	5
4AV6	9	8FQ7/	
4BQ7A/		8CG7	8
4BZ7	10	9AU7	3
4CB6	11	12AT6	5
5BK7A	10	12AT7/	
		ECC81	4
5BQ7A	10	12AU6	2
5T8	5	12AU7A/	
6AB4	4	ECC82	3
6AG5	11	12AV6	9
6AT6	5	12AX7A/	
6AU6A	2	ECC83	9
6AV6	9	12AY7	1
6BC5/		12FQ7	8
6CE5	11	12SL7GT	5
6BK7B	10	12SN7GTA	8
6BQ7A/		19T8	5
6BZ7/		20EZ7	9
6BS8	10		
6C4	3	5879P	6
6CB6A/		5879T	7
6CF6	11	7025	9
6CN7	5	7199P	12
6EU7	9	7199T	13

T = Triode Unit or Triode Connection
P = Pentode Unit or Pentode Connection

KEY TO CHARTS

out encountering any difficulties due to coupling through the power unit. When decoupling filters are not used, not more than two stages should be operated from a single power-supply unit.

Symbols Used in Resistance-Coupled Amplifier Charts

- C = Blocking Capacitor (μF).
 C_k = Cathode Bypass Capacitor (μF).
 C_{gs} = Screen-Grid Bypass Capacitor (μf).
 E_{bb} = Plate-Supply Voltage (volts).
 Voltage at plate equals plate-supply voltage minus drop in R_p and R_k .
 R_k = Cathode Resistor (ohms).
 R_{gs} = Screen-Grid Resistor (megohms).
 R_g = Grid Resistor (megohms) for following stage.
 R_p = Plate Resistor (megohms).
 V.G. = Voltage Gain.
 E_o = Output Voltage (peak volts).
 This voltage is obtained across R_k (for following stage) at any frequency within the flat region of the output vs. frequency curve, and is for the condition where the signal level is adequate to swing the grid of the resistance-coupled amplifier tube to the point where its grid starts to draw current.

Note: The listed values for E_o are the peak output voltages available when the grid is driven from a low-impedance source. The listed values for the cathode resistors are optimum for any signal source. With a high-impedance source, protection against severe distortion and loss of gain due to input loading may be obtained by the use of a coupling capacitor connected directly to the input grid and a high-value resistor connected between the grid and ground.

General Circuit Considerations

In the discussions which follow, the frequency (f_2) is that value at which the high-frequency response begins to fall off. The frequency (f_1) is that value at which the low-frequency response drops below a satisfactory value, as discussed below. A variation of 10 per cent in values of resistors and capacitors has only slight effect on perform-

ance. One-half-watt resistors are usually suitable for R_{gs} , R_g , R_p , and R_k resistors. Capacitors C and C_{gs} should have a working voltage equal to or greater than E_{bb} . Capacitor C_k may have a low working voltage in the order of 10 to 25 volts.

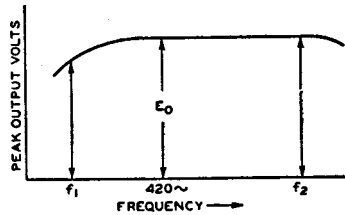

Triode Amplifier Heater-Cathode Type

Capacitors C and C_k have been chosen to give an output voltage equal to $0.8 E_o$ for a frequency (f_1) of 100 Hz. For any other value of f_1 , multiply values of C and C_k by $100/f_1$. In

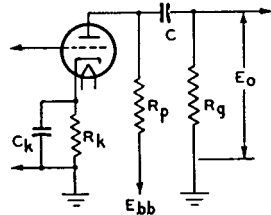

Diagram No. 1

the case of capacitor C_k , the values shown in the charts are for an amplifier with dc heater excitation; when ac is used, depending on the character of the associated circuit, the gain, and the value of f_1 , it may be necessary to increase the value of C_k to minimize hum disturbances. It may be desirable to operate the heater at a positive voltage of from 15 to 40 volts with respect to the cathode. The voltage output at f_1 of "n" like stages equals $(0.8)^n \times E_o$, where E_o is the peak output voltage of final stage. For an amplifier of typical construction, the value of f_2 is well above the audio-frequency range for any value of R_p .

Pentode Amplifier

Heater-Cathode Type

Capacitors C , C_k , and C_{g2} have been chosen to give an output voltage equal to $0.7 \times E_o$ for a frequency (f_1) of 100 cycles. For any other value of f_1 , multiply values of C , C_k , and C_{g2} by $100/f_1$. In the case of capacitor C_k , the values shown in the charts are for

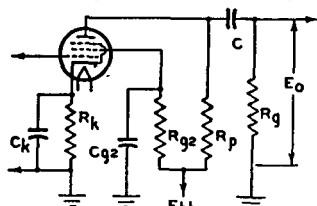

Diagram No. 2

an amplifier with dc heater excitation; when ac is used, depending on the character of the associated circuits, the voltage gain, and the value of f_1 , it may be necessary to increase the value of C_k to minimize hum disturbances. It may be desirable to operate the heater at a positive voltage of from 15 to 40 volts with respect to the cathode. The voltage output at f_1 for "n" like stages equals $(0.7)^n \times E_o$ where E_o is peak output voltage of final stage. For an amplifier of typical construction, and for R_p values of 0.1, 0.25, and 0.5 megohm, approximate values of f_2 are 20000, 10000, and 5000 Hz, respectively.

E_{bb}	R_p	R_g	R_{g2}	R_k	C_{g2}	C_k	C	E_o^*	V.G.
90	0.1	0.24	—	1800	—	—	—	13	24
	0.24	0.51	—	3700	—	—	—	14	26
	0.51	1.0	—	7800	—	—	—	16	27
180	0.1	0.24	—	1300	—	—	—	31	27
	0.24	0.51	—	2800	—	—	—	33	29
	0.51	1.0	—	5700	—	—	—	33	30
300	0.1	0.24	—	1200	—	—	—	58	28
	0.24	0.51	—	2300	—	—	—	30	30
	0.51	1.0	—	4800	—	—	—	56	31

1

12AY7*

Diagram 1

* One triode unit.

* Peak volts.

^ Coupling capacitors should be selected to give desired frequency response. Cathode resistors should be adequately bypassed.

2

3AU6
4AU6
6AU6A
12AU6

See Circuit
Diagram 2

	E_{bb}	R_p	R_g	R_{g2}	R_k	C_{g2}	C_k	C	E_c^*	V.G.
90	0.22	0.22	0.340	2700	0.057	5.8	0.0081	16	79	
	0.22	0.47	0.370	2900	0.050	5.4	0.0055	22	104	
	0.22	1.0	0.380	3100	0.050	5.3	0.0034	25	125	
	0.47	0.47	1.00	6000	0.027	2.8	0.0042	13	105	
	0.47	1.0	1.00	6200	0.023	2.7	0.0027	17	137	
	0.47	2.2	1.00	6300	0.027	2.8	0.0019	25	161	
	1.0	1.0	1.90	10800	0.017	1.7	0.0025	10	139	
	1.0	2.2	2.40	13100	0.017	1.7	0.0017	19	184	
180	0.22	0.22	0.520	1340	0.059	8.8	0.0081	31	143	
	0.22	0.47	0.520	1390	0.059	8.7	0.0053	43	192	
	0.22	1.0	0.520	1420	0.059	8.6	0.0032	48	223	
	0.47	0.47	1.05	2700	0.039	5.5	0.0041	34	189	
	0.47	1.0	1.15	2880	0.037	5.4	0.0027	43	249	
	0.47	2.2	1.20	2960	0.036	5.4	0.0019	50	294	
	1.0	1.0	2.40	5500	0.028	3.2	0.0023	33	230	
	1.0	2.2	2.70	6000	0.022	2.8	0.0015	40	323	
300	0.22	0.22	0.530	780	0.077	13.2	0.0082	53	200	
	0.22	0.47	0.540	783	0.077	13.2	0.0053	65	270	
	0.22	1.0	0.540	800	0.077	13.1	0.0033	74	316	
	0.47	0.47	1.15	1590	0.057	8.4	0.0045	56	275	
	0.47	1.0	1.22	1650	0.049	7.4	0.0027	72	357	
	0.47	2.2	1.31	1720	0.045	7.2	0.0017	82	418	
	1.0	1.0	2.50	3300	0.036	5.3	0.0022	57	352	
	1.0	2.2	2.80	3500	0.031	4.2	0.0015	72	466	

3

6C4
7AU7*
9AU7*
12AU7A/
ECC82*

See Circuit
Diagram 1

90	0.047	0.047	—	1600	—	3.2	0.061	9	10
	0.047	0.1	—	1800	—	2.5	0.033	11	11
	0.047	0.22	—	2000	—	2.0	0.015	14	11
	0.1	0.1	—	3000	—	1.6	0.032	10	11
	0.1	0.22	—	3800	—	1.1	0.015	15	11
	0.1	0.47	—	4500	—	1.0	0.007	18	11
	0.22	0.22	—	6800	—	0.7	0.015	14	11
	0.22	0.47	—	9500	—	0.5	0.0065	20	11
	0.22	1.0	—	11500	—	0.43	0.0035	24	11
	180	0.047	0.047	—	920	—	3.9	0.062	20
0.047		0.1	—	1200	—	2.9	0.037	26	12
0.047		0.22	—	1400	—	2.5	0.016	29	12
0.1		0.1	—	2000	—	1.9	0.032	24	12
0.1		0.22	—	2800	—	1.4	0.016	33	12
0.1		0.47	—	3600	—	1.1	0.007	40	12
0.22		0.22	—	5300	—	0.8	0.015	31	12
0.22		0.47	—	8300	—	0.56	0.007	44	12
0.22		1.0	—	10000	—	0.48	0.0035	54	12
300		0.047	0.047	—	870	—	4.1	0.065	38
	0.047	0.1	—	1200	—	3.0	0.034	52	12
	0.047	0.22	—	1500	—	2.4	0.016	68	12
	0.1	0.1	—	1900	—	1.9	0.032	44	12
	0.1	0.22	—	3000	—	1.3	0.016	68	12
	0.1	0.47	—	4000	—	1.1	0.007	80	12
	0.22	0.22	—	5300	—	0.9	0.015	57	12
	0.22	0.47	—	8800	—	0.52	0.007	82	12
	0.22	1.0	—	11000	—	0.46	0.0035	92	12

* One triode unit.

* Peak volts.

E_{bb}	R_p	R_g	R_{g^2}	R_k	C_{g^2}	C_k	C	E_o^*	V.G.
90	0.1	0.1	—	2680	—	2.4	0.026	8	24
	0.1	0.22	—	3060	—	2.00	0.014	11	25
	0.1	0.47	—	3390	—	1.84	0.0074	13	28
	0.22	0.22	—	5500	—	1.33	0.0136	10	25
	0.22	0.47	—	6300	—	1.01	0.0067	14	28
	0.22	1.0	—	6930	—	0.92	0.0038	15	28
	0.47	0.47	—	10900	—	0.63	0.007	13	26
	0.47	1.0	—	12500	—	0.52	0.0043	14	28
	0.47	2.2	—	13500	—	0.47	0.0031	18	28
180	0.1	0.1	—	1407	—	3.6	0.029	20	31
	0.1	0.22	—	1674	—	3.0	0.016	28	33
	0.1	0.47	—	1786	—	2.6	0.0083	31	34
	0.22	0.22	—	2890	—	1.75	0.0140	24	33
	0.22	0.47	—	3860	—	1.34	0.0077	35	33
	0.22	1.0	—	4660	—	1.14	0.0047	42	33
	0.47	0.47	—	6960	—	0.83	0.0075	31	31
	0.47	1.0	—	8450	—	0.67	0.0046	39	32
	0.47	2.2	—	9600	—	0.55	0.0032	45	32
300	0.1	0.1	—	974	—	4.0	0.028	37	34
	0.1	0.22	—	1404	—	3.1	0.015	57	34
	0.1	0.47	—	2169	—	2.5	0.0083	78	33
	0.22	0.22	—	2510	—	1.9	0.015	50	33
	0.22	0.47	—	4200	—	1.3	0.0074	78	33
	0.22	1.0	—	4950	—	1.1	0.0046	85	32
	0.47	0.47	—	5700	—	0.90	0.0076	57	33
	0.47	1.0	—	8720	—	0.62	0.0041	81	32
	0.47	2.2	—	9700	—	0.57	0.0030	88	32
90	0.1	0.1	—	4200	—	2.5	0.025	5.4	22
	0.1	0.22	—	4600	—	2.2	0.014	7.5	27
	0.1	0.47	—	4800	—	2.0	0.0065	9.1	30
	0.22	0.22	—	7000	—	1.5	0.013	7.3	30
	0.22	0.47	—	7800	—	1.3	0.007	10	34
	0.22	1.0	—	8100	—	1.1	0.0035	12	37
	0.47	0.47	—	12000	—	0.83	0.006	10	36
	0.47	1.0	—	14000	—	0.7	0.0035	14	39
	0.47	2.2	—	15000	—	0.6	0.002	16	41
180	0.1	0.1	—	1900	—	3.6	0.027	19	30
	0.1	0.22	—	2200	—	3.1	0.014	25	35
	0.1	0.47	—	2500	—	2.8	0.0065	32	37
	0.22	0.22	—	3400	—	2.2	0.014	24	38
	0.22	0.47	—	4100	—	1.7	0.0065	34	42
	0.22	1.0	—	4600	—	1.5	0.0035	38	44
	0.47	0.47	—	6600	—	1.1	0.0065	29	44
	0.47	1.0	—	8100	—	0.9	0.0035	38	46
	0.47	2.2	—	9100	—	0.8	0.002	43	47
300	0.1	0.1	—	1500	—	4.4	0.027	40	34
	0.1	0.22	—	1800	—	3.6	0.014	54	38
	0.1	0.47	—	2100	—	3.0	0.0065	63	41
	0.22	0.22	—	2600	—	2.5	0.013	51	42
	0.22	0.47	—	3200	—	1.9	0.0065	65	46
	0.22	1.0	—	3700	—	1.6	0.0035	77	48
	0.47	0.47	—	5200	—	1.2	0.006	61	48
	0.47	1.0	—	6300	—	1.0	0.0035	74	50
	0.47	2.2	—	7200	—	0.9	0.002	85	51

4

6AB4
12AT7/
ECC81*See Circuit
Diagram 1

5

5T8
6AT6
6CN7
6SL7GT*
6T8A
8CN7
12AT6
12SL7GT*
19T8See Circuit
Diagram 1

• One triode unit.

* Peak volts.

6

As Pentode:
5879See Circuit
Diagram 2

	E_{bb}	R_p	R_g	R_{g2}	R_k	C_{g2}	C_k	C	E_o^*	V.G.
90		0.1	0.1	0.35	1700	0.044	4.6	0.020	13	29
		0.1	0.22	0.35	1700	0.046	4.5	0.012	17	39
		0.1	0.47	0.35	1700	0.047	4.4	0.006	20	47
		0.22	0.22	0.80	3000	0.034	3.2	0.010	15	43
		0.22	0.47	0.80	3000	0.035	3.1	0.005	21	59
		0.22	1.0	0.80	3000	0.036	3.0	0.003	24	67
		0.47	0.47	1.9	7000	0.021	1.8	0.005	21	59
		0.47	1.0	1.9	7000	0.022	1.7	0.003	25	75
		0.47	2.2	1.9	7000	0.023	1.7	0.002	28	87
180		0.1	0.1	0.35	700	0.060	7.4	0.020	24	39
		0.1	0.22	0.35	700	0.062	7.3	0.012	28	56
		0.1	0.47	0.35	700	0.064	7.2	0.006	33	65
		0.22	0.22	0.80	1200	0.045	5.5	0.010	24	65
		0.22	0.47	0.80	1200	0.046	5.3	0.005	31	87
		0.22	1.0	0.80	1200	0.048	5.2	0.003	34	101
		0.47	0.47	1.9	2500	0.033	3.5	0.005	27	98
		0.47	1.0	1.9	2500	0.034	3.4	0.003	32	122
		0.47	2.2	1.9	2500	0.035	3.3	0.002	37	140
300		0.1	0.1	0.35	300	0.075	10.8	0.020	25	51
		0.1	0.22	0.35	300	0.077	10.6	0.012	32	68
		0.1	0.47	0.35	300	0.080	10.5	0.006	35	83
		0.22	0.22	0.80	600	0.056	7.9	0.010	28	81
		0.22	0.47	0.80	600	0.057	7.5	0.005	37	109
		0.22	1.0	0.80	600	0.058	7.4	0.003	41	123
		0.47	0.47	1.3	1200	0.044	5.3	0.005	34	125
		0.47	1.0	1.3	1200	0.046	5.2	0.003	42	152
		0.47	2.2	1.3	1200	0.047	5.1	0.002	48	174
90		0.047	0.047	—	1800	—	2.9	0.060	9	10
		0.047	0.1	—	2100	—	2.4	0.033	12	11
		0.047	0.22	—	2200	—	2.3	0.016	14	21
		0.1	0.1	—	3200	—	1.8	0.027	10	12
		0.1	0.22	—	3900	—	1.3	0.015	13	13
		0.1	0.47	—	4300	—	1.0	0.007	16	13
		0.22	0.22	—	6200	—	0.87	0.015	12	13
		0.22	0.47	—	8100	—	0.53	0.006	16	13
		0.22	1.00	—	9000	—	0.49	0.003	19	14
180		0.047	0.047	—	1200	—	3.5	0.063	21	12
		0.047	0.1	—	1600	—	2.6	0.033	29	13
		0.047	0.22	—	1800	—	2.4	0.016	35	13
		0.1	0.1	—	2200	—	1.9	0.031	26	13
		0.1	0.22	—	2900	—	1.35	0.015	33	14
		0.1	0.47	—	3400	—	1.1	0.007	40	14
		0.22	0.22	—	4500	—	0.92	0.015	28	14
		0.22	0.47	—	6400	—	0.61	0.006	39	14
		0.22	1.00	—	8200	—	0.52	0.003	47	14
300		0.047	0.047	—	1100	—	3.9	0.063	42	13
		0.047	0.1	—	1500	—	2.8	0.033	65	13
		0.047	0.22	—	1700	—	2.5	0.016	71	14
		0.1	0.1	—	2000	—	2.1	0.032	45	15
		0.1	0.22	—	3400	—	1.4	0.015	74	15
		0.1	0.47	—	3700	—	1.1	0.007	83	15
		0.1	0.22	—	4300	—	0.97	0.015	50	15
		0.22	0.47	—	7200	—	0.63	0.007	88	15
		0.22	1.00	—	7400	—	0.63	0.003	94	15

As Triode:

5879

See Circuit
Diagram 1

* Peak volts

E_{bb}	R_p	R_k	R_{g2}	R_k	C_{g2}	C_k	C	E_o^*	V.G.
90	0.047	0.047	—	1870	—	3.1	0.063	14	13
	0.047	0.1	—	2230	—	2.5	0.031	18	14
	0.047	0.22	—	2500	—	2.1	0.016	20	14
	0.1	0.1	—	3370	—	1.8	0.034	15	14
	0.1	0.22	—	4100	—	1.3	0.015	20	14
	0.1	0.47	—	4800	—	1.1	0.006	23	15
	0.22	0.22	—	7000	—	0.80	0.013	16	14
	0.22	0.47	—	9100	—	0.65	0.007	22	14
	0.22	1.00	—	10500	—	0.60	0.004	25	15
	180	0.047	0.047	—	1500	—	3.6	0.066	33
0.047		0.1	—	1860	—	2.9	0.055	41	14
0.047		0.22	—	2160	—	2.2	0.015	47	15
0.1		0.1	—	2750	—	1.8	0.028	35	15
0.1		0.22	—	3550	—	1.4	0.015	45	15
0.1		0.47	—	4140	—	1.3	0.007	51	16
0.22		0.22	—	5150	—	1.0	0.016	36	16
0.22		0.47	—	7000	—	0.71	0.007	45	16
0.22		1.00	—	7800	—	0.61	0.004	51	16
300		0.047	0.047	—	1300	—	3.6	0.061	59
	0.047	0.1	—	1580	—	3.0	0.032	73	15
	0.047	0.22	—	1800	—	2.5	0.015	83	16
	0.1	0.1	—	2500	—	1.9	0.031	68	16
	0.1	0.22	—	3130	—	1.4	0.014	82	16
	0.1	0.47	—	3900	—	1.2	0.0065	96	16
	0.22	0.22	—	4800	—	0.95	0.015	68	16
	0.22	0.47	—	6500	—	0.69	0.0065	85	16
	0.22	1.00	—	7800	—	0.58	0.0035	96	16

8

6FQ7/
6CG7·
6SN7GTB·
8FQ7/
8CG7·
12FQ7·
12SN7GTA·

See Circuit
Diagram 1

90	0.1	0.1	—	4400	—	2.7	0.023	5	29
	0.1	0.22	—	4700	—	2.4	0.013	6	35
	0.1	0.47	—	4800	—	2.3	0.007	8	41
	0.22	0.22	—	7000	—	1.6	0.012	6	39
	0.22	0.47	—	7400	—	1.4	0.006	9	45
	0.22	1.0	—	7600	—	1.3	0.003	11	48
	0.47	0.47	—	12000	—	0.9	0.006	9	48
	0.47	1.0	—	13000	—	0.8	0.003	11	52
	0.47	2.2	—	14000	—	0.7	0.002	13	55
	180	0.1	0.1	—	1800	—	4.0	0.025	18
0.1		0.22	—	2000	—	3.5	0.013	25	47
0.1		0.47	—	2200	—	3.1	0.006	32	52
0.22		0.22	—	3000	—	2.4	0.012	24	53
0.22		0.47	—	3500	—	2.1	0.006	34	59
0.22		1.0	—	3900	—	1.8	0.003	39	63
0.47		0.47	—	5800	—	1.3	0.006	30	62
0.47		1.0	—	6700	—	1.1	0.003	39	66
0.47		2.2	—	7400	—	1.0	0.002	45	68
300		0.1	0.1	—	1300	—	4.6	0.027	43
	0.1	0.22	—	1500	—	4.0	0.013	57	52
	0.1	0.47	—	1700	—	3.6	0.006	66	57
	0.22	0.22	—	2200	—	3.0	0.013	54	59
	0.22	0.47	—	2800	—	2.3	0.006	69	65
	0.22	1.0	—	3100	—	2.1	0.003	79	68
	0.47	0.47	—	4300	—	1.6	0.006	62	69
	0.47	1.0	—	5200	—	1.3	0.003	77	73
	0.47	2.2	—	5900	—	1.1	0.002	92	75

9

3AV6
4AV6
6AV6
6EU7·
12AV6
12AX7A/
ECC83·
20EZ7·
7025·

See Circuit
Diagram 1

10

4BQ7A/
4BZ7*
5BK7A*
5BQ7A*
6BK7B*
6BQ7A/
6BZ7/
6BS8*

See Circuit
Diagram 1

E_{bb}	R_p	R_g	R_{g2}	R_k	C_{g2}	C_k	C	E_o^*	V.G.
90	0.047	0.047	—	1580	—	4.0	0.058	9	18
	0.047	0.10	—	1760	—	3.5	0.032	13	19
	0.047	0.22	—	1820	—	3.0	0.015	16	20
	0.1	0.1	—	2920	—	2.1	0.029	12	19
	0.1	0.22	—	3570	—	1.7	0.015	17	20
	0.1	0.47	—	4020	—	1.4	0.0075	20	20
	0.22	0.22	—	6040	—	0.98	0.0135	16	19
	0.22	0.47	—	7500	—	0.78	0.0075	21	20
	0.22	1.0	—	8800	—	0.63	0.0036	25	20
180	0.047	0.047	—	694	—	6.0	0.062	25	23
	0.047	0.1	—	817	—	4.4	0.032	32	24
	0.047	0.22	—	905	—	4.0	0.0155	35	25
	0.10	0.1	—	1596	—	2.80	0.030	30	23
	0.10	0.22	—	1630	—	2.30	0.0152	32	24
	0.10	0.47	—	1860	—	2.00	0.0073	38	24
	0.22	0.22	—	3950	—	1.24	0.0150	35	22
	0.22	0.47	—	4500	—	0.96	0.0072	41	23
	0.22	1.0	—	5530	—	0.79	0.0038	49	23
300	0.047	0.047	—	438	—	6.70	0.062	38	26
	0.047	0.1	—	542	—	5.50	0.032	48	27
	0.047	0.22	—	644	—	4.30	0.016	57	27
	0.10	0.10	—	1009	—	3.5	0.031	42	25
	0.10	0.22	—	1332	—	2.5	0.015	56	26
	0.10	0.47	—	1609	—	2.1	0.0074	64	25
	0.22	0.22	—	2623	—	1.5	0.015	50	24
	0.22	0.47	—	3900	—	1.1	0.0073	70	24
	0.22	1.0	—	4920	—	0.88	0.0039	84	24

11

3BC5/
3CE5
3CB6/
3CF6
4CB6
6AG5
6BC5/
6CE5
6CB6A/
6CF6

See Circuit
Diagram 2

90	0.22	0.22	0.480	3800	0.046	5.5	0.0084	10	89
	0.22	0.47	0.480	3800	0.049	5.5	0.0054	16	114
	0.22	1.0	0.500	4400	0.045	5.3	0.0034	23	128
	0.47	0.47	1.04	7200	0.033	2.9	0.0044	10	111
	0.47	1.0	1.04	7700	0.033	2.8	0.0029	15	133
	0.47	2.2	1.10	8400	0.031	2.6	0.0020	18	152
	1.0	1.0	2.50	16000	0.018	1.4	0.0023	10	118
	1.0	2.2	2.50	18600	0.016	1.2	0.0017	11	139
	180	0.22	0.22	0.550	1600	0.072	9.5	0.0090	30
0.22		0.47	0.620	1800	0.062	8.5	0.0053	36	208
0.22		1.0	0.650	1900	0.062	8.5	0.0034	43	239
0.47		0.47	1.00	3400	0.059	6.0	0.0048	34	183
0.47		1.0	1.00	3500	0.059	6.0	0.0031	41	229
0.47		2.2	1.00	3800	0.059	5.8	0.0020	46	262
1.0		1.0	2.60	7300	0.029	2.7	0.0022	33	227
1.0		2.2	2.60	7400	0.029	2.7	0.0016	38	281
300		0.22	0.22	0.600	980	0.085	13.0	0.0085	51
	0.22	0.47	0.680	1090	0.084	12.0	0.0055	64	288
	0.22	1.0	0.700	1150	0.081	11.0	0.0033	74	334
	0.47	0.47	1.25	2000	0.064	7.9	0.0045	52	285
	0.47	1.0	1.34	2150	0.061	7.6	0.0029	67	363
	0.47	2.2	1.53	2350	0.057	7.1	0.0019	79	416
	1.0	1.0	2.60	4000	0.044	5.2	0.0023	51	334
	1.0	2.2	3.00	4700	0.038	4.3	0.0015	69	427

* One triode unit.

* Peak volts.

E_{bb}	R_p	R_g	R_{g2}	R_k	C_{g2}	C_k	C	E_o^*	V.G.
90	0.22	0.22	0.560	3700	0.046	4.50	0.0090	12	73
	0.22	0.47	0.600	3900	0.043	4.30	0.0055	17	95
	0.22	1.0	0.640	4200	0.039	4.00	0.0033	19	109
	0.47	0.47	0.870	6000	0.036	2.70	0.0046	16	95
	0.47	1.0	0.980	6700	0.044	3.00	0.0030	22	113
	0.47	2.2	1.00	6700	0.043	2.80	0.0020	25	131
	1.0	1.0	2.00	12200	0.021	1.44	0.0028	15	119
	1.0	2.2	2.20	12800	0.024	1.74	0.0016	21	167
180	0.22	0.22	0.530	1570	0.069	7.50	0.0088	32	82
	0.22	0.47	0.600	1730	0.064	7.40	0.0064	38	164
	0.22	1.0	0.650	1820	0.061	7.30	0.0034	45	190
	0.47	0.47	1.12	3200	0.053	5.30	0.0046	35	147
	0.47	1.0	1.40	3500	0.042	5.10	0.0028	40	209
	0.47	2.2	1.57	3740	0.040	5.40	0.0019	45	250
	1.0	1.0	2.50	6500	0.039	2.80	0.0024	34	179
	1.0	2.2	3.40	7500	0.026	2.30	0.0015	39	277
300	0.22	0.22	0.600	9200	0.086	11.2	0.0085	52	182
	0.22	0.47	0.670	1010	0.076	10.5	0.0052	66	236
	0.22	1.0	0.720	1100	0.076	10.0	0.0033	77	257
	0.47	0.47	1.25	1950	0.060	7.0	0.0044	41	221
	0.47	1.0	1.43	3210	0.053	6.4	0.0027	72	296
	0.47	2.2	1.45	2200	0.055	6.3	0.0019	82	345
	1.0	1.0	3.00	4100	0.040	4.2	0.0022	57	295
	1.0	2.2	3.30	4340	0.037	3.6	0.0016	74	378
90	0.047	0.047	—	1292	—	3.3	0.060	8	12
	0.047	0.1	—	1401	—	2.8	0.032	10	13
	0.047	0.22	—	1470	—	2.4	0.016	11	13
	0.10	0.1	—	2630	—	1.60	0.029	9	13
	0.10	0.22	—	3090	—	1.24	0.015	12	13
	0.10	0.47	—	3440	—	1.10	0.008	14	14
	0.22	0.22	—	6550	—	0.70	0.015	12	12
	0.22	0.47	—	8270	—	0.51	0.0077	16	12
0.22	1.0	—	9130	—	0.44	0.0045	18	12	
180	0.047	0.047	—	723	—	4.0	0.061	16	14
	0.047	0.1	—	836	—	3.5	0.032	20	14
	0.047	0.22	—	948	—	2.9	0.016	24	15
	0.10	0.1	—	1543	—	2.0	0.031	17	14
	0.10	0.22	—	2002	—	1.6	0.016	24	14
	0.10	0.47	—	2522	—	1.2	0.0082	30	13
	0.22	0.22	—	4390	—	0.79	0.015	24	13
	0.22	0.47	—	6122	—	0.57	0.0078	33	12
0.22	1.0	—	8060	—	0.47	0.0046	41	12	
300	0.047	0.047	—	534	—	4.0	0.061	27	15
	0.047	0.1	—	726	—	3.6	0.031	38	15
	0.047	0.22	—	840	—	3.0	0.015	44	15
	0.10	0.1	—	1117	—	2.3	0.031	26	15
	0.10	0.22	—	1613	—	1.7	0.0155	41	14
	0.10	0.47	—	2043	—	1.31	0.0078	51	14
	0.22	0.22	—	3133	—	0.93	0.015	36	13
	0.22	0.47	—	4480	—	0.69	0.0079	51	13
0.22	1.0	—	4930	—	0.56	0.0045	55	13	

12

7199

Pentode Unit

See Circuit Diagram 2

13

7199

Triode Unit

See Circuit Diagram 1

* Peak volts.

Replacement Guide— Entertainment Receiving Types

This guide was prepared to assist in the selection of current direct replacement tube types for foreign and domestic receiving tubes. Domestic and foreign receiving tubes are listed in numerical alphabetical sequence with the RCA type that can be used as a direct replacement. Types replaceable only by themselves are not included. Whenever possible, a defective tube should be replaced by a type having the same number, or a superseding number.

The primary considerations in selecting direct replacement tubes for this guide are: (1) mechanical interchangeability, (2) electrical interchangeability, (3) performance characteristics similar to that of the original equipment. All replacements shown are unilateral—that is the RCA tube can replace the indicated type. The reverse however, is not always permissible because of differences in electrical ratings. In some compact equipment designs, space limitations may make the suggested replacement impractical.

Type to be Replaced	Replace by RCA Type
OZ4, OZ4A, OZ4G	OZ4A/OZ4
1AE4	1L4*, 1T4*
1AF4	1U4*
1AM4	1T4

1AQ5	1R5*
1AR5	1U5
1AS5	1U5
1B3GT	1G3GTA/1B3GT
1BX2	1X2C, 1X2B

1BY2A	1A02A*
1C1	1R5
1DN5	1U5
1F2	1L4
1F3	1T4

1FD9	1S5
1G3GT, 1G3GTA	1G3GTA/1B3GT
1H33	1R5*
1J3, 1J3A	1K3A/1J3

1K3, 1K3A	1K3A/1J3
1N2, 1N2A	1G3GTA/1B3GT 1KA3A/1J3
1P10	3S4
1P11	3V4

1U6	1L6*
2A3H	2A3
2AF4, 2AF4A, 2AF4B/2DZ4	2AF4B
2AH2	2BU2/2AH2

2BA2	2AV2
2BU2	2BU2/2AH2
2C22	6J5, 6J5GT
2DZ4	2AF4B/2DZ4
2EA5	2CY5

2ER5	2GK5/2FQ5A
2ES5	2GK5/2FQ5A
2EV5	2CY5
2FQ5, 2FA5A	2GK5/2FQ5A
2FV6	2CY5

Type to be Replaced	Replace by RCA Type
2FY5	2GK5/2FQ5A
2GK5	2GK5/2FQ5A
2GU5	2FS5
2HA5, 2HK5, 2HM5	2HM5/2HA5

2T4	2AF4B/2DZ4*
3AF4, 3AF4A	3AF4A/3DZ4
3AW3	3A3C, 3DB3/3CY3,* 3DJ3

3B2	3A3C, 3DB3/3CY3,* 3DJ3
3B5	3Q5GT
3BA6	3AU6

3BC5	3BC5/3CE5
3BE6	3CS6
3BS2, 3BS2A, 3BW2/3BS2A/3BS2B, 3BT2, 3BT2A	3BT2

3BU8, 3BU8A	3BU8/3GS8
3BW2	3BW2/3BS2A/3BT2
3BY6	3CS6
3C4	3V4*
3C5GT	3Q5GT

3CB6	3CB6/3CF6
3CE5	3BC5/3CE5
3CF6	3CB6/3CF6
3CV3, 3CV3A	3A3C, 3DB3/3CY3 3DJ3

3CX3	3DA3/3DH3
3CY3	3DB3/3CY3, 3DJ3
3DA3	3DA3/3DH3
3DB3	3DB3/3CY3
3DE6	3BZ6

3DH3	3DA3/3DH3
3DZ4	3AF4A/3DZ4
3E5	3V4*
3EA5	3CY5

Type to be Replaced	Replace by RCA Type
3EH7	3EH7/XF183
3EJ7	3EJ7/XF184
3EV5	3CY5
3FH5, 3FQ5, 3FQ5A, 3FY5	3ER5*, 3GK5

3GS8	3BU8/3CS8
3GU5	3FS5*
3HA5, 3HM5	3HM5/3HA5
3HM6	3JC6A
3HT6	3JC6A

3JD6	3JC6A
3KF8	3BU8/3GS8, 3HS8
3M-R24	3DK6
3M-V7	3BZ6

3Q5, 3Q5G, 3Q5GT, 3Q5GT/G	3Q5GT
3S4, 3W4, 3Z4	3Q4*

4BA6	4AU6*
4BC5	4CB6*, 4DK6*
4BE6	4CS6
4BL8	4BL8/XCF80
4BQ7, 4BQ7A	4BQ7A/4BZ7

4BS8	4BQ7A/4BZ7
4BU8, 4BU8A	4BU8/4GS8
4BX8	4BQ7A/4BZ7
4BY6	4CS6
4BZ7	4BQ7A/4BZ7

4BZ8	4BQ7A/4BZ7, 4BC8
4CE5	4CB6*, 4DK6*
4CF6	4CB6, 4DE6, 4DK6
4EH7	4EH7/LF183

4EJ7	4EJ7/LF184
4ES8	4ES8 XCC189
4EW6	4LU6
4FQ5, 4FQ5A, 4GK5, 4FY5	

* Replacement type may not work in some circuits.

Type to be Replaced	Replace by RCA Type
4GJ7	4GJ7/XCF801
4GM6	4LU6
4GS7	4LJ8*, 5FG7*
4GS8	4BU8/4GS8
4HA5, 4HK5, 4HM5	4HM5/4HA5, 4HQ5
4HT6	4JD6, 4JC6A*
4JK6	4LU6
4JL6	4LU6
4FK8	4BU8/4GS8, 4HS8
4KN8	4KN8/4RHH8
4RHH2	4BQ7A/4BZ7
4RHH8	4KN8/4RHH8
5AR4	5AR4/GZ34
5AU4	5V3A/5AU4, 5U4GB, 5AS4A
5AV8	5B8*
5AW4	5U4GB, 5AS4A, 5AX4GT
5B8C	5BQ7A
5B8E	5BR8/5FV8*
5BR8	5BR8/5FV8
5B8S	5BQ7A
5BZ7	5BQ7A
5CG4	5AR4/GZ34, 5V4GA, 5Z4
5CM8	5KZ8
5CQ8	5CH8A, 5EA8, 5U8
5CR8	5KZ8*
5DH8	5BR8/5FV8*
5EH8	5X8*
5FV8	5BR8/5FV8, 5CL8A*
5GJ7	5GJ7/LCF801
5GX6	5HZ6
5MHH3	5J6
5MQ8	6MU8, 6HL8, 5GH8A
5RHH2	5BQ7A
5RHP1	4BL8/XCF80
5T4	5R4GB, 5AR4/GZ34
5V3, 5V3A	5V3A/5AU4
5W4, 5W4G, 5W4GT	5Y3GT, 5Z4
5X3	80
5Y4G, 5Y4GA, 5Y4GT	5U4GB, 5AS4A, 5V3A/5AU4
5Z4, 5Z4G, 5Z4GT/G, 5Z4MG	5Y3GT, 5U4GB, 5AS4A, 5V3A/5AU4
5Z10	5U4GB
6ABG, 6ABGT, 6AB8GT, 6AB8TX, 6AB8MG	6AC7, 6AC7W, 6AC7WA
6AB7, 6AB7Y	6AC7, 6AC7W, 6AC7WA
6AC7A, 6AC7Y, 6AC7W, 6AC7WA	6AC7
6AD6G, 6AF6G, 6AF6GT	6AF6G, 6AF6G

Type to be Replaced	Replace by RCA Type
6AG5WA	6AG5
6AG7Y	6AG7
6AH6WA	6AH6
6AJ4	6AM4*
6AJ7	6AC7, 6GS7*, 6SH7*
6AJ8	6AJ8/ECH81
6AK5	6AK5/EF95
6AK7	6AC7
6AK8	6AK8/EABC80
6AL3	6AL3/EY88
6AL9	6AG9
6AQ8	6AQ8/ECC85
6AR8	6JH8*
6AU7	7AU7
6AW6	6CB6A/6CF6, 6DE6, 6DC6
6B6, 6B6G	6Q7
6B8G, 6B8GT	6B8
6B32	6AL5
6BA6	6BA6/EF93
6BC5	6BC5/6CE5
6BC8	6BC8/6BZ8
6BD4, 6BD4A	6BK4C/6EL4A
6BE3, 6BE3A	6BE3/6BZ3
6BE8, 6BE8A	6BR8A/6FV8A, 6CL8A, 6FG7
6BC32	6AT6
6BD5GT	6AU5GT*, 6AV5GA*
6BK4, 6BK4A, 6BK4C	6BK4B, 6BK4C
6BK6	6AT6, 6AV6
6BK11	6K11/6BQ11*, 6AC10
6BL8	6BL8/ECF80
6BM5	6AQ5A, 6HG5
6BM8	6BM8/ECL82
6BN6	6BN6/6K56
6BQ5	6BQ5/EL84
6BQ6G, 6BQ6GA, 6BQ6GT, 6BQ6GTA, 6BQ6GTB	6BQ6GTB/6CU6
6BQ7, 6BQ7A	6BQ7A/6BZ7/6BS8
6BR3	6BR3/RK19
6BR8	6BR8A/6FV8A
6BS8	6BQ7A/6BZ7/6BS8
6BT6	6AT6, 6AV6
6BU6	6BF6
6BW3	6CG3/6BW3/6DQ3
6BW7	6HM6*, 6EJ7*, 6JC6A*
6BX8	6BC8/6BZ8, 6BQ7A/6BZ7/6BS8
6BZ3	6BE3/6BZ3
6BZ7	6BQ7A/6BZ7/6BS8
6BZ8	6BC8/6BZ8
6C4W, 6C4WA	6C4
6C5G, 6C5GT	6C5
6C8G	6F8G*
6C16	6BL8/ECF80
6C31	6K8
6CA7	6CA7/EL34
6CB6, 6CB6A	6CB6A/6CF6

Type to be Replaced	Replace by RCA Type
6CC31	6J6A
6CC43	6AQ8/ECC85
6CD3	6CE3/6CD3/6DT3
6CE3	6CE3/6CD3/6DT3
6CE5	6BC5/6CE5
6CF6	6CB6A/6CF6
6CG3	6CG3/6BW3/6DQ3
6CG6	6BA6/EF93, 6BD6
6CG7	6FQ7/6CG7
6CH3	6CJ3/6CH3
6CJ3	6CJ3/6CH3
6CK3	6CL3/6CK3
6CL3	6CL3/6CK3
6CQ4	6DE4/6CQ4
6CR8	6CM8*, 6KZ8*
6CS5	6CM6*
6CS8	6CM8*, 6KZ8*
6CU6	6BQ6GTB/6CU6
6CW5	6CW5/EL86
6D2	6AL5
6D8, 6D8G	6A8
6DA4, 6DA4A	6DM4A/6DA4
6DE4	6DE4/6CQ4
6DK3	6DL3
6DL4	6DL4/EC88
6DL5	6DL5/EL95
6DM4, 6DM4A	6DM4A/6DA4
6DQ3	6CG3/6BW3/6DQ3
6DQ4	6AX4GTB, 6DE4/6CQ4
6DQ6, 6D6A, 6DQ6B	6GW6/6DQ6B
6DT3	6CE3/6CD3/6DT3
6DT4	6AU4GTA, 6DE4/6CQ4, 6DM4A/6DQ4
6DW5	6CM6
6DX8	6DX8/ECL84
6DY5	6CW5*, 6BQ5/EL84
6EA4	6EH4A
6EA5	6EV5, 6AK5/EF95*, 6CY5
6EA7	6EM7/6EA7
6EB5	6AL5
6EC4, 6EC4A	6EC4A/EY500
6EF4	6EJ4A
6EF6	6E25*, 6W6GT*, 6DG6GT*
6EH7	6EH7/EF183
6EJ7	6EJ7/EF184
6EL4, 6EL4A	6BK4C/6EL4A
6EL7	6HM6*, 6EJ7*, 6JC6A*
6EM7	6EM7/6EA7
6ES8	6ES8/ECC189
6ET6	6DT6A*, 6GY6/6GX6*, 6HZ6*
6ET7	6KU8*
6EX6	6CD6GA
6EY6	6E25
6F5G, 6F5GT, 6F5	6F5MG
6F6, 6F6G, 6F6GT, 6F6GT/G, 6F6MG	6F6, 6F6GT

* Replacement type may not work in some circuits.

Type to be Replaced	Replace by RCA Type	Type to be Replaced	Replace by RCA Type	Type to be Replaced	Replace by RCA Type
6F10	6AC7	6J5, 6J5G,	6J5, 6J5GT	6LN8	6LN8/LCF80
6F24	6EJ7/EF184	6J5GT,		6LP12	6BM8/ECL82
6F29	6EH7/EF183	6J5GT/G,		6LQ6	6MJ6/6LQ6/ 6JE6C, 6LQ6/6JE6C
6F30	6EJ7/EF184	6J5GTX,		6LX8	6LX8/LCF802
6F31	6AU6A	6J5GX, 6J5MG		6M1	6U5
6F32	6AK5/EF95			6M7G	6K7*
6F36	6AH6	6J7, 6J7G,	6J7	6MH6	6LF6/6MH6, 6LX6*
6FG5	6FS5, 6HS6*	6J7GT,		6MHH3	6J6
6FG6, 6FG6G	6FG6/EM84	6J7GTX,		6MJ6	6MJ6/6LQ6/6JE6C
6FH6	6GW6/6DQ6B	6J7MG		6N7, 6N7G,	6N7, 6N7GT
6FQ5, 6FQ5A	6GK5/6FQ5A	6J10	6Z10/6J10	6N7GT,	
6FQ7	6FQ7/6CG7			6N7GT/G,	
6FR7	6FD7	6JB5	6JB5/6HE5	6N7MG	
6FV8, 6FV8A	6BR8A/6FV8A	6JC5	6JB5/6HE5	6P9	6AQA5, 6HG5
6FW8	6KN8/6RHH8, 6DJ8/ECC88, 6ES8/ECC189	6JC5	6HZ5/6JD5	6P15	6BQ5/EL84
6FY5	6FY5/EC97	6JE6, 6JE6A,	6MJ6/6LQ6/ 6JE6C, 6JE6C	6PL12	6BM8/ECL82
6G5	6U5	6JE6B,		6Q7, 6Q7G,	6Q7
6GA8	6FQ7/6CG7*, 6GU7*	6JE6C		6Q7GT, 6Q7MG	
6GB3A	6BQ6GTB/6CU6.	6JL6	6EW6, 6JK6, 6GM6	6Q8	6A8
6GB5	6GB5/EL500	6JN6, 6JN6A	6JN6	6Q11	6K11/6Q11
6GB6, 6GB7,	6GW6/6DQ6B	6JW8	6JW8/ECF802	6R3	6AF3, 6AL3/EY88, 6BR3/6RK19
6GB9		6K6, 6K6G,	6K6GT	6R8	6T8A
6GD7	6LJ8*, 6CG8A*, 6FG7*	6K6GT,	6K6GT/G, 6K6MG	6RHH2	6BC8/6B28
6GJ7	6GJ7/ECF801	6K7, 6K7G,	6K7	6RHH8	6KN8/6RHH8
6GJ8	6GH8A*, 6HL8, 6MU8	6K7GT,		6RK19	6BR3/6RK19
6GK5	6GK5/6FQ5A	6K7GTX,		6S5G	6E5
6GK17	6AU4GTA	6K7MG		6S7, 6S7G	6K7
6GQ7	6BC7*, 6BJ7*	6K8, 6K8G,	6K8	6SA7G,	6SA7
6GS8	6B8U8, 6HS8, 6MK8A	6K8GT, 6K8GTX		6SA7GT,	
6GU5	6FS5*	6K11	6K11/6Q11	6SA7GT/G,	
6GV8	6GV8/ECL85	6KD8	6U8A/6KD8	6SA7GTX, 6SA7GTY, 6SA7Y	
6GW6	6GW6/6DQ6B	6KF8	6B8U8, 6HS8, 6GS8, 6MK8A	6SB7,	6SB7Y
6GW8	6GW8/ECL86	6KG6A	6KG6A/EL509	6SB7GTY,	
6GX6	6GY6/6GX6	6KN8	6KN8/6RHH8	6SB7Y	
6GY6	6GY6/6GX6	6KS6	6BN6/6KS6	6SC7,	6SC7
6H5	6U5	6KS8	6AW8A, 6JV8, 6LF8, 6HF8	6SC7GT, 6SC7GTY	
6HG6, 6HG6T, 6H6	6H6GT/G, 6H6MG	6KV8	6JT8, 6KR8, 6LBB, 6LQB	6SG7,	6SG7
6H31	6BE6	6L5G	6J5, 6J5GT, 6C5	6SG7GT, 6SG7Y	
6HA5	6HM5/6HA5	6L6, 6L6A,	6L6GC	6SH7,	6SH7
6HA6	6HB6/6HA6	6L6G,		6SH7GT, 6SH7L	
6HB6	6HB6/6HA6	6L6GA,		6SJ7,	6SJ7
6HC8	6BM8/ECL82*	6L6GB, 6L6GC, 6L6GT, 6L6GA, 6L6Y		6SK7,	6SK7G
6HE5	6JB5/6HE5	6L7, 6L7G	6L7	6SK7GT,	
6HG8	6HG8/ECF86	6L10	6AG7	6SK7GT/G,	
6HK5	6HQ5	6L12	6AQ8/ECC85	6SK7GTX,	
6HK8	6BC8/6B28, 6BQ7A/6BZ7/ 6BS8, 6BK7B	6L13	12AX7A/ECC83	6SK7GTY, 6SK7Y, 6SK7W, 6SK7WA, 6SK7WGT	
6HM5	6HM5/6HA5	6L31	6AQ5A	6SL7A,	6SL7GT
6HQ6	6BZ6, 6JH6, 6GM6*	6L43	6CL6	6SL7GT, 6SL7TY, 6SL7L	
6HT6	6HM6, 6JC6A, 6JD6	6LD12	6AK8/EABC80		
6HU6	6HU6/EM87	6LF6	6LF6/6MH6, 6LF6/6LX6		
6HU8	6HU8/ELL80	6LH6, 6LH6A	6LJ6A/6LH6A		
6HZ5	6HZ5/6JD5	6LJ6, 6LJ6A	6LJ6A/6LH6A		
6HZ8	6AW8A, 6HF8, 6LF8, 6JV8				

* Replacement type may not work in some circuits.

Type to be Replaced	Replace by RCA Type
6SN7A, 6SN7GTA, 6V6GTA, 6SN7GTB, 6SN7GTY, 6SN7L	6SN7GTB
6SQ7 6SQ7G, 6SQ7GT, 6SQ7GT/G	6SQ7
6SR7, 6SR7G, 6SR7 6SR7GT	
6SS7 6SS7GT	6SK7, 6SK7GT
6S17 6S27 6T1	6SR7 6SQ7 6AF4, 6AF4A, 6DZ4
6T5	6U5
6T7G 6U4GT	6Q7 6AX4GTB, 6DM4A/ 6DQ4, 6DE4, 6CQ4, 6W4GT
6U6GT 6U7G 6U8, 6U8A 6U9 6V4	6Y6GA/6Y6G 6K7, 6I7 6U8A/6KD8 6U9/ECF201 6CA4
6V6G, 6V6GT, 6V6GTA, 6V6GT/G, 6V6GTX, 6V6GX, 6V6GTY, 6V6Y	6V6GTA
6W5G, 6W5GT 6W7G 6X5, 6X5G, 6X5GT 6X5GT/G, 6X5L, 6X5MG, 6X5W, 6X5WGT	6AX5GT, 6X5GT 6I7 6X5GT 6Y9/EFL200 6Z10/6J10
6X9 6Y6G, 6Y6GT, 6Y6GA	6X9/ECF200 6Y6GA/6Y6G
6Y9 6Z10	6Y9/EFL200 6Z10/6J10
6Z31 6Z15G 7D11 7HG8 8A8	6X4 6X5GT 6CA7/EL34 7HG8/PCF86 9A8/PCF80, 9GH8A, 9U8A
8BA8A 8BH8	8A8, 8AW8A 8A8, 8AW8A, 8JV8
8CG7 8CW5, 8CW5A 8EB8	8FQ7/8CG7 8CW5/XL86 8GN8/8EB8
8FQ7 8GJ7 8GN8 8GX7 8JE8	8FQ7/8CG7 8GJ7/PCF801 8GN8/8EB8 8GJ7/PCF801* 8CX8, 8GN8/8EB8

Type to be Replaced	Replace by RCA Type
8KS8	8A8, 8AW8A, 8JV8
9A8 9A8Q 9EA8 9GV8	9A8/PCF80 9A8Q/PC85 9GH8A, 9U8A 9GV8/XCL85
9JW8 9RAL1 9RH2 10CW5 10D2	9JW8/PCF802 10DE7, 10EW7 9GH8A 10CW5/LL86 12AL5
10DX8 10GV8 10JA8 10LZ8 10PL12	10DX8/LCL84 10GV8/LCL85 10JA8/10LZ8 10JA8/10LZ8 50BM8/UCL82
12AC6 12AD7 12AF3 12AG6 12AS5	12AF6, 12BL6 12AX7A/ECC83, 70Z5 12AF3/12BR3/12RK19 12AD6 12CA5, 12R5
12AT7 12AU7, 12AU7A 12BB14 12BC22 12BC32	12AT7/ECC81 12AU7A/ECC82 12AU7A 13GB5/XL500 12AV6 12AV6
12BD6 12BK6 12BQ6GA, 12BQ6GT, 12BA6GTA, 12BQ6GTB	12BA6 12AT6, 12AV6 12BQ6GTB/12CU6 12BQ6GT, 12BA6GTA, 12BQ6GTB
12BU6 12BR3 12BS3, 12BS3A 12BT6 12BV7	12BF6 12AF3/12BR3/12RK19 12BS3A/12DW4A 12BS3A 12AT6, 12AV6 12BY7A/12BV7/12DQ7
12BY7, 12BY7A 12C5 12CK3	12BY7A/12BV7/12DQ7 12BY7A 12CU5/12C5 12CL3, 12BS3A/ 12DW4A
12CS6 12CU5	12BE6 12CU5/12C5
12CU6 12CX6 12DF7 12DL8 12DM4, 12DM4A	12BQ6GTB/12CU6 12BL6, 12AF6 12AX7A/ECC83, 70Z5 12DS7* 12D4
12DM5 12DM7	12FX5 12AX7A/ECC83*, 70Z5*
12DQ6, 12DQ6A, 12DQ6B 12DQ7	12GW6/12DQ6B 12BY7A/12BV7/12DQ7
12DT7 12DW4A 12DZ6 12E5GT 12E13	12AX7A/ECC83, 70Z5 12BS3A/12DW4A 12EK6/12DZ6/12EA6 12J5GT 6550, 6CA7/EL34

Type to be Replaced	Replace by RCA Type
12EA6 12E05 12EH5 12EK6 12EN6	12EK6/12DZ6/12EA6 12FX5 12CA5, 12CU5/12C5 12EK6/12DZ6/12EA6 12L6GT, 12W6GT
12EX6 12F31 12FT6 12GB3 12GB6, 12GB7	12EK6/12DZ6/12EA6 12BA6 12AE6A, 12BF6 12BQ6GTB/12CU6 12GW6/12DQ6B
12GK17 12GN7, 12GN7A, 12GW6 12H31 12HG7	12D4 12HG7/12GN7A 12GN7A, 12GW6/12DQ6B 12BE6 12HG7/12GN7A
12RK19 12RL3 12RL5	12AF3/12BR3/12RK19 12AV7 12FQ7
12SA7G, 12SA7GT, 12SA7GT/G, 12SA7GTY, 12SA7Y 12SF7GT, 12SF7Y	12SA7 12SA7G, 12SA7GT/G, 12SA7GTY, 12SA7Y 12SF7 12SF7Y
12SG7GT, 12SG7Y 12SH7GT 12SJ7GT	12SG7 12SG7Y 12SH7 12SJ7
12SK7G, 12SK7GT, 12SK7GT/G, 12SK7GTY, 12SK7Y	12SK7 12SK7G, 12SK7GT/G, 12SK7GTY, 12SK7Y
12SQ7G, 12SQ7GT, 12SQ1GT/G 12SX7GT 12SY7, 12SY7GT	12SQ7 12SQ7GT, 12SQ1GT/G 12SN7GTA 12SA7 12SY7GT
13D2 13EM7 13FM7 13FR7 13GB5	6SN7GTB 13EM7/15EA7 13FM7/15FM7 13FD7 13GB5/XL500
13J10 13Z10 14JG8 15CW5 15DQ8	13Z10/13J10 13Z10/13J10 14GT8 15CW5/PL84 15DQ8/PCL84
15EA7 15EW7 15FM7 15MX8 16A5	13EM7/15EA7 13DE7 13FM7/15FM7 15KY8A 15CW5*
16A8 16AQ3 16MY8 17A 17AB10	16A8/PCL82 16AQ3/XY88 16LU8A 17A 17AB10/17X10
17BE3 17BQ6GTB 17BR3 17BS3, 17BS3A	17BE3/17BZ3 17GW6/17DQ6B 17BR3/17RK19 17BS3, 17BS3A/17DW4A

* Replacement type may not work in some circuits.

Type to be Replaced	Replace by RCA Type	Type to be Replaced	Replace by RCA Type	Type to be Replaced	Replace by RCA Type
17BZ3	17E3/17BZ3	30PL13,	16GK6	B65	6SN7GTB
17C5	17CU5/17C5	30PL14		B152	12AT7/ECC81
17CL3	17CK3, 17BS3A/ 17DW4	32ET5,	34GD5A	B309	12AT7/ECC81
17CU5	17CU5/17C5	32ET5A		B329	12AU7A/ECC82
17DQ4	17DM4A, 17D4			B339	12AX7A/ECC83
17DQ6,	17GW6/17DQ6B	35Z5, 35Z5G,	35Z5GT	B719	6AQ8/ECC85
17DQ6A,		35Z5GT/G		B739	12AT7/ECC81
17DQ6B		36KD6	36KD6/40KD6	B749	12AU7A/ECC82
17D4A	17BS3A/17D4A	40KD6	36KD6/40KD6	B759	12AX7A/ECC83
17EW8	17EW8/HCC85	40KG6,	40KG6A/PL509	BPM04	6AQ5A
17GW6	17GW6/17DQ6B	40KG6A		CK1003	OZ4A/OZ4
17J6	17JG6A	42EC4,	42EC4A/PY500	CSF80	4BL8/XCF80
17L08	15KY8A	42EC4A		CV1758,	
17RK19	17BR3/17RK19	48A8	50BM8/UCL82	CV2742,	1L4
17X10	17AB10/17X10			C2795	
17Z3	17Z3/PY81	50BM8	50BM8/UCL82	D2M9, D27	6AL5
18GB5	18GB5/LL500	50CA5	50EH5	D63	6H6
18GE6,	18FY6A	52KU, 53KU,	5Y3GT	D77, D152,	6AL5
18GE6A		54KU		D717	
18GV8	18GV8/PCL85	58HE7	53HK7	DAF92	1U5
19C8	19T8	77	6C6	DD6	6AL5
19CG3	19CG3/19DQ3	274	5V4GA	DF91	1T4
19CL8A	19JN8/19CL8A	310A, 328A	6C6	DF92	1L4
19DQ3	19CG3/19DQ3	349A	6K6GT	DF904	1U4
19JN8	19JN8/19CL8A	351A	6X5GT	DH63	6Q7
19MR9,	18GD6A	403A	6AK5/EF95	DH77	6AT6
19MR10		731A	6AK5/EF95	DH719	6AK8/EABC80
19MR19	18FW6A	1217	6BE6	DK91	1R5
20AQ3	20AQ3/LY88	1221	6C6	DL33	3Q5GT
21EX6	25CD6GB, 25DN6	1225	6L7	DL37	6L6GC
21JS6A	23JS6A	1381HQ	6AK5/EF95	DL94	3V4
21MY8	21LU8	1611	6F6, 6F6GT	DL95	3Q4
24JE6,	24LQ6/24JE6C	1613	6F6, 6F6GT	DLO12	6T8A
24JE6A,		1649	6AC7	DP61	6AK5/EF95
24JE6B		1655	6SC7	DY30	1G3GT/1B3GT
24LQ6	24LQ6/24JE6C	1852	6AC7	DY80	1X2C, 1X2B
25BQ6GA,	25BQ6GTB/25CU6	2057/6H6	6H6	E81CC	12AT7/ECC81
25BQ6GT,		3107	5V4GA	E82CC	12AU7A/ECC82
25BQ6GTB		4707	6X4	E83CC	12AX7A/ECC83
25CA5	25C5, 25EH5	5661	12SK7	E90F	6BH6
25CU6	25BQ6GTB/25CU6	5693	6S17	E90Z	6X4
25E5	25E5/PL36	5871	6V6GT	E95F	6AK5/EF95
25EC6	25CD6GB	5910	1U4	E99F	6B16
25GB6	25BQ6GTB/25CU6	5931	5U4GB	E902	6X4
25L6, 25L6G,	25L6GT/25W6GT	5932	7027A	E902	6X4
25L6GT,		5992	6V6GTA	E2157	12AT7/ECC81
25L6GT/G		6087	5Y3GT	E2163	12AU7A/ECC82
25W6GT	25L6GT/25W6GT	6100	6C4	E2164	12AX7A/ECC83
25Z6,	25Z6GT	6106	5Y3GT	EEA91	6AL5
25Z6GT/G,		6113	6SL7GT	EABC80	6AK8/EABC80,
25Z6MG		6134	6AC7		6T8A
27GB5	27GB5/PL500	6135	6C4	EB34	6H6
28GB5	27GB5/PL500	6853	5Y3GT	EB91	6AL5
29KQ6	29KQ6/PL521	6968	6AK5/EF95	EBC90	6AT6
30A5	35EH5	7700	6C6	EBC91	6AV6
30AE3	30AE3/PY88	7717	6CY5	EBC92	6B8
30C1	9AB/PCF80	7724	14GT8	EC88	6DL4/EC88
30P4	25E5/PL36	7732	6CB6A/6CF6	EC90	6C4
30P18	15CW5/PL84	7733	12BY7A/12FV7/12DQ7	EC92	6AB4
30P19	25E5/PL36	8016	1G3GT/1B3GT	EC94	6AF4, 6AF4A
30PL12	16A8/PCL82	A61	17Z3/PY81	EC95	6ER5
		A677	6C6	EC97	6FY5/EC97,
		A863	6J7		6ER5
		A2900	12AT7/ECC81	EC900	6HM5/6HA5
		B36			

* Replacement type may not work in some circuits.

Type to be Replaced	Replace by RCA Type
ECC32	6SN7GTB
ECC35	6SL7GT
ECC81	12A77/ECC81
ECC82	12AU7A/ECC82
ECC83	12AX7A/ECC83
ECC85	6AQ8/ECC85
ECC88	6ES8/ECC189
ECC91	6J6A
ECC180	6BQ7A/6BZ7/6BS8
ECC186	12AU7A/ECC82
ECC189	6ES8/ECC189
ECC801	12A77/ECC81
ECC802	12AU7A/ECC82
ECC803	12AX7A/ECC83
ECC900	6HM5/6HA5
ECF80	6BL8/ECF80
ECF82	6U8A
ECF86	6HG8/ECF86
ECF200	6X9/ECF200
ECF201	6U9/ECF201
ECF801	6GJ7/ECF801
ECF802	6JW8/ECF802
ECH42	6C10
ECH81	6AJ8/ECH81
ECL82	6BM8/ECL82
ECL84	6DX8/ECL84
ECL85	6GV8/ECL85
ECL86	6GW8/ECL86
ECL100	6BQ7A/6BZ7/6BS8
ECL180	6BQ7A/6BZ7/6BS8
ED2	6AL5
EF36, EF37	6J7*
EF39	6K7
EF93	6BA6/EF93
EF94	6AU6A
EF95	6AK5/EF95
EF96	6AG5
EF183	6EH7/EF183
EF184	6EJ7/EF184
EF190	6BZ6
EF811	6EH7/EF183
EF814	6EJ7/EF184
EF905	6AK5/EF95
EFL200	6Y6/EFL200
EH90	6CS6
EK90	68E6
EL34	6CA7/EL34
EL36	6GW6/6DQ6B*
EL37	6L6GC
EL84	6BQ5/EL84
EL86	6CW5/EL86
EL90	6AQ5A
EL95	6DL5/EL95
EL180	12BY7A/12BV7/12DQ7
EL500	6GB5/EL500
EL505, EL509	6KG6A/EL509
ELF86	6HG8/ECF86
ELL80	6HU8/ELL80
EM35	6U5
EM84	6FG6/EM84
EM87	6HU6/EM87
EM840	6FG6/EM84
EY83	6AL3/EY88
EY88	6AL3/EY88
EY500	6EC4A/EY500

Type to be Replaced	Replace by RCA Type
EZ4	6CA4
EZ35	6X5GT
EZ81	6CA4
EZ90, EZ900	6X4
G77	6C6
GZ30	5Y3GT
GZ31	5U4GB
GZ32	5V4GA
GZ34, GZ37	5AR4/GZ34
H52	5U4GB
H63	6F5
H250	6C6
HAA91	12AL5
HABC80	19T8
HBC90	12AT6
HBC91	12AV6
HCC85	17EW8/HCC85
HD93	1X2B, 1X2C
HD94	6BQ6GTB/6CU6
HD96	25BQ6GTB/25CU6
HF93	12BA6
HF94	12AU6
HK90	12BE6
HL92	50C5
HM04	6BE6
HY90	35W4
HY145	1U4
HZ90	12X4
KT32	25L6GT/25W6GT
KT63	6F6, 6F6GT
KT66	6L6GC, 7027A*
KT71	50L6GT
KT77	6CA7/EL34
KTW63	6K7
KTZ63	6J7
L63	6J5, 6J5GT
L77	6C4
LC97	3GK5
LC900	3HM5/3HA5
LCF80	6LN8/LCF80
LCF86	5HG8/LCF86
LCF201	5U9/LCF201
LCF801	5GJ7/LCF801
LCF802	6LX8/LCF802
LCL82	11BM8
LCL84	10DX8/LCL84
LCL85	10GV8/LCL85
LCL200	10DX8/LCL84
LF183	4EH7/LF183
LF184	4EJ7/LF184
LL86	10CW5/LL86
LL500	18GB5/LL500
LL521	21KQ6
LN119	50BM8/UCL82
LY88	20AQ3/LY88
LZ319, LZ329	9A8/PCF80
M8080	6C4
M8081	6J6A
M8101	6BA6/EF93
M8136	12AU7A/ECC82
M8137	12AX7A/ECC83
M8162	12A77/ECC81
M8245	6AQ5A
MV6-5	6SA7
N15, N16	3Q5GT

Type to be Replaced	Replace by RCA Type
N18	3Q4
N19	3V4
N30EL	6LF6
N63	6F6, 6F6GT
N66	6K6GT
N77	6L6GC
N308	25E5/PL36
N369	16A8/PLC82
N378, N379	15CW5/PL84
N709	6BQ5
N727	6AQ5A
OB3	12SQ7
OM3	6H6
OM6	6K7
OSW2190	6AC7
OSW2192	6AG7
OSW2600	6AC7
OSW2601	6AG7
OSW3104	6SA7
OSW3105	6SQ7
OSW3106	6V6, 6V6GTA
OSW3107	5AR4/GCZ34, 5V4GA, 5Z4
OSW3109	6H6
OSW3110	6E5
OSW3111	6SK7, 6SK7GT
OSW3112	6J5, 6J5GT
PC95, PC97	4GK5
PC900	4HM5/4HA5
PCC18	7AU7
PCC85	9AQ8/PCC85
PCC186	7AU7
PCF80	9A8/PCF80
PCF82	9U8A
PCF86	7HG8/PCF86
PCF801	8GJ7/PCF801
PCF802	9JW8/PCF802
PCF806	8GJ7/PCF801
PCL82	16A8/PCL82
PCL84	15DQ8/PCL84
PCL85	18GV8/PCL85
PCL800	16GK6
PF9	6K7
PH4	6A8
PL36	25E5/PL36
PL84	15CW5/PL84
PL500	27GB5/PL500
PL505, PL509	40KG6A/PL509
PL521	29KQ6/PL521
PM04	6BA6
PM05	6AK5/EF95*
PY81, PY83	17Z3/PY81
PY88	30AE3/PY88
PY500	42EC4/PY500
PY800, PY801	17Z3/PY81
QA2401	6C4
QA2404	6AL5
QA2406	12A77/ECC81
QB65	6SN7GTB
QB309	12A77/ECC81
QL77	6C4
R19	1X2B, 1X2C
R52, RJ2, RS2	5Y3GT
T2M05	6J6A
TT263	6J7

* Replacement type may not work in some circuits.

Type to be Replaced	Replace by RCA Type
U41	1G3GT/1B3GT
U50, U51	5Y3GT
U52	5U4GB
U54	5AR4/GZ34
U77	5AR4/GZ34
U78	6X4
U147	6X5GT
U153, U193, U251, U349	17Z3/PY81
U707	6X4
U709	6CA4
UCL82	50GM8/UCL82
UJ12	6CA4
VZM70	6X4
V153	17Z3/PY81
V741	6C4
VSM70	6X4
W17	17A
W61, W63	6N7GT
W147	6K7
W727	6BA6
WT210-0006	6H6
WT210-0007	6L6, 6L6GC
WT210-0021	6X5GT
WT210-0028	3Q5GT
WT210-0029	6C5
WT210-0042	5Y3GT
WT210-0048	5U4GB
WT210-0060	OZ4A/OZ4
WT210-0081	6SJ7

Type to be Replaced	Replace by RCA Type
WT210-0082	6V6, 6V6GTA
WT210-0084	6N7, 6N7GT
WT210-0085	50B5
WT210-0087	6K8
WT210-0088	6J5, 6J5GT
WT210-0090	6C6
WT210-0148	6AX5GT
WT261,	6H6
WT261A	
WT308	6X5GT
WT389	3Q5GT
WT390	6C5
WTT102	5Y3GT
WTT103	6H6
WTT114	OZ4A/OZ4
WTT122	6SJ7
WTT123	6V6, 6V6GTA
WTT124	6AT6
WTT125	6N7, 6N7GT
WTT126	50B5
WTT128	6K8
WTT129	6J5, 6J5GT
WTT131	6C6
WTT135	5U4GB
X17	1R5
X63	6A8
X64	6L7
X77	6BE6
X107	18FX6*
X150	6C10
X155	68C8/6BZ8

Type to be Replaced	Replace by RCA Type
X719	6AJ8/ECH81
X727	6BE6
XAA91, XB91	3AL5
XC95, XC97	2GK5/2FQ5A
XC900	2HM5/2HA5
XCC82	7AU7
XCC189	4ES8/XCC189
XCF80	4BL8/XCF80
XCF82	5U8
XCF801	4GJ7/XCF801
XCL85	9GV8/XCL85
XF94	3AU6
XF183	3EH7/XF183
XF184	3EJ7/XF184
XL84	8BQ5
XL86	8CW5/XL86
XL500	13GB5/XL500
XXA91	3AL5
XY88	16AQ3/XY88
Y61, Y64	6U5
YC95	3ER5
YC97	3GK5
YCF86	5HG8/LCF86
YCL180	5BQ7A
YCL84	10DX8/LCL84
YF183	4EH7/LF183
YF184	4EJ7/LF184
YL84	10BQ5
YL86	10CW5/LL86
Z63	6J7

* Replacement type may not work in some circuits.

Replacement Guide—Industrial Receiving Types

How to Use

This guide was prepared to assist in the selection of current replacement types for foreign and domestic industrial receiving tubes. The first column lists in numerical-alphabetical sequence the type designation of the industrial receiving tube types to be replaced. The next two columns give the RCA Replacement Types. The column under the heading "Direct" gives direct replacements for the type in the left hand column. The column under the heading "Similar" gives the types that are similar in many respects to the type to be replaced but which are not directly interchangeable because of differences in mechanical and/or electrical characteristics. For more information as to the degree of interchangeability of "Similar" types, refer to the data for the respective tube types.

Types replaceable only by themselves are not included.

Type to be Replaced	RCA Replacement		Type to be Replaced	RCA Replacement	
	Direct	Similar		Direct	Similar
0A2	0A2, 0A2WA 6073, 6073/ 0A2 6626/0A2WA		2C51	5670	
0A2WA	0A2WA, 6626/ 0A2WA	0A2, 6073, 6073/0A2	2D21	2D21, 5727	
0A3, 0A3/VR75	0A3, 0A3A		2D21W	5727	2D21
0A3A	0A3A	0A3	5R4G, 5R4GT, 5R4GB 5R4G, 5R4GYA, 5R4GYB		5U4GB
0B2	0B2, 0B2WA 6074, 6074/ 0B2		6AC7W, 6AC7WA, 6AC7Y		6AC7
0B2WA	0B2WA	0B2, 6074, 6074/0B2	6AG5WA		6AG5
0C3, 0C3/VR105	0C3, 0C3A		6AG7Y		6AG7
0C3A	0C3A	0C3	6AH6WA	6AH6WA	6AH6
0C3W		0C3, 0C3A	6AK5W	5654	6AK5/EF95
0D3, 0D3/VR150	0D3, 0D3A		6AL5W	5726	6AL5, 6663/ 6AL5
0D3A	0D3A	0D3	6AQ5W	6005	6AQ5A
0D3W		0D3, 0D3A	6AS6, 6AS6W	5725, 6AS6	
0G3	5651A		6AS7G	6AS7G, 6AS7GA, 6080, 6080WA	
1C21	1C21, 5823		6AS7GA	6AS7GA, 6080, 6080WA	6AS7G
1F2	1L4		6AS7GYB		6AS7G, 6AS7GA, 6080, 6080WA
1G50		2050, 2050A	6AU6WA, 6AU6WB	6AU6WB	6136
1G84		884			
2C22		6J5, 6J5GT			

Type to be Replaced	RCA Replacement		Type to be Replaced	RCA Replacement	
	Direct	Similar		Direct	Similar
6BA6W	5749	6BA6/EF93, 6660/6BA6	150C1, 150C2	0A2, 0A2WA, 6073, 6073/0A2 6626/0A2WA	
6BE6W	5750	6BE6	150C3	0D3, 0D3A	
6CC10	5692		150C4	0A2WA, 6073, 0A2 6073/0A2, 6626/0A2WA	
6D2		5726	180C1	0B2, 0B2WA, 6074, 6074/0B2	
6DJ8	6DJ8/ECC88	6ES8/ECC189	245	884	
6J4	6J4, 8532		274A, 274B	5R4GB	
6J4WA	8532	6J4	301A	83	
6J6W, 6J6WA	6J6WA, 5964, 6101	6J6A	310B		1620
6L6W, 6L6WA, 6L6WGA, 6L6WGB, 6L6WGT, 6L6Y		5881, 6L6CC	313C		1C21
6MH1		6J4	328A		6C6
6RR8, 6RR8C	5847/404A		348A		1620
6SA7Y		6SA7	349A		6F6, 6F6GT, 6K6
6SG7Y		6SG7	351A		6X5GT
6SJ7WGT, 6SJ7Y, 6SJ7WGTY, 6SJ7W	5963	6SJ7	359A		1C21
6SL7W, 6SL7WGT	5691	6SL7GT	395A		5823
6SN7GTY, 6SN7W, 6SN7WGT, 6SN7WGTA	5692	6SN7GTB	403A, 403B	6AK5/EF95, 5654	
6V6Y, 6V6GTY		6V6GTA, 6V6	404A	5847/404A	
6X4W	6X4W, 6202	6X4	409A	6AS6	
6Z31		6202	417A	5942/417A	
7D11		6550	421, 421A		6AS7G, 6AS7GA, 6080
12AT7WA	12AT7WA, 12AT7WB	6201, 6679/ 12AT7	423A		5651A, 5651WA
12AT7WB	12AT7WB	12AT7WA, 6201, 6679/12AT7	502A	2050, 2050A	
12AU7WA	6189	6670/12AU7A, 5814A, 12AU7A/ECC82	630, 630A	2050, 2050A	
12AX7WA	6681/12AX7A	12AX7A/ECC83	885		884
12E13		6550	954		9001
12SA7Y		12SA7	956		9003
12SG7Y		12SG7	958A		9002
12SK7Y		12SK7	1217		5915
20A3		2021	1219	567D	
25B6G	5824		1221		6C6
26A6	26A6		1223		1620
26A7GT	26A7GT		1225		6L7
85A3		5783	1266		5823
108C1	0B2, 0B2WA	0C3, 0C3A	1267	0A4G	
			1381HQ	6AK5/EF95, 5654	
			1603		6C6
			1611	1621	6F6, 6F6GT
			1612	1612	6L7
			1613	1621	6F6, 6F6GT
			1614	1614	6L6, 6L6CC

Type to be Replaced	RCA Replacement		Type to be Replaced	RCA Replacement	
	Direct	Similar		Direct	Similar
1620	1620	6J7	5751WA		5751, 6681/ 12AX7A
1621	1621	6F6, 6F6GT	5812		5763
1622	1622	6L6, 6L6GC	5814, 5814A	5814A	12AU7A/ECC82, 6189
1629	1629	6E5	5814WA		5814A, 6189
1631		1614, 6L6, 6L6GC, 1622	5840, 5840A, 5840W	5840W	5840
1649		6AC7	5842, 5842/ 417A	5842/417A	
1650	955		5844		5964, 6J6A
1655		6SC7	5871		6V6GT
1657, 1665		2050, 2050A	5881	5881	6L6GC
1852		6AC7	5897	5718	
2013	6211		5899, 5899A, 5900	5899	
2014	6197	6CL6, 6677/6CL6	5901	5840W	5915
2050	2050	2050A	5910		1U4
2050A	2050A	2050	5915, 5915A	5915	
2051	2050	2050A	5920		5964, 6J6A, 6101
2057/6H6		6H6	5931		5U4GB
12AY7	12AY7	2082/12AY7	5932		7027A
2081, 2081/6AW8A	2081/6AW8A	6AW8A	5963	5963	5814A, 12AU7A/ECC82, 6680/12AU7A
2082, 2082/12AY7	2082/12AY7	12AY7	5964	5964	6J6WA, 6101
5590/401B 5591/403B		5654, 6AK5/EF95	5965A		5965
5636A		5636	5992		6V6GTA
5651, 5651A	5651A, 5651WA		6005, 6005/ 6AQ5W, 6005/ 6AQ5W/ 6095	6005	6AQ5A
5651WA	5651WA	5651A	6012	6012	5727
5654, 5654/6AK5W	5654	6AK5/EF95	6028, 6028/ 408A	408A	
5659		12A6	6058		5726, 6AL5
5663	5663	5696, 5696A	6060		6201
5670WA		5670	6062		5763
5691	5691	6SL7GT	6063		6X4W
5692	5692	6SN7GTB	6067		5814A, 12AU7A/ECC82, 6680/12AU7A
5693	5693	6SJ7	6072	6072, 6072A	12AY7, 2082/12AY7
5696	5696	5696A	6072A	6072A	12AY7, 2082/12AY7, 6072
5696A	5696A	5696	6073, 6073/ OA2	6073, 6626/ OA2WA, 6073/ OA2	OA2, OA2WA
5725, 5725/6AS6W	5725	6AS6			
5726/6AL5W	5726	6663/6AL5, 6AL5			
5727, 5727/2D21W	5727	2D21			
5731	955				
5734	5734				
5749, 5749/6BA6W	5749	6BA6/EF95			
5750	5750	6BE6			
5751	5751	6681/12AX7A			

Type to be Replaced	RCA Replacement		Type to be Replaced	RCA Replacement	
	Direct	Similar		Direct	Similar
6074, 6074/ OB2	6074, 6074/ OB2	OB2, OB2WA	6550	6550	7027A
6080	6080, 6080WA	6AS7G, 6AS7GA	6626/OA2WA, 6626	6626/OA2WA	02A, 6073, 6073/OA2
6080WA	6080WA	6080, 6AS7G, 6AS7GA	6627		OB2, OB2WA, 6074, 6074/OB2
6082	6082, 6082A		6660/6BA6, 6660	6660/6BA6	5749, 6BA6/EF93
6082A		6082	6661/6BH6, 6661	6661/6BH6	6BH6
6084		5879	6662/6BJ6, 6662	6662/6BJ6	6BJ6
6085		5962, 6SN7GTB	6663/6AL5, 6663	6663/6AL5	5726, 6AL5
6087		5Y3GT	6664/6AB4, 6664	6664/6AB4	6AB4
6094		6005, 6AQ5A	6669/6AQ5A, 6669	6669/6AQ5A	6005, 6AQ5A
6095	6005	6AQ5A	6676/6CB6A, 6676	6676/6CB6A	6CB6A/6CF6
6096		5654, 6AK5/EF95	6677/6CL6, 6677	6677/6CL6, 6197	6CL6
6097		5726, 6AL5, 6663/6AL5	6678/6U8A, 6678	6678/6U8A	6U8A/6KD8
6099		5964, 6101, 6J6WA	6679/12AT7, 6679	6679/12AT7	12AT7WA, 12AT7WB
6100		6C4	6680/12AU7A, 6680	6680/12AU7A	12AU7A/ECC82
6101, 6101/ 6J6WA	6101	5964, 6J6WA	6681/12AX7A, 6681	6681/12AX7A	12AX7A/ECC83
6106		5Y3GT	6687		5915
6113		6SL7GT	6829		5965
6134		6AC7	6853		5Y3GT
6135		6C4	6922/E88CC, 6922	6922/E88CC	
6136	6136	6AU6WB	6968		6AK5/EF95
6140/423A		5651A	7000		1620
6180		5692, 6SN7GTB	7025, 7025A	7025	12AX7A/ECC83
6186, 6186/ 6AG5WA		6AG5	7036		5915
6187	6AS6	5725	7054	7054, 8077/ 7054	
6189, 6189/ 12AU7WA	6189	5814A, 5963, 12AU7A/ECC82, 6680/12AU7A	7062		5965
6197	6197	6CL6, 6677/ 6CL6	7105		6080, 6080WA, 6AS7G, 6AS7GA
6201	6201	12AT7WA, 12AT7WB, 6679/12AT7	7184		6V6, 6V6GTA
6202	6202	6X4W	7244, 7244A		5964, 6101, 6J6WA
6211A		6211	7245, 7245A		6J4, 8532
6336, 6336A, 6337	6336A		7318		5814A, 6680/12AU7A, 12AU7A/ECC82
6360	6360, 6360A				
6360A	6360A	6360			
6385		5670			
6394		6082			
6414		5965			
6417	6417	7551			
6486, 6486A		5725, 6AS6			
6520		6AS7G, 6AS7GA			

Type to be Replaced	RCA Replacement		Type to be Replaced	RCA Replacement	
	Direct	Similar		Direct	Similar
7370		5687	B739		6679/12AT7, 12AT7WA
7494		12AX7A/ECC83, 6681/12AX7A	B749		5814, 6189, 6680/12AU7A
7543		6AU6WB	B759		5751
7645	6939		BA2		2050
7700		6C6	CC81E	12AT7WA, 12AT7WB, 6201	6679/12AT7, 12AT7/ECC81
7701		7551	CCa	6922/E88CC	
7717		6CY5	CV216	OD3, OD3A	
7724		14GT8	CV618		83
7728	6201		CV686	OC3, OC3A	
7729		6681/12AX7A, 12AX7A/ECC83	CV752	0A4G	
7730		6189, 5814A, 6680/12AU7A	CV797	2D21, 5727	
7731		6678/6U8A, 6U8A/6KD8	CV807	3A4	
7732		6CB6A/6CF6	CV1758	1L4	
7733		12BY7A/12BV7/ 12DQ7	CV1832	0A2, 0A2WA, 6073, 6073/OA2, 6626/OA2WA	
7752		6AS6	CV1833	0B2, 0B2WA, 6074, 6074/OB2	
8016	1G3GTA/1B3GT		CV1834	6AS7G, 6AS7GA, 6080, 6080WA	
8077, 8077/ 7054	8077/7054	7054	CV1992	0A4G	
8136	8136	6DK6	CV2129	5763	
8162	12AT7WA	12AT7/ECC81	CV2240		3B4WA
8196	5754	6AS6	CV2241	5642	
8203	8203		CV2390	3A4	
8204	5727	2D21	CV2466	6939	
8380	7587		CV2492	6922/E88CC	
8382	7586		CV2522	6AS6, 5725	
8441	7895		CV2573	5651A, 5751WA	
8532, 8532/ 6J4WA	8532	6J4	CV2642	5842/417A	
8556	8056		CV2742, CV2795	1L4	
8627	8627	8627A	CV2876	5727	2D21
8627A	8627A	8627	CV2984	6080, 6080WA	6AS7G, 6AS7GA
A1834	6080, 6080W	6AS7G, 6AS7GA	CV3508	6201	12AT7WA, 12AT7WB, 6679/12AT7
AA91E	5726	6AL5, 6663/ 6AL5	CV3512	5696, 5696A	
ABC91	12A6		CV3789	5842/417A	
AG5210	0B2, 0B2WA, 6074, 6074/OB2		CV3798	0A3, 0A3A	
AG5211	0A2, 0A2WA, 6073, 6073/OA2 6626/OA2WA		CV3928	5636	5840W
ASG512, ASG5121	2D21, 5727		CV3930	5718	
B339		5751, 6681/ 12AX7A	CV3986	6021	
			CV4009	5749	6BA6/EF93
			CV4011	5725	6AS6

Type to be Replaced	RCA Replacement		Type to be Replaced	RCA Replacement	
	Direct	Similar		Direct	Similar
CV4017	5751	6681/12AX7A, 12AX7A/ECC83	E810F		7788
CV4018	5727	2D21	E1955	2D21, 5727	
CV4020	0A2WA	0A2	EAA901, EAA901S	5726	6AL5, 6663/6AL5
CV4023	6AU6WB	6AU6A	EC70, EC71	5718	
CV4024	12AT7WA, 12AT7WB	6679/12AT7	ECC70	6021	
CV4025	5726	6AL5, 6663/6AL5	ECC88	6D18/ECC88	
CV4028	0B2WA	0B2, 6074, 6074/0B2	ECC91		6101
CV4031	6101	6J6WA	ECC230	6080, 6080WA	6AS7G, 6AS7GA
CV4039	5763		ECC801	6201	
CV4048	5651A, 5651WA		ECC802, ECC802S	6189	6680/12AU7A, 12AU7A/ECC82
CV4100	0A2WA, 6626/0A2WA	0A2, 6073, 6073/0A2	EF71	5899	
CV4101	0B2WA	0B2, 6074, 6074/0B2	EF72	5840W	
CV5122	5823		EF93		5749, 6660/6BA6
CV5186	5651A, 5651WA		EF94		6136
CV5212	6201	12AT7WA, 12AT7WB, 6679/12AT7	EF95	5654	6AK5/EF95
D2M9		5726	EF730	5636	
DM160		6977	EF731	5899	
D77, D152, D717		5726	EF732		5840
DCC90	3A5		EF905	5654	6AK5/EF95
DD6, DD6G		5726	EH900S		5915
DD77	5726				5750
DF92	1L4		EL3/		5881, 6L6GC
DL93	3A4		EN32	2050, 2050A	
DL98		3B4WA	EN91	2D21, 5727	
DP61	5654		EN92	5696, 5696A	
DY70	5642		EZ90		6202
E55L		8233	G/50/4K		0A2
E81CC	6201, 12AT7WA	6679/12AT7, 12AT7/ECC81	375/2D		0A3
E81L		6686	G105/1D		0C3
E82CC	5814A, 6189	6680/12AU7A 12AU7A/ECC82	G150/3D		0D3
E83CC		6681/12AX7A 12AX7A/ECC83	GL546		5696, 5696A
E88CC	6922/E88CC		GQ5G	884	
E91AA	5726	6AL5, 6663/6AL5	HD51	0A2, 0A2WA, 6073, 6073/0A2, 6626/0A2WA	
E91H		5915	HD52	0B2, 0B2WA, 6074, 6074/0B2	
E91N	5727	2D21	HM04		5750
E95F	5654	6AK5/EF95	KD21		0A3
E180F		6688A	KD24	0C3, 0C3A	
E182F	5847/404A		KD25	0D3, 0D3A	
E188CC		7308	KT66		5881
			KT88		6550
			M8079	5726	6663/6AL5, 6AL5
			M8081	6101	6J6WA

Type to be Replaced	RCA Replacement		Type to be Replaced	RCA Replacement	
	Direct	Similar		Direct	Similar
M8096	5763		QS1211	OB2WA	OB2, 6074, 6074/OB2
M8098	5651A		QS2406	6201	12AT7WA, 12AT7WB, 6679/12AT7
M8100	5654	6AK5/EF95	QS2404	5726	6AL5
M8101		5749, 6660/6BA6	QS2406	6201	12AT7WA, 12AT7WB
M8136	6189/12AU7WA	12AU7A/ECC82, 5814	RL21	2D21, 5727	
M8137		5751	RL1267	0A4G	
M8138		6202	S856	0A2, 0A2WA, 6073/OA2, 6626/OA2WA	
M8162	6201	6679/12AT7	S860	OB2, OB2W, 6074, 6074/OB2	
M8180	5654	6AK5/EF95	STV85/10	5651A	
M8190		5783	STV108/30	OB2, OB2WA, 6074, 6074/OB2	
M8196		5725	STV150/30	0A2WA, 6627/OA2WA, 6073/OA2	OA2
M8204		5727	T2M05		6101
M8212	5726, 6663/6AL5	6AL5	T60	8005	
M8223	0A2WA, 6627/OA2WA	OA2, 6073, 6073/OA2	T66G-GT, TY66G		884
M8824	OB2WA	OB2, 6074, 6074/OB2	U78		6202
M8245	6005	6AQ5A	VR75	0A3, 0A3A	
ME1501	2050		VR105	0C3, 0C3A	
NE48	991		VR150, VR150W	0D3, 0D3A	
PL21	5727	2D21	VT83		83
PL1267		0A4G	VT138	1629	6E5
PM04		5749	VT139	0D3, 0D3A	
PM05	5654	6AK5/EF95	VT202	9002	
QA2404		5726	VT203	9003	
QA2408	5692	6SN7GTB	W727		5749
QE03/10, QV03-12	5763		WL630, WL630A	2050	
QM556		6X4W	WT6	1614	6L6, 6L6GC
QQEQ2/5, QQV02-6	6939		WT210-0001	2D21, 5727	
QS150/40	0D3, 0D3A		WT210-0003	884	
QS150C1, QS150C2	0A2, 0A2WA, 6073, 6073/OA2, 6626/OA2WA		WT210-0004	2050	2050A
QS150C3	0D3, 0D3A		WT210-0006		6H6
QS1205	0A3, 0A3A		WT210-0007		6L6, 6L6GC
QS1206	0C3, 0C3A		WT210-0011	0C3, 0C3A	
QS1207	0A2, 0A2WA, 6073, 6073/OA2, 6626/OA2WA		WT210-0018	0D3, 0D3A	
QS1208	OB2, OB2WA, 6074, 6074/OB2		WT210-0019	83	
QS1210	0A2WA, 6626/OA2WA	OA2, 6073, 6073/OA2	WT210-0021		6X5GT
			WT210-0028		3Q5GT

Type to be Replaced	RCA Replacement		Type to be Replaced	RCA Replacement	
	Direct	Similar		Direct	Similar
WT210-0029		6C5	WT308		6X5GT
WT210-0040	6X4W	6X4	WT389		3Q5GT
WT210-0042		5Y3GT	WT390		6C5
WT210-0048		5U4GB	WT606	2D21, 5727	
WT210-0060		0Z4A/OZ4	WTT100	6X4W	6X4
WT210-0077	5727	2D21	WTT102		5Y3GT
WT210-0081		6SJ7, 5697	WTT103		6H6
WT210-0082		6V6, 6V6GTA	WTT108C1	0B2, 0B2WA, 6074, 6074/0B2	
WT210-0084		6N7, 6N7GT	WTT114	0Z4A/OZ4	
WT210-0085		50B5	WTT122	5693	6SJ7
WT210-0087		6K8	WTT123		6V6, 6V6GTA
WT210-0088		6J5, 6J5GT	WTT123		6AT6
WT210-0090		6C6	WTT125		6N7, 6N7GT
WT210-0091	0A4G		WTT126		50B5
WT210-0108	6AS7G, 6080, 6080WA	6AS7GA	WTT127	833A	
WT210-0148		6X5GT	WTT128		6K8
WT210-3000	2D21, 5727, 5727/2D21W		WTT129		6J5, 6J6GT
WT245	884		WTT131		6C6
WT246	2050, 2050A		WTT132	0A4G	
WT261, WT261A		6H6	WTT135		5U4GB
WT269	0C3, 0C3A		X77		5750
WT294	0D3, 0D3A		X727		5750
WT301, WT301A	83		Z900T	5823	
			Z3000T	0A4G	

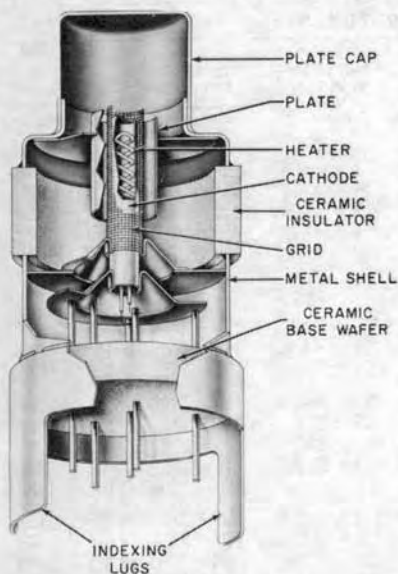

← **Double-ended Type**

Single-ended Type →

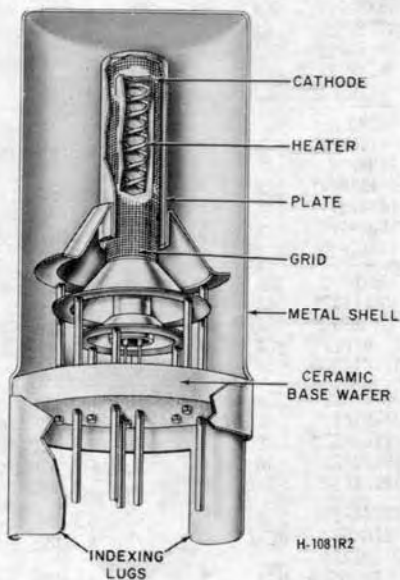

H-1081R2

Cutaway Views of Typical Nuvistor Triodes

PICTURE TUBE CHARACTERISTICS CHART

Color Picture Tubes

Type No.	Envelope Code ^o	Safety Feature [★]	Nom. Deflection Angle Degrees	Heater Volts/mA	Max. Anode Voltage kV [†]	Range of Focus Voltage in Volts or % of Anode Voltage	Range of G2 Voltage at G1 = -150 V Volts	Screen Diag. Inches	Terminal Diagram ^Δ
14VAHP22 ^h	SGA	H	90	6.3/900	22.5	-75V — +400V ^g	150 — 390 ⁱ	13.557	14BH
14VALP22 ^h	SGA	M	90	6.3/900	22.5	-75V — +400V ^g	150 — 390 ⁱ	13.557	14BH
15AEP22 ^c	SGA	M	90	6.3/900	22.5	-75V — +400V ^g	150 — 390 ⁱ	13.557	14BH
15LP22 ^c	SGAT	D	90	6.3/900	22.5	-75V — +400V ^g	150 — 390 ⁱ	13.557	14BH
15NP22 ^c	SGA	H	90	6.3/900	22.5	-75V — +400V ^g	150 — 390 ⁱ	13.557	14BH
15VADTC01 ^{hp}	SGA	H	90	6.3/900	27.5	16.8 — 20.0	425 — 820	15.051	13D
15VAETC01 ^{hmp}	SGA	H	90	6.3/900	d27.5	16.8 — 20.0	425 — 820	15.051	13D
16VACP22 ^b	SGA	H	90	6.3/900	22.5	-75V — +400V ^g	165 — 420 ⁱ	16.191	14BH
17EZP22 ^c	SGA	H	90	6.3/900	22.5	-75V — +400V ^g	150 — 390 ⁱ	16.191	14BH
17VACP22 ^h	SGA	F	90	6.3/900	22.5	-75V — +400V ^g	150 — 385 ⁱ	17.018	14BH
17VADP22 ^{hm}	SGA	F	90	6.3/900	22.5	-75V — +400V ^g	150 — 385 ⁱ	17.018	14BH
17VARP22 ^{hm}	SGA	F	90	6.3/900	27.5	16.8 — 20.0	255 — 655	17.018	14BE
17VAYTC01 ^{hmp}	SGA	F	90	6.3/900	d27.5	16.8 — 20.0	425 — 820	17.018	13D
18VAHP22 ^b	SGAT	D	90	6.3/900	27.5	16.8 — 20.0	285 — 685	18.075	14BE
18VAZP22 ^h	SGA	F	90	6.3/900	22.5	-75V — +400V ^g	150 — 390 ⁱ	18.075	14BH
18VBDP22 ^b	SGA	F	90	6.3/900	22.5	-75V — +400V ^g	150 — 390 ⁱ	18.075	14BH
18VBGP22 ^h	SGAT	D	90	6.3/900	22.5	-75V — +400V ^g	150 — 390 ⁱ	18.075	14BH
18VBJP22 ^h	SGA	K	90	6.3/900	22.5	-75V — +400V ^g	285 — 685	18.075	14BH
18VBKP22 ^{hm}	SGA	F	90	6.3/900	27.5	16.8 — 20.0	285 — 685	18.075	14BE
19GVP22/ 19EXP22 ^c	SGA	A	90	6.3/900	27.5	16.8 — 20.0	285 — 685	18.075	14BE
19GWP22/ 19EYP22 ^c	SGAT	D	90	6.3/900	27.5	16.8 — 20.0	285 — 685	18.075	14BE
19HCP22/ 19HKP22 ^c	SGA	F	90	6.3/900	27.5	16.8 — 20.0	285 — 685	18.075	14BE
19HNP22 ^c	SGA	F	90	6.3/900	22.5	-75V — +400V ^g	150 — 390 ⁱ	18.075	14BH
19JWP22 ^c	SGAT	D	90	6.3/900	22.5	-75V — +400V ^g	150 — 390 ⁱ	18.075	14BH
19VABP22 ^h	RGAT	D	70	6.3/1800	27.5	16.8 — 20.0	310 — 690	19.250	14AU
19VANP22 ^h	SGA	F	90	6.3/900	22.5	-75V — +400V ^g	150 — 390 ⁱ	18.897	14BH
19VBLP22 ^h	SGA	F	110	6.3/900	27.5	16.8 — 20.0	265 — 665	18.897	13C
19VBQP22 ^{hm}	SGA	F	90	6.3/900	22.5	-75V — +400V ^g	150 — 375 ⁱ	18.897	14BH
19VBRP22 ^{c-m}	SGA	F	90	6.3/900	27.5	16.8 — 20.0	285 — 685	18.897	14BE
19VCTP22 ^{c-m}	SGA	F	90	6.3/900	27.5	16.8 — 20.0	260 — 660	18.897	14BE
19VDSP22 ^{hm}	SGA	F	90	6.3/900	d27.5	16.8 — 20.0	260 — 660	18.897	14BE
19VDTP22 ^h	SGA	F	90	6.3/900	d27.5	16.8 — 20.0	260 — 660	18.897	14BE
19VEDP22 ^{hm}	SGA	F	90	6.3/900	d32.0	16.8 — 20.0	250 — 645	18.897	14BE
19VEUP22 ^h	SGA	F	90	6.3/900	d32.0	16.8 — 20.0	250 — 645	18.897	14BE
20VAGP22 ^h	SGAT	D	90	6.3/900	27.5	16.8 — 20.0	285 — 685	20.233	14BE
20VAHP22 ^h	SGA	F	90	6.3/900	22.5	-75V — +400V ^g	150 — 390 ⁱ	20.233	14BH
21FJP22 ^c	RGAT	D	70	6.3/1800	27.5	16.8 — 20.0	310 — 690	19.250	14AU
21GUP22/ 21FBP22A ^c	RGA	A	70	6.3/1900	27.5	16.8 — 20.0	310 — 690	19.250	14AU
21GVP22/ 21FJP22A ^c	RGAT	D	70	6.3/1900	27.5	16.8 — 20.0	310 — 690	19.250	14AU
21VAKP22 ^{bm}	SGAT	D	90	6.3/900	27.5	16.8 — 20.0	285 — 685	20.871	14BE
21VAMP22 ^c	SGAT	D	90	6.3/900	27.5	16.8 — 20.0	285 — 685	20.871	14BE
21VBEP22 ^h	SGA	F	90	6.3/900	d32.0	16.8 — 20.0	250 — 645	20.871	14BE
22JP22 ^c	SGAT	D	90	6.3/900	27.5	16.8 — 20.0	285 — 685	20.233	14BE
22KP22 ^c	SGA	A	90	6.3/900	27.5	16.8 — 20.0	285 — 685	20.233	14BE
22UP22 ^c	SGA	F	90	6.3/900	27.5	16.8 — 20.0	285 — 685	20.233	14BE

Color Picture Tubes (Cont.)

Type No.	Envelope Code ●	Safety Feature ★	Nom. Deflection Angle Degrees	Heater Volts/mA	Max. Anode Voltage kV*	Range of Focus Volts or % of Anode Voltage	Range of at E1 = -150 V Volts	Screen Diag. Inches	Terminal Diagram ▲
23VALP22 ^{b,m}	SGAT	D	90	6.3/900	27.5	16.8—20.0	260—660	22.995	14BE
23VANP22 ^b	SGAT	D	90	6.3/900	27.5	16.8—20.0	260—660	22.995	14BE
23VAQP22 ^c	SGA	F	90	6.3/900	27.5	16.8—20.0	260—660	22.995	14BE
25BCP22 ^{c,m}	SGAT	D	90	6.3/900	27.5	16.8—20.0	260—660	22.995	14BE
25VABP22 ^{c,m}	SGAT	D	90	6.3/900	27.5	16.8—20.0	260—660	24.658	14BE
25VAEP22 ^c	SGAT	D	90	6.3/900	27.5	16.8—20.0	260—660	24.658	14BE
25VAMP22 ^{c,m}	SGAT	D	90	6.3/900	27.5	16.8—20.0	250—650	24.658	14BE
25VBEP22 ^{h,m}	SGA	K	90	6.3/900	27.5	16.8—20.0	285—685	24.658	14BE
25VCKP22 ^{c,m}	SGAT	D	90	6.3/900	d32.0	16.8—20.0	250—645	24.658	14BE
25VCZP22 ^{h,m}	SGA	F	90	6.3/900	d32.0	16.8—20.0	295—680	24.658	14BE
25VDP22 ^{h,m}	SGA	D	90	6.3/900	d32.0	16.8—20.0	250—645	24.658	14BE
25XP22/ 25AP22 ^c	SGAT	D	90	6.3/900	27.5	16.8—20.0	285—685	22.995	14BE
25YP22/ 25BP22 ^{a,c}	SGA	A	90	6.3/900	27.5	16.8—20.0	285—685	22.995	14BE

Color Test Picture Tube

1830P22	SGAT	D	90	6.3/900	27.5	16.8—20.0	285—685	18.075	14BE
1895P22	SGAT	D	90	6.3/900	d32.0	16.8—20.0	260—660	18.075	14BE

Silverama^a Types for Black-and-White TV

Type No.	Envelope Code ●	Safety Feature ★	Nom. Deflection Angle Degrees	Heater Volts/mA	Focusing Method ■	Design Max. Anode Voltage kV	Typical G2 Voltage Volts	Screen Diag. Inches	Max. Overall Length Inches	Terminal Diagram ▲
5VABP4	SGA	A	70	12.0/79	E	15.0	115	5.036	7.550	7GR
80P4‡	SG	A	90	6.3/600	E	9.0	200	7.750	10.750	12AB
9ACP4	SGA	F	85	6.3/450	E	15.0	100	9.024	8.700	7GR
9VABP4	SGA	F	85	6.3/450	E	15.0	140	9.024	8.700	7GR
9VAJP4	SGA	H	90	11.0/140	E	15.0	90	9.000	8.700	7GR
9WP4	SGA	G	90	12.0/75	E	12.0	100	8.270	8.270	7GR
10ATP4	SGA	F	85	6.3/300	E	15.0	140	9.024	8.700	7GR
10AVP4	SGA	F	85	12.0/79	E	15.0	90	9.024	8.700	7GR
11CP4	SGA	A	110	6.3/450	E	15.0	400	10.125	9.188	8HR
11GP4	SGA	C	110	6.3/450	E	15.0	135	10.188	9.188	8HR
12BNP4A	SGA	J	110	6.3/450	E	16.0	250	11.625	9.598	8HR
12DEP4	SGA	F	110	6.3/450	E	15.0	100	11.625	9.690	7GR
12DFP4	SGA	H	110	6.3/450	E	15.0	200	11.620	9.060	7GR
12DKP4	SGA	F	110	6.3/450	E	16.0	140	11.625	9.374	7GR
12DSP4	SGA	H	110	6.3/300	E	15.0	140	11.625	9.274	7GR
12VAGP4	SGA	G	110	6.3/300	E	14.0	200	11.500	9.530	7GR
12VAQP4	SGA	G	110	4.2/450	E	15.0	140	11.500	9.530	7GR
12VAWP4	SGA	J	110	6.3/450	E	15.0	130	11.500	9.53	7GR
12VAXP4	SGA	J	110	11.0/82	E	14.0	150	11.500	9.530	7GR
12VBNP4	SGA	H	90	11.0/140	E	15.0	90	11.500	11.125	7GR

▲ Terminal diagrams for RCA picture tubes are shown on pages 672 and 673. For SAFETY PRECAUTIONS and NOTES refer to page 670.

‡ Requires ION trap.

Silverama^a Types for Black-and-White TV (Cont.)

Type No.	Envelope Code ●	Safety Feature ★	Nom. Deflection Angle Degrees	Heater Volts/mA ^b	Focusing Method ■	Design Max. Anode Voltage kV	Typical G2 Voltage Volts	Screen Diag. Inches	Max. Overall Length Inches	Terminal Diagram ▲
15VACP4	SGA	H	114	6.3/450	E	20.0	30	14.875	10.811	8HR
16CMP4A	SGA	G	114	6.3/450	E	18.0	300	14.875	10.811	8HR
16RP4B	SGA	A	70	6.3/600	M	17.5	300	14.875	19.125	12N
16VAGP4	SGA	H	114	6.3/450	E	20.0	30	16.250	11.445	8HR
16VBYP4	SGA	F	114	11.0/140	E	22.0	130	16.250	11.450	8HR
17BP4D	SGA	A	70	6.3/600	M	17.5	300	15.562	19.562	12N
17CFP4	SGA	A	90	6.3/600	E	17.5	300	15.750	14.375	12L
17DQP4	SGA	A	110	6.3/450	E	17.5	50	15.750	12.375	7FA
17DRP4	SGA	A	110	2.68/450	E	17.5	300	15.750	11.000	8JK
17LP4B	SGCA	A	70	6.3/600	E	17.5	300	15.562	19.562	12L
17QP4B	SGCA	A	70	6.3/600	M	20.0	300	15.562	19.562	12N
18VAUP4	SGA	F	114	6.3/450	E	23.5	30	17.562	11.875	8HR
19ABP4	SGA	A	114	2.68/450	E	20.0	300	17.562	11.125	8JK
19AFP4	SGA	B	114	6.3/600	E	20.0	300	17.625	11.938	8HR
19AJP4	SGA	A	114	6.3/450	E	20.0	50	17.562	11.625	7FA
19AVP4	SGA	A	114	6.3/600	E	23.0	400	17.562	11.625	8HR
19AYP4	SGA	A	114	6.3/450	E	23.0	400	17.562	11.625	8HR
19BDP4	SGA	A	92	6.3/600	E	19.8	50	17.562	15.625	12L
19CHP4	SGA	A	114	6.3/600	E	20.0	50	17.562	11.875	8HR
19CMP4	SGA	A	114	6.3/450	E	20.0	30	17.562	11.875	8HR
19CVP4	SGA	B	114	6.3/450	E	23.0	50	17.625	11.938	8HR
19CXP4	SGA	A	114	6.3/600	E	20.0	45	17.562	11.875	7FA
19DBP4	SGA	D	114	6.3/450	E	19.8	40	17.562	12.125	7FA
19DQP4	SGA	G	114	6.3/450	E	23.0	300	17.562	11.875	8HR
19DRP4	SGA	G	114	6.3/600	E	23.0	300	17.562	11.875	8HR
19DSP4	SGA	G	114	6.3/600	E	20.0	50	17.562	11.875	8HR
19DUP4	SGA	F	114	6.3/450	E	22.0	50	17.562	11.969	8HR
19EBP4	SGA	C	114	6.3/600	E	23.0	400	17.562	11.875	8HR
19EGP4	SGA	C	114	6.3/450	E	21.0	50	17.562	11.875	8HR
19ECP4	SGA	C	114	6.3/450	E	19.8	45	17.562	11.875	7FA
19FLP4	SGA	G	114	6.3/450	E	23.0	300	17.562	11.625	8HR
19GAP4	SGA	C	114	6.3/450	E	19.8	400	17.562	11.875	8HR
19GEP4A	SGA	L	114	6.3/450	E	23.0	300	17.562	11.875	8HR
19VAHP4	SGA	H	114	6.3/450	E	23.0	30	18.625	12.519	8HR
19VAJP4	SGA	H	114	9.45/300	E	23.0	30	18.625	12.519	8HR
19VALP4	SGA	C	114	6.3/450	E	23.0	300	18.625	12.519	8HR
19VFEP4	SGA	F	114	11.0/140	E	23.0	130	18.625	12.644	8HR
20RP4	SGA	F	114	6.3/450	E	22.0	50	18.625	12.613	8HR
20VAQP4	SGA	F	114	6.3/450	E	23.5	30	19.625	12.937	8HR
21AMP4B	SGA	A	90	6.3/600	M	20.0	300	20.250	20.375	12N
21AVP4C	SGA	A	72	6.3/600	E	22.0	300	20.250	23.406	12L
21AWP4A	SGA	A	72	6.3/600	M	20.0	400	20.250	23.406	12N
21CBP4A	SGA	A	90	6.3/600	E	22.0	300	20.250	18.375	12L
21CQP4	SGA	A	110	6.3/600	E	20.0	300	20.250	14.812	7FA
21DLP4	SGA	A	90	6.3/600	E	22.0	300	20.250	17.375	12L
21DSP4	SGA	A	90	6.3/600	E	22.0	50	20.250	18.375	12L
21EMP4/ 21EQP4	SGA	A	110	6.3/600	E	20.0	500	20.250	13.440	8HR
21EP4C	SGCA	A	70	6.3/600	M	20.0	300	20.000	23.406	12N
21FDP4	SGA	A	110	6.3/600	E	20.0	300	20.250	13.375	8KW
21FP4B	SGCA	A	70	6.3/600	E	20.0	300	20.000	23.406	12L

Silverama^a Types for Black-and-White TV (Cont.)

Type No.	Envelope Code ●	Safety Feature ★	Nom. Deflection Angle Degrees	Heater Volts/MA	Focusing Method ■	Design Max. Anode Voltage kV	Typical GZ Voltage Volts	Screen Diag. Inches	Max. Overall Length Inches	Terminal Diagram ▲
21FYP4	SGA	G	114	6.3/450	E	23.0	400	19.625	12.937	8HR
21GAP4A	SGA	G	114	6.3/450	E	23.5	30	19.625	12.937	8HR
21WP4B	SGA	A	70	6.3/600	M	20.0	300	19.250	22.812	12N
21XP4B	SGA	A	70	6.3/600	E	20.0	300	19.250	22.812	12L
21YP4B	SGA	A	70	6.3/600	E	20.0	300	20.000	23.406	12L
21ZP4C	SGA	A	70	6.3/600	M	20.0	300	20.000	23.406	12N
22VABP4	SGA	F	110	6.3/450	E	23.5	30	22.312	14.406	8HR
22VACP4	SGAT	D	110	6.3/450	E	23.0	30	22.312	14.594	8HR
22VADP4	SGA	C	92	6.3/450	E	25.0	400	22.312	18.375	12L
22VAEP4	SGA	K	110	6.3/450	E	23.0	300	22.312	15.156	8HR
23ANP4/ 23ASP4	SGA	A	92	6.3/600	E	22.0	400	22.312	17.875	12L
23ARP4	SGA	A	110	6.3/600	E	22.0	400	22.312	15.156	8HR
23BGP4	SGA	B	110	6.3/600	E	22.0	50	22.312	15.562	8HR
23BJP4	SGA	A	92	6.3/600	E	25.0	50	22.312	18.500	12L
23BKP4	SGA	B	92	6.3/600	E	25.0	50	22.312	18.875	12L
23BQP4	SGA	B	110	6.3/450	E	23.0	300	22.312	15.562	8HR
23CGP4	SGA	A	92	6.3/450	E	22.0	500	22.312	18.375	12L
23CP4	SGA	B	110	6.3/600	E	22.0	400	22.312	15.562	8HR
23CP4A	SGA	B	110	6.3/600	E	23.5	300	22.312	15.562	8HR
23CQP4	SGA	A	114	6.3/450	E	23.5	500	22.312	14.000	8HR
23DAP4	SGA	A	94	6.3/600	E	23.0	50	22.312	17.391	8HR
23DBP4	SGA	A	110	6.3/600	E	22.0	50	22.312	15.156	8HR
23EKP4	SGA	G	92	6.3/450	E	25.0	400	22.312	18.375	12L
23ENP4	SGA	G	92	6.3/600	E	25.0	50	22.312	18.500	12L
23EP4	SGA	B	110	6.3/600	E	22.0	50	22.312	15.562	8KP
23ETP4	SGA	G	110	6.3/600	E	23.0	300	22.312	15.156	8HR
23EWP4A	SGA	F	114	6.3/450	E	22.0	400	22.312	14.812	8HR
23EYP4	SGA	C	92	6.3/600	E	25.0	35	22.312	18.500	12L
23EZP4	SGA	K	94	6.3/450	E	23.5	50	22.312	17.390	8HR
23FP4A	SGA	A	114	6.3/600	E	23.5	500	22.312	14.062	8HR
23FRP4	SGA	C	110	6.3/450	E	23.0	50	22.312	14.500	8HR
23FSP4	SGA	C	110	6.3/600	E	23.0	400	22.312	15.125	8HR
23GWP4	SGA	F	110	6.3/450	E	22.0	50	22.312	14.781	8HR
23HFP4A	SGA	G	110	6.3/450	E	23.0	300	22.312	15.156	8HR
23HWP4A	SGA	L	110	6.3/450	E	22.0	50	22.312	15.156	8HR
23JEP4	SGA	K	110	6.3/450	E	23.0	300	22.312	15.156	8HR
23JP4	SGA	B	110	6.3/450	E	22.0	50	22.312	15.875	7FA
23NP4	SGA	A	114	6.3/600	E	22.0	50	22.312	14.812	8HR
23YP4	SGA	B	92	6.3/600	E	22.0	300	22.312	18.750	12L
24AEP4	SGA	A	90	6.3/600	E	22.0	300	22.812	19.500	12L
24ANP4	SGA	A	110	6.3/600	E	22.0	400	22.812	16.188	8HR
24AUP4	SGA	A	90	6.3/600	E	22.0	300	22.812	18.500	12L
24CP4B	SGA	A	90	6.3/600	M	22.0	300	22.812	21.500	12N

Black-and-White Test Picture Tube

8XP4	SGA	A	90	6.3/600	A	22.0	400	7.750	11.750	12S
------	-----	---	----	---------	---	------	-----	-------	--------	-----

▲ Terminal diagrams for RCA picture tubes are shown on pages 672 and 673. For SAFETY PRECAUTIONS and NOTES refer to page 670.

SAFETY PRECAUTIONS

In servicing a television receiver that requires a replacement picture tube, a tube with the same type number or an RCA recommended replacement tube type

should be used to assure the same or improved integral x-radiation shielding and implosion protection.

Note: For additional Safety Precautions, refer to page 93.

Notes for Picture Tube Characteristics Chart

● **Envelope Code** (All types have spherical faceplate except where noted)

- R Round
- S Rectangular
- G Glass
- C Cylindrical faceplate
- A Aluminized
- T Treated faceplate

★ Safety Feature

- A Conventional Tube — Requires Safety Window in Receiver
- B Integral Moulded-Glass Safety Panel (Bi-Panel*)
- C Filled Rim (Shelbond†)
- D Integral Safety Panel (Laminated)
- F Tension Band Over Formed Rim Bands (Kimcode †)
- G Welded Tension Band Over Formed Rim Bands (Pan-O-Ply*)
- H Tension Band Over Tape (T-Band)
- J Welded Tension Band Over Tape (T-Band)
- K Tension Band Over Formed Rim Bands With Mounting Lugs (Kimcode/Lugs)

- L Welded Tension Band Over Formed Rim Bands With Mounting Lugs (Pan-O-Ply/Lugs)
- M Tension Band With Mounting Lugs Over Tape (T-Band Lugs)

■ Focusing Method

- A Automatic focus
- E Electrostatic focus
- M Magnetic focus

Footnotes

- a. All Materials and parts used in the manufacture of RCA Silverama Picture Tubes are new except for the envelope which, prior to reuse, was carefully inspected to meet the standards of the original new envelope.
- b. Both Colorama and Hi-Lite versions are available.
- c. Only Colorama versions (prefix C— or CA—) are available. RCA Colorama Picture Tubes contain used materials which, prior to reuse, are carefully in-

spected to meet RCA's high quality standards.

- d. Absolute-Maximum value.
- g. This type has an einzel lens focus system. Values shown are in volts which do not vary with anode voltage.
- h. Only Hi-Lite Versions (prefix H—) are available. RCA Hi-Lite Color Picture Tubes contain all New Parts and Materials.
- j. At Grid-No.1 voltage of —100 volts.
- k. At Grid-No.1 voltage of —50 volts.
- m. MATRIX Color Picture Tube.
- p. Precision In-Line Color Picture Tube.

* Trademark of RCA, Lancaster, Pa., 17604.

† Trademark of Corning Glass Works, Corning, N.Y. 14830

‡ Trademark of Owens-Illinois, Inc., Columbus, Oh. 58727

◆ Design-Maximum value unless otherwise noted.

Key to Color Picture Tube Type Designation System

Old-Designation Series (Rounded-off Tube Glass Diagonal in Inches)	Equivalent New Designation Series (Rounded-off Min. Screen Diagonal in Inches)	Comparable Japanese Designation Series (Rounded-off Tube Glass Diagonal in mm)	Other Designation Series Replaced by this Series
11	10 V	270	—
12	—	—	—
13	12 V	320	—
14	—	350	—
15	14 V	370	—
16	—	400	—
—	15 V	420	—
17	16 V	440	—
—	17 V	470	—
19	18 V	490	—
—	19 V	510	—
21	—	—	—
21 (Round)	19 V	—	—
22	20 V	550	21
22	21 V	—	—
23	—	—	—
25	23 V	—	23
26	25 V	—	—

Key to Black-and-White Picture Tube Type Designation System

Old-Designation Series (Rounded-off Tube Glass Diagonal in Inches)	Equivalent New Designation Series (Rounded-off Min. Screen Diagonal in Inches)	Comparable Japanese Designation Series (Rounded-off Tube Glass Diagonal in mm)
9	—	230
10	—	240
11	10 V	280
12	12 V	310
13	—	—
—	13 V	340
14	—	—
15	—	—
16	15 V	400
17	16 V	440
19	18 V	470
20	19 V	500
21	20 V	520
22	21 V	—
23	22 V	590
24	—	—
25	—	—

Terminal Diagrams for Picture Tubes

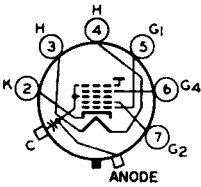
**7FA**

Anode = $G_3 + G_4 + CL$
Focusing Electrode = G_4

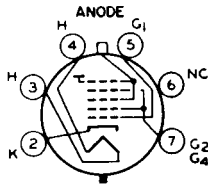
**7FG**

Anode = $G_3 + G_5 + CL$
Automatic Focusing

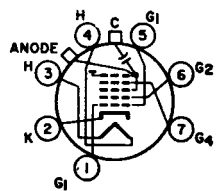
**7GR**

Anode = $G_3 + G_5 + CL$
Focusing Electrode = G_4

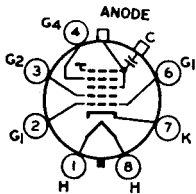
**8HR**

Anode = $G_3 + G_5 + CL$
Focusing Electrode = G_4

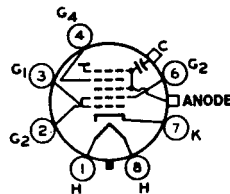
**8JK**

Anode = $G_3 + G_5 + CL$
Focusing Electrode = G_4

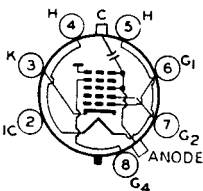
**8KP**

Anode = $G_3 + G_5 + CL$
Focusing Electrode = G_4

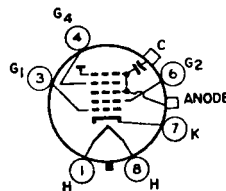
**8KW**

Anode = $G_3 + G_5 + CL$
Focusing Electrode = G_4

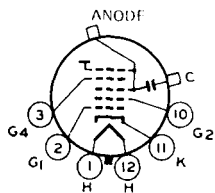

12AB

Anode = $G_3 + G_3 + CL$
 Focusing Electrode = G_4

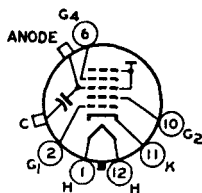

12L

Anode = $G_3 + G_3 + CL$
 Focusing Electrode = G_4

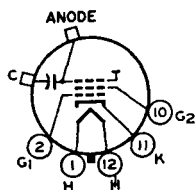

12N

Anode = $G_3 + CL$

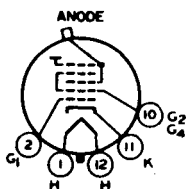

12S

Anode = $G_3 + G_3 + CL$
 Automatic Focusing

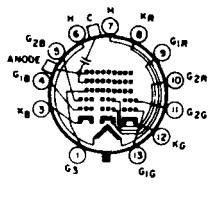

13C

Anode = $G_4 + CL$
 Focusing Electrode = G_3

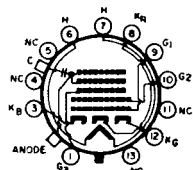

13D

Anode = $G_2 + CL$
 Focusing Electrode = G_3

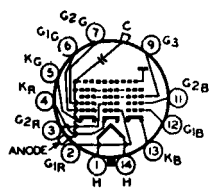

14AU

Anode = $G_4 + G_3 + CL$
 Focusing Electrode = G_3

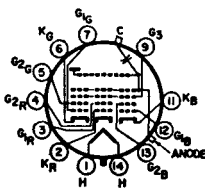

14BE

Anode = $G_4 + G_3 + CL$
 Focusing Electrode = G_3

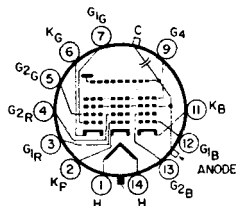

14BH

Anode = $G_3 + G_3 + CL$
 Focusing Electrode = G_4

Circuits

THE circuits included in this Manual illustrate some of the more important applications of RCA receiving tubes; they are not necessarily examples of commercial practice. These circuits have been conservatively designed and are capable of excellent performance. The brief description provided with each circuit explains the functional relationships of the various stages and points out intended applications, major performance characteristics, and significant design features of the over-all circuit. Detailed descriptive information on individual circuit stages (for example, amplifiers, detectors, or oscillators) is given in the section on **Electron-Tube Applications** earlier in this Manual, as well as in many textbooks on electron-tube circuits.

Electrical specifications are given for circuit components to assist those interested in home construction. Layouts and mechanical details are omitted because they vary widely with the requirements of individual set builders and with the sizes and shapes of the components employed.

Circuits designed for operation from both ac and dc voltage supplies should be installed in non-metallic cabinets or properly insulated from metallic cabinets. Potentiometer shafts and switches should make use of insulated (plastic) knobs. In practical use, no metallic part of an "ac/dc" chassis should be exposed to touch, accidental or otherwise. When such circuits are tested outside of their cabinets, a line isolation transformer such as the RCA WP-25A Isotap should be used.

Performance of these circuits depends as much on the quality of the components selected and the care employed in layout and construction as on the circuits themselves. Good signal reproduction from receivers and amplifiers requires the use of good-quality speakers, transformers, chokes, and input sources (microphones, phonograph pickups, etc.).

Coils for the receiver circuits may be purchased at local parts dealers by specifying the characteristics required: for rf coils, the circuit position (antenna or interstage), tuning range desired, and tuning capacitances employed; for if coils or transformers, the intermediate frequency, circuit position (1st if, 2nd if, etc.), and, in some cases, the associated tube types; for oscillator coils, the receiver tuning range, the intermediate frequency, the type of converter tube, and the type of winding used (tapped or transformer-coupled).

The voltage ratings specified for capacitors are the minimum dc working voltages required. Paper, mica, or ceramic capacitors having higher voltage ratings than those specified may be used except insofar as the physical sizes of such capacitors may affect equipment layout. However, if electrolytic capacitors having substantially higher voltage ratings than those specified are used, they may not "form" completely at the operating voltage, with the result that the effective capacitances of such units may be below their rated value. The wattage ratings specified for resistors assume methods of construction that provide adequate ventilation; com-

pact installations having poor ventilation may require resistors of higher wattage ratings.

Circuits which work at very high frequencies or which are required to handle very wide bandwidths demand more than ordinary skill and experience in construction. Placement of component parts is quite critical and may require considerable experimentation. All rf leads to components including bypass capacitors must be kept short and must be prop-

erly dressed to minimize undesirable coupling and capacitance effects. Correct circuit alignment and oscillator tracking may require the use of a cathode-ray oscilloscope, a high-impedance vacuum-tube voltmeter, and a signal generator capable of supplying a properly modulated signal at the appropriate frequencies. Unless the builder has had considerable experience with broad-band, high-frequency circuits, he should not undertake the construction of such circuits.

LIST OF CIRCUITS

	Page
29-1 AC/DC Superheterodyne Radio Receiver	677
29-2 AM/FM Superheterodyne Radio Receiver	678
29-3 FM Tuner	682
29-4 Three-Stage IF Amplifier/Limiter and Detector	684
29-5 FM Stereo Multiplex Adapter	686
29-6 Preamplifier for Amateur Receiver (21-, 30-, and 50-MHz Amateur Bands and 27-MHz Citizens Band)	688
29-7 Code-Practice Oscillator	690
29-8 Intercommunication Set (With Master Unit and Two or More Remote Units)	691
29-9 High-Fidelity Audio Amplifier (Class AB _i ; Power Output, 15 Watts)	692
29-10 High-Fidelity Audio Amplifier (Class AB _i ; Power Output, 30 Watts)	694
29-11 High-Fidelity Audio Amplifier (Class AB _i ; Power Output, 50 Watts)	696
29-12 Two-Channel Stereophonic Amplifier (Power Output, 1 Watt Each Channel)	698
29-13 Microphone and Phonograph Amplifier (Power Output, 8 Watts)	699
29-14 Two-Channel Audio Mixer	700
29-15 Phonograph Amplifier (Power Output, 1 Watt)	701
29-16 Preamplifier for Magnetic Phonograph Pickup (With RIAA Equalization)	702
29-17 High-Fidelity Preamplifier for Tape-Head Pickup (With NARTB Equalization)	703
29-18 Preamplifier for Ceramic Phonograph Pickup (Cathode-Follower Output)	704
29-19 Low-Distortion Preamplifier (For Low-Output, High-Impedance Microphones)	705

29-20	Bass and Treble Tone-Control Amplifier	706
29-21	Electronic Volt-Ohm Meter	707
29-22	Series-Type Stabilized Voltage Supply	710
29-23	All-Purpose Power Supplies	711
29-24	VHF Tuner (For Black-and-White TV Receiver)	713
29-25	Video IF Amplifiers and Sound-Channel Circuits (For Black-and-White TV Receiver)	716
29-26	Video, AGC, and Sync Amplifiers, (For Black-and-White TV Receiver)	718
29-27	Vertical and Horizontal Deflection Circuits and High-Voltage Rectifier (For Black-and-White TV Receiver)	720
29-28	Low-Voltage and Heater Supply (For Black-and-White TV Receiver)	724
29-29	Low-Voltage Power Supply, Degaussing Circuit, and Heater Connections (For Color TV Receiver)	726
29-30	VHF Tuner (For Color TV Receiver)	728
29-31	Video- and Sound-Channel Circuits (For Color TV Receiver)	731
29-32	Sync, AGC, and Vertical-Deflection Circuits (For Color TV Receiver)	735
29-33	Horizontal-Deflection Circuit and High-Voltage Power Supply (For Color TV Receiver)	737
29-34	Chroma Circuits (For Color TV Receiver)	741
29-35	Picture Tube and Associated Circuits (For Color TV Receiver)	745

MANUFACTURERS OF SPECIAL COMPONENTS AND MATERIALS REFERRED TO IN PARTS LIST

Allen-Bradley Co.
1201 S. 2nd Street
Milwaukee, Wis. 53204

Alpha Wire Corp.
711 Lidgerwood Avenue
Elizabeth, N. J. 07202

Arco Electronics, Inc.
Community Drive
Great Neck, N. Y. 11021

Freed Transformer Company, Inc.
1795 Weirfield Street
Brooklyn, N. Y. 11227

Knight Products
Allied Radio Corp.
100 N. Western Avenue
Chicago, Ill. 60612

J. W. Miller Co.
5917 S. Main Street
Los Angeles, Calif. 90003

Moldite Electronics Corp.
250 South Street
Newark, N. J. 07114

Ohmite Manufacturing Co.
3635 W. Howard Street
Skokie, Ill. 60076

Stancor Electronics, Inc.
3501 W. Addison Street
Chicago, Ill. 60618

Thordarson-Meissner, Inc.
Electronic Center
7th and Belmont
Mt. Carmel, Ill. 62863

Triad Distributor Div.
Litton Industries
305 N. Briant Street
Huntington, Ind. 46750

United Transformer Corp.
Div. Thompson-Ramo-Wooldridge,
150 Varick Street
New York, N. Y. 10013

Note: Components and materials identified by RCA stock numbers may be obtained through authorized RCA distributors.

29-1 AC/DC SUPERHETERODYNE RADIO RECEIVER

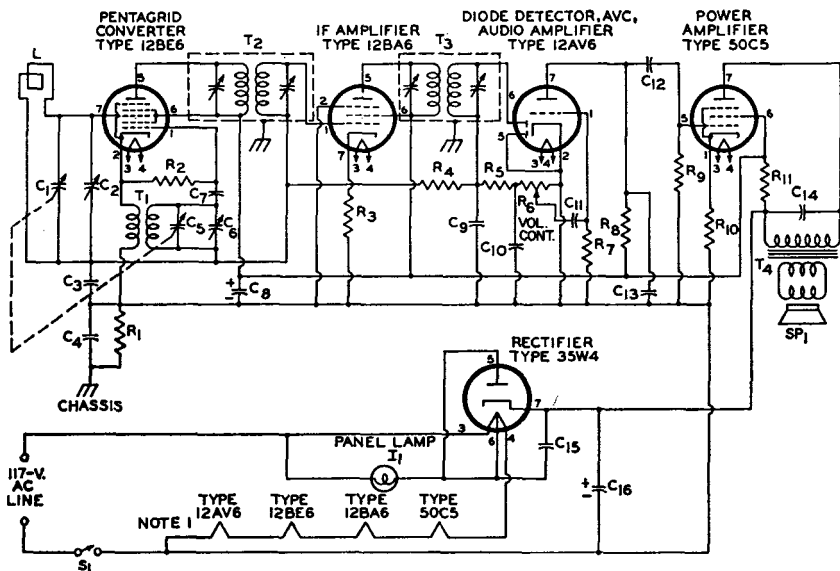

Parts List

C₁, C₅=Ganged tuning capacitors; C₂, 10-365 pF, C₈, 7-115 pF

C₃=Trimmer capacitor, 4-30 pF

C₃=0.05 μF, paper, 50 V

C₄=0.1 μF, paper, 400 V

C₆=Trimmer capacitor, 2-17 pF

C₇=56 pF, ceramic

C₈=80 μF, electrolytic, 150 V

C₉, C₁₀=150 pF, ceramic

C₁₁, C₁₄=0.02 μF, paper, 400 V

C₁₂=0.002 μF, paper, 400 V

C₁₃=380 pF, mica

C₁₅=0.05 μF, paper, 400 V

C₁₆=50 μF, electrolytic, 150 V

I₁=Panel lamp, No. 40 or 47
L=Loop antenna or ferrite-rod antenna, 540-1600 kHz (with specified values of capacitance for C₁ and C₂)

R₁=0.22 megohm, 0.5 watt

R₂=33000 ohms, 0.5 watt

R₃=100 ohms, 0.5 watt

R₄=3.3 megohms, 0.5 watt

R₅=47000 ohms, 0.5 watt

R₆=Volume control, potentiometer, 0.5 megohm

R₇=4.7 megohms, 0.5 watt

R₈, R₉=0.47 megohm, 0.5 watt

R₁₀=150 ohms, 0.5 watt

R₁₁=1200 ohms, 1 watt

S₁=On-off switch; single-pole, single-throw

SP₁=Speaker

T₁=Oscillator coil for use with 7-115 pF tuning capacitor and 455-kHz intermediate-frequency transformer

T₂, T₃=Intermediate-frequency transformers, 455 kHz (permeability-tuned type may be used)

T₄=Output transformer for matching impedance of voice coil to 2500-ohm load

Circuit Description

This basic five-tube superheterodyne radio receiver operates directly from an ac power line or a dc supply of 117 volts. AC power inputs are converted to dc power by the 35W4 half-wave rectifier circuit. The receiver uses a series heater arrangement. With ON-OFF switch S₁ closed, the heater string is connected directly across the 117-volt input terminals. A 6.3-volt panel lamp I₁ connected between heater pins 3 and 6 of the 35W4

rectifier tube lights to indicate that power is applied to the receiver.

A ferrite-rod or loop antenna L and tuning capacitor C₁ select amplitude-modulated rf signals from the desired broadcast-band (550 to 1600 kHz) radio station and couple these signals to grid No. 3 (pin 7) of the 12BE6 pentagrid converter. A local-oscillator signal, developed by the resonant circuit formed by oscillator coil T₁ and variable capacitors C₅ and

29-1 AC/DC SUPERHETERODYNE RADIO RECEIVER (Cont'd)

Circuit Description (Cont'd)

C_6 , is also applied to the 12BE6 pentagrid converter, at grid No. 1 (pin 1). The modulated-rf and local-oscillator signals are mixed across the nonlinear impedance of the converter tube to produce the 455-kHz intermediate frequency used in the receiver. The antenna and oscillator tuning capacitors C_1 and C_3 are mechanically ganged so that the antenna and oscillator resonant circuits can be adjusted together to maintain the 455-kHz difference frequency for any dial setting in the broadcast-frequency band. Trimmer capacitors C_2 and C_4 are adjusted to assure that the desired tracking relationship is maintained across the band. Positive feedback to sustain oscillations is inductively coupled by T_1 from the cathode of the 12BE6 converter to the local-oscillator resonant circuit.

A single if stage, which uses a high-transconductance 12BA6 remote-cutoff pentode, provides the required amplification of the intermediate-frequency signals. This stage is made selective at 455 kHz by the double-tuned input and output transformers T_2 and T_3 . Audio-signal components are extracted from the if

signal by the second-detector circuit, which consists of the pin 6 diode section in the 12AV6 tube and associated components. (The pin 5 diode section of the 12AV6 is not used and is shorted to the tube cathode, pin 2.) The audio output from the detector is developed across the VOL. CONT. potentiometer R_6 , which provides manual adjustment of the output sound level of the receiver. The detector also develops a negative dc voltage proportional to the rf input across a 150-picofarad capacitor C_5 for automatic volume control in the receiver. This avc voltage is used as bias for the converter and if amplifier and automatically controls the gain of these stages.

The audio-signal voltage at the wiper arm of the VOL. CONT. potentiometer is amplified by the triode (audio-voltage-amplifier) section of the 12AV6 and is then used to drive the 50C5 audio output stage. The output stage develops the audio power required to produce an audible output from the speaker. Audio output transformer T_4 matches the 2500-ohm plate-load impedance of the 50C5 to the speaker voice coil.

29-2 AM/FM SUPERHETERODYNE RADIO RECEIVER

Circuit Description

This AM/FM radio receiver operates directly from either an ac power line or a dc supply of 117 volts. AC power inputs are converted to dc power by a 1N3756 silicon-rectifier half-wave power supply. The receiver uses a series heater string, which is connected across the 117-volt input when ON-OFF switch S_3 and interlock S_2 are closed. The interlock assures that power is automatically disconnected when the receiver is removed from the chassis.

AM or FM operation of the receiver is selected by means of switch S_1 . For AM operation (S_1 set to AM

position), amplitude-modulated rf signals in the AM broadcast band (550 to 1600 kHz) from the desired radio broadcast station are selected by antenna L_2 and tuning capacitor C_{25} . These signals are amplified and converted to the 455-kHz AM intermediate frequency by the 12BE6 pentagrid converter. Tuning capacitors C_{25} and C_{27} are mechanically ganged so that the antenna and local-oscillator sections of the converter can be tuned simultaneously to maintain the 455-kHz difference frequency for any station setting. Trimmer adjustments are provided by variable capacitors C_{26} and C_{28} .

29-2

AM/FM SUPERHETERODYNE RADIO RECEIVER (Cont'd)

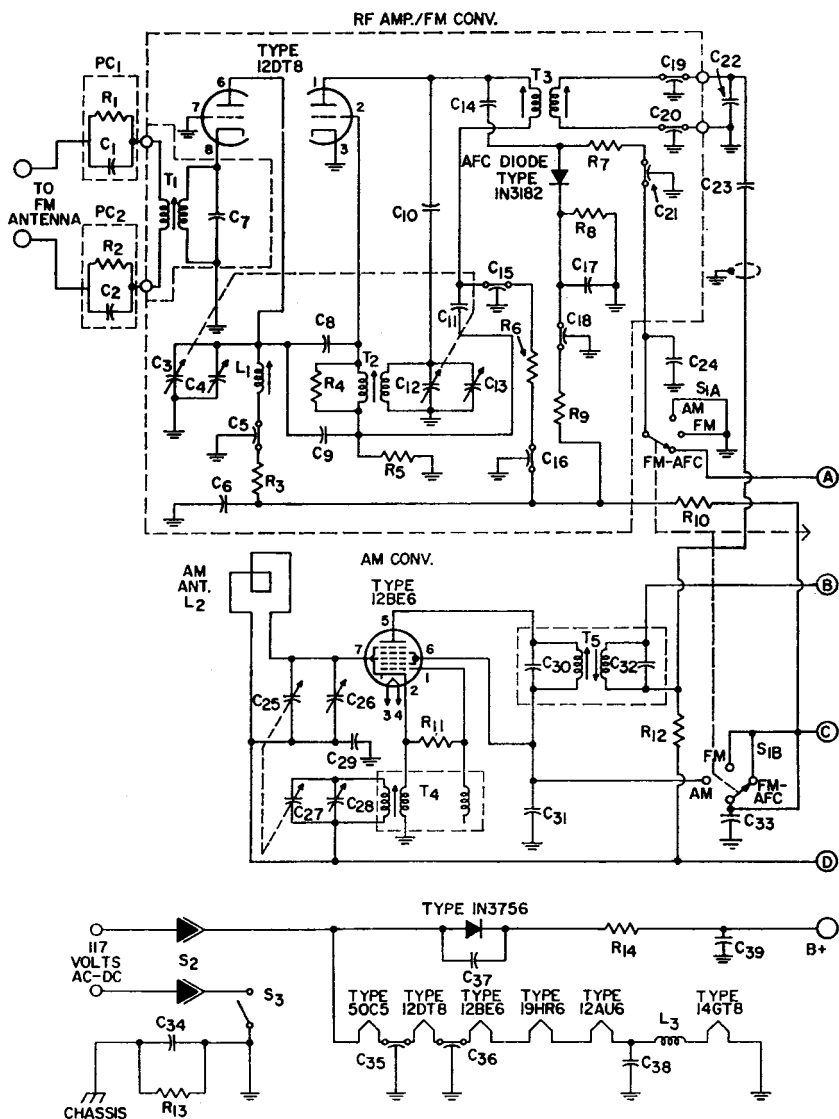

Parts List

C1 = Part of PC1
 C2 = Part of PC2
 C3, C12 = Ganged tuning capacitors; tune L1 and T2 to 88-108 MHz

C1, C13 = Trimmer capacitors, 1-7 pF
 C5, C16, C18 = 1000 pF, feed-through, 500 V
 C6 = 0.1 μ F, ceramic, 500 V

C7 = 36 pF, ceramic, 500 V
 C8, C14 = 6.8 pF, ceramic, 500 V
 C9 = 11 pF, ceramic, 500 V
 C10 = 68 pF, ceramic, 500 V

AM/FM SUPERHETERODYNE RADIO RECEIVER (Cont'd)

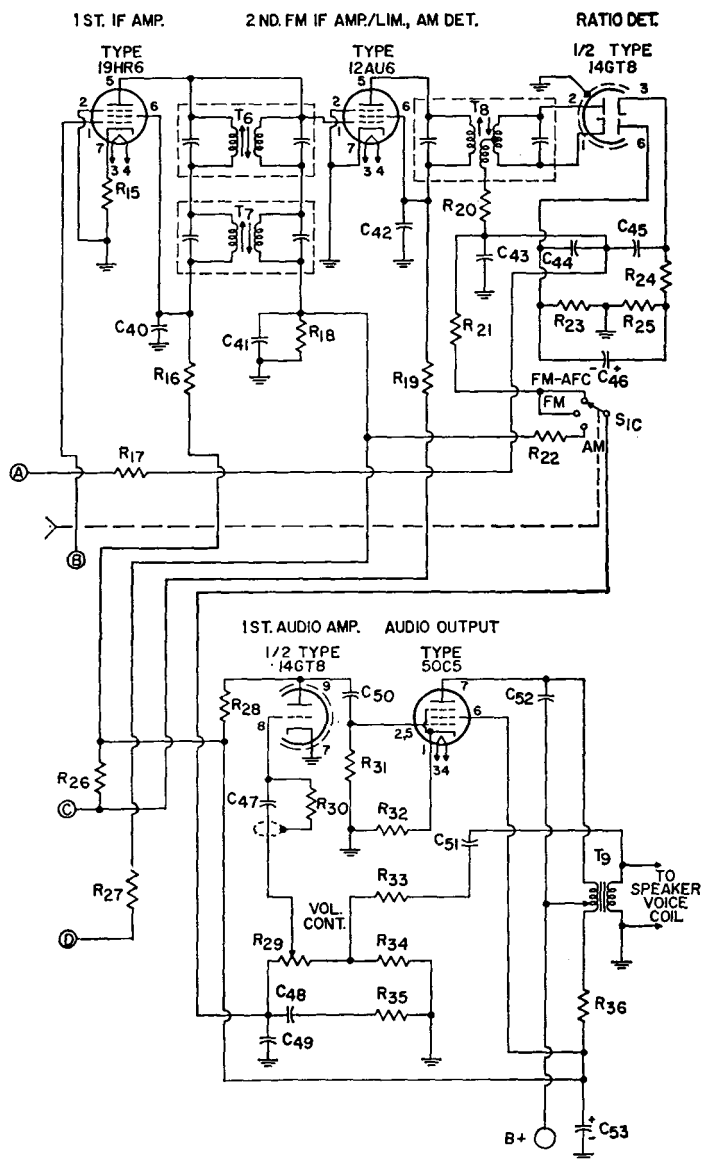

Parts List (Cont'd)

C₁₁ = 21 pF, ceramic, 500 V
 C₁₅ = 500 pF, feedthrough, 500 V
 C₁₇ = 0.22 μF, ceramic disc, 500 V

C₁₉, C₂₀ = 2 pF, feedthrough, 500 V
 C₂₁, C₃₅, C₃₆ = 2000 pF, feedthrough, 500 V

C₂₂ = IF transformer tuning capacitor; value, with cable capacitance, tunes T₉ to 10.7 MHz

29-2

AM/FM SUPERHETERODYNE
RADIO RECEIVER (Cont'd)

Circuit Description (Cont'd)

With switch S_1 in the FM or FM-AFC position, the FM tuner selects rf signals in the FM broadcast band (88 to 108 MHz) from the desired FM radio station, amplifies these signals, and converts them to the 10.7-MHz FM intermediate frequency. The rf-amplifier and converter stages of the tuner each use one section of a 12DT8 high-mu twin triode. Ganged tuning of the rf-amplifier and converter tuning capacitors, C_3 and C_{12} , assures that the converter local-oscillator frequency tracks the input tuning at 10.7 MHz above the center frequency of the FM channel selected. Trimmer adjustments are provided by variable capacitors C_4 and C_{15} .

The 19HR6 if amplifier is used in both FM and AM modes of operation. Depending upon the setting of selector switch S_1 , this stage amplifies the frequency-modulated 10.7-MHz intermediate-frequency output from the FM converter or the amplitude-modulated 455-kHz intermediate-frequency signal from the AM converter. Additional amplification of FM if signals is provided by the 12AU6 pentode stage, which is used as a combination second FM if amplifier and noise limiter. A portion of the 12AU6 stage is also used as a second detector circuit to extract the audio-signal components from the 455-kHz AM if signals. For this demodulation function, the cathode and control grid of the 12AU6 are used as the detector diode. The 10.7-MHz FM if signals are demodulated and amplitude distortion is removed by a ratio detector that uses the diode sections of a 14GT8 twin diode—high-

mu triode. Good selectivity in the if amplifier and detector at 10.7 MHz is provided by the double-tuned transformers T_3 , T_6 , and T_8 , and at 455 kHz by the double-tuned transformers T_5 and T_7 .

Depending upon the mode of operation, a section of S_1 selects the audio output from the AM detector or from the FM ratio detector. The selected audio output is amplified by an audio voltage amplifier which uses the high-mu triode section of a 14GT8 and a 50C5 audio output stage. The output stage provides the power necessary to produce the required speaker output. Transformer T_9 matches the 2500-ohm plate impedance of the 50C5 to the speaker voice coil. Manual adjustment of the receiver output is provided by the VOL. CONT. potentiometer R_{20} in the control-grid circuit of the audio voltage amplifier.

A negative dc voltage proportional to the input signal level is developed across R_{18} and C_{11} during either AM or FM operation of the receiver. This voltage is applied as bias to the control grid (pin 1) of the 19HR6 if amplifier and the signal grid (pin 7) of the 12BE6 AM converter to provide automatic gain control of the receiver in each mode of operation. With S_1 in the FM-AFC position, the 1N3182 AFC diode rectifies the voltage across the tertiary winding of the ratio-detector transformer T_8 . The resultant frequency-sensitive voltage, applied to the plate resonant circuits of the FM rf-amplifier and converter stages, provides automatic frequency control in the FM tuner.

29-2

AM/FM SUPERHETERODYNE
RADIO RECEIVER (Cont'd)

Parts List (Cont'd)

C_{22} =4700 pF, ceramic, 500 V	L_2 =Antenna, air-loop type with back cover	R_{27} =3.3 megohms, 0.5 watt
C_{24} =0.15 μ F, paper, 200 V	PC_1, PC_2 =Printed circuit; includes 0.5 megohm, 0.25-watt resistor and 470-picofarad, 500-volt capacitor; RCA Stock No. 104328	R_{29} =Volume control, potentiometer, 1 megohm, part of assembly with S_3
C_{25}, C_{27} =Ganged tuning capacitors; tune T_4 to 540-1650 kHz	R_1 =Part of PC_1	R_{30} =4.7 megohms, 0.5 watt
C_{26}, C_{28} =Trimmer capacitors, 12 pF	R_2 =Part of PC_2	R_{32} =150 ohms, 0.5 watt
$C_{29}, C_{32}, C_{33}, C_{47}$ =0.01 μ F, ceramic, 500 V	R_3 =2200 ohms, 0.5 watt	R_{33} =1500 ohms, 0.5 watt
C_{30} =Part of T_5	R_4 =1200 ohms, 0.5 watt	R_{34} =820 ohms, 0.5 watt
C_{31}, C_{46} =1000 pF, ceramic, 500 V	R_5, R_{21} =33000 ohms, 0.5 watt	R_{35} =3900 ohms, 0.5 watt
C_{32} =Part of T_5	R_6, R_{11} =22000 ohms, 0.5 watt	R_{36} =560 ohms, 0.5 watt
C_{34} =0.1 μ F, ceramic, 500 V	R_7, R_{23}, R_{31} =0.47 megohm, 0.5 watt	S_1 =AM-FM-AFC selector; 3-section slide switch
C_{37} =0.047 μ F, paper, 400 V	R_8 =3900 ohms, 0.5 watt	S_2 =Interlock
C_{39} =80 μ F, electrolytic, 150 V	R_9, R_{22} =47000 ohms, 0.5 watt	S_3 =ON-OFF switch, part of assembly with R_{36}
C_{40}, C_{42} =2700 pF, ceramic, 500 V	R_{10} =220 ohms, 0.5 watt	T_1 =FM antenna transformer
C_{41}, C_{43} =100 pF, ceramic, 500 V, NPO	R_{12}, R_{17} =1 megohm, 0.5 watt	T_2 =FM oscillator transformer
C_{44}, C_{45} =330 pF, mica, 500 V	R_{13} =0.22 megohm, 0.5 watt	T_3, T_6 =FM if transformer, 10.7 MHz
C_{46} =2 μ F, electrolytic, 50 V	R_{14} =100 ohms, wire-wound, 4 watts	T_4 =AM oscillator coil; with specified values of tuning and trimmer capacitance, tunes to 540 to 1600 kHz
C_{48} =0.01 μ F, paper, 200 V	R_{15}, R_{20} =68 ohms, 0.5 watt	T_5, T_7 =AM if transformer, 455 kHz
C_{50} =5600 pF, ceramic, 500 V	R_{16} =4700 ohms, 0.5 watt	T_8 =Ratio-detector transformer, 10.7 MHz
C_{51} =0.1 μ F, paper, 200 V	R_{18} =0.33 megohm, 0.5 watt	T_9 =Audio output transformer, matches impedance of speaker voice coil to 2500-ohm tube load
C_{52} =0.022 μ F, paper, 200 V	R_{19}, R_{24} =1000 ohms, 0.5 watt	
C_{53} =50 μ F, electrolytic, 150 V	R_{23}, R_{25} =6800 ohms, 0.5 watt	
L_1, L_3 =1 μ H, rf coil	R_{26} =220 ohms, 0.5 watt	

29-3

FM TUNER

Circuit Description

This three-stage FM tuner features a pair of 6CW4 nuvistor triodes operated in a low-noise, high-gain cascode rf-amplifier stage. The mixer and local-oscillator sections of the tuner use the pentode and triode sections, respectively, of a 6KE8 triode-pentode. The dc operating power for the tuner is obtained from a 180-volt, 20-milliampere supply. Power for the tube heaters is obtained from a 6.3-volt, 660-milliampere ac source.

The tuner uses a 300-ohm balanced antenna. Antenna transformer T_1 matches the 300-ohm antenna impedance to the input circuit of the cascode rf amplifier. Antenna tuning capacitor C_1 is adjusted to select the desired FM channel. The frequency-modulated rf signals are amplified by the cascode rf stage and coupled to

the control grid of the mixer stage. The local oscillator generates a signal, at a frequency 10.7 MHz above the center frequency of the selected FM channel, which is also applied to the control grid of the mixer stage. The rf and local-oscillator signals are mixed to produce the desired 10.7-MHz FM intermediate frequency. Ganged tuning of the antenna, mixer, and local-oscillator tuning capacitors, C_1, C_{13} , and C_{16} , assures that the local-oscillator frequency tracks the input tuning at 10.7 MHz above the selected FM channel. Capacitors C_9, C_{15} , and C_{19} are trimmer adjustments for the tuner. The double-tuned transformer T_2 selects the 10.7-MHz FM if signals at the plate of the mixer stages and couples them to the if-amplifier/limiter section of the FM receiver.

29-3

FM TUNER (Cont'd)

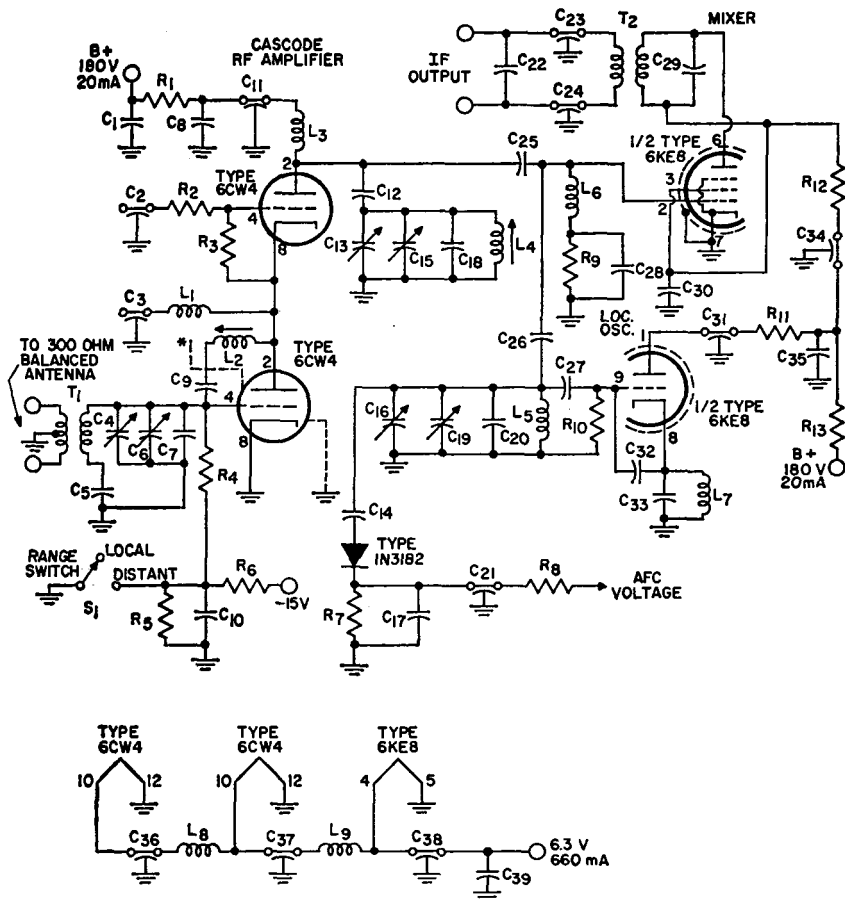

* A metal shield should be provided between grid and plate terminals on the 6CW4 socket.

Parts List

C₁, C₈, C₂₅, C₃₀=0.01 μ F, ceramic disc, 400 V

C₂, C₂₁=2000 pF, feedthrough, 400 V

C₃, C₁₁, C₂₁, C₂₄, C₂₆, C₂₇, C₃₃=1000 pF feedthrough, 400 V

C₄, C₁₃, C₁₀=Ganged tuning capacitor: 6.6-23 pF, 400 V; Miller No. 1461-BS or equiv.

C₅, C₉, C₂₈=1000 pF, ceramic, 400 V

C₆, C₁₅, C₁₉=Trimmer capacitors, 1-7.5 pF, ceramic, 400 V

C₇, C₁₈, C₃₅=10 pF, ceramic, 400 V

C₁₀=2000 pF, ceramic disc, 400 V

C₁₂, C₃₀=2000 pF, ceramic, 400 V

C₁₄, C₂₂=6.8 pF, ceramic, 400 V

C₁₇=0.22 μ F, ceramic, 400 V

C₂₀=18 pF, ceramic, 400 V

C₂₂=Capacitor inserted in place of tuning capacitor in secondary winding of T₂;

value with cable capacitance tunes output circuit of tuner to 10.7 MHz

C₂₃, C₂₄=2 pF feedthrough, 400 V

C₂₅=22 pF, ceramic, 400 V

C₂₆=2.2 pF, ceramic, 400 V

C₂₇=47 pF, ceramic, 400 V

C₂₉=Part of T₂

L₁=RF coil, 5 turns of No. 22 enamel wire close-

wound on $\frac{1}{4}$ -inch-diameter coil form

L₂=RF coil, 12 turns of No. 22 enamel wire close-

wound on $\frac{1}{4}$ -inch-diameter slug-tuned coil form; tuning slug = $\frac{3}{8}$ -inch-long Moldite No. 5101 ferrite or equiv.

L₃=RF choke, 4 μ H, J. W. Miller No. 70F396A1 or equiv.

L₄=RF coil, 3 turns of No. 16 enamel wire wound double-spaced on $\frac{1}{4}$ -inch-diameter slug-tuned coil form; tuning slug = $\frac{3}{8}$ -inch-long Moldite No. 5101 ferrite or equiv.

L₅=RF coil, 1- $\frac{1}{2}$ turns of No. 16 enamel wire close-

29-3

FM TUNER (Cont'd)

Parts List (Cont'd)

wound on $\frac{1}{4}$ -inch-diameter slug-tuned coil form; tuning slug= $\frac{3}{8}$ -inch-long Moldite No. 5101 ferrite or equiv.

L₆=RF choke, 2 μ H, Ohmite No. Z144 or equiv.

L₇=RF coil; 0.4 μ H; 20 turns of No. 26 enamel wire close-wound on a 0.47 megohm, 0.5-watt Allen-Bradley resistor or resistor of equivalent physical size

L₈, L₉=RF chokes; 1 μ H; 25 turns of No. 24 enamel wire close-wound on a 0.47-megohm, 1-watt Allen-

Bradley resistor or resistor of equivalent physical size

R₁, R₁₃=220 ohms, 0.5 watt

R₂=5 ohms, 0.5 watt

R₃, R₆=0.47 megohm, 0.5

watt

R₄, R₅, R₈=47000 ohms, 0.5

watt

R₅=0.1 megohm, 0.5 watt

R₇=3900 ohms, 0.5 watt

R₁₀=22000 ohms, 0.5 watt

R₁₁=4700 ohms, 0.5 watt

R₁₂=15000 ohms, 0.5 watt

S₁=AM/FM range switch;

open position is used for local stations, closed position for distant stations

T₁=Antenna transformer; primary: 2 turns of No. 32 wire with type B nylon insulation, Alpha No. 1860 or equivalent, center-tapped; secondary: 3 turns of No. 16 enamel wire; wound double-spaced on $\frac{1}{4}$ -inch-long coil form; tuning slug = $\frac{3}{8}$ -inch-long Moldite No. 5101 ferrite or equiv.

T₂=FM if transformer, 10.7 MHz; J. W. Miller 1451 or equiv.; capacitor in secondary should be replaced by C₂₂

Note: See general considerations for construction of high-frequency and broadband circuits on page 675.

29-4

THREE-STAGE IF AMPLIFIER/LIMITER AND DETECTOR

For Monaural or Stereo Tuner

Circuit Description

This three-stage if amplifier/limiter and detector circuit, when used with a front-end circuit such as that shown in circuit 25-3, makes possible an over-all tuner gain of 35 dB. The over-all bandwidth of the if-amplifier stages, between the 6-dB-down points, is 300 kHz, and the peak separation of the detector is 440 kHz. The circuit provides a signal-to-noise ratio of 20 dB for an input of 2.8 microvolts or 30 dB for an input of 4.1 microvolts. The 6HR6 and 6HS6 pentodes used in the if-amplifier stages have very high transconductance and a grid-No.1-to-plate capacitance substantially less than 0.01 picofarad and are, therefore, especially suited for use in FM if amplifiers and television sound if amplifiers. These pentodes operate from a 180-volt, 25-milliampere dc supply. Heater power for the pentodes and for the 6AL5 twin diode used in the ratio detector is obtained from a 6.3-volt ac source.

The frequency-modulated, 10.7-MHz intermediate-frequency signal from the mixer stage in the FM tuner is applied to the control grid of the first if-amplifier stage. This signal is amplified by the three transformer-

coupled amplifier stages and applied by transformer T₃ to the ratio detector. The doubled-tuned coupling transformers T₁, T₂, and T₃ provide the selectivity at 10.7 MHz and the band-pass characteristics required for optimum transfer of the frequency-modulated signal. Circuit stability is improved by the use of unbypassed cathode resistors in each amplifier stage. The first two if stages are basically amplifiers, although they provide some saturation limiting of large-level signals. The 3300-ohm screen-grid dropping resistors (R₂ and R₄) reduce the screen-grid voltages in these stages to obtain the desired limiting characteristics. The 6HR6 pentode used in the first if amplifier is a remote-cutoff tube and, if desired, this stage may be operated with agc bias. The 6HS6 pentodes used in the second and third if stages are sharp-cutoff tubes. In addition, the screen-grid voltage divider network (R₇ and R₈) for the third stage substantially reduces the screen-grid voltage so that the stage will provide both cutoff and saturation limiting of large-level signals. The limiting in the if stages helps remove any amplitude modulation from the frequency-mod-

29-4

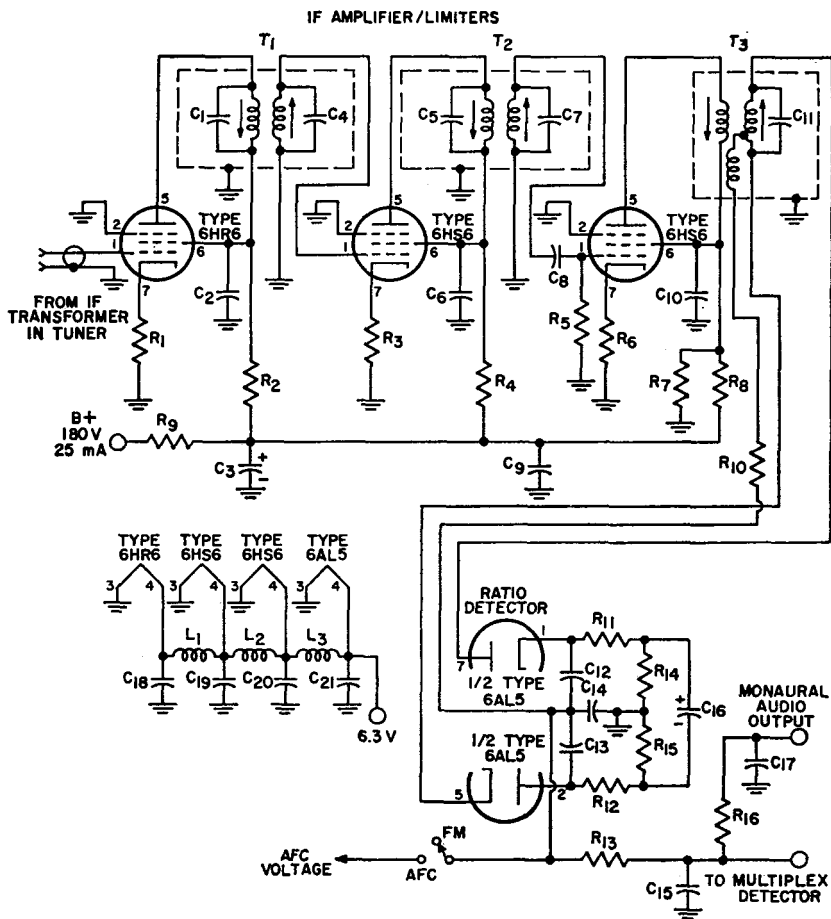
THREE-STAGE IF AMPLIFIER/LIMITER
AND DETECTOR (Cont'd)

Parts List

- | | | |
|--------------------------------------------------------------------------|-------------------------------------------------------|---------------------------------------------|
| C_1, C_4 —Part of T_1 | C_{12}, C_{13}, C_{18} —330 pF, ceramic disc, 400 V | R_8, R_{10} —100 ohms, 0.5 watt |
| C_5, C_6 —2200 pF, ceramic disc, 400 V | C_{14} —100 pF, ceramic disc, 400 V | R_7 —15000 ohms, 0.5 watt |
| C_2 —50 μ F, electrolytic, 450 V | C_{16} —2 μ F, electrolytic, 400 V | R_5 —22000 ohms, 0.5 watt |
| C_8, C_7 —Part of T_3 | C_{17} —1000 pF, ceramic disc, 400 V | R_9 —2200 ohms, 3 watts |
| C_8 —47 pF, ceramic disc, 400 V | L_1, L_2, L_3 —1 μ H | R_{11} —1200 ohms, 0.5 watt |
| $C_9, C_{18}, C_{19}, C_{20}, C_{21}$ —0.01 μ F, ceramic disc, 400 V | R_1, R_5 —68 ohms, 0.5 watt | R_{12} —390 ohms, 0.5 watt |
| C_{10} —1500 pF ceramic disc, 400 V | R_2, R_4, R_{13} —3300 ohms, 0.5 watt | R_{14}, R_{15} —6800 ohms, 0.5 watt |
| C_{11} —Part of T_3 | R_3 —0.1 megohm, 0.5 watt | R_{16} —68000 ohms, 0.5 watt |
| | | T_1, T_2 —IF transformers, 10.7 MHz |
| | | T_3 —Ratio-detector transformer, 10.7 MHz |

Note: Tube shields may be required if regeneration is encountered. See general considerations for construction of high-frequency and broad-band circuits on page 675.

29-4 THREE-STAGE IF AMPLIFIER/LIMITER AND DETECTOR (Cont'd)

Circuit Description (Cont'd)

ulated signals.

The 6AL5 ratio-detector circuit provides additional noise limiting of the FM signal and demodulates this signal to recover the audio information. The detector circuit provides the

input to the audio amplifiers of a monaural receiver or to the multiplex detector in a stereo system. The RC network (R_{16} and C_{17}) in the monaural output lead provides the desired de-emphasis of high audio frequencies.

29-5 FM STEREO MULTIPLEX ADAPTER

Circuit Description

This FM stereo multiplex adapter demodulates composite multiplex signals from an FM tuner and separates these signals into left- and right-channel inputs for stereo audio-output stages. The dc operating power for the 12AX7A and 6CL8A twin triodes used in the adapter circuit is obtained from a 180-volt, 15-milliamperes supply. Power for the dual heaters of the 12AX7A and the single heater of the 6CL8A is obtained from a 6.3-volt source.

The composite signal applied to the multiplex adapter from the ratio detector (or discriminator) in an FM receiver includes a 19-kHz pilot-frequency (multiplex-reference) component and sum ($L + R$) and difference ($L - R$) components of left- and right-channel audio signals. The $L + R$ signal is the demodulated in-phase combination of the left- and right-channel audio information used to modulate the main carrier frequency of the receiver. The $L - R$ signal is the out-of-phase combination of the left- and right-channel information and is used to amplitude-modulate a 38-kHz subcarrier. This subcarrier is suppressed in the FM tuner so that only the $L - R$ sideband components of the amplitude-modulated signal remain.

The composite input signal is amplified by the 12AX7A triode section in the input stage of the adapter. The high input impedance of this stage prevents excessive loading of the ratio detector. The 67-kHz trap (L_1 and C_2) in the cathode circuit of this

stage eliminates any SCA (storecast allocation) signal components that may be included in the composite signal. The composite signal is coupled from the plate of the input stage to the control grid of the 6CL8A triode section used in a signal-separation driver. This stage operates as a cathode follower for the $L + R$ audio components and the $L - R$ subcarrier sideband components. The $L + R$ audio components are developed across the MATRIX BALANCE ADJ. potentiometer R_{18} and coupled from the wiper arm of this potentiometer to the output resistor matrix network R_{19} through R_{22} . A 3300-picofarad capacitor C_{16} in the coupling circuit filters out any 19-kHz pilot-frequency components or 38-kHz subcarrier sideband components that may be developed across potentiometer R_{18} . The $L - R$ sideband components are coupled from the cathode of the signal-separation driver to the center tap of the secondary winding of the transformer T_2 in the peak detector. The 38-kHz band-pass coil L_2 and the 67-kHz series-resonant trap C_3 and L_3 assure maximum signal transfer of the $L - R$ sideband components with minimum interference from storecast signals.

The 19-kHz double-tuned transformer T_1 in the plate circuit of the signal-separation driver presents a highly selective load to the 19-kHz pilot-frequency component included in the composite multiplex signal and couples this 19-kHz component to the pilot-frequency doubler. The doubler

29-5 FM STEREO MULTIPLEX ADAPTER (Cont'd)

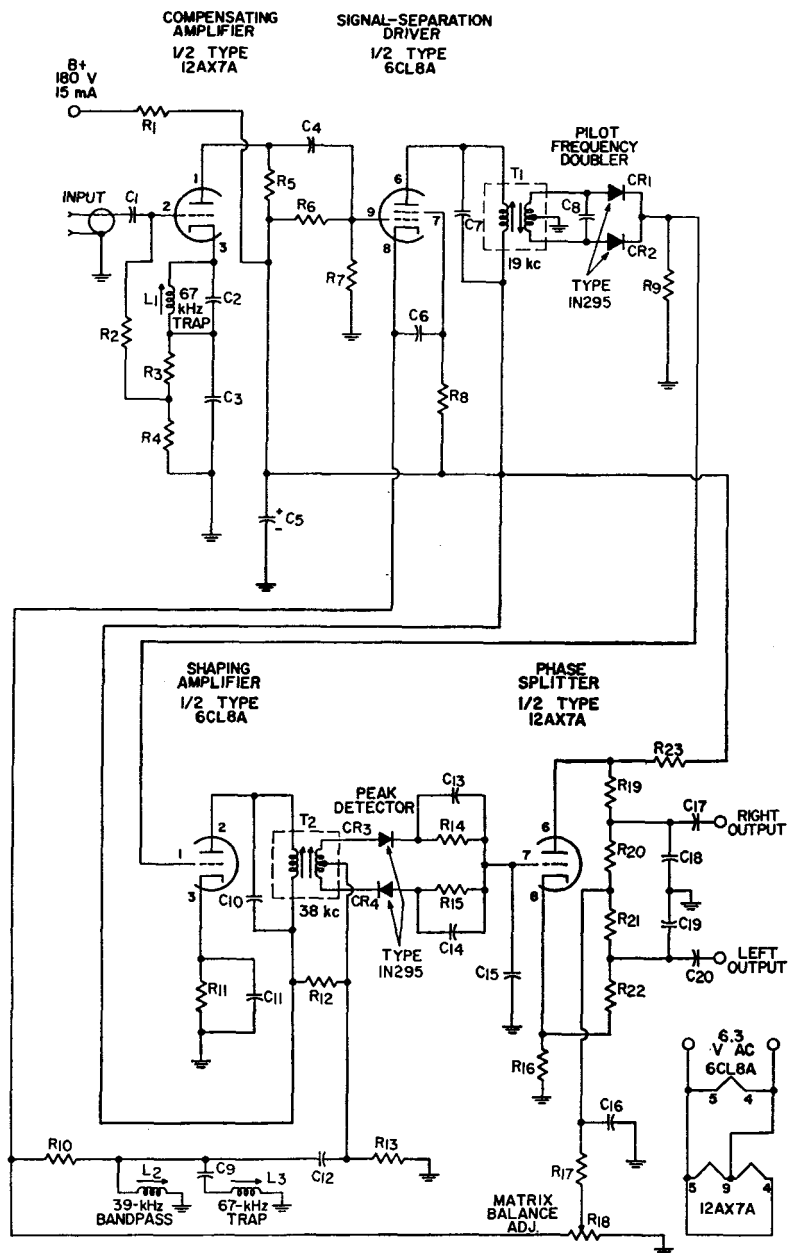

29-5 FM STEREO MULTIPLEX ADAPTER (Cont'd)

Parts List

C ₁ , C ₁₁ , C ₁₂ , C ₁₃ , C ₁₄ , C ₁₇ , C ₂₀ =0.01 μ F, ceramic, 500 V	RCA stock No. 111047 or equiv.	R ₁₁ =4700 ohms, 0.5 watt
C ₂ , C ₉ =2200 pF, film, 500 V, N150	L ₂ =RF coil, 38-kHz band- pass, RCA stock No. 111048 or equiv.	R ₁₂ =1.2 megohms, 0.5 watt
C ₃ , C ₁₈ , C ₁₉ =270 pF, ceramic, 500 V, N750	R ₁ =330 ohms, 1 watt	R ₁₃ =0.15 megohm, 0.5 watt
C ₄ =0.047 μ F, paper, 200 V	R ₂ =0.56 megohm, 0.5 watt	R ₁₆ , R ₁₇ , R ₂₃ =22000 ohms, 0.5 watt
C ₅ =40 μ F, electrolytic, 450 V	R ₃ =1500 ohms, 0.5 watt	R ₁₈ =Potentiometer, balance adjustment, 10000 ohms, RCA stock No. 111044 or equiv.
C ₆ =0.22 μ F, paper, 400 V	R ₄ =15000 ohms, 0.5 watt	R ₁₉ , R ₂₀ , R ₂₁ , R ₂₂ =0.1 megohm, 0.5 watt
C ₇ , C ₈ =1500 pF, film, 500 V, N150	R ₅ =68000 ohms, 0.5 watt	T ₁ =19-kHz transformer, RCA stock No. 111045 or equiv.
C ₁₀ =1000 pF, film, 500 V, N150	R ₆ =3.9 megohms, 0.5 watt	T ₂ =38-kHz transformer, RCA stock No. 111046 or equiv.
C ₁₅ =470 pF, ceramic, 500 V	R ₇ =1 megohm, 0.5 watt	
C ₁₆ =3300 pF, ceramic, 500 V	R ₈ , R ₁₀ =10000 ohms, 0.5 watt	
L ₁ , L ₃ =RF coil, 67-kHz trap.	R ₉ , R ₁₄ , R ₁₅ =47000 ohms, 0.5 watt	

Note: See general considerations for construction of high-frequency and broadband circuits on page 675.

Circuit Description (Cont'd)

circuit, which consists of two 1N295 diodes (CR₁ and CR₂) in a full-wave rectifier configuration, doubles the pilot frequency to regenerate the 38-kHz subcarrier required for demodulation of the L - R sideband components.

The 38-kHz output of the doubler is amplified by the 6CL8A triode section used in the shaping amplifier and reshaped to a sine wave by the tuned primary of the peak detector transformer T₂. In the secondary of T₂, the 38-kHz subcarrier is recombined with the L - R sideband components from the cathode of the signal-separation driver. This combined signal is then demodulated by the 1N295 detector diodes CR₃ and CR₄ to obtain the L - R audio signal.

The L - R audio signal is applied to the control grid of the 6CL8A section used in a phase-splitter circuit.

The cathode and plate outputs of the phase splitter are equal in amplitude and opposite in phase so that one output represents an L - R signal and the other output represents a - L + R signal. These signals are applied to the output-resistor matrix network where they are added to the L + R audio signal from the cathode circuit of the signal-separation driver. In the summation of the L + R and L - R audio signal, the R components are canceled, and the resultant obtained is the left-channel audio output. The summation of the L + R and - L + R signals results in cancellation of the L components so that only the right-channel audio output is obtained. These outputs are then applied to the stereo receiver left- and right-channel audio-output stages, respectively.

29-6 PREAMPLIFIER FOR AMATEUR RECEIVER

For 15-, 10-, and 6-Meter (21-, 30-, and 50-MHz)
Amateur Bands and 27-MHz Citizens Band

Circuit Description

In this preamplifier, two 6CW4 high- μ nuvistor triodes are used in a high-gain, low-noise cascode rf-amplifier stage that adds 25 to 35 dB of gain ahead of a receiver operated on the 6-, 10-, or 15-meter amateur band or on the 27-MHz citizens band. This added gain, together with the

low noise figure (approximately 5 dB) of the preamplifier, substantially increases both the sensitivity and the signal-to-noise ratio of the receiver. The preamplifier operates from a dc plate supply of 150 volts at 5 milliamperes. The tube heaters require an ac power input of 6.3 volts at 0.26

29-6 PREAMPLIFIER FOR AMATEUR RECEIVER (Cont'd)

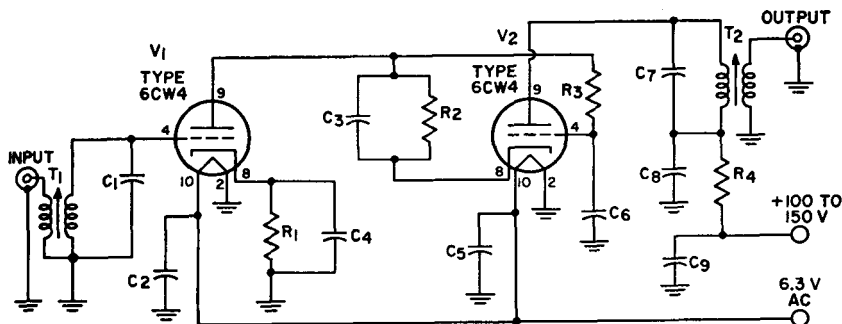

ALIGNMENT DATA

Operating Frequency	Tune T_1 to:	Tune T_2 to:
21 MHz	21.25 MHz	21.22 MHz
27 MHz	30 MHz	27 MHz
30 MHz	32 MHz	29.5 MHz
50 MHz	51 MHz	50 MHz

Parts List

C_1, C_7 —See Note 1
 $C_2, C_3, C_4, C_5, C_6, C_8, C_9$
 $C_2 = 0.001 \mu\text{F}, 500 \text{ V},$
 ceramic

$R_1, R_2 = 100 \text{ ohms}, 0.5 \text{ watt}$
 $R_3 = 0.47 \text{ megohm}, 0.5 \text{ watt}$
 $R_4 = 1000 \text{ ohms}, 0.5 \text{ watt}$
 T_1 —Input transformer (slug-tuned); matches preamplifier to 52-ohm input line (for 300-ohm input line, double number of turns in

primary); wound from #32 copper enamel wire on slug-tuned form having $\frac{1}{4}$ -inch outer diameter: primary, $1\frac{1}{2}$ turns; secondary, 18 turns for operation at 21, 27, or 30 MHz or 10 turns for operation at 50 MHz
 T_2 —Output transformer (slug-tuned); matches preamplifier to 72-ohm output lines (use of other than a

72-ohm line between preamplifier output and receiver input is not recommended); wound from #32 copper enamel wire on slug-tuned form having $\frac{1}{4}$ -inch outer diameter; primary, 18 turns for operation at 21, 27, or 30 MHz or 10 turns for operation at 50 MHz, secondary, $1\frac{1}{2}$ turns.

- Notes: 1. For operation at 21 or 27 MHz, use 6.8-pF 500-volt capacitors for C_1 and C_7 ; for operation at 30 MHz, use 5-pF 500-volt capacitors for C_1 and C_7 ; for operation at 50 MHz, use 5-pF 500-volt capacitor for C_1 and 6.8-pF 500-volt capacitor for C_7 .
 2. See general considerations for construction of high-frequency and broadband circuits on page 675.

Circuit Description (Cont'd)

ampere. These small power requirements can usually be provided by the receiver.

Input transformer T_1 matches the high input impedance of the preamplifier to a 72-ohm or 300-ohm antenna. When a 72-ohm antenna is used, the primary of T_1 consists of a $1\frac{1}{2}$ -turn link wound about the hot end of the secondary coil. For a 300-ohm antenna, a 3-turn link is used. The secondary of T_1 is an 18-turn coil for operation at 10 or 15 meters or on the citizens band. At 6 meters, a 10-turn secondary coil is used. The unit is normally connected to the an-

tenna cable by means of a coaxial connector. If a balanced antenna system is used, however, terminal strips for the twin leads may be used instead of the coaxial connector. In this latter case, the input link (primary of T_1) is not grounded.

Nuvistors V_1 and V_2 are operated in a stacked (cascode) arrangement in series with the $B+$ supply. The input is coupled by T_1 to the control grid of V_1 , which is essentially a grounded-cathode amplifier. The output of V_1 is applied to the cathode of V_2 , which is basically a grounded-grid amplifier. The inherent stability

29-6 PREAMPLIFIER FOR AMATEUR RECEIVER (Cont'd)

Circuit Description (Cont'd)

of this type of arrangement, together with the ample decoupling and bypassing networks included in the circuit, provides assurance that the preamplifier will not break into oscillation.

The output of V_2 is developed across the primary coil of output transformer T_2 . This coil is identical

to the secondary coil of input transformer T_1 . The secondary of T_2 consists of a $1\frac{1}{2}$ -turn link about the primary coil. This link matches the output of the preamplifier to a 75-ohm receiver input cable. (The maximum length of coaxial cable between receiver and preamplifier should not exceed 12 inches.)

29-7

CODE-PRACTICE OSCILLATOR

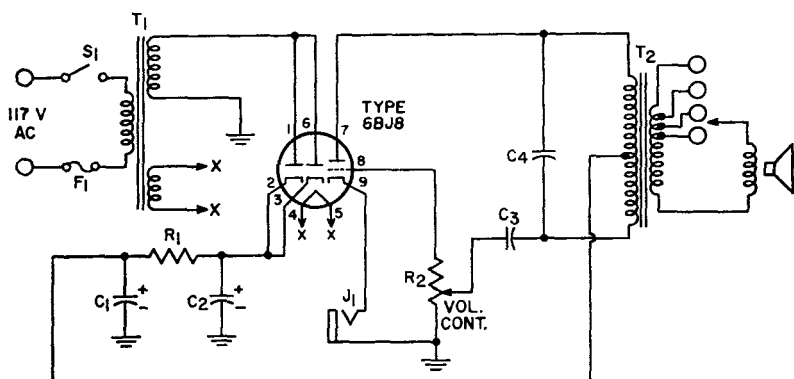

Note: Any two terminals of the secondary of T_2 that give the desired tone may be selected. Adjustment of volume control may cause a slight change in tone.

Parts List

$C_1, C_2=20\ \mu\text{F}$, electrolytic,
150 V
 $C_3=0.001\ \mu\text{F}$, paper, 200 V
 $C_4=0.03\ \mu\text{F}$, paper, 200 V
 $F=\frac{1}{8}$ ampere

J_1 =Input jack for key
 $R_1=1500$ ohms, 1 watt
 R_2 =Potentiometer, 0.1
megohm, 0.5 watt

T_1 =Power transformer, 125
volts rms, 15 ma; 6.3 volts,
0.6 ampere
 T_2 =Output transformer,
universal

Circuit Description

This code-practice oscillator operates from a 117-volt ac power line. When ON-OFF switch S_1 is closed, the 117-volt ac input power is stepped up to 125 volts across the upper secondary winding of power transformer T_1 and is stepped down to 6.3 volts across the lower secondary winding. The 6.3-volt winding provides the operating power for the heater of the 6BJ8 twin diode-triode used in the circuit. The diode sections of the 6BJ8 are connected to operate as a single diode in a half-wave rectifier circuit that converts the ac power across the

125-volt winding of T_1 to dc operating power for the 6BJ8 triode section. This triode section is used as the amplifier tube in a simple audio-oscillator stage.

Operation of the oscillator stage is controlled by a telegraph key, which is connected into the circuit by means of jack J_1 . When the key is closed, the triode section of the 6BJ8 supplies energy to the oscillator resonant circuit formed by capacitor C_1 and the effective inductance of the primary of output transformer T_2 . This circuit then resonates to pro-

29-7 CODE-PRACTICE OSCILLATOR (Cont'd)

Circuit Description (Cont'd)

duce an audio signal that is coupled by transformer T_2 to the speaker to produce an audible indication of the keying. Positive feedback to sustain oscillation is developed by the auto-transformer action of the tapped primary of transformer T_1 .

Output transformer T_2 is a universal type which contains multiple taps on the secondary winding. These taps enable the transformer to match the oscillator output impedance to

different values of speaker voice-coil impedance. The speaker impedance and transformer terminals used, however, affect the effective inductance in the primary of T_1 and, thus, the tone of the audio output. Volume-control potentiometer R_2 adjusts the level of the audio output. Adjustment of potentiometer R_2 varies the loading on the oscillator resonant circuit and may also cause a slight change in the tone of the audio output.

29-8

INTERCOMMUNICATION SET

With Master Unit and Two or More Remote Units

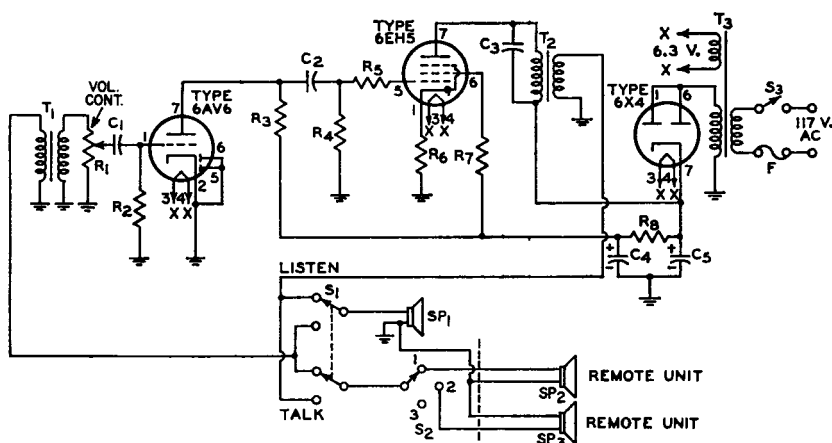

- Notes: 1. The leads from the LISTEN-TALK switch S_1 to T_1 and T_2 should be kept as far apart as possible to prevent undesirable regenerative effects.
2. Connections to the remote speaker units should be made with low-resistance wire, preferably with shielded "intercom" cable.

Parts List

$C_1, C_2=0.0022 \mu\text{F}$, paper, 200 V.

$C_3=0.005 \mu\text{F}$, paper, 200 V.

$C_4, C_5=60 \mu\text{F}$, electrolytic, 150 V.

F_1 =Fuse, 1 ampere

R_1 =Volume control, potentiometer, 0.5 megohm, audio taper, attached to switch S_1

$R_2=6.8$ megohms, 0.5 watt

$R_3, R_4=0.47$ megohm, 0.5 watt

$R_5=10000$ ohms, 0.5 watt

$R_6, R_7=68$ ohms, 0.5 watt

$R_8=2200$ ohms, 1 watt

S_1 =Talk-listen switch, double-pole, double-throw

S_2 =Station Selector, rotary switch

S_3 =On-off switch, single-pole, single-throw; attached to volume-control potentiometer

SP_1, SP_2, SP_3 =Speaker; permanent-magnet; voice-coil impedance, 3 to 4 ohms

T_1 =Input transformer, 4-ohm primary, 25000-ohm secondary, Knight 54A1492 or equiv.

T_2 =Output transformer, 3000-ohm primary, 4-ohm secondary, Knight 54A2371 or equiv.

T_3 =Power transformer, 125 volts rms, 50 mA., 6.3 volts rms, 2 amperes, Knight 54A1411 or equiv.

29-8 INTERCOMMUNICATION SET (Cont'd)

Circuit Description

This simple "intercom" set can be used to achieve reliable voice communications, at normal speaking levels, between any two points in a normal-size house. The system consists of a master unit, centrally located at the hub of household activity, interconnected by low-loss cabling to remote units located at points (e.g., garage, attic, and cellar) beyond the range of normal voice levels. An audio amplifier, which includes a 6AV6 voltage-amplifier stage and a 6EH5 power-output stage, provides the amplification necessary to overcome the attenuation of voice levels by system cabling. A 6X4 half-wave rectifier circuit converts the 117-volt ac input power to the dc power required for operation of the amplifier stages. A 6.3-volt secondary winding on the power transformer (T_1) in the rectifier circuit provides heater power for the amplifier and rectifier tubes.

The speaker at each intercom station is used for both talk and listen functions. The talk-listen switch S_1 at the master location establishes the talk or listen mode for all stations. The voice communications are initiated from the master unit. Switch S_1 is depressed to the TALK position, and the initiator talks into the master-unit speaker. The audio (voice-signal) voltage that is then developed across the speaker voice coil is coupled by input transformer T_1 to the control grid of the 6AV6 audio amplifier. Selector switch S_2 connects

the desired remote unit into the intercom system. With S_1 depressed to the TALK position, the remote unit speaker is automatically connected to the audio amplifier output for listen-mode operation. When S_1 is in the LISTEN position, the master-unit speaker is connected in the listen mode, and the remote-unit speaker is connected to the amplifier input. A reply from the remote unit is then coupled from the remote speaker by transformer T_1 to the control grid of the 6AV6 audio amplifier.

Transformer T_1 matches the voice-coil impedance of the 4-ohm permanent-magnet speaker (of either master or remote unit) to the 25000-ohm input impedance of the 6AV6 amplifier stage. This stage and the 6EH5 audio output stage amplify the audio (voice) signals received from one location (the master unit or one of the remote units) to develop the audio power required to produce an audible output from the speaker at another location. Output transformer T_2 matches the 3000-ohm plate-circuit impedance of the output stage to the 4-ohm voice-coil impedance of the speaker (master-unit or remote-unit) to which the communication is directed, as determined by the settings of switches S_1 and S_2 . The VOL. CONT. potentiometer R_1 in the input circuit of the 6AV6 audio amplifier stage provides the volume-control adjustment for the system.

29-9 HIGH-FIDELITY AUDIO AMPLIFIER

Class AB₁; Power Output, 15 Watts

Circuit Description

This high-fidelity audio power amplifier can deliver 15 watts of rms output power with less than 0.4 per cent total harmonic distortion and less than 1.5 per cent intermodulation distortion. The frequency response of the amplifier is flat within ± 0.5 dB from 20 Hz to 60 kHz, and the sensi-

tivity is such that the rated output of 15 watts is obtained for an input of 1.2 volts rms. The total hum and noise, with the input shorted, is 84 dB below 15 watts. The circuit operates from a 117-volt ac power line. The transformer-coupled ac input power is converted to dc operating

29-9 HIGH-FIDELITY AUDIO AMPLIFIER (Cont'd)

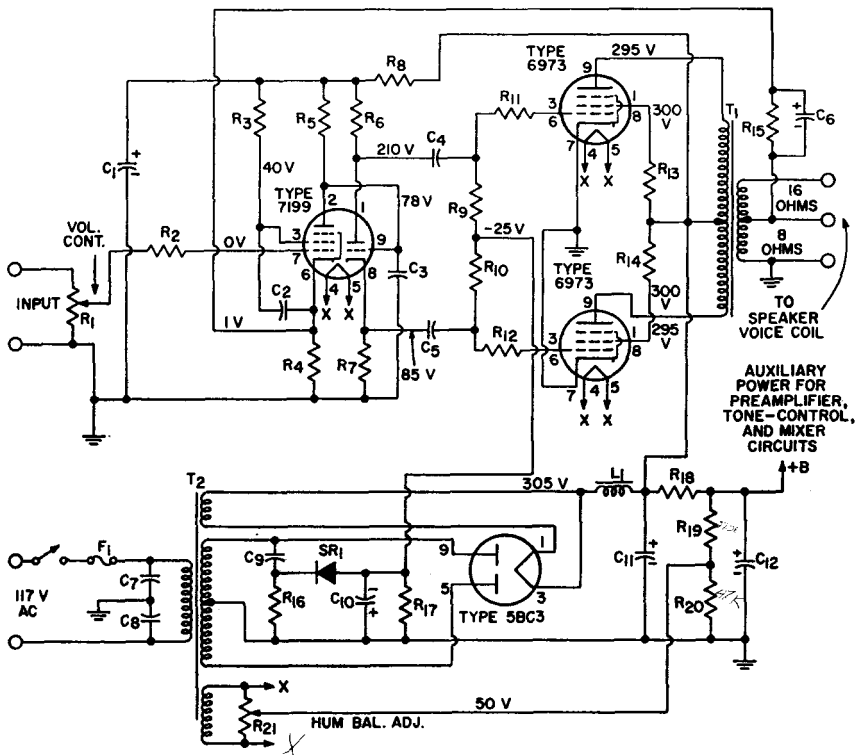

Parts List

$C_1=40 \mu\text{F}$, electrolytic, 450 V.
 $C_2, C_4, C_5=0.25 \mu\text{F}$, paper, 400 V.
 $C_3=3.3 \text{ pF}$, ceramic or mica, 600 V.
 $C_6=150 \text{ pF}$, ceramic or mica, 400 V.
 $C_7, C_9=0.05 \mu\text{F}$, paper, 400 V.
 $C_8=0.02 \mu\text{F}$, paper 600 V.
 $C_{10}=100 \mu\text{F}$, electrolytic, 50 V.
 $C_{11}=80 \mu\text{F}$, electrolytic, 450 V.
 $C_{12}=40 \mu\text{F}$, electrolytic, 450 V.
 F_1 =Fuse, 3 amperes
 L_1 =Choke, 3 H, 160 mA, dc resistance 75 ohms or less, Triad C-13X or equiv.

R_1 =Volume control, potentiometer, 1 megohm
 $R_2=10000$ ohms, 0.5 watt
 $R_3=0.82$ megohm, 0.5 watt
 $R_4=820$ ohms, 0.5 watt
 $R_5=0.22$ megohm, 0.5 watt
 $R_6, R_7=15000$ ohm ± 5 per cent, 2 watts
 $R_8=3900$ ohms, 2 watts
 $R_9, R_{10}=0.1$ megohm, 0.5 watt
 $R_{11}, R_{12}=1000$ ohms, 0.5 watt
 $R_{13}, R_{14}=100$ ohms, 0.5 watt
 $R_{15}=8200$ ohms, 0.5 watt
 $R_{16}=15000$ ohms, 1 watt
 $R_{17}=68000$ ohms, 0.5 watt
 $R_{18}=47000$ ohms, 2 watts
 $R_{19}=0.27$ megohm, 1 watt
 $R_{20}=47000$ ohms, 0.5 watt

R_{21} =Hum balance adjustment, potentiometer, 100 ohms, 0.5 watt
 SR_1 =Selenium rectifier, 20 mA, 135 volts rms
 T_1 =Output transformer, (having 8-ohm tap for feedback connection) for matching impedance of voice coil to 6600-ohm plate-to-plate tube load; 50 watts; frequency response, 10 to 50000 Hz; Stancor A-8056 or equiv.
 T_2 =Power transformer, 360-0-360 volts rms, 120 mA; 6.3 V., 3.5 A.; 5 V., 3 A.; Stancor 8410 or equiv. (see Note 1)

Notes: 1. For stereo operation from a single power supply, the power transformer T_2 must be replaced by one that has a higher current rating. A Stancor Type 6315 or equivalent (370-0-370 volt rms, 275 mA) is recommended.

2. If the amplifier oscillates or "motorboats," reverse ground and feedback connections in secondary of output transformer T_1 .

29-9 HIGH-FIDELITY AUDIO AMPLIFIER (Cont'd)

Circuit Description (Cont'd)

power for the amplifier stages by the 5BC3 full-wave rectifier. Heater power for the amplifier tubes and the rectifier are obtained from the 6.3-volt and 5-volt secondary windings, respectively, on the rectifier power transformer (T_2).

A high-gain pentode voltage amplifier is used as the input stage for the audio power amplifier. The output of this stage is direct-coupled to the control grid of a triode split-load type of phase inverter. The use of direct coupling between these stages minimizes phase shift and, consequently, increases the amount of inverse feedback that may be used without danger of low-frequency instability. A low-noise 7199 tube, which contains a high-gain pentode section and a medium-mu triode section in one envelope, fulfills the active-component requirement for both the pentode input stage and the triode phase inverter. Potentiometer R_1 in the input circuit of the 7199 pentode section is the volume control for the amplifier.

The plate and cathode outputs of the phase inverter, which are equal in amplitude and opposite in phase, are used to drive a pair of pentode-connected 6973 beam-power tubes used in a class AB_1 push-pull output stage. The 6973 output tubes are biased for class AB_1 operation by the fixed negative voltage applied to the control-grid circuit from the rectifier circuit. Fixed bias is used because a class AB amplifier provides highest efficiency

and least distortion for this bias method.

Transformer T_1 couples the audio-amplifier output to the speaker. The taps on the secondary of this transformer match the plate-to-plate impedance of the output stage to the voice-coil impedance of an 8- or 16-ohm speaker. Negative feedback of 19.5 dB is coupled from the secondary of the output transformer (speaker voice coil) to the cathode of the input stage to reduce distortion and to improve circuit stability.

Fixed-bias operation of the output stage requires that the power supply provide very good voltage regulation because the plate current of the 6973 tubes varies considerably with the signal level. The conventional choke-input type of power supply used provides the required regulation. The fixed bias for the output stage is obtained from one-half the high-voltage secondary winding of power transformer T_2 through a capacitance-resistance voltage divider and the 20-milliampere, 135-volt selenium rectifier. Potentiometer R_{21} connected across the 6.3-volt secondary winding of transformer T_2 provides a hum balance adjustment for the audio power amplifier. The wiper arm of this potentiometer is connected to the junction of a resistive voltage divider across the output of the power supply. The resulting positive bias voltage applied to the tube heaters minimizes heater-to-cathode leakage and substantially reduces hum.

29-10 HIGH-FIDELITY AUDIO AMPLIFIER

Class AB_1 ; Power Output, 30 Watts

Circuit Description

This audio power amplifier can deliver 30 watts of rms output power with less than 0.7 per cent total harmonic distortion and less than 1.5 per cent intermodulation distortion. The frequency response of the amplifier is flat within ± 0.5 dB from 15

Hz to 40 kHz. The total hum and noise, with the input shorted, is 85 dB below 30 watts. The rated output of 30 watts is obtained for an input of 1 volt rms.

The 30-watt amplifier is essentially identical to the 15-watt ampli-

29-10 HIGH-FIDELITY AUDIO AMPLIFIER (Cont'd)

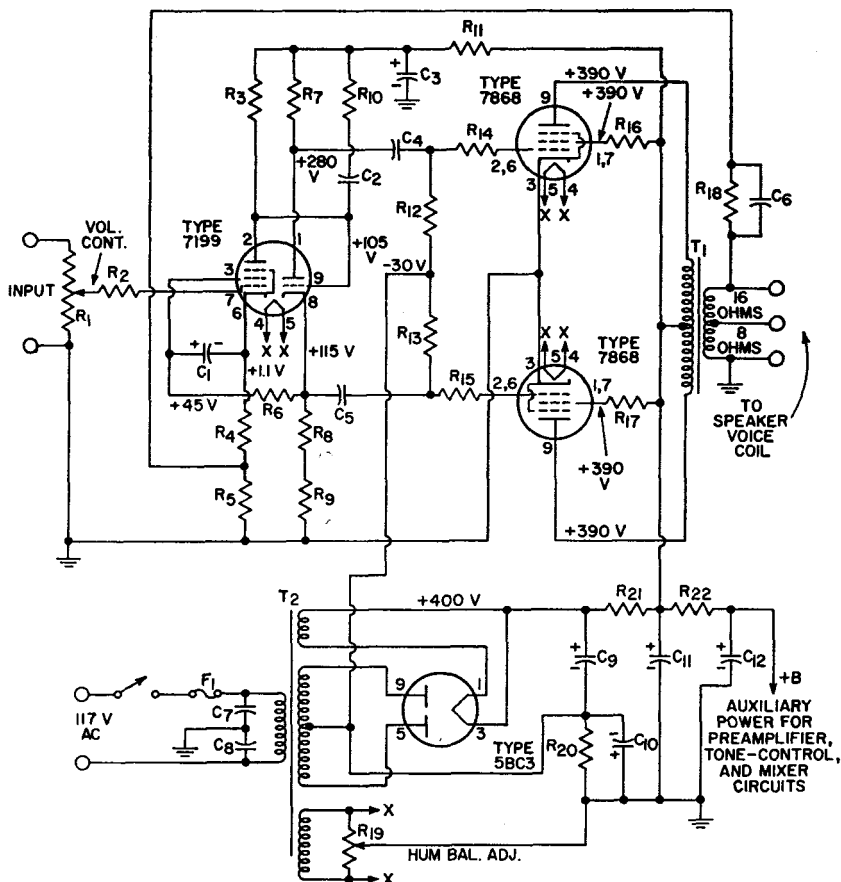

Parts List

$C_1=25 \mu\text{F}$, electrolytic, 50 V
 $C_2=22 \text{ pF}$, ceramic or mica, 600 V
 $C_3=80 \mu\text{F}$, electrolytic, 450 V
 $C_4, C_5=0.25 \mu\text{F}$, paper, 600 V
 $C_6=0.01 \mu\text{F}$, paper, 600 V
 $C_7, C_8=0.05 \mu\text{F}$, paper, 600 V
 $C_9, C_{11}=40 \mu\text{F}$, electrolytic, 500 V
 $C_{10}=100 \mu\text{F}$, electrolytic, 50 V
 $C_{12}=20 \mu\text{F}$, electrolytic, 450 V
 F_1 =Fuse, 3 amperes, 150 V
 R_1 =Volume control, potentiometer, 1 megohm
 $R_2=10000 \text{ ohms}$, 0.5 watt
 $R_3=0.22 \text{ megohm}$, 0.5 watt

$R_4=820 \text{ ohms}$, 0.5 watt
 $R_5=10 \text{ ohms}$, 0.5 watt
 $R_6=0.18 \text{ megohm}$, 0.5 watt
 $R_7, R_8=15000 \text{ ohms} \pm 5 \text{ per cent}$, 2 watts
 $R_9=1000 \text{ ohms}$, 0.5 watt
 $R_{10}=22000 \text{ ohms}$, 0.5 watt
 $R_{11}=2000 \text{ ohms}$, 2 watts
 $R_{12}, R_{13}=0.1 \text{ megohm}$, 0.5 watt
 $R_{14}, R_{15}=1000 \text{ ohms}$, 0.5 watt
 $R_{16}, R_{17}=56 \text{ ohms}$, 0.5 watt
 $R_{18}=270 \text{ ohms}$, 0.5 watt
 R_{19} =Hum balance adjuster, potentiometer, 100 ohms, 0.5 watt
 $R_{20}=220 \text{ ohms}$, 10 watts

$R_{21}=50 \text{ ohms}$, 10 watts
 $R_{22}=10000 \text{ ohms}$, 2 watts
 T_1 =Output transformer (having 16-ohm tap for feedback connection) for matching impedance of voice coil to 6600-ohm plate-to-plate tube load; 50 watts; frequency response, 10 to 50000 Hz; Stancor A-8056 or equiv.
 T_2 =Power transformer, 375-0-375 volts rms, 160 mA; 6.3 V., 5 A; 5 V., 3 A; Thordarson type T22R33 or equivalent (see Note 1).

Notes: 1. For stereo operation from a single power supply, the power transformer T_2 must be replaced by one that has a higher current rating. A Stancor Type 6315 or equivalent (370-0-370 volts rms, 275 mA) is recommended.

2. If amplifier oscillates or "motorboats," reverse ground and feedback connections in secondary of output transformer T_1 .

29-10 HIGH-FIDELITY AUDIO AMPLIFIER (Cont'd)

Circuit Description (Cont'd)

fier (circuit 29-9) except that it uses 7868 beam power tubes in the output stage to develop the higher audio power output and uses a resistive network in the negative leg of the power supply, rather than a separate

rectifier, to supply the fixed-bias voltage for the output stage. A potentiometer (R_{10}) connected across the 6.3-volt heater winding also provides the hum balance adjustment for the 30-watt amplifier.

29-11

HIGH-FIDELITY AUDIO AMPLIFIER

Class AB₁; Power Output, 50 Watts

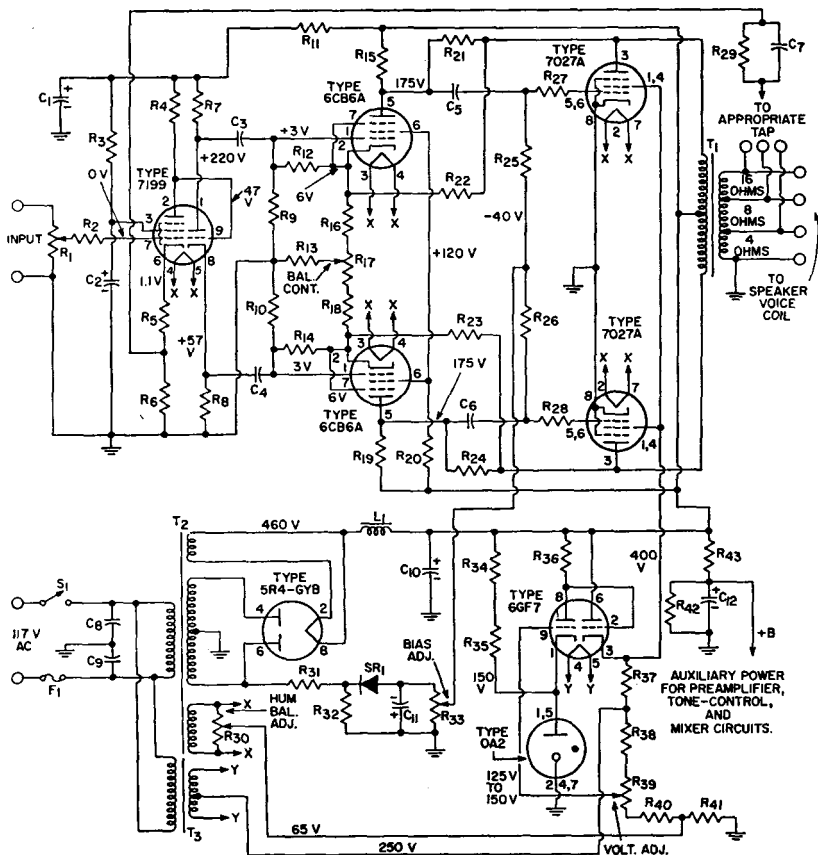

Preliminary Adjustments

The following adjustments should be made before operation:

- (1) With rectifier out of socket, adjust Bias Adj. R_{33} for -40 volts between the wiper arm and ground bus.
- (2) With speaker connected, adjust Screen-Grid Voltage Adj. R_{36} for 400 volts between pin 3 of 6GF7 and ground bus.
- (3) With input shorted, adjust Hum Bal. Adj. R_{30} for minimum hum from speaker.
- (4) With input open and Vol. set for maximum volume, adjust Bal. Cont. R_{17} for minimum hum from speaker.

29-11 HIGH-FIDELITY AUDIO AMPLIFIER (Cont'd)

Parts List

$C_1, C_2=40 \mu\text{F}$, electrolytic, 450 V	$R_{12}, R_{14}=1.3$ megohms, 0.5 watt	$R_{30}=0.27$ megohm, 0.5 watt
$C_3, C_4=0.02 \mu\text{F}$, paper, 400 V	$R_{13}=47$ ohms, 0.5 watt	$R_{31}=10000$ ohms, 1 watt
$C_5, C_6=1 \mu\text{F}$, paper, 400 V	$R_{15}, R_{16}=0.15$ megohm, 0.5 watt	R_{32} =Screen-grid voltage adjustment, potentiometer, 25000 ohms, 2 watts
$C_7=0.002 \mu\text{F}$ to 4-ohm tap; 0.0015 μF to 8-ohm tap; or, 0.001 μF to 16-ohm tap; paper, 400 V	$R_{16}, R_{18}=390$ ohms, 0.5 watt	$R_{40}=15000$ ohms, 2 watts
$C_8, C_9=0.05 \mu\text{F}$, paper, 600 V	R_{17} =AC balance control, potentiometer, 500 ohms	$R_{41}=12000$ ohms, 2 watts
$C_{10}=20 \mu\text{F}$, electrolytic, 450 V	$R_{20}=0.15$ megohm, 1 watt	$R_{42}=0.22$ megohm, 2 watts
$C_{11}=100 \mu\text{F}$, electrolytic, 150 V	$R_{21}, R_{24}=0.33$ megohm, 1 watt	$R_{43}=22000$ ohms, 2 watts
$C_{12}=40 \mu\text{F}$, electrolytic, 450 V	$R_{22}, R_{23}=0.12$ megohm, 2 watts	SR_1 =Selenium rectifier, 20 mA, 135 volts rms
F_1 =Fuse, 5 amperes	$R_{25}, R_{26}=0.1$ megohm, 0.5 watt	T_1 =Output transformer for matching impedance of voice coil to 5000-ohm plate-to-plate tube load; 50 watts; frequency response, 10 to 50000 Hz; United Transformer Corp. LS6L4 or equiv. (see Note 1)
L_1 =Choke, 8 H, 250 mA, dc resistance 60 ohms, or less	$R_{27}, R_{28}=4700$ ohms, 0.5 watt	T_2 =Power transformer, 600-0-600 volts rms, 200 mA, 6.3 V., 5 A.; 5 V., 3 A. Thordarson 2R36 or equiv. (see Note 2)
R_1 =Volume control, potentiometer, 0.5 megohm	$R_{29}=600$ ohms to 4-ohm tap; 820 ohms to 8-ohm tap; or, 1200 ohms to 16-ohm tap; 0.5 watt	T_3 =Filament transformer, 6.3 volts, center tapped, 1 ampere; Thordarson 21F08 or equiv.
$R_2=4700$ ohms, 0.5 watt	R_{30} =Hum balance adjustment, potentiometer, 100 ohms	
$R_3=0.82$ megohm, 0.5 watt	$R_{31}=0.12$ megohm, 5 watts	
$R_4=0.22$ megohm, 0.5 watt	$R_{32}, R_{34}, R_{35}, R_{37}=33000$ ohms, 2 watts	
$R_5=820$ ohms, 0.5 watt	R_{33} =Bias adjustment, potentiometer 50000 ohms,	
$R_6=10$ ohms, 0.5 watt		
$R_7, R_8=15000$ ohms, 2 watts		
$R_9, R_{10}=1.5$ megohms, 0.5 watt		
$R_{11}=33000$ ohms, 2 watts		

- Notes:**
- In many applications, less expensive transformers, such as Stancor Type A8053 or United Transformer Corporation Type S-17, which have a narrower frequency response, may be used for T_1 with satisfactory results.
 - For stereo operation from a single power supply, the following changes are required: (a) The power transformer T_2 must be replaced by one that has a higher current rating; a Freed Transformer Corporation Type DC6A or equivalent (600-0-600 volts rms, 300 mA) is recommended. (b) The 50000-ohm Bias Adj. potentiometer R_{33} should be replaced by two 100000-ohm potentiometers (one for each channel) connected in parallel. (c) A second 5R4-GYB rectifier tube should be connected in parallel with the one used for monaural operation. (Connect the 5R4-GYB tubes so that the two sections of each tube are in parallel with the corresponding sections of the other tube; do not use separate tubes for each section of the rectifier circuit.)
 - If the amplifier oscillates or "motorboats," reverse ground and feedback connections in secondary of output transformer T_1 .

Circuit Description

This four-stage audio power amplifier can deliver 50 watts of rms power output with less than 0.1 per cent total harmonic distortion and less than 1 per cent intermodulation distortion. The frequency response of the amplifier is flat within ± 0.5 dB from 10 Hz to 50 kHz. Sensitivity is 0.4 volt rms input for 50 watts output. The total hum and noise is 70 dB below 50 watts.

The 50-watt amplifier, like the 15-watt and 30-watt high-fidelity amplifiers (circuits 29-9 and 29-10), uses a 7199 low-noise triode-pentode as an input amplifier and phase-splitter, but has a push-pull driver stage, which uses 6CB6 sharp-cutoff pentodes. The superior performance of this amplifier can also be attributed, in part, to the use of a 450-volt plate supply and a 400-volt electron-ically regulated grid-No. 2 supply

for the 7027A beam power tubes in the output stage and to the use of inverse-feedback loops from the plates to the grids of the output tubes, from the plates of the output tubes to the cathodes of the driver tubes, and from the voice-coil winding of the output transformer to the cathode of the input amplifier. Additional features are the operation of all heaters at a positive voltage with respect to ground and use of a balancing adjustment (R_{30}) in the heater-supply circuit to minimize hum, a grid-No. 2 voltage adjustment (R_{32}), a grid-No. 1 bias adjustment (R_{33}) for the 7027A output tubes, and an ac-balance adjustment (R_{13}) which may be used to balance the outputs of the push-pull stages. Operation of the 50-watt amplifier is essentially the same as that of the 15- and 30-watt amplifiers.

29-12

TWO-CHANNEL STEREOPHONIC AMPLIFIER

Power Output, 1 Watt Each Channel

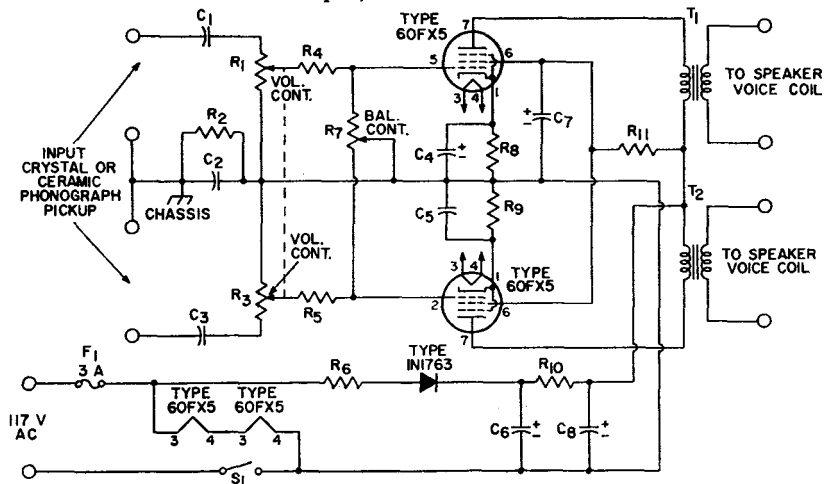

Parts List

$C_1, C_3 = 0.22 \mu\text{F}$, paper, 400 V

$C_2 = 0.1 \mu\text{F}$, paper, 400 V

$C_4, C_5 = 50 \mu\text{F}$, electrolytic, 25 V

$C_6 = 50 \mu\text{F}$, electrolytic, 150 V

$C_7, C_8 = 50 \mu\text{F}$, electrolytic, 150 V

$F_1 = \text{Fuse, 3 amperes}$

$R_1, R_2 = \text{Volume control potentiometer, 1.5 megohms, ganged, audio taper}$

$R_3 = 0.22 \text{ megohm, 0.5 watt}$

$R_4, R_5 = 47000 \text{ ohms, 0.5 watt}$

$R_6 = 12 \text{ ohms, 1 watt}$

$R_7 = \text{Balance control, potentiometer, 2 megohms, audio taper}$

$R_8, R_9 = 60 \text{ ohms, 1 watt}$

$R_{10} = 280 \text{ ohms, 2 watts}$

$R_{11} = 220 \text{ ohms, 2 watts}$

$S_1 = \text{ON-OFF switch, single-pole, single-throw}$

$T_1, T_2 = \text{Output transformer for matching impedance of voice coil to 3000-ohm tube load; Triad S-16X or equiv.}$

Circuit Description

This ac/dc two-channel (stereo) amplifier operates from either an ac power line or dc supply of 117 volts. AC power inputs are converted to dc power by the 1N1763 silicon-diode half-wave rectifier circuit. The heaters of the 60FX5 power pentodes (one for each channel) used in the amplifier are connected in series directly across the input power line.

In stereo units that use high-output ceramic stereo cartridges, the high power sensitivity of the 60FX5 tubes at low supply voltage eliminates the need for preamplifier stages. The 60FX5 provides a power output of 1.3 watts to a 3000-ohm transformer primary with only 3 volts peak drive on grid No. 1. With a transformer having a good impedance match and 85-per-cent efficiency, each channel of the stereo amplifier supplies 1.1 watts of useful power output at the speaker.

No special mounting or layout

precautions are necessary for this amplifier other than the value and placement of the isolating capacitor C_2 between B- and the chassis. This capacitor should be connected to the same point on the chassis at which the common cartridge lead is tied. A value of 0.1 microfarad for the isolating capacitor is suggested so that full output is obtained from the pickup.

As with all single-ended amplifier circuits, especially ac/dc units, adequate screen-grid bypassing is necessary to minimize hum. Screen-grid filtering is obtained through use of a 220-ohm dropping resistor R_{10} and a 50-microfarad electrolytic capacitor C_6 . Although, in the circuit shown, separate cathode-bias resistors are used for better dynamic balance, a single 30-ohm common cathode-bias resistor bypassed with a 50-microfarad electrolytic capacitor may also be used.

29-13 MICROPHONE AND PHONOGRAPH AMPLIFIER

Power Output, 8 Watts

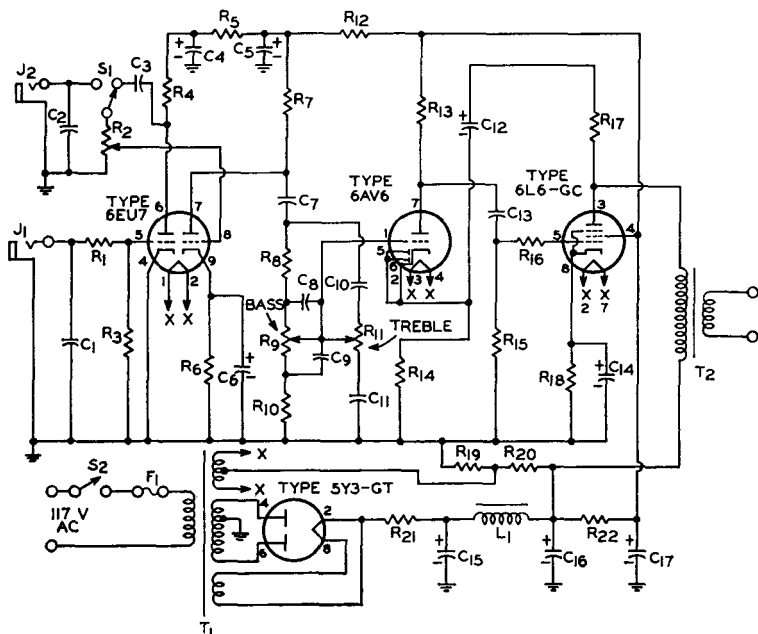

Parts List

$C_1, C_2=100$ pF, disc-ceramic, 300 V
 $C_3=0.05$ μ F, paper, 200 V
 $C_4=8$ μ F, electrolytic, 450 V
 $C_5=16$ μ F, electrolytic, 450 V
 $C_6=25$ μ F, electrolytic, 450 V
 $C_7=0.1$ μ F, paper, 200 V
 $C_8=0.001$ μ F, disc-ceramic, 300 V
 $C_9=0.01$ μ F, disc-ceramic, 300 V
 $C_{10}=470$ pF, disc-ceramic, 300 V
 $C_{11}=4700$ pF, disc-ceramic, 300 V
 $C_{12}=4$ μ F, electrolytic, 450 V
 $C_{13}=0.05$ μ F, paper, 600 V
 $C_{14}=25$ μ F, electrolytic, 25 V
 $C_{15}, C_{16}, C_{17}=20$ μ F, electrolytic, 450 V
 $F_1=$ Fuse, 1 ampere
 $J_1=$ Jack for high-impedance

crystal microphone input; max. input: 2 millivolts peak
 $J_2=$ Jack for crystal phonopickup input
 $L_1=$ Filter choke, 5 H, 200 mA, United Transformer Corp. R20 or equiv.
 $R_1, R_{10}=10000$ ohms, 0.5 watt
 $R_2=$ Volume Control, potentiometer, 1 megohm
 $R_3=2.2$ megohms, 0.5 watt
 $R_4, R_8, R_{20}=0.22$ megohm, 0.5 watt
 $R_5=27000$ ohms, 0.5 watt
 $R_6=1200$ ohms, 0.5 watt
 $R_7, R_{13}=0.1$ megohm, 0.5 watt
 $R_9, R_{11}=$ Tone control, potentiometer, 0.5 megohm
 $R_{10}=22000$ ohms, 0.5 watt
 $R_{12}=12000$ ohms, 0.5 watt

$R_{14}=1800$ ohms, 0.5 watt
 $R_{15}=0.47$ megohm, 0.5 watt
 $R_{17}=0.15$ megohm, 0.5 watt
 $R_{18}=180$ ohms, 2 watts
 $R_{19}=47000$ ohms, 1 watt
 $R_{21}=50$ ohms, 10 watts
 $R_{22}=8200$ ohms, 2 watts
 $S_1=$ Microphone-phonograph selector; wafer switch; single-pole, double-throw
 $S_2=$ ON-OFF switch, single-pole, single-throw
 $T_1=$ Power transformer, 300-0-300 V., 90 mA.; 6.3 V., 3.5 A., center tapped; 5 V., 2 A., Thordarson 22R04 or equiv.
 $T_2=$ Output transformer for matching impedance of voice coil to 4000-ohm tube load; 10 watts; United Transformer Corp. S14 or equiv.

Circuit Description

This microphone and phonograph amplifier can deliver up to 8 watts of audio output power for an input of 200 millivolts rms at J_2 (phonograph input) or an input of 6.8 millivolts rms at J_1 (microphone input). The amplifier uses a 6EU7 twin-triode input amplifier, a 6AV6 driver stage,

and a 6L6GC single-ended output stage to increase the signal power from a high-impedance crystal microphone or crystal phonograph pickup to the desired level. The transformer-coupled ac input power is converted to dc operating power for these stages by a 5Y3GT full-wave recti-

29-13

MICROPHONE AND PHONOGRAPH
AMPLIFIER (Cont'd)

Circuit Description (Cont'd)

fier circuit. A 5-volt winding on power transformer T_1 provides the heater power for the rectifier tube, and a 6.3-volt winding provides heater power for the other tubes in the amplifier. The center tap on the 6.3-volt winding is connected to the junction of a resistive voltage divider (R_{10} and R_{11}) across the output of the power supply. The resulting positive bias applied to the tube heaters substantially reduces heater-to-cathode leakage and, consequently, minimizes hum.

The signals from a crystal microphone are usually much smaller than those from a crystal phonograph pickup. Microphone signals, therefore, are amplified by both sections of the 6EU7 twin-triode amplifier. The signals are coupled from J_1 to the pin 5 control grid of the 6EU7. The plate output from this triode section is then coupled through switch S_1 (microphone position) and volume-control potentiometer R_2 to

the pin 8 control grid of the 6EU7. With selector switch S_1 in the phonograph position, phonograph inputs are coupled directly from J_2 across volume-control potentiometer R_2 to the pin 8 control grid, and the first section of the 6EU7 is bypassed.

The outputs from the pin 7 plate of the 6EU7 are coupled across the frequency-sensitive tone-control network to the control grid of the 6AV6 driver stage. The bass and treble controls R_9 and R_{11} are adjusted to assure optimum low- and high-frequency response characteristics for the amplifier. The two diode plate sections of the 6AV6 are shorted to the tube cathode and thereby are made inoperative. The output of the driver stage is applied to the 6L6GC output stage which develops the audio power required to drive a speaker. Transformer T_2 matches the 4000-ohm plate impedance of the output stage to the speaker voice-coil impedance.

29-14

TWO-CHANNEL AUDIO MIXER

Voltage Gain from Each Grid of 6EU7 to Output is Approximately 20

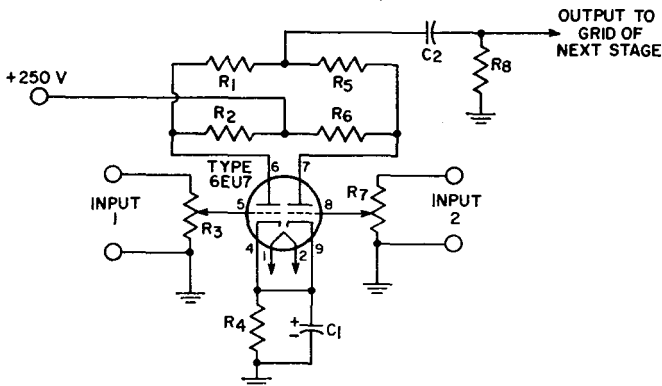

Parts List

$C_1=10 \mu\text{F}$, electrolytic, 25 V
 $C_2=0.05 \mu\text{F}$, paper, 400 V
 $R_1, R_5, R_6=1$ megohm,

0.5 watt
 $R_2, R_8=0.1$ megohm,
 0.5 watt

R_3, R_7 =Potentiometers, 0.1
 megohm, audio taper
 $R_1=1200$ ohms, 0.5 watt

29-16 PREAMPLIFIER FOR MAGNETIC PHONOGRAPH PICKUP

With RIAA Equalization

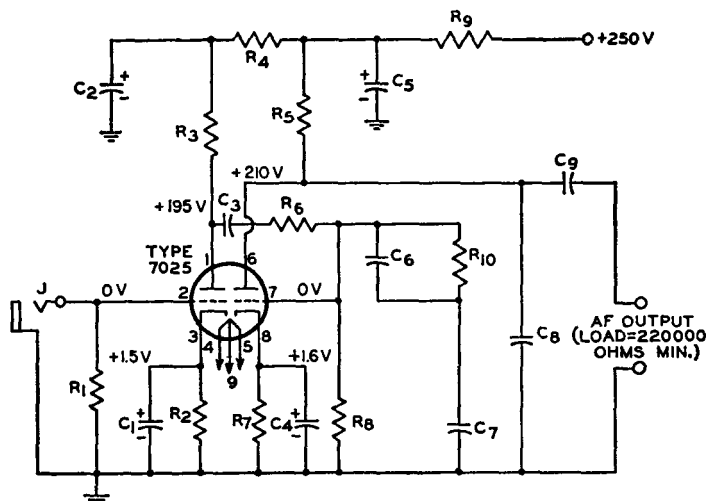

Sensitivity=3 millivolts rms input for output of 0.55 volt at frequency of 1000 Hz.

Parts List

C₁, C₄=25 μ F, electrolytic, 25 V

C₂, C₅=20 μ F, electrolytic, 450 V

C₃=0.1 μ F, paper, 600 V

C₆=0.0033 μ F \pm 5 per cent, paper, 600 V

C₇=0.01 μ F \pm 5 per cent, paper, 600 V

C₈=180 pF \pm 5 per cent, ceramic or mica, 500 V (includes capacitance of output cable)

C₉=0.22 μ F, ceramic, 500 V
J=Input connector, shielded, for high-impedance magnetic phono pickup (10 mV output, approx.)
R_i=Value depends on type

of magnetic pickup used. Follow pickup manufacturer's recommendations

R₂, R₇=2700 ohms, 0.5 watt
R₃, R₅=0.1 megohm, 0.5 watt
R₄=39000 ohms, 0.5 watt
R₆=0.47 megohm, 0.5 watt
R₈=0.68 megohm, 0.5 watt
R₉=15000 ohms, 1 watt
R₁₀=22000 ohms, 0.5 watt

Circuit Description

This two-stage audio preamplifier is intended for use with high-fidelity magnetic phonograph pickups. The two amplifier stages provide an overall circuit gain of approximately 150. The 7025 twin triode used in the circuit features exceptionally low hum and noise and is designed especially for use in high-fidelity circuits that operate at low signal levels. The preamplifier is ideally suited for use as the low-level input stage for audio power amplifiers such as the 50-watt unit, circuit 29-11. For use with audio power amplifiers such as the 15- and 30-watt units, circuits 29-9 and 29-10, which require higher input signals, another low-level amplifier (e.g., the tone-control amplifier, circuit 29-20) must be inserted between the preamplifier and the

power amplifier to obtain the full rated output. The heater and dc operating power required for the preamplifier can usually be obtained from the power-supply circuit for the power amplifier.

The audio signal from the phonograph pickup is applied to J and coupled through a length of shielded cable to the control grid of the input stage of the preamplifier. The inter-stage coupling between the two amplifier sections of the preamplifier includes an RIAA equalization network (R₁₀ and C₉). This network compensates for the Orthophonic recording characteristic* introduced into a record disc by the manufacturer. The output from the preamplifier is coupled from the plate of the second stage by output coupling capacitor

29-16

PREAMPLIFIER FOR MAGNETIC PHONOGRAPH PICKUP (Cont'd)

Circuit Description (Cont'd)

C_6 to the input of a tone-control amplifier (if used) or directly to the input of the power amplifier. Because of its relatively high output impedance, the preamplifier is recommended for use in systems in which the preamplifier is mounted on the same chassis as the power amplifier and/or tone-control amplifier. The preamplifier may be used at distances up to 6 feet from the following amplifier provided that the capacitance of capacitor C_6 is reduced approximately 30 picofarads for each foot of shielded cable used for the audio-frequency connection between the preamplifier and the following amplifier.

* To achieve wide frequency and dynamic ranges, manufacturers of commercial recordings use equipment which introduces a non-uniform relationship between amplitude and frequency. This relationship is known as a "recording characteristic." To assure proper reproduction of a high-fidelity recording, therefore, some part of the reproducing system must have a frequency-response characteristic which is the inverse of the recording characteristic. Most manufacturers of high-fidelity recordings use the RCA "New Orthophonic" (RIAA) characteristic for discs and the NARTB characteristic for magnetic tape.

29-17

HIGH-FIDELITY PREAMPLIFIER FOR TAPE-HEAD PICKUP With NARTB Equalization

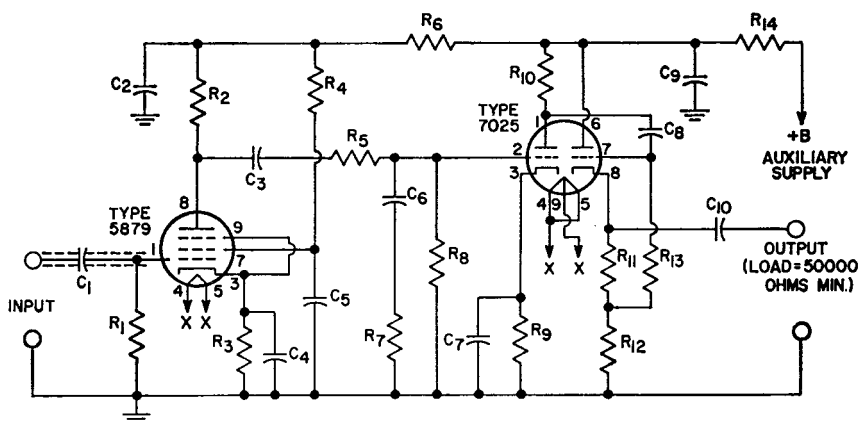

Sensitivity=3 millivolts rms input for output of 0.55 volt at frequency of 1000 Hz.

Parts List

$C_1=0.047 \mu\text{F}$, ceramic, 400 V

$C_2=40 \mu\text{F}$, electrolytic, 450 V

$C_3=0.1 \mu\text{F}$, ceramic, 400 V

$C_4=25 \mu\text{F}$, electrolytic, 25 V

$C_5=0.22 \mu\text{F}$, ceramic, 400 V

$C_6=0.015 \mu\text{F}$, ceramic, 400 V

$C_7=25 \mu\text{F}$, electrolytic, 25 V

$C_8=0.22 \mu\text{F}$, ceramic, 400 V

$C_9=40 \mu\text{F}$, electrolytic, 450 V

$C_{10}=0.47 \mu\text{F}$, ceramic, 400 V

$R_1=1 \text{ megohm}$, 0.5 watt

$R_2=0.1 \text{ megohm}$, 0.5 watt

$R_3=1000 \text{ ohms}$, 0.5 watt

$R_4=0.47 \text{ megohm}$, 0.5 watt

$R_5=0.22 \text{ megohm}$, 0.5 watt

$R_6=22000 \text{ ohms}$, 0.5 watt

$R_7=3300 \text{ ohms}$, 0.5 watt

$R_8=3.3 \text{ megohms}$, 0.5 watt

$R_9=1500 \text{ ohms}$, 0.5 watt

$R_{10}=0.1 \text{ megohm}$, 0.5 watt

$R_{11}=1500 \text{ ohms}$, 0.5 watt

$R_{12}=15000 \text{ ohms}$, 0.5 watt

$R_{13}=0.47 \text{ megohm}$, 0.5 watt

$R_{14}=4700 \text{ ohms}$, 0.5 watt

29-17

HIGH-FIDELITY PREAMPLIFIER FOR TAPE-HEAD PICKUP (Cont'd)

Circuit Description

This three-stage preamplifier provides the amplification necessary to increase the output from a tape-head pickup to the level required to drive an audio power amplifier. The circuit uses a 5879 low-noise sharp-cutoff pentode in a high-gain input voltage amplifier, one section of a 7025 twin triode in a second voltage amplifier, and the other section of the 7025 in a cathode-follower output stage. Because of the low-impedance cathode-follower output circuit, the preamplifier may be installed at distances up to 50 feet from the following stage (tone-control or power amplifier) without adverse effect upon its frequency-response characteristics. The preamplifier is intended for use as the low-level input stages for an audio power amplifier, such as the 50-watt unit (circuit 29-11) or, when followed by another low-level amplifier (e.g., the tone-control amplifier, circuit 29-20) the 15- or 30-watt unit (circuit 29-9 or 29-10).

The heater and dc operating power for the preamplifier can usually be obtained from the power supply for the power amplifier.

The preamplifier provides an over-all circuit gain of 180. An input of 3 millivolts rms at the input terminals, is amplified by the pentode and triode voltage amplifiers to develop an output of approximately 0.55 volt rms at the cathode of the cathode-follower output stage. The interstage coupling between the pentode and triode voltage amplifiers equalizes the playback frequency response of the preamplifier to compensate for the NARTB recording characteristic introduced into the magnetic tape by the manufacturer. (See footnote for circuit 29-16.) The output of the preamplifier is coupled by capacitor C_{10} to the input of the audio power amplifier or to the input of an intermediate tone-control amplifier.

29-18 PREAMPLIFIER FOR CERAMIC PHONOGRAPH PICKUP

Cathode Follower (Low-Impedance) Output

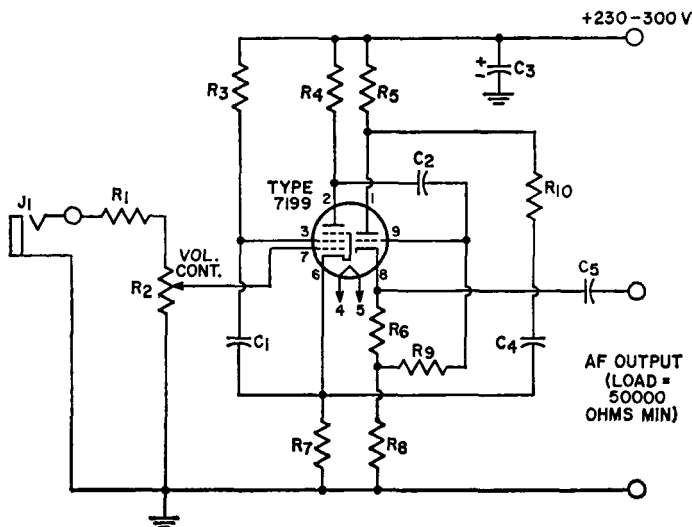

29-18

PREAMPLIFIER FOR CERAMIC PHONOGRAPH PICKUP (Cont'd)

Parts List

$C_1=0.1 \mu\text{F}$, paper, 400 V
 $C_2=0.01 \mu\text{F}$, paper, 400 V
 $C_3=20 \mu\text{F}$, electrolytic, 400 V
 $C_4=0.25 \mu\text{F}$, paper, 400 V
 $C_5=0.22 \mu\text{F}$, paper, 600 V
 J_1 =Input connector, shielded,

for high-impedance ceramic phono pickup (0.5-volt output)
 $R_1=1.8$ megohms, 0.5 watt
 R_2 =Volume control, potentiometer, 0.5 megohm, audio taper

$R_3=0.82$ megohm, 0.5 watt
 $R_4=0.22$ megohm, 0.5 watt
 $R_5, R_6=4,000$ ohms, 0.5 watt
 $R_6=4700$ ohms, 0.5 watt
 $R_7=1000$ ohms, 0.5 watt
 $R_8=1$ megohm, 0.5 watt
 $R_{10}=1800$ ohms, 0.5 watt

Circuit Description

This two-stage preamplifier is intended for use with a high-impedance ceramic phono pickup. The circuit features a cathode-follower (low-impedance) output which makes it possible to install the preamplifier at distances up to 50 feet from the succeeding stage (tone-control or power amplifier). The preamplifier operates from a dc supply of 230 to 300 volts and a heater supply of 6.3 volts. These voltages can usually be obtained from the power supply for the power amplifier in the audio system.

The preamplifier uses a 7199 triode-pentode in a high-gain pentode input stage and a triode cathode-follower output stage. These stages provide the amplification necessary to increase the output from a crystal phono pickup, applied at J_1 , to the level required to drive an audio power amplifier. The output of the preamplifier, coupled from the cathode of the 7199 triode section, may be applied directly to the power amplifier, or to an intermediate tone-control amplifier.

29-19

LOW-DISTORTION PREAMPLIFIER

For Low-Output, High-Impedance Microphones

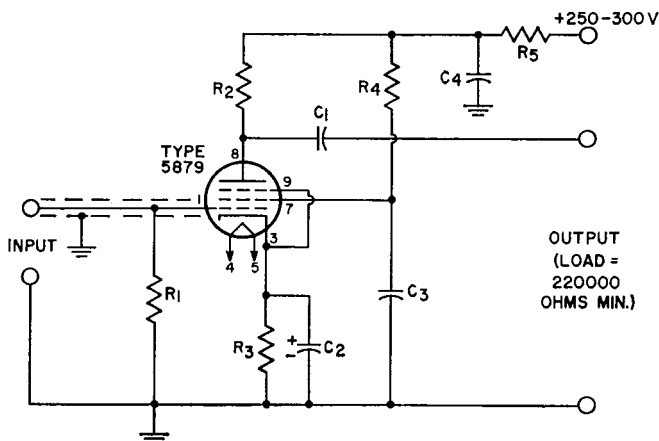

Sensitivity=3 millivolts rms input for output of 220 millivolts.

Parts List

$C_1=0.047 \mu\text{F}$, paper, 400 V
 $C_2=25 \mu\text{F}$, electrolytic, 25 V
 $C_3=0.22 \mu\text{F}$, paper, 400 V
 $C_4=40 \mu\text{F}$, electrolytic, 450 V

$R_1=2.2$ megohms, 0.5 watt
 $R_2=0.1$ megohm, 0.5 watt

$R_3=1000$ ohms, 0.5 watt
 $R_4=0.47$ megohm, 0.5 watt
 $R_5=22000$ ohms, 0.5 watt

29-19 LOW-DISTORTION PREAMPLIFIER (Cont'd)

Circuit Description

This single-stage preamplifier is intended for use with a high-fidelity, high-impedance crystal or dynamic microphone. The circuit uses a 5879 low-noise sharp-cutoff pentode in a conventional amplifier circuit that has a high-impedance output, a voltage gain of approximately 70, and a flat frequency response over the

audio range. Because of its high output impedance, the preamplifier should be mounted on the same chassis as the power amplifier and tone-control amplifier (if used). Heater and dc power for the circuit can be obtained from the power supply for the audio power amplifier.

29-20 BASS AND TREBLE TONE-CONTROL AMPLIFIER

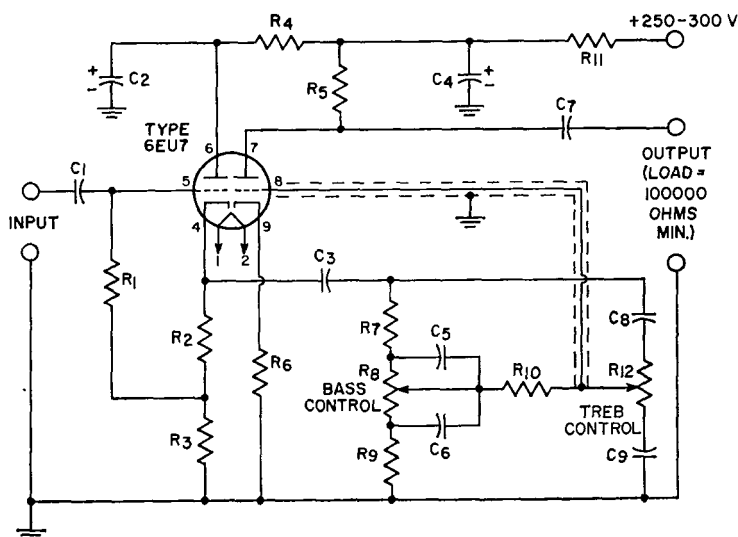

Sensitivity=0.5 volt rms input for output of 1.25 volts with controls set for flat response.

Parts List

$C_1=0.047 \mu\text{F}$, paper, 400 V
 $C_2, C_4=20 \mu\text{F}$, electrolytic, 450 V
 $C_3=0.1 \mu\text{F}$, paper, 400 V
 $C_5=0.0022 \mu\text{F}$, paper, 400 V
 $C_6=0.022 \mu\text{F}$, paper, 400 V
 $C_7=0.22 \mu\text{F}$, paper, 400 V
 $C_8=220 \text{ pF}$, ceramic or mica, 500 V

$C_9=0.0022 \mu\text{F}$, paper, 400 V
 $R_1=0.47 \text{ megohm}$, 0.5 watt
 $R_2=1500 \text{ ohms}$, 0.5 watt
 $R_3, R_{11}=15000 \text{ ohms}$, 0.5 watt
 $R_4=22000 \text{ ohms}$, 0.5 watt
 $R_5, R_7, R_{10}=0.1 \text{ megohm}$, 0.5 watt

$R_6=1000 \text{ ohms}$, 0.5 watt
 R_8 =Bass control, potentiometer, 1 megohm, audio taper
 $R_9=10000 \text{ ohms}$, 0.5 watt
 R_{12} =Treble control, potentiometer, 1 megohm, audio taper

Circuit Description

This high-fidelity tone-control amplifier uses a 6EU7 low-noise twin triode in a two-stage amplifier cascade that consists of an input cathode follower connected to a triode voltage amplifier through a frequency-sensitive (tone-control) interstage cou-

pling network. The bass and treble controls in the coupling network can be adjusted to provide up to 16 dB of boost or attenuation (cut) at 30 Hz and at 15 kHz. With the bass and treble controls set at the mid-range positions, the amplifier provides an

29-20 BASS AND TREBLE TONE-CONTROL AMPLIFIER (Cont'd)

Circuit Description (Cont'd)

over-all voltage gain of approximately 2.5, and its frequency response is flat within ± 1 dB from 30 Hz to 15 kHz.

The tone-control amplifier is designed for use immediately ahead of an audio power amplifier, such as the 15-, 30-, or 50-watt unit (circuit 29-9, 29-10, or 29-11, respectively). Operating power for the tone-control circuit can usually be obtained from the power supply for the power amplifier. For operating convenience,

the volume control on the power amplifier may be physically located on the tone-control chassis. In this case, it is advisable to insert a 1-megohm resistor in place of the volume control on the power amplifier. If partial compensation for the reduced high- and low-frequency sensitivity of the ear at low volume levels is desired, the volume-control potentiometer may be replaced by a loudness-control potentiometer.

29-21 ELECTRONIC VOLT-OHM METER

Circuit Description

This electronic volt-ohm meter can be used to measure rms values of ac sine-wave voltages from 0.1 to 1500 volts, dc voltages from 0.2 to 1500 volts, peak-to-peak voltages from 0.2 to 4000 volts, and resistances from 0.2 ohms to 1000 megohms. Within these over-all limits, a Range Selector (S_1) can be used to select seven different measurement ranges for each measurement function, as shown in the switch-position chart. The mode of operation of the volt-ohm meter is determined by the setting of the five-position (OFF, AC, -DC, +DC, and OHMS) Function Selector (S_2). A section (S_{2D}) of the Function Selector is also used to control the application of the 117-volt, 60-Hz, input ac power. The ac input power is converted to dc power by the 1N1764 selenium rectifier and associated components. A 6.3-volt secondary winding of power transformer T_1 supplies power to the tube heaters. A neon lamp connected across the primary of power transformer T_1 lights when ac power is applied to the circuit.

A balanced push-pull dc amplifier, which includes a dc microammeter M_1 connected as part of a dc bridge network between the two plate sections of the stage, is used as the basic measuring circuit for each measurement function of the volt-ohm meter. This circuit has a linear response, excellent stability, and a very high input impedance. Calibration adjustments are provided for each mode of operation to assure that accurate measurements are obtained. If desired, the ZERO ADJ potentiometer R_{20} may be adjusted to provide a center-scale zero reading on the meter, which is useful in discriminator and bias voltage measurements.

For ac voltage measurements, Function Selector S_2 must be rotated to the AC position. The ac voltage to be measured, applied between the AC-OHMS and COMMON terminals, is coupled through contacts 10 and 9 of S_{1A} to the ac-voltmeter multipliers (R_2 through R_4). The ac voltage from one of the taps on the multiplier, as determined by the setting of the

29-21

ELECTRONIC VOLT-OHM METER (Cont'd)

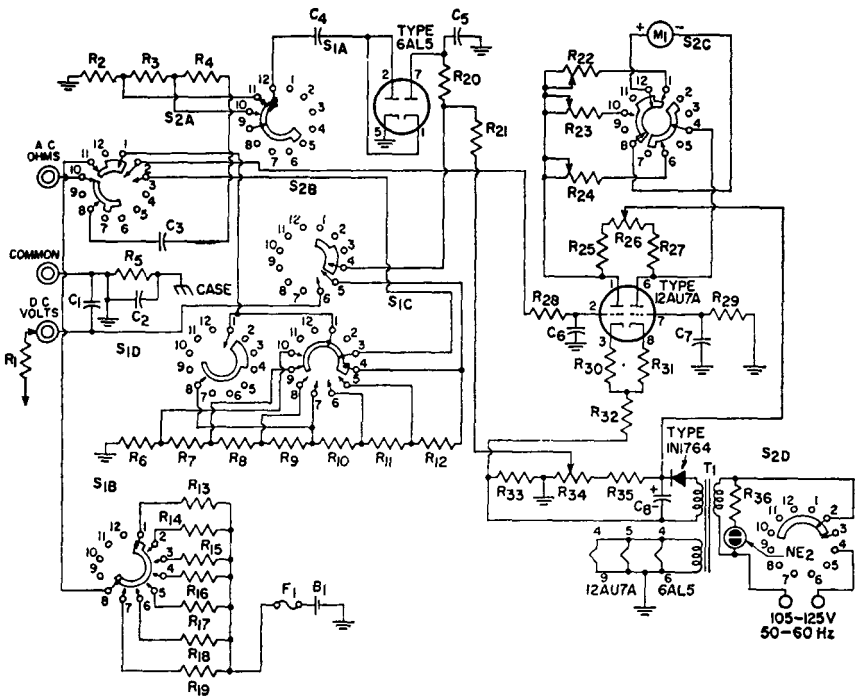

SWITCH POSITIONS

Position	Range Selector, S ₁		Function Selector, S ₂	
1	1.5V	Rx1	4V	OFF
2	5V	Rx10	14V	AC VOLT
3	15V	Rx100	40V	-DC VOLTS
4	50V	Rx1000	140V	+DC VOLTS
5	150V	Rx10,000	400V	OHMS
6	500V	Rx100,000	1400V	
7	1500V	Rx1M	4000V	

Notes: 1. Switches are shown in their maximum counterclockwise position (S₁=1.5 V, R X 1; S₂="OFF").

2. The accuracy of the volt-ohm meter depends upon the accuracy of the multiplier resistors.

Parts List

B₁=Battery, 1.5 V
 C₁=470 pF, ceramic disc, 1600 V
 C₂=0.001 μF, ceramic disc, 500 V
 C₃=0.47 μF, tubular, 400 V
 C₄, C₅=0.02 μF, ceramic disc, 400 V
 C₆, C₇=0.005 μF, ceramic disc, 200 V

C₈=10 μF, electrolytic, 400 V
 F₁=Fuse, 0.5 ampere
 M₁=Meter, dc, 0-200 μA
 NE₂=Neon lamp
 R₁=DC-voltage probe isolating resistor, 1 megohm, 0.25 watt
 R₂=138000 ohms, 0.25 watt
 R₃=320000 ohms, 0.5 watt

R₄=0.9 megohm, 1 watt
 R₅, R₁₈=1 megohm, 0.25 watt
 R₆, R₁₄, R₂₅, R₂₇=10000 ohms, 0.5 watt
 R₇=20000 ohms, 0.25 watt
 R₈=70000 ohms, 0.25 watt
 R₉=0.2 megohm, 0.25 watt
 R₁₀=0.7 megohm, 0.25 watt
 R₁₁=2 megohms, 0.25 watt

29-21 ELECTRONIC VOLT-OHM METER (Cont'd)

Parts List (Cont'd)

R_{12} —7 megohms, 0.25 watt	0.5 watt	0.5 watt
R_{13} —8.2 ohms, wire-wound, 0.5 watt	R_{21} —15000 ohms, potentiometer, ohms adjustment, 0.25 watt	R_{35} —47000 ohms, 0.5 watt
R_{14} —100 ohms, 0.25 watt	R_{26} —10000 ohms, potentiometer, zero adjustment, 0.25 watt	R_{36} —0.22 megohm, 0.5 watt
R_{15} —1000 ohms, 0.25 watt	R_{28} —3.3 megohms, 0.5 watt	S_1 —Range selector switch, 7 position, RCA stock No. 217924 or equiv.
R_{17} —0.1 megohm, 0.25 watt	R_{29} —6.8 megohms, 0.5 watt	S_2 —Function selector switch, 5 position, RCA stock No. 217923 or equiv.
R_{19} —10 megohms, 0.25 watt	R_{30} , R_{31} —330 ohms, 0.5 watt	T_1 —Power transformer, 105-125 volts rms. 50-60 Hz, RCA stock No. 217921 or equiv.
R_{20} —20 megohms, 0.25 watt	R_{32} —15000 ohms, 0.5 watt	
R_{21} —91 megohms, 0.5 watt	R_{33} —27000 ohms, 0.5 watt	
R_{22} —10000 ohms, potentiometer ac calibration, 0.5 watt	R_{34} —10000 ohms, potentiometer, ac balance,	
R_{23} —10000 ohms, potentiometer dc calibration,		

Circuit Description (Cont'd)

Range Selector (S_{1A} section), is rectified by the 6AL5 twin diode. The resultant dc voltage across the rectifier bleeder resistors R_{21} and R_{34} is proportional to the ac voltage from the multiplier network. This voltage is then coupled through contacts 4 and 5 of S_{2B} , through one of the contacts 4 through 10 (as determined by setting of Range Selector) and contact 1 of S_{1C} , and through contacts 1 and 2 of S_{2A} to the pin 2 control grid of the 12AU7A twin triode in the balanced dc amplifier. This input disturbs the balance of the amplifier and a current proportional to the ac input flows through the dc microammeter connected between the plates of the 12AU7. The pointer on the microammeter is then deflected to indicate the value of the voltage being measured.

With the Function Selector rotated to either $-DC$ or $+DC$, a dc voltage being measured is coupled through the 1-megohm probe R_1 , the DC VOLTS terminal, and contacts 6 and 5 of S_{2B} to the dc-voltmeter multipliers (R_6 through R_{12}). The 1-megohm resistance of the dc probe together with the resistance of the multipliers results in an input resistance of 11 megohms for dc voltage measurements. The dc voltage from the appropriate tap on the multiplier network selected by the S_{1C} and S_{1D} sections of the Range Selector is coupled through contact 1 of these switch sections (or contact

3 of S_{1C}) and contacts 1 (or 3) and 2 of S_{2A} to the input of the balanced dc amplifier. The pointer of the microammeter in the balanced amplifier is then deflected to provide an indication of the value of the dc voltage being measured. The S_{2C} section of the Function Selector reverses the connections of the microammeter when the Function Selector is rotated from $-DC$ to $+DC$ so that current will flow through the microammeter in the same direction regardless of whether a negative or positive dc voltage is being measured.

For resistance measurements, the Function Selector is rotated to the OHMS position, and the external resistance to be measured is connected between the AC-OHMS and COMMON terminals of the volt-ohm meter. A 1.5-volt dry cell then causes current to flow through the external resistance, through contacts 10 and 11 of S_{2A} , and through one of the ohmmeter-section multiplier resistors (R_{13} through R_{19}), as determined by the setting of the Range Selector (S_{1B} section). Because the multiplier resistance is fixed for each range, the voltage developed across the external resistance provides an accurate indication of the value of this resistance. This voltage is coupled through contacts 10 and 2 of S_{2A} to the input of the balanced dc amplifier. The pointer of the microammeter is then deflected to indicate the value of the resistance being measured.

29-23

ALL-PURPOSE DC POWER SUPPLIES

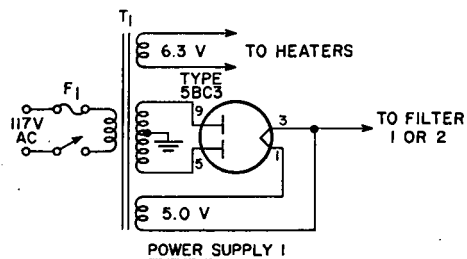

POWER SUPPLY 1

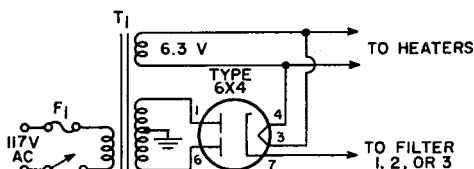

POWER SUPPLY 2

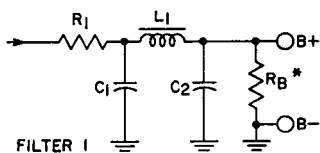

FILTER 1

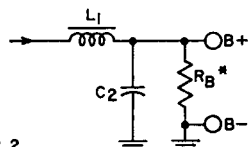

FILTER 2

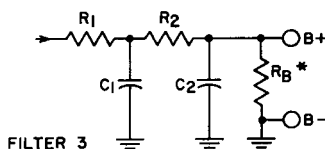

FILTER 3

POWER SUPPLY	TRANS-FORMER	CHOKE (L ₁)	R ₁	R ₂	C ₁ , C ₂	FIL-TER	OUTPUT VOLTS	MA
1 (5BC3)	Stancor PC or PM 8177 (300-0-300) or equiv.	140 mA, 7H, 165 ohms Stancor C1421 or equiv.	33 ohms 5W	—	40 μF 450 Vdc	1	360	60
							340	80
							320	120
2							235	60
							230	80
							215	120
1 (5BC3)	Stancor PC or PM 8412 (400-0-400) or equiv.	200mA, 4H, 145 ohms Thordarson 20C54 or equiv.	56 ohms 10W	—	40 μF 600 Vdc	1	450	120
							425	160
							410	200
2							310	120
							300	160
							280	200
2 (6X4)	Stancor P-6358 (300-0-300) or equiv.	80 mA, 12H, 375 ohms Thordarson 20C53 or equiv.	500 ohms 5W	500 ohms 3W	40 μF 450 Vdc	1	350	20
							300	40
							260	60
2							250	20
							230	40
							220	60
3							345	20
							300	40
							250	60
2 (6X4)	Stancor PM or PC 8419 (240-0-240) or equiv.	80 mA, 12H, 375 ohms Thordarson 20C53 or equiv.	500 ohms 5W	500 ohms 3W	40 μF 450 Vdc	1	265	20
							225	40
							190	60
2							200	20
							180	40
							170	60
3							260	20
							220	40
							180	60

* Bleeder R_B can be omitted if an external load is permanently connected across the output terminals. Bleeder current should be approximately 10 per cent of the load current.

29-23 ALL-PURPOSE DC POWER SUPPLIES (Cont'd)

Circuit Description

In these power-supply circuits, 5BC3 and 6X4 full-wave rectifier tubes are used to convert ac input power to dc output power in various combinations of output voltage and load current. The 5BC3 tube is a directly heated novar type intended for use in power supplies for radio equipment, television receivers, and other applications that have relatively high dc requirements. The 6X4 tube is an indirectly heated miniature type used primarily in power supplies for automobile and ac-operated radio receivers and other equipment that have moderate dc requirements.

In each rectifier circuit, the 117-volt ac input power is applied to the primary of a step-up power transformer T_1 . The two plate sections of the rectifier tube are connected to opposite ends of the center-tapped secondary winding of transformer T_1 . With respect to the grounded center tap, the voltage applied to each plate of the rectifier tube, therefore, is 180 degrees out of phase with that applied to the other plate. With an external load connected to the rectifier cathode, pulses of current flow alternately to one plate

and then to the other plate for each half cycle of the ac input power. This 120-Hz pulsating current develops a positive dc voltage across the load circuit.

Removal of virtually all the 120-Hz ripple component from the dc output can be accomplished by connection of a suitable filter network between the rectifier output (cathode) and the load circuit. Either Filter 1 or Filter 2 provides adequate filtering for the 5BC3 circuit. Any one of the three filter networks is satisfactory for use with the 6X4 circuit. Filter 3 is not recommended for use with the 5BC3 circuit because the use of the two resistors R_1 and R_2 in series with the relatively high output results in excessive power loss.

The chart shown with the rectifier circuits lists a wide range of dc output voltage obtainable for various values of load current. Proper selection of power transformer T_1 , of the type of filter network, and of the values of filter choke L_1 and resistors R_1 and R_2 results in the desired combination of output voltage and current.

BLACK-AND-WHITE TELEVISION RECEIVER

Circuits 29-24 through 29-28 are essentially identical to the corresponding circuits in the RCA-KCS-152 Television Receiver. These circuits comprise a complete intercarrier television receiver with the exception of the deflection coils and the picture tube. Portions of any television receiver, however, are required to operate over an extremely wide range of very high frequencies. The construction of such circuits requires more than ordinary skill and experience and the use of sophisticated test equipment (see general consideration for the construction of high-frequency and broadband circuits at the beginning of

this section). Home construction of such circuits is not recommended unless the builder has had considerable experience in this type of work.

The chassis of circuits 29-24 through 29-28 are connected to one side of the ac line during operation. Servicing of these circuits should not be attempted by persons not familiar with the following precautions necessary when working on this type of equipment:

1. An isolation transformer should be inserted between the receiver and the ac line before any servicing is attempted.

BLACK-AND-WHITE TELEVISION RECEIVER (Cont'd)

2. If the receiver must be operated directly from the ac supply, the power plug should be inserted in the proper direction to connect the chassis to the ground side of the ac line. An ac voltmeter should be used to measure

the voltage between the chassis and the power-source ground; no voltage reading should be obtained. If a reading is obtained, the power plug should be reversed and another check made for a zero reading.

29-24

VHF TUNER*For Black-and-White Television Receiver***Circuit Description**

This vhf tuner selects the desired vhf frequency channel, amplifies composite video signals in the frequency channel selected, and converts the signal frequencies to the 45.75-MHz picture intermediate frequency and the 41.25-MHz sound intermediate frequency used in television receivers. When used with a uhf tuner, the vhf tuner is operated as a two-stage broadband rf amplifier tuned to 44 MHz (center frequency of the if band) and is essentially a pre-if amplifier for the television receiver. In each mode of operation, the tuner has a band pass that is broad enough to pass all the video information (including synchronizing and equalizing pulses) and the sound information superimposed on the video and sound carrier frequencies and has sufficient selectivity to assure adequate adjacent-channel and image-frequency rejection. The +140 volts used as the B+ supply for the vhf tuner is obtained from the low-voltage power supply of the receiver. The heaters of the tubes in the circuit are connected in series with those of other tubes in the receiver, and power for the series heater string is obtained directly from the input ac power line.

The antenna used with the vhf tuner may be either a 75-ohm monopole, as used with portable receivers, or a balanced 300-ohm antenna. A balanced 300-ohm antenna system

can be matched to the unbalanced 75-ohm tuner input by means of the antenna-matching balun T₁. A 13-position channel selector, which consists of several wafer-switch sections (S₁ through S₁₃) mounted on a common shaft, establishes the operating frequency of the tuner for each of the vhf channels 2 through 13 or adapts the vhf tuner for operation with a uhf tuner. With S₁ set to any of the channel positions 2 through 13, the selected-channel signal from the vhf antenna is coupled through contacts U and 2 of S_{1B} and input transformer T₂ to the rf amplifier, and the input lead from the uhf tuner is not connected to the vhf circuit.

The vhf input signals are amplified by the 3GK5 high- μ frame-grid triode used in the rf amplifier stage. The S₃ section of the channel selector connects the appropriate combination of the inductors L₆ through L₁₅ into the grid circuit of the rf amplifier to tune this stage to the desired frequency channel. The agc bias voltage applied to the control grid of the 3GK5 triode automatically controls the gain of the rf stage. The bias voltage, which varies directly with the amplitude of the received signal, is derived by a keyed agc amplifier in the television receiver.

The output of the rf amplifier is coupled through a resonant impedance network to the control grid of

VHF TUNER (Cont'd)

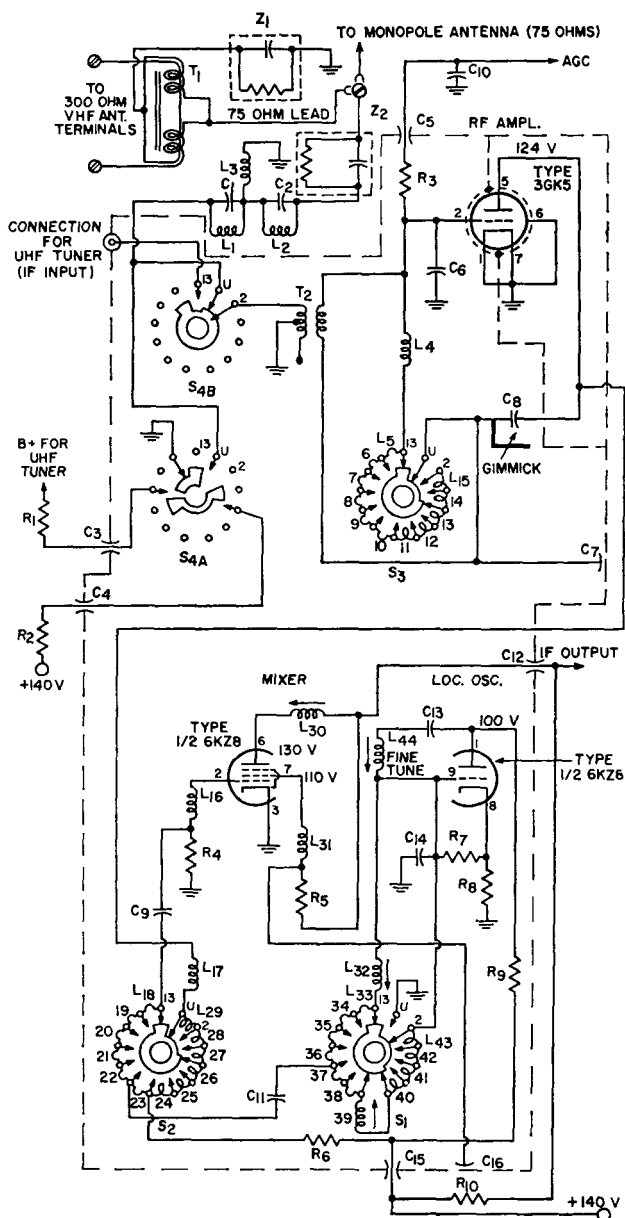

29-24

VHF TUNER (Cont'd)

Parts List

- $C_1, C_2=82$ pF, $\pm 5\%$, dual disc, ceramic, 500 V, N750
 $C_3, C_4, C_5, C_{15}, C_{16}=1000$ pF, feedthrough, 500 V
 $C_6=0.56$ pF, 5%, ceramic, 500 V, N750
 $C_7=20$ pF, $\pm 5\%$, feedthrough, 500 V, N470
 $C_8=0.56$ pF, $\pm 5\%$, headed lead, 500 V
 $C_9=100$ pF, ceramic, 500 V, N1500
 $C_{10}=0.22$ μ F, ceramic, 500 V
 $C_{11}=0.82$ pF, headed lead, 500 V
 $C_{12}=82$ pF, $\pm 5\%$, feedthrough, 500 V, N750
 $C_{13}=8$ pF, ceramic, 500 V
 $C_{14}=10$ pF, $\pm 5\%$, radial leads, ceramic, 500 V, N880
 GIMMICK=Trimmer-capacitor plate
 L_1, L_2, L_3 =RF coils; with two 82-picofarad capacitors, forms high-pass filter (antenna input network), RCA Stock No. 114458 or equiv.
 L_4 =RF amplifier grid coil, part of S_4 assembly
 L_5 through L_{15} =RF-amplifier tuning coils, part of S_3 assembly
 L_{16} =Mixer grid coil, part of S_2 assembly
 L_{17} =Interstage coupling coil for rf amplifier and mixer, part of S_2 assembly
 L_{18} through L_{20} =Mixer tuning coils, part of S_2 assembly
 L_{21} =Variable rf coil; mixer plate tuning adjustment; RCA stock No. 112909 or equiv.
 L_{22} =RF choke
 L_{23} =Variable rf coil; local-oscillator tuning adjustment for channel 13
 L_{24} through L_{25} =Local-oscillator tuning coils (variable coil L_{25} is tuning adjustment for channel 6), part of S_1 assembly
 L_{26} =Variable rf coil; fine-tuning control; RCA Stock No. 113323, or equiv.
 $R_1=4700$ ohms, 1 watt
 $R_2=5600$ ohms, 0.5 watt
 $R_3=47000$ ohms, 0.5 watt
 $R_4=0.1$ megohm, 0.5 watt
 $R_5, R_7=10000$ ohms, 0.5 watt
 $R_6, R_{10}=1000$ ohms, 0.5 watt
 $R_8=2200$ ohms, 0.5 watt
 $R_9=6800$ ohms, 0.5 watt
 S_1 =Local-oscillator section of channel-selector switch; stator assembly, RCA Stock No. 114462 or equiv., includes local-oscillator tuning coils L_{23} through L_{25}
 S_2 =Mixer section of channel-selector switch; stator assembly, RCA Stock No. 114461 or equiv., includes mixer tuning coils L_5, L_6 , and L_{18} through L_{20}
 S_3 =RF amplifier section of channel-selector switch; stator assembly, RCA Stock No. 114460 or equiv., includes rf-amplifier tuning coils L_4 and L_7 through L_{17}
 S_4 =VHF-UHF function selector; two-section switch ganged with channel selectors, S_1, S_2 , and S_3 ; RCA Stock No. 114185 or equiv.
 T_1 =Antenna-matching balun; matches 300-ohm balanced antenna-lead line to 75-ohm unbalanced receiver-input line; RCA Stock No. 111973 or equiv.
 T_2 =Antenna transformer; RCA Stock No. 113195 or equiv.
 Z_1, Z_2 =Resistance-capacitance network (capristor), RCA Stock No. 109956 or equiv.

- Notes: 1. All switches are ganged together on same shaft and are shown with shaft in channel 13 position.
 2. Voltages shown are obtained with no signal input.
 3. For dc voltage and heater supply, see circuit 29-28, page 725.
 4. See additional notes on page 712.

Circuit Description (Cont'd)

the 6KZ8 pentode section used in the mixer stage. Section S_2 of the ganged channel selector selects the proper combination of the inductors L_{18} through L_{20} to tune the mixer input circuit to the same operating frequency as that of the rf amplifier. A signal from the plate of the 6KZ8 triode section used in the local-oscillator stage is also applied to the input circuit of the mixer. Section S_1 of the channel selector connects the right combination of the inductors L_{23} through L_{25} into the oscillator resonant circuit to maintain the operating frequency of the oscillator at 45.75 MHz above the video carrier frequency (41.25 MHz above the sound carrier frequency) of the vhf channel selected by the tuner. Inductor L_{26} in the series-resonant feedback circuit of the oscillator is the fine-

tuning adjustment for the vhf tuner. This adjustment assures that the oscillator frequency accurately tracks the input tuning in each channel.

The signals from the rf amplifier and the local oscillator are heterodyned in the mixer stage to produce the 45.75-MHz amplitude-modulated and 41.25-MHz frequency-modulated difference frequencies used as the picture and sound intermediate frequencies, respectively, in the television receiver. The picture and sound if signals are coupled from the plate of the mixer to the if stages of the receiver.

When the multiple-section channel selector is rotated to the U position (for uhf operation), a connection from the B+ line of the vhf tuner through a 5600-ohm dropping resistor R_2 , contacts 4 and 10 of S_{4A} ,

29-24

VHF TUNER (Cont'd)

Circuit Description (Cont'd)

and a 4700-ohm dropping resistor R_1 provides the B^+ voltage for the uhf tuner. In addition, transformer T_2 , which provides the input to the rf amplifier, is connected through contacts 2 and 13 of S_{1B} to the output of the uhf tuner, and the signal from the vhf antenna is shorted to ground through contacts U and 12 of S_{1A} . The input to the rf amplifier is then the amplitude-modulated 45.75-MHz picture if and frequency-modulated 41.25-MHz sound if signals from the uhf tuner.

In the U positions, switch sec-

tions S_2 and S_3 select the tuning inductors required for operation of the rf amplifier and mixer stages as broadband 44-MHz amplifiers, and section S_1 disables the oscillator stage by connection of the oscillator control grid directly to ground through switch contacts 2 and U. With these changes, the vhf tuner essentially becomes a broadband 44-MHz amplifier which provides two stages of amplification of the picture and sound if signals ahead of the receiver main if strip.

29-25

VIDEO-IF AMPLIFIERS AND
SOUND-CHANNEL CIRCUITS

For Black-and-White Television Receiver

Circuit Description

These circuit stages are typical of those used in the if and audio channels of any intercarrier type of black-and-white television receiver. The over-all circuit operates from a dc supply of +150 volts obtained from the receiver low-voltage (B^+) dc power supply. The heaters of the tubes in the circuit are connected in series with those of tubes in other sections of the receiver. Operating power for the series heater string is obtained directly from the 117-volt ac power line.

The input from the vhf tuner consists of amplitude-modulated 45.75-MHz picture if signals and frequency-modulated 41.25-MHz sound if signals. This composite input is coupled by a broadly tuned bandpass filter network to the control grid of the 4JD6 remote-cutoff pentode used in the first picture if amplifier. A dc bias voltage proportional to the input signal from the agc amplifier is also applied to the control-grid circuit to provide automatic gain control of this stage. The output of the first picture if amplifier is coupled by the single-tuned transformer T_1 to the control grid of the 4JC6A pentode used in the second picture if amplifier. The double-tuned trans-

former T_2 couples the output of this stage to the video detector (CR_1 and associated components). The input filter network and picture if transformers T_1 and T_2 are stagger tuned to obtain the broad response for the if amplifiers required to assure adequate passage of both the 45.75-MHz video and 41.25-MHz sound if signals.

The video detector demodulates the 45.75-MHz picture if signal, and the resultant video signal is coupled through inductors L_5 and L_7 and the lower winding of transformer T_3 to the video amplifier (shown in circuit 29-27). The video detector also operates as a second mixer circuit. The 45.75-MHz picture if signal and the 41.25 sound if signal are heterodyned to produce a second sound if carrier of 4.5 MHz. This 4.5-MHz second sound if carrier is still frequency-modulated by the audio components contained in the original rf signal input at the receiver antenna. The sound-takeoff transformer T_3 , which forms a selective load impedance for the detector circuit at 4.5 MHz, couples the 4.5-MHz sound if signal to the control grid of the pentode section of a 6GH8A triode pentode used in the sound if ampli-

29-25

VIDEO-IF AMPLIFIERS AND SOUND-CHANNEL CIRCUITS (Cont'd)

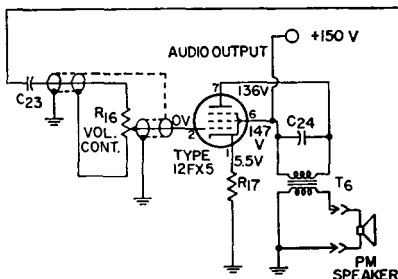
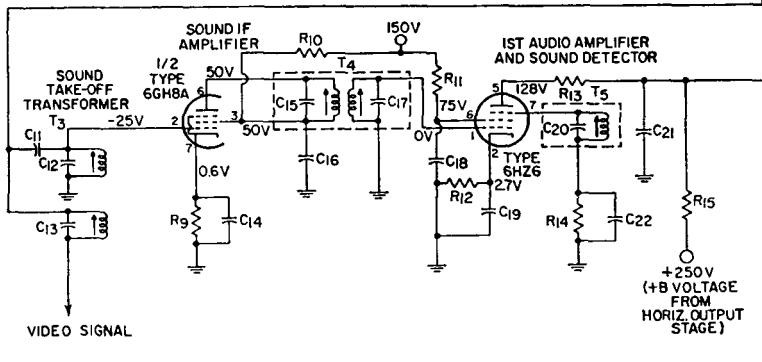
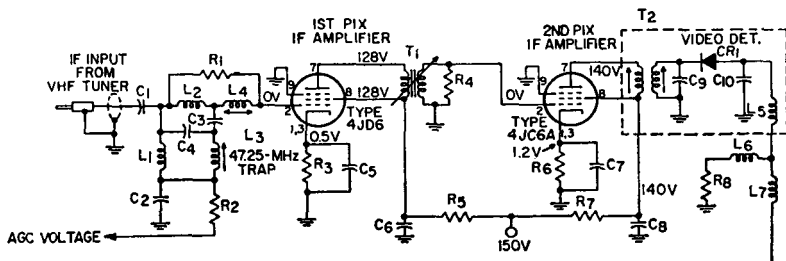

Parts List

C₁, **C₂**=470 pF, ceramic, 500 V
C₃, **C₇**=0.001 μF, ceramic 500 V
C₄=7 pF, ceramic, 500 V, N150
C₁=2 pF, ceramic, 500 V, NPO
C₆=18 pF, 5%, ceramic, 500 V, N220
C₅=56 pF, ±5%, ceramic, 500 V, N750
C₈=560 pF, ceramic, 500 V
C₉=18 pF, 5%, ceramic, 500 V, N220
C₁₀=6 pF, ceramic, 500 V
C₁₁=10 pF, ceramic, 500 V, NPO
C₁₂=39 pF, ceramic, 500 V, N150
C₁₃=68 pF, ceramic, 500 V, N750

C₁₄, **C₁₉**=0.01 μF, ceramic, 500 V
C₁₅, **C₁₇**=12 pF, part of T₁
C₁₆, **C₁₈**=0.0022 μF, ceramic, 500 V
C₂₀=10 pF, part of T₅
C₂₁=680 pF, ceramic, 500 V
C₂₂=0.047 μF, paper, 200 V
C₂₃=0.01 μF, ceramic, 500 V
C₂₄=0.0068 μF, ceramic, 500 V
CR1=Video detector, crystal diode, RCA Stock No. 112524 or equiv.
L₁=RF coil, RCA Stock No. 114315 or equiv.
L₂=RF coil, RCA Stock No. 114314 or equiv.
L₃=RF coil, 47.25-MHz trap

RCA Stock No. 113097 or equiv.
L₄=RF coil, RCA Stock No. 113097 or equiv.
L₅=Video-detector peaking coil, 36 μH, RCA Stock No. 109758 or equiv.
L₇=Filter choke (reactor), 2.7 μH, RCA Stock No. 107463 or equiv.
R₁=3300 ohms, 0.5 watt
R₂=1000 ohms, 0.5 watt
R₃=39 ohms, ±5%, 0.5 watt
R₄=4700 ohms, ±5%, 0.5 watt
R₅=1500 ohms, 1 watt
R₆=100 ohms, 0.5 watt
R₇=470 ohms, 0.5 watt
R₈=3000 ohms, ±5%, 0.5 watt

29-25

VIDEO-IF AMPLIFIERS AND SOUND-CHANNEL CIRCUITS (Cont'd)

Parts List (Cont'd)

R₈=820 ohms, 0.5 watt
R₁₀=82000 ohms, 0.5 watt
R₁₁=15000 ohms, 1 watt
R₁₂=560 ohms, 0.5 watt
R₁₃=470 ohms, 0.5 watt
R₁₄=0.47 megohm, 0.5 watt
R₁₅=0.39 megohm, 0.5 watt
R₁₆=Volume control, potentiometer, 1 megohm
R₁₇=180 ohms, 0.5 watt
T₁=First pix if transformer,

RCA Stock No. 109158
 or equiv.
T₂=Second pix if transformer, RCA Stock No. 114317 or equiv.
T₃=Sound take-off transformer, 4.5-MHz, RCA Stock No. 114489 or equiv.
T₄=Sound if transformer (includes primary and secondary capacitors),

RCA Stock No. 104137
 or equiv.
T₅=Sound detector resonant circuit (includes 10-pF capacitor), RCA Stock No. 109948 or equiv.
T₆=Audio output transformer, matches speaker voice-coil impedance to tube plate load, RCA Stock No. 114490 or equiv.

- Notes:** 1. Voltages shown are obtained with no signal input.
 2. For dc voltage and heater supply, see circuit 29-28, page 725.
 3. See additional notes on page 712.

Circuit Description (Cont'd)

fier. The amplified if signal from this stage is coupled by the double-tuned 4.5-MHz transformer **T₁** to the 6HZ6 audio detector-amplifier stage. This stage demodulates the 4.5-MHz sound if signal and amplifies the resultant audio signal voltage. The +250 volts used as the plate supply for the 6HZ6 is obtained from the horizontal output stage (shown in circuit 29-27 of the receiver.

The audio-signal power required

to drive the speaker is developed by a 12FX5 pentode used in a single-ended audio output stage. The audio-signal voltage from the plate of the audio detector-amplifier is amplified by the 12FX5 and coupled by transformer **T₆** to the voice coil of the speaker. The volume-control potentiometer **R₁₆** in the input circuit of the output stage provides manual adjustment of the sound level from the speaker.

29-26

VIDEO, AGC, AND SYNC AMPLIFIERS

For Black-and-White TV Receiver

Circuit Description

This circuit shows video, agc, and sync amplifiers for a black-and-white television receiver. The video and sync amplifiers operate from a plate supply (**B+**) voltage of 150 volts obtained from the receiver low-voltage power supply. The plate supply voltage for the agc amplifier is a positive keying pulse from the high-voltage transformer in the receiver. The heaters of the three tubes are connected in series with those of tubes in other sections of the receiver. Operating power for the series heater string is obtained directly from the ac power line.

In the video amplifier, the pentode section of an 11LQ8 triode-pentode provides the required amplification of the video signal. The video signal is coupled from the video detector to the control grid of the video amplifier. The output from the voltage divider in the plate cir-

cuit of this stage is applied to the cathode of the picture tube to intensity-modulate the electron beam during its vertical and horizontal scanning of the picture-tube screen. The contrast control adjusts both the amplitude of the video output and the dc potential at the cathode of the picture tube to control picture contrast. The voltage-divider network in the plate circuit of the video amplifier is interconnected with another voltage-divider network. This second network includes the brightness control and the width control in the screen-grid circuit of the receiver horizontal-output tube (shown in circuit 29-27. The brightness control adjusts the cathode bias on the picture tube to control the intensity of the screen display.

An output from the video amplifier is also applied to the control grid of the 11LQ8 triode section used

29-26 VIDEO, AGC, AND SYNC AMPLIFIERS (Cont'd)

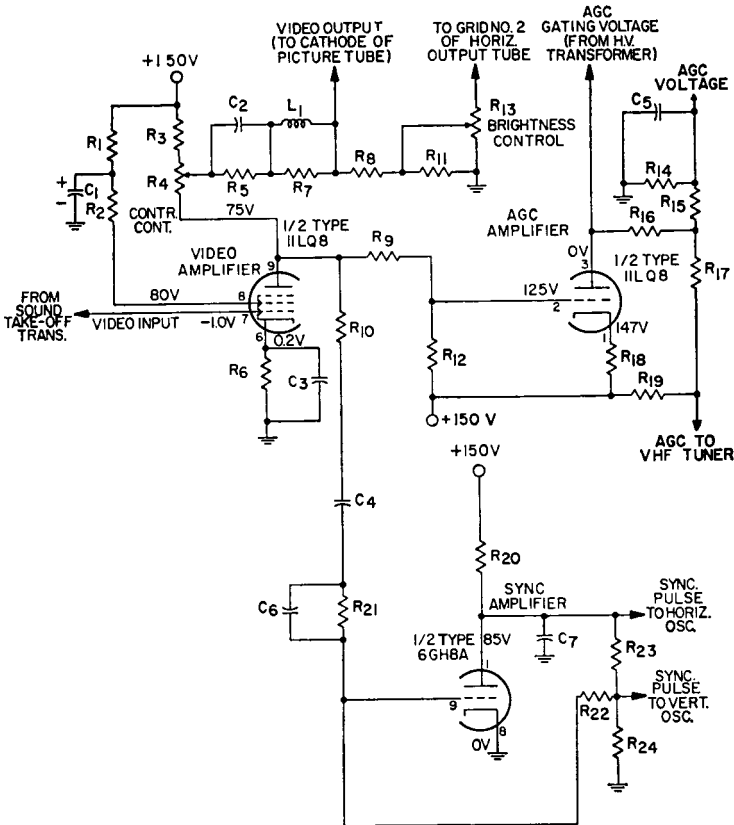

- Notes: 1. Voltages shown are obtained with no signal input.
 2. For dc voltage and heater supply, see circuit 29-28, page 725.
 3. See additional notes on page 712.

Parts List

C₁=5 μ F, electrolytic, 150 V
 C₂=0.15 μ F, paper, 200 V
 C₃=0.033, paper, 200 V
 C₄=0.0047, ceramic, 500 V
 C₅=0.1 μ F, paper, 200 V
 C₆=470 pF, ceramic, 500 V
 C₇=100 pF, ceramic, 500 V,
 N1500
 L₁=Video-amplifier peaking
 coil, 18 μ H, RCA Stock
 No. 109946 or equiv.
 R₁=18000 ohms, 0.5 watt

R₂=330 ohms, 0.5 watt
 R₃=1500 ohms, 0.5 watt
 R₄=Contrast control, poten-
 tiometer, 4000 ohms,
 3 watts
 R₅=1 megohm, 0.5 watt
 R₆=10 ohms, \pm 5%, 0.5 watt
 R₇=22000 ohms, 0.5 watt
 R₈=0.27 megohm, 0.5 watt
 R₉, R₁₀, R₂₀=27000 ohms,
 0.5 watt
 R₁₁=27000 ohms, 1 watt

R₁₂=18000 ohms, 0.5 watt
 R₁₃=Brightness control,
 potentiometer, 0.1 megohm
 R₁₄, R₁₇=0.82 megohm,
 0.5 watt
 R₁₅=1 megohm, 0.5 watt
 R₁₆, R₂₁=0.68 megohm,
 0.5 watt
 R₁₈=3300 ohms, 0.5 watt
 R₁₉=8.2 megohms, 0.5 watt
 R₂₂=5.2 megohms, 0.5 watt
 R₂₃=33000 ohms, 0.5 watt
 R₂₄=15000 ohms, 0.5 watt

Circuit Description (Cont'd)

in a keyed-agc amplifier stage. The operation of the agc amplifier is gated (keyed) by a positive pulse from the high-voltage power transformer (shown in circuit 29-27).

This 450-volt keying pulse, which is synchronized with the video signal, overcomes the bias provided by the 150 volts applied to the cathode circuit and serves as the plate supply

29-26 VIDEO, AGC, AND SYNC AMPLIFIERS (Cont'd)

Circuit Description (Cont'd)

voltage for the agc amplifier. Portions of the video signal that occur coincident with the keying pulse are amplified by the agc stage. A 0.1-microfarad capacitor C_5 and a 0.82-megohm resistor R_{14} in the plate circuit of this stage filter out the pulsating components to obtain a negative dc voltage proportional to the video signal and thus to the rf input at the receiver antenna. The negative voltage developed in the plate circuit of the stage is applied as agc bias to the first picture if amplifier and to the rf amplifier in the vhf tuner.

Synchronizing pulses are included in the video signals transmitted by a television broadcast station to provide timing information required for synchronization of the transmitter and receiver scanning systems. The sync amplifier, or separator, separates and amplifies the

synchronizing pulses contained in the composite video signal it receives from the plate circuit of the video amplifier. The circuit uses the triode section of a 6GH8A triode-pentode to develop the synchronizing pulses for the vertical- and horizontal-deflection circuits of the receiver. The sync amplifier is basically a class C limiter stage. With the video signal applied, the stage is biased beyond cutoff by the grid-leak bias network formed by the 470-picofarad capacitor C_6 and the 0.68-megohm resistor R_{21} in the control-grid circuit. Only the sync pulses in the composite video signal have sufficient amplitude to drive the sync amplifier into conduction. The resultant pulses developed across the output voltage-divider network are used as the synchronizing inputs to the horizontal- and vertical-deflection circuits.

29-27 VERTICAL- AND HORIZONTAL-DEFLECTION CIRCUITS AND HIGH-VOLTAGE RECTIFIER

For Black-and-White Television Receiver

Circuit Description

These circuits develop the vertical and horizontal scanning signals and the dc operating potentials for the picture tube (RCA Type 16BGP4) used in the black-and-white television receiver and the boosted B+ voltage (+250 volts) used in the audio detector-amplifier (part of circuit 29-26). The circuits operate from a dc supply of 150 volts. With the exception of the 1G3GT (or 1B3GT) high-voltage rectifier tube, the heaters of the various tubes are connected in series with those of tubes in other sections of the receiver and are supplied by the input ac power line. Heater power for the 1G3GT (or 1B3GT) is provided by a 1.25-volt winding of the high-voltage transformer T_1 .

The vertical- and horizontal-deflection circuits are synchronized by negative signals from the sync

amplifier (separator) which include horizontal sync pulses, equalizing pulses, and vertical sync pulses. When the composite video signal is generated at the television broadcast station, the leading edge of each horizontal sync pulse, of alternate equalizing pulses, and of alternate serrations of the vertical sync pulses are correctly timed to initiate the horizontal-retrace period. It is necessary, therefore, to extract the leading-edge components from the combined sync waveform prior to application of the synchronizing input to the horizontal-deflection circuit. Similarly, the vertical sync pulses must be separated from the combined waveform before they can be used to synchronize the vertical-deflection circuit.

The combined sync waveform is differentiated at the input to the

29-27 VERTICAL- AND HORIZONTAL-DEFLECTION CIRCUITS AND HIGH-VOLTAGE RECTIFIER (Cont'd)

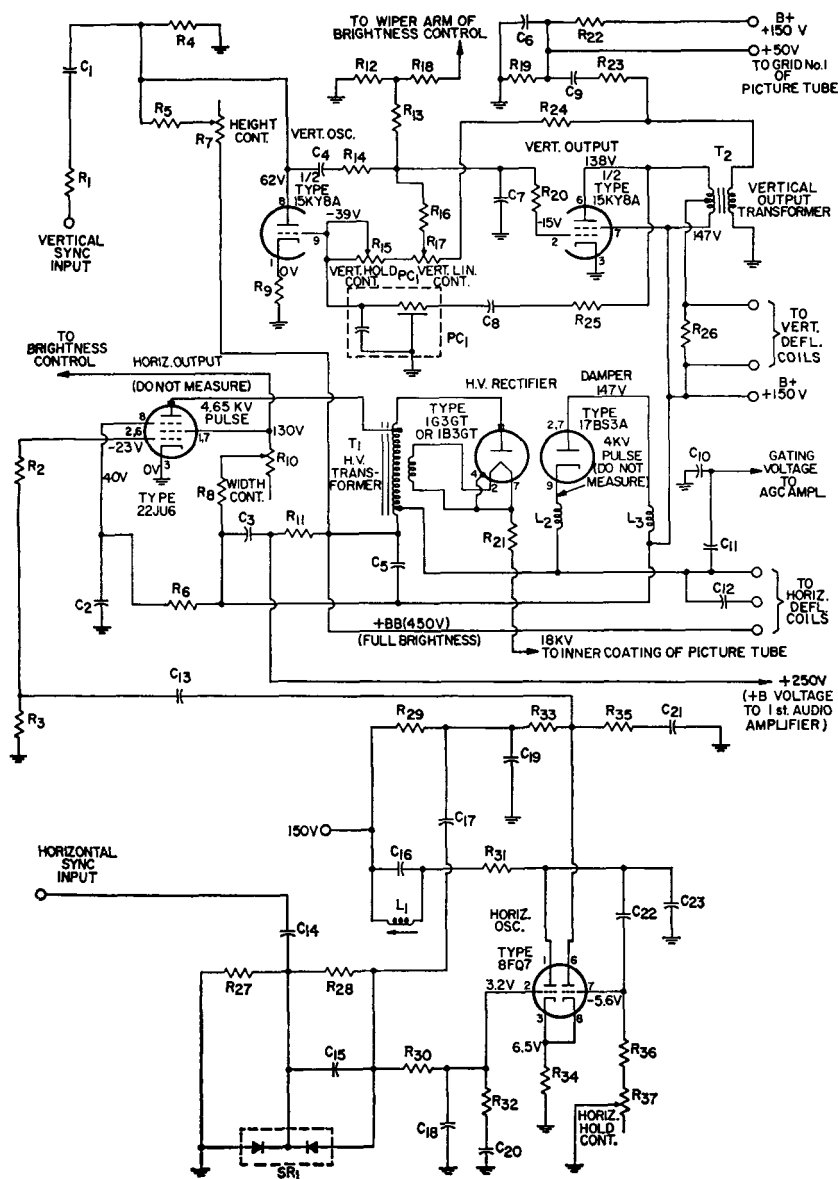

- Notes:**
1. Voltages shown are obtained with no signal input.
 2. For dc voltage and heater supply, see circuit 29-28, page 725.
 3. See additional notes on page 712.

29-27 VERTICAL- AND HORIZONTAL-DEFLECTION CIRCUITS AND HIGH-VOLTAGE RECTIFIER (Cont'd)

Parts List

$C_1=0.0039 \mu\text{F}$, ceramic, 500 V, N5600	NPO	control, potentiometer, 0.2 megohm
$C_2=0.01 \mu\text{F}$, ceramic, 500 V	I_{11} =Oscillator coil, RCA Stock No. 114486 or equiv.	$R_{18}=0.47$ megohm, 0.5 watt
$C_3, C_6=0.047 \mu\text{F}$, paper, 200 V	L_{21}, L_{22} =RF chokes (reactors), 8.2 μH , RCA Stock No. 107385 or equiv.	$R_{19}, R_{20}=27000$ ohms, 0.5 watt
$C_4=0.033 \mu\text{F}$, paper, 200 V	PC_1 =Printed circuit (includes 0.001- μF and 0.0024- μF capacitors and 68000-ohm resistor), RCA Stock No. 114506 or equiv.	$R_{21}=1000$ ohms, 0.5 watt
$C_5=0.027 \mu\text{F}$, paper, 600 V		$R_{22}=68000$ ohms, 0.5 watt
$C_8=0.015 \mu\text{F}$, tubular paper, 200 V	$R_1=0.1$ megohm, 0.5 watt	$R_{23}=10000$ ohms, 0.5 watt
$C_7=0.022 \mu\text{F}$, paper, 200 V	$R_2=47$ ohms, 0.5 watt	$R_{24}=0.18$ megohm, 0.5 watt
$C_8=0.0022 \mu\text{F}$, paper, 1000 V	$R_3, R_4=0.82$ megohm, 0.5 watt	$R_{25}=820$ ohms, 0.5 watt
$C_{10}=0.0012 \mu\text{F}$, $\pm 5\%$, ceramic, 500 V, N3300	$R_5=2.2$ megohms, 0.5 watt	$R_{27}=0.15$ megohm, 0.5 watt
$C_{11}=180$ pF, $\pm 5\%$, ceramic, 5000 V, N2200	$R_6=47000$ ohms, 0.5 watt	$R_{28}=0.39$ megohm, 0.5 watt
$C_{12}=47$ pF, ceramic, 2500 V, N1500	R_7 =Height control, potentiometer, 0.75 megohm	$R_{29}=12000$ ohms, 0.5 watt
$C_{13}=0.6033 \mu\text{F}$, ceramic, 500 V	$R_8=820$ ohms, 1 watt	$R_{30}=1$ megohm, 0.5 watt
$C_{14}=68$ pF, paper, 500 V, N1500	$R_9=3300$ ohms, 0.5 watt	$R_{31}=15000$ ohms, 0.5 watt
$C_{15}=470$ pF, ceramic, 500 V	R_{10} =Width control, potentiometer, 2000 ohms, 3 watts	$R_{32}=68000$ ohms, 0.5 watt
$C_{16}=0.0039 \mu\text{F}$, mylar, 400 V	$R_{11}=0.68$ megohm, 0.5 watt	$R_{33}=33000$ ohms, 0.5 watt
$C_{17}=0.001 \mu\text{F}$, ceramic, 500 V	$R_{12}=47000$ ohms, 0.5 watt	$R_{34}=1500$ ohms, $\pm 5\%$, 0.5 watt
$C_{18}=0.0033 \mu\text{F}$, ceramic, 500 V	$R_{13}=22$ megohms, 0.5 watt	$R_{35}=47000$ ohms, 0.5 watt
$C_{19}=0.001 \mu\text{F}$, ceramic, 500 V	$R_{14}=22000$ ohms, 0.5 watt	R_{37} =Horizontal-hold control, potentiometer, 70000 ohms.
$C_{20}=0.056 \mu\text{F}$, paper, 200 V	R_{15} =Vertical-hold control, potentiometer, 0.75 megohm	SR_1 =Selenium rectifier, RCA Stock No. 109474 or equiv.
$C_{21}=150$ pF, ceramic, 500 V	$R_{16}=1.8$ megohms, 0.5 watt	T_1 =High-voltage and horizontal-output transformer, RCA Stock No. 114498 or equiv.
$C_{22}=390$ pF, mica, 500	R_{17} =Vertical-linearity control, potentiometer, 0.2 megohm	T_2 =Vertical-output transformer, RCA Stock No. 114502 or equiv.
$C_{23}=68$ pF, ceramic, 500 V,		

Circuit Description (Cont'd)

horizontal-deflection circuit to obtain negative and positive voltage spikes which correspond to the leading and lagging edges, respectively, of the rectangular sync pulses. The amplitude of these voltage spikes is dependent upon only the peak value of the sync pulses and is not affected by the time durations of these pulses. The differentiating circuit, therefore, does not respond to the flat portions of the vertical sync pulses, and, with the exceptions of the serrations, the vertical sync pulses do not affect the operation of the horizontal-deflection circuits. The leading edge of alternate serrations, however, corresponds to the start of horizontal-retrace periods and thus may be considered as merely another horizontal sync signal.

The differentiated sync waveform is applied to the junction of the twin silicon diodes SR_1 , used in a phase-discriminator network. The positive portion of the differentiated waveform has no effect on the discriminator network. The negative

portion is compared with a feedback signal from the horizontal oscillator to derive the synchronizing voltage. The frequency of the horizontal oscillator and the repetition rate of the horizontal sync pulses should both be 15,750 Hz, the desired horizontal scanning rate for the picture tube. If the feedback signal from the oscillator does not occur coincident with the horizontal sync pulse, the phase discriminator develops a dc error voltage at the control grid of the input section of the 8FQ7 twin triode used in the oscillator stage. The resultant change in oscillator bias shifts the phase of the oscillator signal until it is locked in phase with the horizontal sync pulse.

The horizontal oscillator is basically a cathode-coupled multivibrator that free-runs, in asymmetrical half cycles, at a frequency of 15,750 Hz. A parallel LC circuit connected in series with the plate of the input section resonates at 15,750 Hz to provide frequency stabilization for the horizontal oscillator. The HOLD con-

29-27 VERTICAL- AND HORIZONTAL-DEFLECTION WIDTHS AND HIGH-VOLTAGE RECTIFIER (Cont'd)

Circuit Description (Cont'd)

Control adjusts the basic multivibrator frequency to achieve an exact lock-in with the horizontal sync pulses. In a cathode-coupled multivibrator, one amplifier section conducts at saturation and the other section is cut off during one half-cycle of operation, and these states are automatically reversed for the next half cycle. Such circuits normally provide rectangular-wave outputs from each plate section that are 180 degrees out of phase and that switch between the saturation plate voltage and B^+ (i.e., the cutoff plate voltage).

In the horizontal oscillator a series RC network is connected in parallel with the output tube section. Because of this network, the plate voltage does not immediately rise to the B^+ value when the output tube section is cut off. Instead, there is a small immediate rise in plate voltage that results from the voltage drop across the resistor R_{35} in the output RC network produced by the initial charging current to the capacitor C_{21} . The plate voltage then rises gradually at a rate determined by the long-time-constant circuit through which the capacitor is charged. Before the capacitor can fully charge to the B^+ voltage, the combination of the horizontal sync input and the feedback signal from the plate of the output section of the oscillator drives the grid of the input section below cutoff. The instantaneous rise in the plate voltage of the input section is coupled to the grid of the output section and causes this section to conduct. The capacitor C_{21} in the output RC network is then quickly discharged through the series resistor and the relatively low resistance of the output tube section. The output of the horizontal oscillator, therefore, is a trapezoidal voltage wave. The rising-slope portions of this wave (obtained when the output tube section is cut off)

corresponds to the horizontal-trace period on the picture tube; the discharge portion of the trapezoidal wave corresponds to the retrace period. The time-constant coupling circuits between the input and output sections of the oscillator are designed so that the retrace period represents only about 5 to 10 per cent of the over-all oscillator cycle.

The trapezoidal voltage wave is coupled to the control grid of the 22J6 pentode horizontal-output stage and causes a sawtooth current to flow through the high-voltage (flyback) transformer T_1 and through the horizontal-deflection coils of the picture tube. The gradually rising portion of the sawtooth current causes the horizontal scanning of the picture tube; the more rapid negative-slope portion of the current wave causes the retrace. During the retrace period, the picture-tube screen is blanked by a negative pulse applied to the control grid of the picture tube from the vertical-deflection circuits. The WIDTH control R_{10} in the screen grid of the horizontal-output stage adjusts the gain of this stage to control the width of horizontal scanning.

The vertical oscillator employs a 15KY8A triode-pentode in a basic plate-coupled multivibrator configuration. This free-running 60-Hz multivibrator is synchronized by the vertical sync pulses. The vertical pulses are separated from the combined sync waveform by integration of the combined waveform across the 0.022-microfarad capacitor C_7 in the control-grid circuit of the pentode output section of the multivibrator. The integrating network has negligible response for the narrow horizontal sync and equalizing pulses, but responds to the greater energy included in the much wider vertical sync pulses to develop a triangular voltage wave at the control grid of the pentode output section. The

29-27 VERTICAL- AND HORIZONTAL-DEFLECTION CIRCUITS AND HIGH-VOLTAGE RECTIFIER (Cont'd)

Circuit Description (Cont'd)

VERT LIN potentiometer R_{17} adjusts the charging period of the integrat- ing capacitor to control vertical linearity. The VERT HOLD potentiometer R_{18} adjusts the frequency of the multivibrator to achieve an exact lock-in with the vertical sync pulses.

The voltage waveform at the control grid of the pentode output section results in a triangular wave of current through the vertical-out- put transformer T_2 and through the vertical-deflection coils of the picture tube. The rising portion of the tri- angular current wave produces the vertical scanning, and the decreasing portion of the wave provides the retrace. Blanking pulses to cut off the picture tube during vertical and horizontal retrace periods are cou- pled from the secondary of T_2 and from the VERT LIN potentiometer (combined sync waveform before inte- gration) to the control grid of the picture tube.

The 1G3GT (or 1B3GT) half- wave rectifier circuit develops the dc operating voltages for the picture tube. The ac input power to the rectifier is supplied by the horizon- tal-deflection circuits. The sudden cutoff of plate current in the hori- zontal-output stage at the beginning of the retrace period causes a very large, positive-going voltage pulse

to be generated across the high- voltage transformer T_1 . The recti- fier converts this voltage pulse to a dc output voltage of approximately 18,000 volts, which is applied to the inner coating of the picture tube. Removal of negative overshoots that would be developed across the high- voltage transformer because of a flywheel effect is accomplished by connection of a 17BS3A rectifier (damper) tube across the horizontal- deflection coils which are in parallel with the lower tapped section of the high-voltage transformer. The polar- ity of the damper tube is such that the positive pulse developed across the high-voltage transformer causes no current flow through it. For nega- tive pulses, however, the damper tube provides a low-impedance path for the current, and energy stored in the horizontal-deflection coils dur- ing the preceding half-cycle is dis- sipated as heat at the damper-tube plate to prevent oscillation in the coils. The current through the damp- er tube develops a dc voltage of 450 volts across the 0.027-microfarad capacitor C_5 in the cathode circuit. The 0.68-megohm dropping resistor R_{11} re- duces this voltage to obtain the boosted B^+ of 250 volts required for operation of the audio detector-am- plifier (part of circuit 29-25).

29-28 LOW-VOLTAGE AND HEATER SUPPLY

For Black-and-White TV Receiver

Circuit Description

This circuit includes the low- voltage (+150-volt) dc power sup- ply and the series heater connec- tions for circuits 29-24 through 29- 27. As mentioned previously, the power supply and these four cir- cuits comprise a complete black-and- white television receiver, with the exception of the picture tube and the vertical- and horizontal-deflection yokes.

The power supply is a half-wave

type which uses a 1N3194 silicon rectifier. The 117-volt ac input is connected to the power supply through an interlock, S_1 , which may be mounted on the back cover of the receiver. AC input power is then automatically disconnected from the receiver when the back cover is removed. ON-OFF switch S_2 controls the application of ac power to the power-supply circuit and to the tube heaters. With S_1 and S_2 both closed,

29-28 LOW-VOLTAGE AND HEATER SUPPLY (Cont'd)

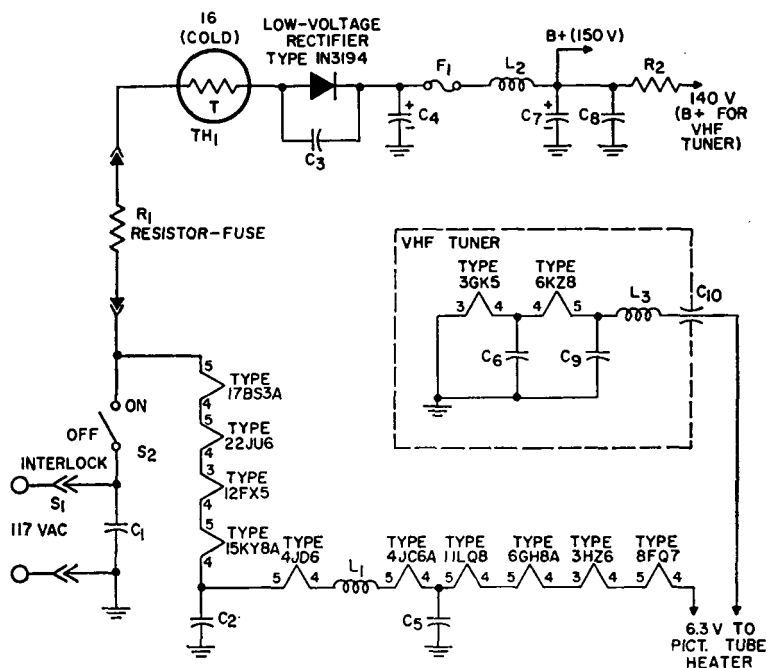

Parts List

$C_1=0.22 \mu\text{F}$, paper, 600 V
 $C_2, C_5=0.001$, ceramic, 500 V, part of assembly with L_1
 $C_3=680 \text{ pF}$, ceramic, 1000 V
 $C_4=250 \mu\text{F}$, electrolytic, 200 V
 $C_6, C_8=680 \text{ pF}$, ceramic, 500 V
 $C_7=400 \mu\text{F}$, electrolytic, 175 V
 $C_9=0.001 \mu\text{F}$, ceramic, 500 V
 $C_{10}=1000 \text{ pF}$, feedthrough, 5000 V

F_1 =Fuse, chemical, 0.45 ampere, RCA Stock No. 114446 or equiv.
 L_1 =RF choke, part of heater printed-circuit board, RCA Stock No. 114499 or equivalent (includes the two 0.001- μF capacitors C_2 and C_5)
 L_2 =Filter choke (reactor), RCA Stock No. 114501 or

equiv.
 L_3 =RF choke for VHF tuner filament circuit
 R_1 =Resistor-fuse, 0.35 ohm, RCA Stock No. 114481 or equiv.
 $R_2=330$ ohms, 1 watt
 TH_1 =Surge protection resistor (thermistor), 16 ohms (cold), RCA Stock No. 114480.

Circuit Description (Cont'd)

the 117-volt power from the ac power line is applied to the series heater network and to the 1N3194 rectifier circuit. Two 0.001-microfarad (C_2 and C_5) and two 680-picofarad (C_3 and C_6) bypass capacitors and rf chokes L_1 and L_2 are included in the heater circuit to filter out any stray high-frequency signals that may be coupled from the rf and if signal channels.

The 117-volt ac input is converted to pulsating dc by the 1N3194 silicon rectifier. A capacitor-input, pi-type LC filter network filters the

rectifier output to obtain a smooth dc voltage that approaches the peak value of the input ac voltage. The 680-picofarad capacitor C_6 in parallel with the 1N3194 rectifier and the thermistor TH_1 in series with it provide surge-current protection for the rectifier. Initial surges of current that may result when power is first applied to the circuit (before a charge is developed across the input filter capacitor) are partially bypassed by the 680-picofarad capacitor and are limited in magnitude by the cold resistance of the thermistor. The

29-28 LOW-VOLTAGE AND HEATER SUPPLY (Cont'd)

Circuit Description (Cont'd)

thermistor has a negative temperature coefficient of resistance, and by the time the charge of the input capacitor C_1 builds up sufficiently to limit the current through the rectifier to a safe value, the resistance of the heated thermistor is small enough so that circuit power losses across this device are negligible. The resistor-fuse element R_1 in series with

the 1N3194 rectifier provides protection against any continuous circuit overload. The +150-volt output from the power-supply filter network is used as the main B^+ voltage for the television receiver. The 330-ohm, 1-watt dropping resistor R_2 at the output of the filter network reduces this voltage to the +140 volts required as the B^+ voltage in the vhf tuner.

COLOR TELEVISION RECEIVER

Circuits 29-29 through 29-35 comprise a complete portable color television receiver. The brief signal-tracing analyses of these circuits assume that the reader has a basic knowledge of the purpose and operation of the various circuit sections of a color receiver. (The analyses can be more easily understood if the reader reviews the general discussions on television circuits given in the section on **Electron Tube Applications** starting on page 15). The receiver, which is essentially identical to the RCA Type CTC-22, features direct-line op-

eration; the chassis of circuits 29-29 through 29-35, therefore, are connected to one side of the ac line during operation. Servicing of these circuits should not be attempted by persons not familiar with the precautions necessary when working on this type of equipment. (See notes 1 and 2 on page 712.)

Note: Circuits 29-29 through 29-35 are included in this manual primarily to illustrate applications of RCA electron tubes. Because of the exceptionally high voltages (up to 21,500 volts), high frequencies, and large bandwidths that are required and of the many special components that are used, home construction of these circuits is not recommended.

29-29 LOW-VOLTAGE POWER SUPPLY, DEGAUSSING COIL, AND HEATER CONNECTIONS

For Color Television Receiver

Circuit Description

This circuit includes the low-voltage (+280-volt) dc power supply, degaussing circuitry, and heater connections for a color television receiver. The tube heaters, with the exception of the color picture tube, are connected in series across the ac power line. Heater power for the picture tube is supplied by transformer T_1 . With ON-OFF switch S_1 closed, the 117-volt power from the ac power line is applied to the series heater string and to the primary of transformer T_1 . The 117-volt ac input power is stepped down by transformer T_1 to 6.3 volts at 1.0 ampere and applied to the heater of the 15LP22 color picture tube. Bypass

capacitors and rf chokes are included in the series heater string to filter out any stray high-frequency signals that may be coupled from the rf and if signal channels of the receiver.

Two silicon rectifiers CR_1 and CR_2 are used in a voltage-doubler circuit to convert the 117-volt ac input power to the +280-volt B^+ supply voltage for the receiver. This doubler circuit also provides a 160-volt output from the junction of resistors R_1 and R_2 , a +140-volt output from the junction of resistor R_3 and capacitor C_1 , and a 95-volt output from the junction of resistor R_4 and capacitor C_{15} . The dc voltage outputs

29-29 LOW-VOLTAGE POWER SUPPLY, DEGAUSSING COIL, AND HEATER CONNECTIONS (Cont'd)

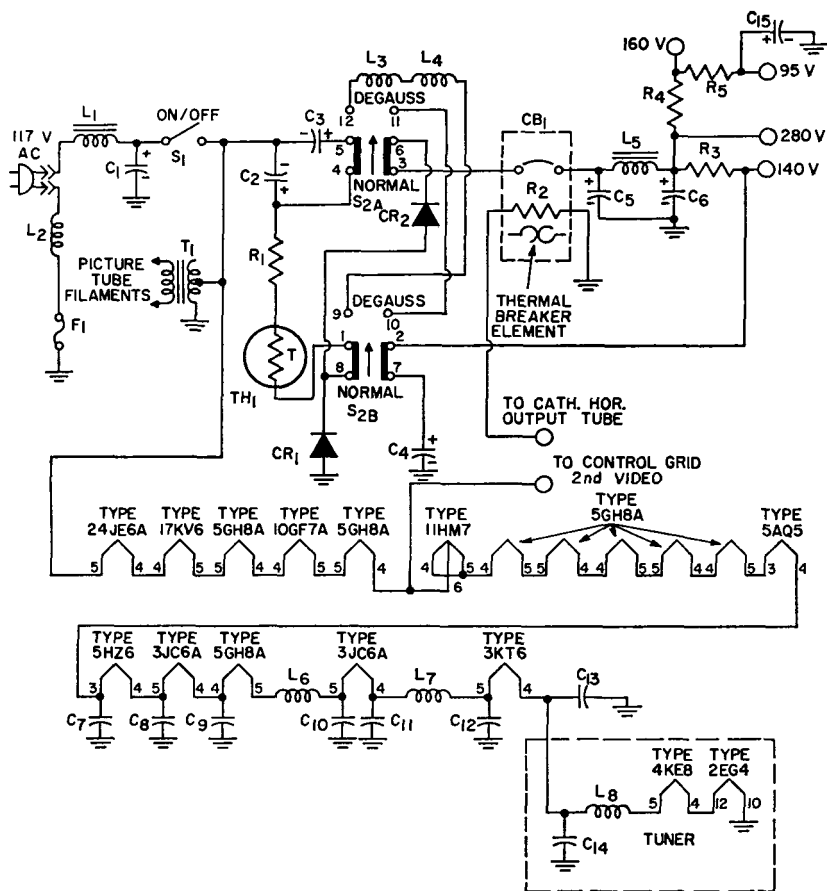

Parts List

$C_1=0.047 \mu\text{F}$, paper, 600 V
 $C_2=250 \mu\text{F}$, electrolytic, 175 V
 $C_3=50 \mu\text{F}$, electrolytic, 250 V
 $C_4=100 \mu\text{F}$, electrolytic, 300 V
 $C_5=150 \mu\text{F}$, electrolytic, 350 V
 $C_6=100 \mu\text{F}$, electrolytic, 350 V
 C_7 through $C_{11}=1000 \text{ pF}$, ceramic, 500 V
 $C_{12}=2 \mu\text{F}$, electrolytic, 175 V
 C_{13} =Circuit breaker (includes R_2), RCA Stock No. 120784 or equiv.
 CR_1, CR_2 =Silicon rectifiers, RCA Stock No. 113998 or

equiv.
 F_1 =Fuse, 7-ampere, 250-volt
 L_1, L_2 =Inductor, 60-Hz line filter
 L_3, L_4 =Degaussing coils, RCA Stock No. 120793 or equiv.
 L_5 =Filter choke, RCA Stock No. 120792 or equiv.
 L_6, L_7, L_8 =RF choke
 $R_1=2$ ohms, wirewound, 7 watts
 $R_2=1.3$ ohms, part of CB_1
 $R_3=3900$ ohms, wirewound,

10 watts
 $R_4=47000$ ohms, 1 watt
 $R_5=10000$ ohms, 7 watts
 S_1 =ON-OFF switch, single-pole, single-throw
 S_2 =Degaussing switch, RCA Stock No. 120829 or equiv.
 T_1 =Filament transformer; primary, 117-volt; secondary, 6.3-volt, 1-ampere
 TH_1 =Thermistor; cold resistance, 120 ohms

See Note on page 726.

29-29 LOW-VOLTAGE POWER SUPPLY, DEGAUSSING COIL, AND HEATER CONNECTIONS (Cont'd)

Circuit Description (Cont'd)

are filtered by the pi-section filter network formed by L_5 , C_5 , and C_6 .

The ac line is protected against any continuous circuit overload by a 7-ampere fuse, F_1 , connected in series with one side of the line to ground. Surge protection is provided by a thermistor TH_1 connected in series with the B+ rectifiers (CR_1 and CR_2). The B+ circuit is protected by a special thermal reset circuit breaker CB_1 . The circuit breaker opens the B+ line whenever the current demand on the low voltage power supply or the current through the horizontal output stage becomes excessive.

The circuit breaker has a resistive winding (approximately 1.3 ohms) that completes the ground return for the horizontal output tube. If the cathode current of the output tube becomes excessive, the resistive winding heats and causes the bi-metal strip in the circuit breaker to expand unequally. The resultant flexing of the bi-metal strip disconnects the breaker switch contacts and thereby opens the B+ line. The same action occurs when the B+ current demand becomes excessive.

Degaussing of the color receiver is initiated by depression of the spring-loaded switch S_2 to the DEGAUSS position. With S_2 in the NORMAL position, capacitors C_2 and C_3 are combined in parallel to provide the charging capacitance for the

voltage-doubler circuit. For this condition, the parallel capacitors C_2 and C_3 are charged to approximately 142 volts and capacitor C_1 is charged to 140 volts to provide the +280-volt B+ voltage. When S_2 is depressed to the DEGAUSS position, capacitor C_2 is disconnected from the circuit, and degaussing coils L_3 and L_4 are connected in series with the power-supply rectifiers and capacitor C_3 . When the line voltage swings positive, C_3 is charged through C_1 , degaussing coils L_3 and L_4 , and CR_2 ; when the line voltage is negative, C_3 is charged through CR_1 and the degaussing coils. This alternate cycling results in a symmetrical decaying wavetrain through the degaussing coils. The degaussing coils physically are looped about the receiver chassis in proximity to the color picture tube. The alternating magnetic fields developed by the decaying current wavetrain through these coils effectively demagnetizes the picture tube and adjacent chassis areas. The wavetrain decreases to zero when C_3 is charged to twice the peak value of the line voltage (approximately 330 volts dc). The degaussing action is completed in less than 1 second. It is only necessary, therefore, to momentarily depress switch S_2 to the DEGAUSS position. When the switch is released, it automatically returns to the NORMAL position.

29-30

VHF TUNER

For Color Television Receiver

Circuit Description

This vhf tuner operates from a dc voltage of +280 volts obtained from the low-voltage power supply in the color television receiver. The tuner employs a 2EG4 nuvistor triode in the rf amplifier stage and uses a 4KE8 triode-pentode for the os-

cillator and mixer stages. The heaters of these tubes are connected in series with those of other tubes in the receiver; power for the series-heater string is obtained directly from the 117-volt ac power line. This tuner is very similar to

VHF TUNER (Cont'd)

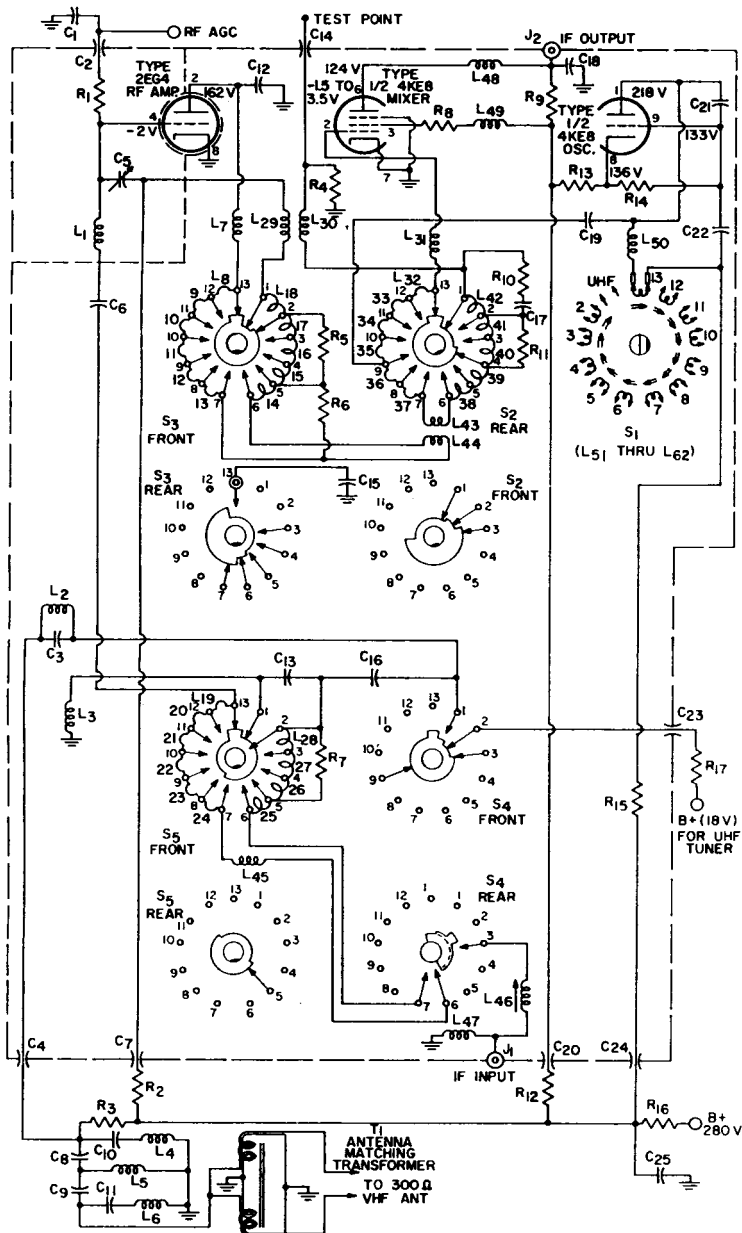

Note: Switches S1 through S5 are ganged together on the same shaft and are shown in channel 13 position.

29-30

VHF TUNER (Cont'd)

Parts List

- C₁=0.033 μ F, paper, 200 V
 C₂, C₂₀, C₂₂, C₂₄=1000 pF, feedthrough, 500 V
 C₃=47 pF \pm 5%, ceramic, 500 V, N750
 C₄=2 pF, feedthrough, RCA Stock No. 119595 or equiv.
 C₅=Trimmer, 2 to 10 pF, RCA Stock No. 112038 or equiv.
 C₆=27 pF \pm 5%, ceramic, 500 V, N750
 C₇=47 pF, feedthrough, 500 V
 C₈, C₉, C₁₀, C₁₁=27 pF \pm 5%, ceramic, 500 V, N470
 C₁₂=2.7 pF, headed lead, 500 V
 C₁₃=33 pF, ceramic, 500 V, N750
 C₁₄=39 pF, feedthrough, 500 V
 C₁₅=4.7 pF \pm 5%, headed lead, 500 V
 C₁₆=680 pF, ceramic, 500 V
 C₁₇=62 pF \pm 5%, ceramic, 1000 V, N1500
 C₁₈=27 pF, ceramic, 500 V
 C₁₉=2 pF, ceramic, 500 V, NPO
 C₂₁=5.6 pF \pm 5%, ceramic, 500 V, N150
 C₂₂=27 pF, ceramic, 500 V, NPO
 C₂₅=0.047 μ F, ceramic, 500 V
 L₁=RF amplifier grid coil, part of S₃ assembly
 L₂=UHF trap
 L₃=RF amplifier grid-circuit coil, part of S₅ assembly
 L₄, L₅, L₆=Filter coils for high-pass filter network, part of T₁ assembly
 L₇=RF amplifier plate coil, part of S₃ assembly
 L₈ through L₁₈=RF amplifier plate-circuit tuning coils, part of S₃ assembly
 L₁₉ through L₂₅=Antenna tuning coils, part of S₅ assembly
 L₂₆, L₃₀=High-band coupling adjust coils
 L₃₁=Mixer grid coil, part of S₂ assembly
 L₃₂ through L₄₂=Mixer tuning coils, part of S₂ assembly
 L₄₃, L₄₄=Low-band coupling adjust
 L₄₅=RF amplifier grid-circuit coil, part of S₅ assembly
 L₄₉=IF input coil for signals from uhf tuner, RCA Stock No. 120782 or equiv.
 L₄₇=RF coil, part of input circuit for signals from uhf tuner
 L₄₈=Mixer plate coil, RCA Stock No. 112909 or equiv.
 L₄₉=RF filter coil
 L₅₀=Channel 13 range-centering coil
 L₅₁ through L₆₂=Local-oscillator tuning coils, part of S₁ assembly
 J₁, J₂=Single-contact female connector, RCA Stock No. 104039 or equiv.
 R₁=47000 ohms, 0.5 watt
 R₂=16000 ohms, 3 watts
 R₃=4700 ohms, 1 watt
 R₄=82000 ohms, 0.5 watt
 R₅=1500 ohms, 0.5 watt
 R₆=10000 ohms, 0.5 watt
 R₇=2200 ohms, 0.5 watt
 R₈, R₁₀=10 ohms, 0.5 watt
 R₉, R₁₃=1000 ohms, 0.5 watt
 R₁₁=27000 ohms, 0.5 watt
 R₁₂=68000 ohms, 1 watt
 R₁₄=56000 ohms, 0.5 watt
 R₁₅=6800 ohms, 0.5 watt
 R₁₆=680 ohms, 1 watt
 S₁=Local-oscillator section of channel-selector switch; stator assembly, RCA Stock No. 114837 or equiv., includes local-oscillator tuning coils L₅₁ through L₆₂
 S₂=Mixer section of channel-selector switch; stator assembly, RCA Stock No. 120084 or equiv., includes mixer tuning coils L₃₁ through L₄₂
 S₃=RF amplifier section of channel-selector switch; stator assembly, RCA Stock No. 120086 or equiv., includes rf amplifier plate tuning coils L₇ through L₁₈
 S₄=UHF function switch assembly; part of channel-selector switch; stator assembly, RCA Stock No. 114807 or equiv.
 S₅=Antenna section of channel-selector switch; stator assembly, RCA Stock No. 120087 or equiv., includes antenna tuning coils L₁, L₄₉, and L₁₉ through L₂₅
 T₁=Antenna matching transformer (includes coils L₄, L₅, and L₆ in high-pass filter network), RCA Stock No. 113968

See Note on page 726.

Circuit Description (Cont'd)

the tuner for a black-and-white television receiver (shown in circuit 29-24), and it operates equally well for either color or black-and-white transmissions.

The antenna used with the tuner is a balanced 300-ohm dipole type which is matched to the unbalanced tuner input circuit by the antenna matching transformer T₁. The ganged 5-section, 13-position channel selector, S₁ through S₅, establishes the operating frequency of the tuner for each of the vhf channels 2 through 13 or adapts the vhf tuner for operation with a uhf tuner. When used with a uhf tuner, the vhf tuner is operated as a two stage broadband rf amplifier and becomes essentially a pre-if amplifier for the color television receiver.

With the channel selector set to any of the channel positions 2 through 13, telecast signals, either color or black-and-white, from the selected channel are coupled from the antenna circuit through sections S₄ and S₅ of the channel selector to the control grid of the 2EG4 rf amplifier. For channel positions 2 through 13, the input lead (IF INPUT) from the uhf tuner is not connected to the vhf tuner.

The vhf input signals are amplified by the rf amplifier. The S₃ and S₅ sections of the channel selector connect the appropriate combinations of inductors into the grid and plate circuits of the rf amplifier to tune this stage to the desired frequency channel. An agc bias voltage, derived from the keyed age amplifier

29-30

VHF TUNER (Cont'd)

Circuit Description (Cont'd)

in another section of the color receiver (circuit 29-32), is applied to the control grid of the 2EG4 to control the gain of the rf amplifier automatically.

The output of the rf amplifier is coupled through sections S_2 and S_3 of the channel selector to the control grid of the 4KE8 pentode section used in the mixer stage. Section S_4 of the ganged channel selector selects the proper combination of inductors to tune the mixer input circuit to the same operating frequency as that of the rf amplifier. A signal from the plate of the 4KE8 triode section used in the local-oscillator stage is also applied to the mixer. Section S_1 of the channel selector selects the required inductance so that the oscillator operates at a frequency 45.75 MHz above the video carrier frequency of the vhf channel selected by the tuner.

The signals from the rf amplifier and local oscillator are heterodyned in the mixer stage to produce the 45.75-MHz amplitude-modulated and 41.25-MHz frequency-modulated difference frequencies used as picture and sound intermediate frequencies, respectively. The composite color signal received at the antenna also includes a 3.58-MHz color subcarrier sideband. This subcarrier is also

heterodyned with the local-oscillator frequency to produce a color-subcarrier intermediate frequency of 42.17 MHz. The picture, color-subcarrier, and sound if signals are coupled from the plate of the mixer through J_2 to the if stages of the receiver.

When the multiple-section channel selector is rotated to the UHF position, S_2 disconnects the vhf antenna circuit from the rf amplifier, and section S_4 completes a connection to the 280-volt B+ line through several voltage-dropping resistors to provide a dc voltage output of 18 volts for use as the B+ voltage for a uhf tuner. The video, sound and color-subcarrier if signals from a uhf tuner can then be applied through the IF INPUT jack J_1 and contacts of S_4 and S_3 to the control grid of the 2EG4 rf amplifier.

With the channel selector in the UHF position, switch section S_1 opens the B+ line to the local oscillator to disable this stage. In addition, sections S_2 , S_3 , and S_4 select the proper combination of components so that the rf amplifier and mixer stages operate as broadband 44-MHz amplifiers to provide two stages of amplification of the picture and sound if signals ahead of the receiver main if strip.

29-31

VIDEO-AND SOUND-CHANNEL CIRCUITS

For Color Television Receiver

These circuits form the video and sound channels for a color television receiver. The circuits operate from a dc supply voltage of 280 volts, obtained from the receiver low-voltage power supply. The tube heaters are included in the series-heater string for the over-all receiver. Operating power for the series-heater string is obtained directly from the 117-volt ac power line.

The picture if-amplifier circuit

consists of two high-gain stages that use high-transconductance frame-grid tubes and double-tuned interstage coupling transformers. The composite if input from the vhf tuner which consists of amplitude-modulated 45.75-MHz picture signals 42.17-MHz color-subcarrier components, and frequency-modulated 41.25-MHz sound signals, are coupled by capacitor C_{21} and transformer T_1 to the control grid of the 3KT6 pentode used in the first picture if

29-31 VIDEO- AND SOUND-CHANNEL CIRCUITS (Cont'd)

Parts List (Cont'd)

- C_{27} =4700 pF, ceramic, 500 V
 C_{28} =430 pF $\pm 5\%$, mica, 500 V
 C_{30} =150 pF, mica, 500 V
 C_{31} =0.047 μ F, Mylar, 100 V
 C_{32} =0.047 μ F, ceramic, 100 V
 C_{33} =0.1 μ F, Mylar, 100 V
 C_{34} =560 pF, ceramic, 500 V
 C_{36} =680 pF, ceramic, 500 V
 C_{37} =220 pF, ceramic, 500 V
 C_{38} =50 μ F, electrolytic, 50 V
 CR_1 , CR_2 , CR_3 =1N60 diode
 CR_4 =Vertical-blanking diode, RCA Stock No. 115867 or equiv.
 DL_1 =Delay line, RCA Stock No. 120786 or equiv.
 L_1 =RF choke, 3.9 μ H, RCA Stock No. 116507 or equiv.
 L_2 , L_{10} =RF choke, 1.8 μ H, RCA Stock No. 109248 or equiv.
 L_3 =RF choke, 12 μ H, RCA Stock No. 120831
 L_4 =Inductor for 47.25-MHz trap, RCA Stock No. 121447 or equiv.
 L_5 =Video-detector filter coil, 5.6 μ H, RCA Stock No. 109171 or equiv.
 L_6 , L_8 =Part of 4.5-MHz trap, RCA Stock No. 121446 or equiv.
 L_7 =Video-detector filter coil, 36 μ H, RCA Stock No. 16056 or equiv.
 L_9 =RF choke, 100 μ H, RCA Stock No. 117380 or equiv.
 L_{11} =Filter coil, 27 μ H, RCA Stock No. 116511 or equiv.
 L_{12} =Filter network (includes resistor R_{22}); RCA Stock No. 116499 or equiv.
 L_{13} =Second-video plate coil, 330 μ H, RCA Stock No. 118710 or equiv.
 L_{14} =First-video plate coil, 1.8 μ H, RCA Stock No. 78466 or equiv.
 R_1 , R_6 , R_{25} =270 ohms, 0.5 watt
 R_2 , R_{25} =10000 ohms, 0.5 watt
 R_3 =8200 ohms, 0.5 watt
 R_4 =0.15 megohm, may be part of T_2
 R_5 =3300 ohms, 0.5 watt
 R_7 =0.68 megohm, 0.5 watt
 R_8 =0.47 megohm, 0.5 watt
 R_9 =68000 ohms, may be part of T_4
 R_{10} =Potentiometer, volume control, 1 megohm, 0.5 watt
 R_{11} =Potentiometer, sound-rejection adjustment, 7500 ohms, 0.5 watt
 R_{12} =3300 ohms, 0.5 watt
 R_{13} , R_{30} =0.1 megohm, 0.5 watt
 R_{14} =3900 ohms, $\pm 5\%$, 0.5 watt
 R_{15} =56 ohms, $\pm 5\%$, 0.5 watt
 R_{16} =1000 ohms, 0.5 watt
 R_{17} =22000 ohms, 4 watts
 R_{18} =6800 ohms, $\pm 5\%$, 0.5 watt
 R_{19} =150 ohms, $\pm 5\%$, 0.5 watt
 R_{20} =470 ohms, 0.5 watt
 R_{21} =1200 ohms, 0.5 watt
 R_{22} =4700 ohms, 0.5 watt
 R_{23} =0.18 megohm, 0.5 watt
 R_{24} =5.6 megohms, 0.5 watt
 R_{26} =22 megohms, 0.5 watt
 R_{27} =2.7 megohms, 0.5 watt
 R_{28} =Potentiometer, brightness control, 0.25 megohm, RCA Stock No. 120775 or equiv.
 R_{29} =680 ohms $\pm 5\%$, 0.5 watt
 R_{31} =0.22 megohm, 0.5 watt
 R_{32} =2200 ohms, part of assembly with L_{12}
 R_{33} =0.39 megohm, 0.5 watt
 R_{34} =0.12 megohm, 0.5 watt
 R_{36} =100 ohms, 0.5 watt
 R_{37} =5600 ohms, 0.5 watt
 R_{38} =560 ohms, 0.5 watt
 R_{39} =22000 ohms, 3 watts
 R_{40} =6800 ohms, 4 watts
 R_{41} =10000 ohms, 3 watts
 R_{42} =33000 ohms, 4 watts
 T_1 =Sound-takeoff transformer (includes C_1), RCA Stock No. 120824 or equiv.
 T_2 =4.5-MHz sound if transformer (includes C_7 and may include R_4), RCA Stock No. 120828 or equiv.
 T_3 =Pix if output transformer and 41.25-MHz trap, RCA Stock No. 120827 or equiv.
 T_4 =Sound-demodulator quadrature network (includes C_{13} and may include R_9), RCA Stock No. 120825 or equiv.
 T_5 =Audio output transformer, matches 5000-ohm tube-plate impedance to 3.2-ohm speaker voice coil, RCA Stock No. 120822 or equiv.
 T_6 =IF input transformer and 41.25-MHz trap, RCA Stock No. 116560 or equiv.
 T_7 =Pix if transformer, RCA Stock No. 120826 or equiv.
 See Note on page 726.

Circuit Description (Cont'd)

amplifier. The 3KT6 tube has good remote-cutoff characteristics, and the automatic-gain-control (agc) bias voltage from the receiver agc amplifier (shown in circuit 29-32) is also applied to the control-grid circuit of this tube. The output of the first picture if amplifier is coupled by transformer T_7 to the control grid of the 3JC6A pentode used in the second picture if amplifier. Capacitor C_6 couples the output of the second picture if amplifier to the sound detector, and transformer T_3 couples the output to the video (pix) detector. Transformers T_6 , T_7 , and T_3 are stagger-tuned to obtain the wide band pass required for the if amplifiers to pass both the 45.75-MHz video AM signals and the 41.25-MHz

sound FM signals, as well as the intermediate 42.17 color subcarrier.

The sound detector (CR_1 and associated components) is essentially a second mixer circuit. The 45.75-MHz picture if signal and the 41.25-MHz sound if signal are heterodyned to produce a second sound if carrier of 4.5 MHz. This 4.5-MHz sound if carrier is still frequency-modulated by the audio components contained in the original rf signal input at the receiver antenna. The sound-takeoff transformer T_1 forms a selective load impedance for the 4.5-MHz if signal derived in the sound detector circuit.

The 4.5 MHz signal developed across sound-takeoff transformer T_1 is applied to the control grid of the 3JC6A sound if amplifier. The ampli-

29-31 VIDEO- AND SOUND-CHANNEL CIRCUITS (Cont'd)

Circuit Description (Cont'd)

fied 4.5 MHz FM if signal from this stage is then coupled by the double-tuned transformer T_2 to the control grid of the 5HZ6 sound demodulator. This stage demodulates the 4.5-MHz sound if signal and amplifies the resultant audio signal voltage. The +490 volts used as the plate supply for the 5HZ6 demodulator tube is derived from the 700-volt B Boost supply in the horizontal-output stage (shown in circuit 29-33) of the receiver.

The tuned secondary circuit of transformer T_3 selects the 45.75-MHz amplitude-modulated picture and 42.17-MHz color sideband signals from the composite if signal and applies this picture signal to the video detector (CR_2 and associated components). The detected video signal developed across the detector-circuit filter network (L_5 , L_6 , L_7 , L_8 , and C_{30}) is then coupled through C_{31} and R_{23} to the control grid of the 5GH8A triode section used in the first video amplifier (the pentode section of the 5GH8A tube is used in the sync-agg-and-chroma driver, shown in circuit 29-32). The first video amplifier supplies the input signals to the sync-agg-and-chroma driver and to the second video amplifier.

The second video stage performs many functions. The input circuit of the 11HM7 pentode used in this stage is the insertion point for horizontal blanking pulses (for eventual application to the cathodes of the color picture tube). The horizontal blanking diode CR_3 is placed in the conducting mode by a small positive voltage applied to its anode through the dropping resistor R_{23} from the 280-volt B+ source. During active video scanning time, diode CR_3 is forward-biased (conducting), and the video signal is coupled by capacitor C_{31} to the control grid of the video amplifier. During horizontal blanking time, a negative pulse from the horizontal-output transformer

(T_1 in circuit 29-33) is applied through C_{31} and R_{23} to the diode. This negative pulse is sufficient to cut off the diode during horizontal retrace time. The pulse is applied to the control grid of the second video amplifier and drives the grid more negative (than would the normal horizontal sync pulse). The negative signal at the grid is inverted at the plate; the added positive level coupled to the cathodes of the color picture tube is sufficient to provide blanking of horizontal retrace lines.

The brightness control for the color receiver is also located in the control-grid circuit of the second video amplifier. Negative dc grid bias for the 11HM7 second video tube is derived from the ac voltage obtained from the heater, pin 6, of the second video tube. The 11HM7 heater is in the approximate center of the series heater string (refer to circuit 29-29); at this point, approximately 60 volts of ac voltage is available. The negative dc voltage (about -75 volts) is developed across C_{32} by the IN3194 rectifier circuit. Adjustment of the brightness control, R_{23} alters the grid bias by "tapping" the positive voltage applied to the top of the control. This unique circuit arrangement provides automatic brightness compensation with changes in power-line voltage. If line voltage increases, the negative voltage across C_{32} increases; the increased bias that is then applied to the 11HM7 decreases the conduction of this tube. The opposite action occurs with a decrease in line voltage.

The cathode of the second video amplifier is returned to the contrast control R_{11} . Brightness stability is obtained by use of a fixed 150-ohm, 5-per cent resistor, R_{13} , for dc cathode bias. Adjustment of the contrast control does not change the dc characteristics of the cathode; only the ac signal gain of the stage is altered when the control is adjusted.

29-31 VIDEO- AND SOUND-CHANNEL CIRCUITS (Cont'd)

Circuit Description (Cont'd)

Vertical-retrace blanking is accomplished in the plate circuit of the second video amplifier. During active scan periods, the vertical-blanking diode CR₁ is forward-biased (conducts); during vertical retrace periods, however, a positive (blanking) pulse from the vertical-output transformer (T₂ in circuit 29-33) is applied through R₃₃ to the cathode of the diode. This 60-volt positive

pulse is large enough to bias the diode into cutoff. During the blanking interval, the positive voltage pulse is added to the plate voltage of the 11HM7 second-video tube and applied to the cathode circuits of the color picture tube. As a result of the increased positive potential at the cathode, the picture tube is cut off during vertical retrace periods.

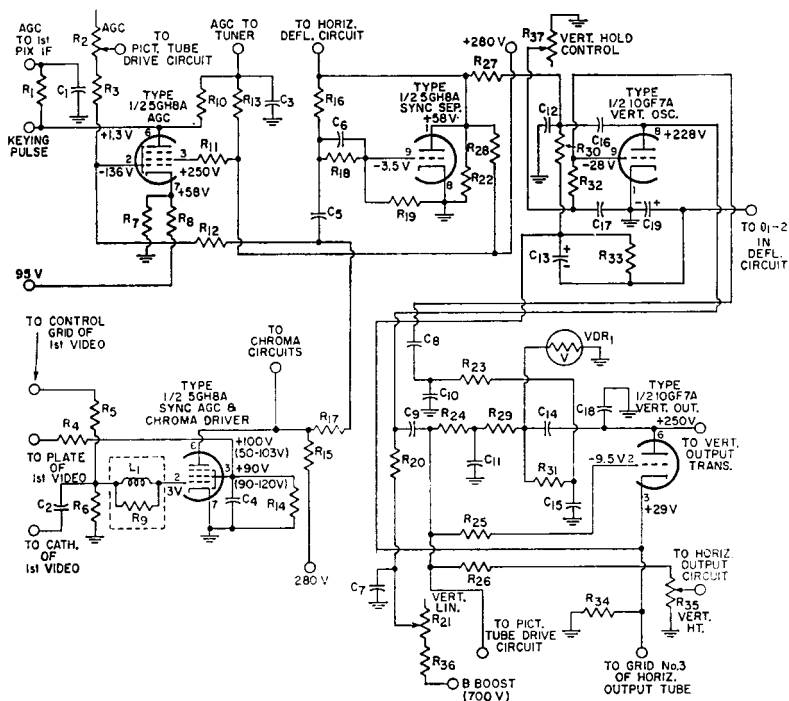
29-32 SYNC, AGC, AND VERTICAL-DEFLECTION CIRCUITS
For Color Television Receiver

Parts List

C₁=0.18 μ F, Mylar, 200 V
 C₂=24 pF, ceramic, 500 V, NPO
 C₃, C₁₇=0.01 μ F, ceramic, 500 V
 C₄=1000 pF, ceramic, 500 V
 C₅=3300 pF, ceramic, 500 V
 C₆=470 pF, ceramic, 500 V
 C₇=0.1 μ F, paper, 600 V

C₈=0.0056 μ F, Mylar, 400 V
 C₉=0.01 μ F, Mylar, 600 V
 C₁₀, C₁₅=680 pF, ceramic, 500 V
 C₁₁=0.047 μ F, Mylar, 100 V
 C₁₂=1500 pF, ceramic, 500 V
 C₁₃=50 μ F, electrolytic, 75 V

C₁₁=0.0082 μ F, paper, 1000 V
 C₁₆=0.033 μ F, Mylar, 600 V
 C₁₈=0.001 μ F, ceramic, 3000 V
 C₁₉=25 μ F, electrolytic, 25 V
 L₁=RF choke, 120 μ H, part of assembly with R₆, RCA Stock No. 120795 or equiv.

29-32 SYNC, AGC, AND VERTICAL-DEFLECTION CIRCUITS (Cont'd)

Parts List (Cont'd)

R ₁ , R _{1c} =0.15 megohm, 0.5 watt	0.5 watt	R ₂₂ =0.22 megohm, 0.5 watt
R ₂ =Potentiometer, agc adjustment, 50000 ohms, 0.5 watt, RCA Stock No. 120804 or equiv.	R ₁₃ =10 megohms, 0.5 watt	R ₂₃ =3300 ohms, 1 watt
R ₃ =27000 ohms, 0.5 watt	R ₁₄ =22000 ohms, 0.5 watt	R ₃₁ =1500 ohms, wirewound, 3 watts
R ₄ =3300 ohms, 0.5 watt	R ₁₅ =10000 ohms, 3 watts	R ₃₂ =Potentiometer, vertical- height control, 1 megohm, 0.5 watt, RCA Stock No. 120805 or equiv.
R ₅ , R ₁₇ , R ₂₅ =10000 ohms, 0.5 watt	R ₁₆ =22 megohms, 0.5 watt	R ₃₃ =0.1 megohm, 1 watt
R ₆ =6800 ohms, 0.5 watt	R ₁₈ =3.3 megohms, 0.5 watt	R ₃₇ =Potentiometer, vertical- hold control, 0.75 meg- ohm, 0.5 watt
R ₇ =27000 ohms, 1 watt	R ₁₉ =1.5 megohms, 0.5 watt	VDR ₁ =Voltage-dependent resistor (varistor); 870 volts at 1 mA; RCA Stock No. 112876 or equiv.
R ₈ =1500 ohms, 0.5 watt	R ₂₁ =Potentiometer, vertical- linearity control, 3.4 meg- ohms, 0.5 watt, RCA Stock No. 120807 or equiv.	See Note on page 726.
R ₉ =68000 ohms, 0.5 watt, part of assembly with L ₁	R ₂₂ =56000 ohms, 0.5 watt	
R ₁₀ =0.56 ohms, 0.5 watt	R ₂₃ =47000 ohms, 0.5 watt	
R ₁₁ =1800 ohms, 0.5 watt	R ₂₄ =4.7 megohms, 0.5 watt	
R ₁₂ , R ₂₇ , R ₃₁ =0.12 megohm,	R ₂₅ =1000 ohms, 0.5 watt	
	R ₂₆ =1.5 megohms, 0.5 watt	
	R ₂₈ =0.47 megohm, 0.5 watt	
	R ₃₀ =33000 ohms $\pm 5\%$,	

Circuit Description

This circuit shows the sync-agc-and-chroma driver, agc amplifier, sync separator, and vertical deflection circuit for a color television receiver. The sync-agc-and-chroma driver, the sync separator, and the vertical output tube operate from a plate supply (B+) voltage of 280-volts obtained from the receiver low-voltage power supply. The plate supply voltage for the agc amplifier is a positive keying pulse from the horizontal-output transformer, and the plate voltage for the vertical oscillator is obtained from the 700-volt B Boost supply in the horizontal output circuit. The tube heaters are connected into the series-heater string for the over-all color receiver; operating power for the heater string is obtained directly from the ac power line.

The drive signal for the sync and agc circuits is obtained from the cathode of the first video amplifier (shown in circuit 29-31). This signal is coupled by capacitor C₂ and the parallel LR network L₂ and R₆ to the control grid of the 5GH8A pentode section used in the sync-agc-and-chroma driver. (The triode section of the 5GH8A tube is used in the first video amplifier). The screen-grid and control-grid bias voltages for the driver pentode are also obtained from the first video amplifier. The output of the driver stage is applied to the control grids of the agc

amplifier and the sync separator and to the chroma circuits (shown in circuit 29-34).

The agc amplifier uses the pentode section of a 5GH8A triode-pentode; the triode section of this tube is used in the sync separator. The operation of the agc amplifier is gated by a positive keying pulse from the horizontal-output transformer (shown in circuit 29-33). This pulse, which is synchronized with the video signal, overcomes the bias provided by the 95 volts (obtained from the receiver low-voltage power supply, circuit 29-29) applied to the cathode circuit of the agc amplifier. Portions of the video signal that occur coincident with the keying pulse (i.e. during the horizontal blanking interval) are amplified by the agc stage. Resistor R₁ and capacitor C₁, together with other filtering elements in the control-grid circuit of the first picture if amplifier, filter out the pulsating components in the video signal to obtain a negative dc voltage proportional the video signal and thus to the rf input at the receiver antenna. Similarly, an agc bias voltage for the vhf tuner is developed across the filter capacitor C₃.

Synchronizing pulses are included in the composite rf signals transmitted by a television broadcast station to provide timing information required for synchronization of the transmitter and receiver scan-

29-32 SYNC, AGC, AND VERTICAL-DEFLECTION CIRCUITS (Cont'd)

Circuit Description (Cont'd)

ning systems. The sync separator separates and amplifies the synchronizing pulses contained in the composite video signal it receives from the sync-agc-and-chroma driver. The 5GH8A triode section used in this stage is operated basically as a class C limiter. When the video signal is applied, the stage is biased beyond cutoff by the negative voltage developed by the grid-leak bias network formed by C_6 and R_{18} . Only the sync pulses in the composite video signal have sufficient amplitude to drive the sync amplifier into conduction. The resultant negative pulses developed in the plate circuit of the 5GH8A triode section are applied as the synchronizing inputs to the vertical and horizontal deflection circuits.

The vertical-deflection circuit employs one section of a 10GF7A dual triode in a vertical oscillator stage and a vertical output stage. These two stages form a basic plate-coupled 60-Hz free-running multivibrator that is synchronized by negative vertical sync pulses from the sync separator stage. The negative-pulse output from the sync separator, however, includes horizontal sync pulses and equalizing pulses in addition to the vertical sync pulses. The vertical sync pulses must be

separated from the composite sync-separator output prior to the application of the synchronizing input to the vertical-deflection circuits. This separation is accomplished by integration of the composite sync-separator output across capacitor C_{12} . The integrating network (R_{27} and C_{12}) has negligible response for the narrow horizontal-sync and equalizing pulses, but responds to the greater energy contained in the much wider vertical-sync pulses to develop a triangular voltage waveform, coupled by C_{18} , C_9 , and R_{28} to the control grid of the vertical-output triode section, that synchronizes the operation of the multivibrator. The combination of the triangular wave input to the grid of the output section and the square-wave multivibrator signal results in a trapezoidal voltage waveform at the plate of the output section. This trapezoidal voltage wave produces a triangular wave of current through the vertical-output transformer (T_2 in circuit 29-33) and through the vertical deflection coils of the picture tube (shown in circuit 29-35). The rising portion of the triangular current waveform produces the vertical scanning, and the decreasing portion of the waveform provides the retrace.

29-33 HORIZONTAL-DEFLECTION CIRCUIT AND HIGH VOLTAGE POWER SUPPLY

For Color Television Receiver

Circuit Description

These circuits develop the horizontal scanning signals and the dc operating voltage (21,500 volts) for the color picture tube (RCA Type 15LP22) and the receiver B Boost voltage (700 volts). The circuits operate from the receiver low-voltage (280-volt) supply. The heaters of the 5GH8A, 24JE6A, and 17KV6A tubes used in these circuits are included in the series-heater string for the

over-all receiver; operating power for these heaters is obtained directly from the 117-volt ac power line. Heater power for the 3A3A high-voltage rectifier tube is obtained from a 3-volt secondary winding on the high-voltage transformer.

A blocking oscillator in which the transformer coil is located in the cathode circuit is used to obtain a large-amplitude horizontal-drive

29-33 HORIZONTAL-DEFLECTION CIRCUIT AND HIGH-VOLTAGE POWER SUPPLY (Cont'd)

Parts List (Cont'd)

$R_3=0.27$ megohm, 0.5 watt
 $R_4=100$ ohms, 0.5 watt
 $R_5=15000$ ohms, 0.5 watt
 $R_6=1200$ ohms, 0.5 watt
 $R_7=47$ ohms, 0.5 watt
 $R_8, R_{26}=0.12$ megohm, 0.5 watt
 $R_9=0.15$ megohm, 0.5 watt
 $R_{10}=82000$ ohms, 0.5 watt
 $R_{11}=8.2$ megohms, 0.5 watt
 $R_{12}=680$ ohms, 2 watts
 $R_{13}=82000$ ohms $\pm 2\%$, 0.5 watt
 $R_{14}=82000$ ohms $\pm 5\%$, 4 watts

$R_{15}=100$ ohms, 0.5 watt
 $R_{16}=68000$ ohms, 1 watt
 $R_{17}=33000$ ohms, 0.5 watt
 $R_{18}=1000$ ohms, 2 watts
 $R_{19}=10000$ ohms, 0.5 watt
 $R_{21}=27000$ ohms, 0.5 watt
 $R_{23}=10$ megohms, 0.5 watt
 R_{24} =Potentiometer, high-voltage adjustment, 0.5 megohm, 0.5 watt
 $R_{25}=33000$ ohms, 0.5 watt
 $R_{27}=0.56$ megohm, 0.5 watt
 $R_{28}=0.27$ megohm, 1 watt
 $R_{29}=120$ ohms, 0.5 watt
 $R_{30}=2.2$ megohms, 0.5 watt

R_{31} =Potentiometer, horizontal-hold control, 50000 ohms, 0.5 watt
 SG_1 =Spark-gap capacitor, 0.5 pF, 1000 V, RCA Stock No. 120819 or equiv.
 T_1 =Horizontal-output (flyback) transformer, RCA Stock No. 120820 or equiv.
 T_2 =Vertical-output transformer, RCA Stock No. 120821 or equiv.

See Note on page 726.

Circuit Description (Cont'd)

waveform. A control stage establishes the bias for the oscillator and, in this way, controls the firing of the oscillator stage. The 5GH8A triode-pentode is used in these stages. The triode section is used as the oscillator tube; the pentode section is used as a high-gain, low-drift control tube.

When the composite video signal is generated at the television broadcast station, the leading edge of each horizontal sync pulse, of alternate equalizing pulses, and of alternate serrations of the vertical sync pulses are correctly timed to initiate the horizontal retrace period. These leading-edge components are extracted from the composite output from the sync separator (shown in circuit 29-31) and are used to synchronize the operation of the horizontal oscillator.

The sync waveform is differentiated by the RC network (C_1 and R_2) at the input to the horizontal deflection circuit to obtain negative and positive voltage spikes that correspond to the leading and lagging edges, respectively, of the rectangular sync pulses. The amplitude of these voltage spikes is dependent upon only the peak value of the sync pulses and is not affected by the time durations of these pulses. The differentiating circuit, therefore, does not respond to the flat portions of the vertical sync pulses; as a result, with the exception of the serrations,

the vertical sync pulses do not affect the operation of the horizontal-deflection circuits. The leading edge of alternate serrations, however, correspond to the start of horizontal-retrace periods and thus may be considered as merely another horizontal sync signal.

The differentiated sync waveform is applied to the junction of the twin silicon diode CR_1 used in a phase-discriminator type of afc network. The positive voltage spikes in the differentiated waveform have no effect on the discriminator network. The negative-voltage spikes are compared with pulses feedback from the horizontal oscillator to derive the synchronizing voltage. The frequency of the horizontal oscillator and the repetition rate of the horizontal sync pulses should both be 15,750 Hz, the desired horizontal scanning rate for the picture tube. If the pulses from the oscillator are not coincident with the horizontal sync pulses, the phase discriminator develops an error voltage at the control grid of the control tube. The control tube then varies the bias and, thus, the firing point of the oscillator until it is locked in phase with the horizontal sync pulses.

The parallel LC network (L_2 and C_{12}) in the cathode circuit of the oscillator resonates at 15,750 Hz to provide frequency stabilization for the oscillator. The HOLD control R_{31} adjusts the frequency of the oscil-

29-33

**HORIZONTAL-DEFLECTION CIRCUIT AND
HIGH-VOLTAGE POWER SUPPLY (Cont'd)****Circuit Description (Cont'd)**

lator to achieve an exact lock-in with the horizontal sync pulses. The output of the blocking oscillator is coupled through C_{14} and R_1 to the control grid of the 24JE6A power pentode used in the horizontal-output stage. This tube drives the high-voltage flyback transformer T_1 that develops the scanning voltage for the horizontal deflection coils (shown in circuit 29-35).

The sudden cutoff of plate current in the horizontal output stage at the end of the trace period causes a very large, positive-going voltage pulse to be generated across the high-voltage transformer T_1 . The 3A3A half-wave rectifier circuit converts this pulse to a positive dc of 21,500 volts which is applied to the second anode of the color picture tube.

Regulation of the high voltage is achieved by use of a 17KV6A pulse-regulator stage connected in shunt with a section of the primary of the high-voltage flyback transformer. The regulator stage acts as a variable load on the flyback pulse source and, in this way, maintains an essentially constant pulse amplitude in the primary winding of the high-voltage transformer with changing loads on the high-voltage supply. This action assures that a constant-amplitude, stepped-up pulse is applied to the 3A3A rectifier. The rectifier output delivered to the picture tube, therefore, is maintained at a constant value of 21,500 volts.

Removal of negative overshoots that would be developed across the high-voltage transformer because of a flywheel effect is accomplished by the damper diode CR_2 . This diode is shaped like a fuse and snaps into clips that can be mounted on the same circuit board with the horizontal deflection circuits and is readily replaced during servicing.

The polarity of the damper diode is such that the positive pulse developed across the high-voltage transformer causes no current flow through it. For negative pulses, however, the damper diode provides a low impedance path for the current, and energy stored in the horizontal output transformer (and the horizontal deflection coils) is dissipated in the damper circuit. The rectified current through the damper diode develops the boosted $B+$ voltage of +700 volts across capacitor C_{21} in the damper anode circuit.

The two auxiliary windings on the high-voltage transformer supply supplementary pulse voltages. The upper winding supplies gating pulses to the burst-gate and the color-killer amplifiers (shown in circuit 29-34). The convergence pulse is developed across the lower auxiliary winding. Keying pulses for the agc amplifier and the horizontal blanking diode are derived from the capacitor network (junction of C_{25} and C_{27}) in the primary circuit of the high-voltage transformer.

Transformer T_2 shown in the circuit diagram is the vertical output transformer. The drive signal from the vertical output stage (shown in circuit 29-32) is developed across the primary of this transformer and coupled by the secondary winding through jack J_2 to the vertical deflection coils (shown in circuit 29-35). An auxiliary winding on transformer T_2 develops the keying pulse for the vertical blanking diode. The horizontal scanning signal from the high-voltage (horizontal-output) transformer are also coupled through jack J_1 to the horizontal deflection coils. The horizontal and vertical signals to the convergence board are routed through jack J_3 . (Jacks J_1 and J_2 mate with plugs P_2 and P_1 , respectively, on circuit 29-35.)

29-34

CHROMA CIRCUITS

For Color Television Receiver

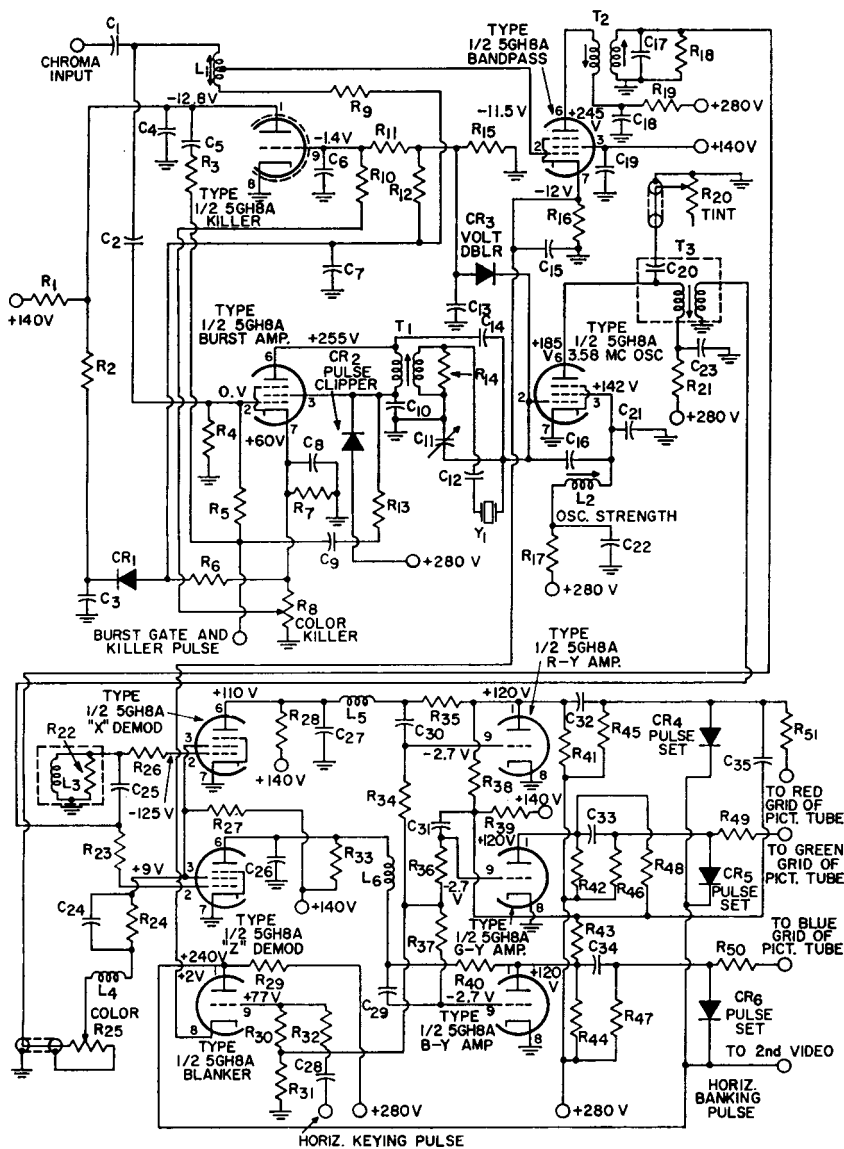

29-34

CHROMA CIRCUITS (Cont'd)

Parts List

- $C_1=27$ pF, ceramic, 500 V, NPO
 $C_2=68$ pF, ceramic, 500 V, N750
 $C_3, C_5, C_6, C_8, C_9, C_{22}, C_{23}, C_{29}$ through $C_{31}=0.01$ pF, ceramic, 500 V
 $C_4=390$ pF, ceramic, 500 V
 $C_7=0.047$ μ F, Mylar, 100 V
 $C_{10}, C_{18}=1000$ pF, ceramic, 500 V
 C_{11} =Trimmer, 2 to 10 pF, RCA Stock No. 116501 or equiv.
 $C_{12}=220$ pF, ceramic, 500 V
 $C_{13}=10$ pF, ceramic, 500 V, N150
 $C_{14}, C_{16}=0.82$ pF $\pm 5\%$, headed lead, 500 V
 $C_{15}=820$ pF, ceramic, 500 V
 $C_{17}=390$ pF $\pm 5\%$, Mylar, 500 V
 $C_{19}, C_{26}, C_{27}=33$ pF, ceramic, 500 V, N150
 $C_{21}=10$ pF $\pm 5\%$, ceramic, 500 V, NPO
 $C_{24}=0.027$ pF, Mylar, 100 V
 $C_{25}=430$ pF $\pm 5\%$, mica, 500 V
 $C_{28}=150$ pF, ceramic, 500 V
 $C_{35}=1.2$ pF, ceramic, 500 V
 CR_1, CR_2, CR_3, CR_6 =Silicon diode, RCA Stock No. 119596 or equiv.
 CR_2 =Diode, pulse clipper, RCA Stock No. 113998
 CR_3 =Diode, type 1N60
 L_1 =Variable inductor, chroma-takeoff coil, RCA Stock No. 120797 or equiv.
 L_2 =Variable inductor, oscillator strength adjustment, RCA Stock No. 120798 or equiv.
 L_3 =Phase-shift coil, 3.9 μ H, part of quadrature assembly (RCA Stock No. 120830 or equiv.) with R_{22}
 L_4 =RF coil, 3.9 μ H, RCA Stock No. 116510 or equiv.
 L_5, L_6 =RF choke, 620 μ H, RCA Stock No. 109257 or equiv.
 $R_1=3.9$ megohms, 0.5 watt
 $R_2=0.15$ megohm, 0.5 watt
 $R_3, R_4, R_7=47000$ ohms, 0.5 watt
 $R_5=82000$ ohms, 0.5 watt
 $R_6, R_{10}=10$ megohms, 0.5 watt
 R_8 =Potentiometer, color-killer adjustment, 1 megohm, 0.5 watt, RCA Stock No. 120805 or equiv.
 $R_9=82$ ohms, 0.5 watt
 $R_{11}=2.7$ megohms, 0.5 watt
 $R_{12}=2.2$ megohms, 0.5 watt
 $R_{13}=3900$ ohms, 0.5 watt
 $R_{11}, R_{16}=390$ ohms, 0.5 watt
 $R_{15}=82000$ ohms, 0.5 watt
 $R_{17}=47000$ ohms, 1 watt
 $R_{14}=560$ ohms, 0.5 watt
 $R_{18}=1500$ ohms, 0.5 watt
 R_{20} =Potentiometer, tint control, 10000 ohms, 0.5 watt, RCA Stock No. 120774 or equiv.
 $R_{21}=6800$ ohms, 1 watt
 $R_{23}=120$ ohms $\pm 5\%$, 1 watt, part of quadrature assembly with L_3
 $R_{24}, R_{26}=470$ ohms, 0.5 watt
 $R_{21}=1500$ ohms, 0.5 watt
 R_{25} =Potentiometer, color control, 500 ohms, 0.5 watt, RCA Stock No. 120776 or equiv.
 $R_{27}=0.1$ megohm, 0.5 watt
 $R_{28}, R_{29}=6800$ ohms $\pm 5\%$, fixed film, 0.5 watt
 $R_{30}=4700$ ohms $\pm 5\%$, 1 watt
 $R_{31}=0.22$ megohm, 0.5 watt
 $R_{32}=8200$ ohms, 0.5 watt
 $R_{33}=68000$ ohms, 0.5 watt
 $R_{34}=8200$ ohms $\pm 5\%$, fixed film, 0.5 watt
 $R_{31}, R_{36}, R_{37}=1$ megohm, 0.5 watt
 $R_{35}, R_{10}=0.18$ megohm, 0.5 watt
 $R_{38}=0.33$ megohm, 0.5 watt
 $R_{41}, R_{42}, R_{44}=39000$ ohms $\pm 5\%$, 1 watt
 $R_{43}=0.56$ megohm, 0.5 watt
 $R_{15}, R_{16}, R_{17}=2.2$ megohms, 0.5 watt
 $R_{18}=0.39$ megohm, 0.5 watt
 $R_{19}, R_{20}, R_{21}=1000$ ohms, 0.5 watt
 T_1 =Burst transformer, RCA Stock No. 120816 or equiv.
 $T_2=3.58$ -MHz oscillator transformer, RCA Stock No. 120815 or equiv.
 $Y_1=3.58$ -MHz oscillator crystal

Circuit Description

These circuits extract the color information from the 3.58-MHz chrominance sidebands included in the composite color video signal. The color information is included in the chrominance sidebands in the form of two difference-frequency components that have a phase difference of 90 degrees and that are derived in the color television transmitter by subtraction of the luminance (Y) signal from the red (R) and blue (B) color signals. [The green color-difference (G—Y) components are not transmitted, but instead, are derived in the color receiver by addition of complements (negative values) of the R—Y and B—Y signals.] To accomplish the demodulation function, the chroma circuits are required to develop two continuous-wave 3.58-MHz signals that have a phase difference of 90 degrees, each of which much be added

vectorially to the chrominance sidebands. In other words, the 3.58MHz color subcarrier suppressed during transmission must be reinserted by the chroma circuits before the R—Y and B—Y color-difference information contained in the chrominance sidebands can be detected.

The chroma circuits operate from the color receiver low-voltage (280-volt) power supply. Five 5GH8A triode-pentodes fulfill the electron-tube requirements for the ten chroma stages. The heaters of these tubes are connected in series with those of other tubes in the receiver; operating power for the series-heater string is obtained directly from the 117-volt ac power line.

The input to the chroma circuits is the composite video signal after it has been amplified by the first video amplifier and the sync-agc-

29-34

CHROMA CIRCUITS (Cont'd)

Circuit Description (Cont'd)

and-chroma driver (shown on circuits 29-32 and 29-33, respectively). In addition to the chrominance sidebands, this composite signal includes the luminance signal (equivalent to the monochrome picture signal in black-and-white transmissions), the conventional horizontal and vertical sync pulses, and the color burst synchronizing signal. The color "burst" is a 3.58 MHz reference signal of approximately 8 cycles that occurs during the horizontal retrace blanking interval immediately following the horizontal sync pulse (refer to Fig. 96, page 73).

The chroma input is applied simultaneously to the chroma bandpass and burst amplifiers. When no burst signal is included in the chroma input (i.e., for black-and-white transmissions), the color-killer stage develops, by means of the current through diode CR_1 , a negative dc voltage across capacitor C_7 that biases the chroma bandpass amplifier beyond cutoff; as a result the chroma input is not applied to the color demodulators.

The operation of the burst amplifier is controlled by a gating signal (burst-gate and killer pulse) from an auxiliary winding on the horizontal-output transformer (T_1 in circuit 29-33). This gating pulse is generated at the same time and has the same time duration as the horizontal blanking pulse used to blank out the horizontal retrace on the color picture tube. This interval corresponds to the period of the horizontal sync pulse and the 3.58MHz burst synchronizing signal that immediately follows the sync pulse. The burst amplifier, therefore, only amplifies this portion of the chroma input. The primary of transformer T_1 in the plate circuit of the burst amplifier, however, is tuned to 3.58 MHz so that only the 3.58-MHz burst signal is coupled from the plate of the burst amplifier.

The separated burst is coupled by transformer T_1 to the control-grid circuit of a 3.58-MHz injection-locked oscillator circuit. The oscillator, therefore, is forced to operate in step (with respect to both frequency and phase) with the incoming burst signal. The 3.58-MHz crystal Y_1 is used to assure excellent frequency stability in the oscillator circuit. The oscillator develops the continuous-wave 3.58-MHz reference signal applied to the control grids of the Z and X demodulators. The quadrature network (L_3 and R_{23}) causes a 90-degree phase shift in the 3.58-MHz signal applied to the control grid of the X demodulator. The 3.58-MHz chrominance sidebands must also be applied to the X and Z demodulators before these stages can derive the color difference signals. These sideband signals are obtained from the chroma bandpass amplifier.

The dc bias voltage developed in the grid circuit of the oscillator stage is used to control color-killer action and to derive an agc voltage for the chroma bandpass amplifier. The cathode-to-grid section of the oscillator triode, diode CR_3 , and associated components form a two-diode voltage-doubler circuit. Any dc voltage developed in the oscillator grid circuit is approximately doubled at the voltage-doubler output (anode circuit of diode CR_3). When no color signal is received (i.e., no burst signal applied to the oscillator), the dc voltage at the grid of the oscillator is approximately -5 volts. The -10 volts developed across C_{13} and R_{15} in the anode circuit of voltage-doubler diode CR_3 is reduced to approximately -1.4 volts at the control grid of the color-killer stage. For this low level of bias, the color killer stage conducts and develops a cutoff bias for the chroma bandpass amplifier.

When color signals are being

Circuit Description (Cont'd)

received, the burst signals applied to the oscillator causes the oscillator grid bias voltage to increase to approximately -8 volts, depending on the amplitude of the burst signal. The dc voltage at the anode of the voltage-doubler diode then rises to approximately -16 volts, and the bias on the color-killer stage is increased to about -4 volts. For this bias level, no current flows through the color-killer stage, and the cutoff bias for the chroma bandpass amplifier provided by the color-killer stage is removed. The grid bias for the bandpass amplifier is then derived from the dc voltage at the grid of the 3.58-MHz oscillator. Because this voltage varies with the amplitude of the burst signal, it provides automatic-gain control for the bandpass amplifier.

With the removal of the cutoff bias provided by the color killer, the bandpass amplifier is allowed to amplify and pass the 3.58-MHz chrominance sidebands contained in the chroma input (video signal). The single-tuned transformer T_2 in the plate circuit of the bandpass amplifier forms a selective load to the 3.58-MHz chrominance sidebands. The output of the bandpass amplifier, therefore, is a 3.58-MHz signal that contains the $R - Y$ and $B - Y$ color-difference information. The instantaneous phase difference of the 3.58-MHz color-difference components with respect to the burst synchronizing signal defines the color information being transmitted, as indicated by the chart on page 73 in the section **Electron Tube Applications**.

The 3.58-MHz color-difference signals from the bandpass amplifier are coupled by transformer T_2 to the screen grids of the X and Z color demodulators where they are mixed with the continuous-wave 3.58-MHz signal from the oscillator. The color demodulators are essentially

synchronous detectors. These types of detectors are phase sensitive, and their output is determined not only by the amplitudes of the two input signals, but also by the phase relationship of these inputs. If the amplitudes of the chrominance and continuous wave inputs to the demodulators are considered to be constant, the input of the demodulators is affected by the phase relationship of the two input signals as follows: When the chrominance and the continuous signals are in phase, the output of the demodulators is maximum in the negative direction. When the two signals are 180 degrees out of phase, the output is maximum in the positive direction. A phase difference of 90 or 270 degrees results in a zero output from the demodulators.

The X and Z color demodulators are biased so that the plate current of each demodulator tube is small during the zero-signal condition. The continuous-wave signal applied to the control grid gates the tube into conduction for the full positive half cycle. During most of the negative half cycle, the tube is cut off. With no chrominance signal applied to the screen grid, the plate current of the demodulator tube consists essentially of 3.58-MHz pulses. A low-pass filter in the plate circuit of the demodulator removes the 3.58-MHz component so that the dc plate voltage decreases below the level obtained when there is no input to either the control or screen grid. The dc level obtained when only the continuous-wave reference signal is applied represents the zero output of the color demodulators; only changes in the average plate voltage above and below this level will be passed by the output coupling capacitor to the succeeding stages.

When the chrominance signal applied to the screen grid is in phase with the continuous-wave reference signal applied to the control grid,

29-34

CHROMA CIRCUITS (Cont'd)

Circuit Description (Cont'd)

the demodulator tube conducts more heavily during the periods that the reference signal permits conduction. The plate voltage of the demodulator then decreases below the zero level, and the output coupling capacitor couples the negative change to the next stage. Conversely, if the two signals are 180 degrees out of phase, the average plate current decreases. The attendant rise in average plate voltage causes a positive change to be coupled to the next stage. For 90- or 270-degree phase differences, the two signals tend to add together at certain times and to cancel each other times so that the average plate current is essentially unchanged.

In the development of the color-difference signals at the transmitter, the phase of the $R - Y$ signal is shifted 90 degrees with respect to the burst reference signal and the $B - Y$ signal is in phase with the reference signal. The $B - Y$ component of the chrominance sidebands, therefore, is in phase with the reference signal applied to the Z demodulator, and the $R - Y$ component is in phase with the phase-shifted reference signal applied to the X demodulator. The output of the Z demodulator then is the detected $G - Y$ signal, and the output of the X demodulator is the detected $R - Y$ signal. These signals are coupled to the $B - Y$ and $R - Y$ difference-

signal amplifiers, respectively.

If strict consideration is given to signal phase relationships, the outputs of the X and Z demodulators are $-(R - Y)$ and $-(B - Y)$ signals. The positive versions of these color-difference signals results from the inversions provided by the $R - Y$ and $B - Y$ color-difference amplifiers. The $G - Y$ color-difference signal is synthesized by addition of portions of the $R - Y$ and $B - Y$ signals from the plates of the $R - Y$ and $B - Y$ difference amplifiers in the resistor matrix network at the input to the $G - Y$ color-difference amplifier. The vector sum of these quantities results in a $-(G - Y)$ signal. This signal is amplified and inverted by the $G - Y$ amplifier to obtain the $G - Y$ signal.

The color difference amplifiers all operate in the grounded-cathode mode with the grid bias taken from the blanker circuit, and only capacitance coupling is used from the outputs of these amplifiers to the picture tube. The dc reference level for the three color grids of the picture tube are established by a clamp diode circuit in the output of each difference amplifier. The outputs of the $R - Y$, $G - Y$, and $B - Y$ color-difference amplifier are coupled to the red, green, and blue grids, respectively, of the color picture tube.

29-35

PICTURE TUBE AND ASSOCIATED CIRCUITS

For Color Television Receiver

Circuit Description

These circuits include the picture tube and associated input-coupling and biasing networks, the convergence board, and the horizontal and vertical deflection coils for a color television receiver. The dc operating potentials for the picture tube are derived from the receiver low-voltage (280-volt) power supply, the B Boost (700-volt) voltage developed by the horizontal-output circuit, and

the high-voltage (21,500-volt) rectifier circuit. The 6.3 volt heater power for the picture tube is obtained from a transformer (T_1 in circuit 29-29) connected across the 117-volt ac power line.

The 15LP22 color picture tube has a number of unique features. The phosphor-dot screen uses a rare-earth, red-emitting phosphor and improved blue and green phosphors.

29-35 PICTURE TUBE AND ASSOCIATED CIRCUITS (Cont'd)

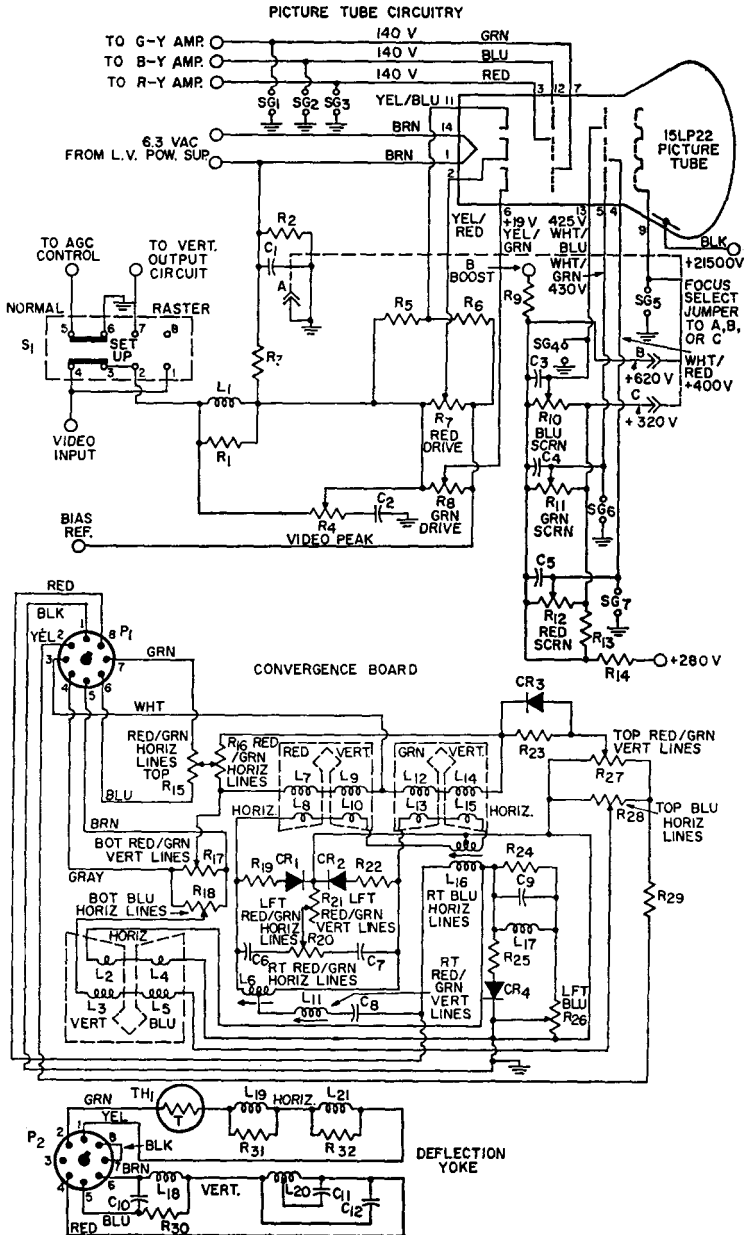

29-35 PICTURE TUBE AND ASSOCIATED CIRCUITS (Cont'd)

Parts List

- $C_1=0.1 \mu\text{F}$, Mylar, 400 V
 $C_2=47 \text{ pF}$, ceramic, 500 V, N750
 $C_3, C_4, C_5=1000 \text{ pF}$, ceramic, 500 V
 $C_6, C_7=0.15 \mu\text{F}$, Mylar, 75 V (part of convergence-board assembly)
 $C_8=0.082 \mu\text{F}$, Mylar, 100 V (part of convergence-board assembly)
 $C_9=0.27 \mu\text{F}$, Mylar, 75 V (part of convergence-board assembly)
 $C_{10}=180 \text{ pF}$, 250 V, part of deflection-yoke assembly
 $C_{11}=3900 \text{ pF}$, part of deflection-yoke assembly
 $C_{12}=82 \text{ pF}$, 3000 V, part of deflection-yoke assembly
 CR_1, CR_2, CR_3, CR_4 =Selenium rectifier assembly, RCA Stock No. 120058 or equiv.
 Convergence board=RCA Stock No. 120052 or equiv.
 Deflection yoke=RCA Stock No. 120890 or equiv.
 $L_1=820 \mu\text{H}$, part of network assembly (RCA Stock No. 120796 or equiv.) with R_1
 (L_2-L_4, L_5-L_5) (L_7-L_6, L_8-L_{10}) ($L_{12}-L_{14}, L_{15}-L_{15}$)=Convergence-coil assembly, RCA Stock No. 121843 or equiv., part of convergence-board assembly
 L_6 =Variable inductor, right red/green vertical lines adjustment, RCA Stock No. 120059 or equiv., part of convergence-board assembly
 L_{11} =Variable inductor, right red/green vertical lines adjustment, RCA Stock No. 121443 or equiv., part of convergence-board assembly
 L_{12} =Variable inductor, right blue horizontal lines adjustment, RCA Stock No. 120060 or equiv., part of convergence-board assembly
 $L_{17}=120 \mu\text{H}$, RCA Stock No. 118245 or equiv., part of convergence-board assembly
 L_{18}, L_{20} =Vertical-deflection coils, part of deflection-yoke assembly
 L_{19}, L_{21} =Horizontal-deflection coils, part of deflection-yoke assembly
 P_1 =Connector for convergence board, 8-pin male type, RCA Stock No. 112728 or equiv. (mates with J_1 on circuit 26-34)
 P_2 =Connector for yoke assembly, 8-pin male type, RCA Stock No. 114767 or equiv. (mates with J_2 on circuit 26-34)
 $R_1=4700 \text{ ohms}$, 0.5 watt, part of network assembly with L_1
 $R_2=0.18 \text{ megohm}$, 0.5 watt
 $R_3=0.15 \text{ megohm}$, 0.5 watt
 R_4 =Potentiometer, video peak adjustment, 0.1 megohm, 0.5 watt, part of assembly with R_7 and R_8 (RCA Stock No. 120811 or equiv.)
 $R_5=5600 \text{ ohms}$, 0.5 watt
 $R_6=12000 \text{ ohms}$, 0.5 watt
 R_7 =Potentiometer, red drive adjustment, 6000 ohms, 0.5 watt, part of assembly with R_6 and R_8 (RCA Stock No. 120811 or equiv.)
 R_8 =Potentiometer, green drive adjustment, 6000 ohms, 0.5 watt, part of assembly with R_6 and R_7 (RCA Stock No. 120811 or equiv.)
 $R_9=33000 \text{ ohms} \pm 5\%$, 0.5 watt
 R_{10}, R_{11}, R_{12} =Three-section potentiometer; screen-grid adjustments for blue, green, and red electron guns, respectively; each section: 1.5 megohms, 0.5 watt; RCA Stock No. 120812 or equiv.
 $R_{13}=47000 \text{ ohms}$, 0.5 watt
 $R_{14}=1000 \text{ ohms}$, 0.5 watt
 R_{15} =Potentiometer, top red/green horizontal lines adjustment, 120 ohms, 0.5 watt, RCA Stock No. 106320 or equiv. (part of convergence-board assembly)
 R_{16} =Potentiometer, bottom red/green horizontal lines adjustment, 350 ohms, 0.5 watt, RCA Stock No. 116635 or equiv. (part of convergence-board assembly)
 R_{17} =Potentiometer, bottom red/green vertical lines adjustment, 60 ohms, 0.5 watt, RCA Stock No. 105059 or equiv. (part of convergence-board assembly)
 R_{18} =Potentiometer, bottom blue horizontal lines adjustment, 60 ohms, 0.5 watt, RCA Stock No. 105059 or equiv. (part of convergence-board assembly)
 $R_{19}, R_{20}=100 \text{ ohms}$, 1 watt, part of convergence-board assembly
 R_{21} =Potentiometer, left red/green vertical lines adjustment, 100 ohms, 0.5 watt, RCA Stock No. 120949 or equiv. (part of convergence-board assembly)
 $R_{22}=270 \text{ ohms}$, 0.5 watt (part of convergence-board assembly)
 $R_{23}=180 \text{ ohms}$, 1 watt (part of convergence-board assembly)
 $R_{24}=270 \text{ ohms}$, 1 watt (part of convergence-board assembly)
 R_{25} =Potentiometer, left blue adjustment, 60 ohms, 3 watts, RCA Stock No. 114627 or equiv. (part of convergence-board assembly)
 R_{27} =Potentiometer, top red/green vertical lines adjustment, 350 ohms, 0.5 watt, RCA Stock No. 116635 or equiv. (part of convergence-board assembly)
 R_{28} =Potentiometer, top blue horizontal lines adjustment, 350 ohms, 0.5 watt, RCA Stock No. 116635 or equiv. (part of convergence-board assembly)
 $R_{29}=82 \text{ ohms}$, 0.5 watt (part of convergence-board assembly)
 $R_{30}=4700 \text{ ohms}$, 2 watts (part of deflection-yoke assembly)
 $R_{31}, R_{32}=220 \text{ ohms}$, 0.5 watt
 S =Service switch, RCA Stock No. 120838 or equiv.
 SG_1 through SG_7 =Capacitor, spark-gap, 0.5 pF, 1000 V, RCA Stock No. 120019 or equiv.
 TH_1 =Thermistor; cold resistance, 1.3 ohms; RCA Stock No. 120891

See Note on page 726.

Circuit Description (Cont'd)

The new phosphors are more efficient and are capable of producing 38 per cent brighter highlights than previous color picture tubes. The directly viewed shadow-mask picture

tube incorporates a screen with nearly straight sides and sharply rounded corners.

The 15LP22 is designed for operation with the blue gun down. The

29-35 PICTURE TUBE AND ASSOCIATED CIRCUITS (Cont'd)**Circuit Description (Cont'd)**

anode bulb contact for high voltage connection is still located in the top section of the tube. Operation in the blue-down orientation, with respect to the viewing screen, provides optimum compromise of pincushion distortion at the top and bottom of the screen. The tube is equipped with an integral filter glass protective window, sealed to the base plate of the tube with a clear resin. An external magnetic shield is not required on the 15LP22. Another main feature of the color picture tube is an einzel-lens focus system. This system is relatively insensitive to variations of the high voltage so that the tube maintains good focus even with variations in picture brightness.

The focus system for the color picture tube is very similar to that used in instruments equipped with a black-and-white picture tube. Normally, the 15LP22 will have optimum focus when connected to ground potential. However, provisions to change the focus potential are facilitated by a pin connector from pin 9 of the picture tube. The focus selected jumper can be connected to 620 volts, 320 volts, or ground merely by relocating the slip-on connector to the proper stake extending from the circuit board.

A three-position service switch S_1 is incorporated into the picture-tube circuitry to facilitate receiver setup and adjustment. The NORMAL position of the switch, of course, permits normal receiver operation. With the switch in the SETUP or RASTER position, the video input is disconnected from the picture tube, and the ground return for the agc circuit is opened. Raster height and width and color and background levels can then be more easily adjusted.

The output of the color difference amplifiers are applied to the respective grids of the tricolor picture tube. The luminance signal from the

second video amplifier is applied to the three cathodes of the color picture tube. These signals combine to intensity modulate the three electron beams to produce the color image on the picture-tube screen.

The horizontal and vertical deflection coils in a yoke on the neck of the picture tube deflect the electron beams, in response to signals received from the horizontal and vertical output stages, to produce the horizontal and vertical scanning required to trace the image on the picture-tube screen. (These coils are connected in shunt with the respective horizontal and vertical output transformer.)

The horizontal output circuit provides a sawtooth current waveform at a frequency of 15,750 Hz to the horizontal-deflection coils, and the vertical output circuit provides a 60-Hz sawtooth current wave to the vertical-deflection coils. The picture tube electron beams are simultaneously deflected horizontally across the screen at a rate of 15,750 Hz and vertically at a rate of 60 Hz.

At the completion of each horizontal trace (end of rising portion of sawtooth current wave), the beam is deflected back to the left side of the screen (retrace) to start another trace period. A positive blanking pulse (included in the video signal) applied to the cathodes of the picture tubes cuts off the picture tube during this period so that the retrace lines do not appear on the tube screen. The picture tube is similarly blanked at the end of each vertical-trace period.

Correct color reproduction requires that the three beams of the color picture tubes meet, or converge, at the shadow mask and excite color dots of the same trios. The three electron guns of the color picture tube are mechanically tilted toward the center axis of the tube so that virtual convergence is ob-

29-35 PICTURE TUBE AND ASSOCIATED CIRCUITS (Cont'd)**Circuit Description (Cont'd)**

tained with no external converging force applied. Slight bending of one or more of the beams may be required for exact convergence. The convergence circuit performs this function.

The components on the convergence board shown in the circuit diagram are mounted on a disk-shaped circuit board with a center hole that permits it to be fitted directly on the neck of the color picture tube. These components are interconnected in a dynamic type of convergence system. In this system, sine wave currents are used to provide horizontal convergence, and parabolic current waves are used to provide vertical convergence.

The sine waves of current used to provide horizontal convergence are derived from a voltage pulse developed across an auxiliary winding of the high-voltage transformer (T_1 in circuit 29-33) and applied through pin 8 of the convergence-board input connector P_1 . The current through each of the three sets of horizontal convergence coils (L_2 and L_4 , L_8 and L_{10} , and L_{13} and L_{15}) is individually adjustable in both amplitude and phase. The phase of the convergence current is adjusted by the Horizontal Shape control L_6 , which resonates with the two 0.15-microfarad capacitors C_6 and C_7 at the line frequency (15,750 Hz). The sine-wave convergence current is produced by ringing this resonant

circuit with the pulse obtained from the high-voltage transformer. Potentiometers R_{15} , R_{16} , R_{18} , R_{20} , and R_{23} adjust the amplitude of the sine-wave convergence current.

Vertical-frequency (60-Hz) sawtooth voltages obtained from secondary windings of the vertical-output transformer (T_2 in circuit 29-33), applied through pins 4 and 5 and pins 6 and 7 of connector P_1 , are used to derive the vertical convergence-current waveform. Because of the integrating action of the convergence coils, this sawtooth voltage results in a parabolic current wave through the convergence coils. Potentiometer R_{21} adjusts the amplitude of the vertical voltage parabola applied to the three sets of vertical convergence coils (L_3 and L_5 , L_7 and L_9 , and L_{12} and L_{14}).

A vertical-frequency sawtooth voltage from a secondary winding of the vertical-output transformer, is applied across potentiometer R_{17} . The sawtooth voltage is obtained from center tapped transformers; the voltage at the center of potentiometer R_{17} therefore, is approximately zero with respect to circuit ground. Adjustment of this potentiometer mixes either positive or negative sawtooth voltages with the parabolic convergence voltage and, in this way, controls the shape of the convergence signal applied to the convergence coils.

INDEX

	<i>Page</i>		<i>Page</i>
Absolute Maximum System of Ratings ..	95	Bias:	
AC/DC Superheterodyne Receiver	677	battery	84
Admittance, Input	27	cathode (self)	84
All-Purpose Power Supplies	711	diode	21
AM Detection	19	grid-resistor	22, 85
AM/FM Receiver	678	Black-and-White Television Receiver ..	710
Amplification	24	Burst	60, 73
Amplification Factor (μ)	13	Bypassing	84
Amplifier:		Calculation of:	
audio-frequency	15, 25	amplification factor	13
audio mixer, circuit	700	cathode (self-bias) resistor	84
cathode-drive	37	cathode load resistor	42
cathode-follower	40	control-grid-plate transconductance ..	14
Class A	25, 28	filament resistor power dissipation ..	82
class AB	25, 34	filament (or heater) resistor value ..	82
class AB ₁	34	gain-bandwidth product	57
class AB ₂	37	harmonic distortion	30, 32
class B	25, 37	load resistance	31, 35
class C	25	noise figure	55
high-fidelity	49, 90	operating conditions from	
intermediate-frequency, circuit	684	conversion nomograph	32
limiter	50	peak inverse plate voltage	97
luminance	60	plate efficiency	14
parallel	28	plate resistance	14
phase-inverter	51	power output	29, 35
preamplifier circuits .. 702, 703, 704, 705		power sensitivity	14
push-pull	25, 28, 31	Q (selectivity)	52
radio-frequency	25, 52	resonant frequency	52
remote-cutoff	27, 56	screen-grid voltage dropping resistor	99
resistance-coupled	26	transconductance	14, 41
sync	63	voltage amplification (gain)	26, 40
television	56	Capacitive Division	54
tone-control	45	Capacitor-Input Filter	89
tone-control, circuit	706	Cathode:	
video	58, 60	bias	84
voltage	25	bypassing	84
volume-expander	50	connection	83
Amplifiers:		current	83
if	52	directly heated	3
tuned	52	drive	37
wideband	58	follower	38, 40
Amplitude Modulation (AM)	19	indirectly heated	4
Anode	5	ionically-heated	6
Application Guide for RCA		resistor	84
Receiving Tubes	104	types	3
Arc-Back Limit	97	Characteristics Curves, Interpretation of	98
Audio Mixer	700	Characteristics:	
Electronic Volt-Ohmmeter	707	amplification factor	13
Automatic Frequency Control (AFC)	76	control-grid-plate transconductance ..	14
Automatic Gain Control (AGC)	46, 48	conversion transconductance	14
Automatic Volume Control (AVC)	46	dynamic	13
Bass and Treble Tone-Control		picture tube X-radiation	14
Amplifier Stage	702	plate resistance	14
Beam Power Tubes	9	static	13

	<i>Page</i>		<i>Page</i>
Charts and Tables:		Current:	
grid-No. 2 input rating chart	300	cathode	83
outline drawings	633	dc output	96
picture tube characteristics chart ..	666	grid	86
resistance-coupled amplifier	641	peak plate	75
types for replacement use	522	plate	5
Choke-Input Filter	89	Curves, Interpretation of Characteristic ..	98
Chroma Circuits	741	Cutoff	27
Chrominance Channel	61		
Circuit Diagram of:		Dark Heater	4
ac/dc superheterodyne radio receiver ..	677	Deflection Circuits:	
all-purpose power supplies	711	horizontal	67
AM/FM superheterodyne radio		vertical	68
receiver	677	Degeneration (See Inverse Feedback) ...	38
bass and treble tone-control amplifier ..	706	Delayed Automatic Volume Control	
chroma circuits	741	(DAVC)	47
code practice oscillator	690	Demodulation	19, 72
FM stereo multiplex adapter	686	Design-Center System of Ratings	95
FM tuner	682	Design-Maximum System of Ratings	95
high-fidelity, 15-w audio amplifier ..	692	Detection:	
high-fidelity, 30-w audio amplifier ..	694	AM	19
high-fidelity, 50-w audio amplifier ..	696	diode	20
horizontal-deflection circuit and high-		discriminator	23
power supply (for color		FM	22
TV receiver)	735	grid bias	21
intercommunication set	691	grid resistor and capacitor	22
low-distortion preamplifier	705	ratio detector	24
low-voltage and heater supply		synchronous	72
(for TV receiver)	724	Diode:	
low-voltage power supply, degaussing		biasing	21
circuit, and heater connections		considerations	5
(for color TV receiver)	726	detection	20
microphone and phonograph		Discriminator	23
amplifier	699	Dress of Circuit Leads	88
phonograph amplifier	701	Dynamic Characteristics	13
picture tube and associated circuits			
(for color TV receiver)	745	Electron:	
preamplifier for amateur receiver ..	694	considerations	3
preamplifier for ceramic phonograph-		secondary	8, 9
pickup	704	Electrons, Electrodes, and Electron Tubes	
preamplifier for magnetic		Electron Tube Application	15
phonograph-pickup	702	Electron Tube Characteristics	13
preamplifier for tape-head pickup ..	703	Electron Tube Installation	81
sync, agc, and vertical-deflection		Electron Tube Testing	100
circuits (for color TV receiver) ..	735	Electron-Ray Tubes	79
three-stage if amplifier/limiter and		Emission:	
ratio detector	684	current	5
two-channel audio mixer	700	secondary	8, 9
two-channel, 1-w stereo amplifier ..	698	test	101
vertical and horizontal deflection		Feedback, Inverse	25, 38
circuits and high-voltage rectifier ..	720	Filament (also see Heater and Cathode):	
vhf. tuner	713	operation	3, 81
video, agc, and sync amplifiers	718	resistor	81
video and sound-channel circuits		series operation	81
(for color TV receiver)	731	shunt resistor	82
video if amplifiers and sound-channel		supply voltage	81
circuits	716	Filter:	
Circuits	674	capacitor-input	89
Code-Practice Oscillator	688	choke-input	89
Color Demodulation	72	corrective	43
Color Picture Tubes	12	radio-frequency	89
Color Television	60	smoothing	89
Communications Transceiver	16	FM Detection	22
Contact Potential	86	FM Stereo Multiplex Adapter	686
Conversion Nomograph, Use of	33	FM Tuner	682
Conversion Transconductance	14	Formulas (see Calculation)	
Corrective Filter	43		
Cross-Modulation	27		

	<i>Page</i>		<i>Page</i>
Frame Grid	7	Low-Voltage Power Supply, Degaussing Circuit, and Heater Connections (for Color TV Receiver)	726
Frequency Conversion	77	Luminance Amplifier	60
Frequency Modulation (FM)	22		
Full-Wave Rectifier	5, 17		
Gain (Voltage Amplification)	26	Maximum Ratings	95
General System Functions	15	Mercury-Vapor Rectifier: considerations	6
Generic Tube Types	4	interference from	89
Grid:		Mho-micromho	14
bias	85	Microphone and Phonograph Amplifier .	699
cathode detection	21	Mixer:	
control	7	audio	700
current	86	hexode	79
resistor	85	pentagrid	74
resistor and capacitor detection	22	vhf tuner	56
screen	7	Modulated Wave	19
suppressor	8	Modulation	19
voltage supply	83	Modulation-Distortion	27
Grid-Plate Capacitance	7	Multi-Electrode and Multi-Unit Tubes ..	9
Grid-Plate Transconductance	14	Multiplex Adapter for FM Stereo	686
		Multivibrator	74
Half-Wave Rectifier	5, 17	Noise	54
Harmonic Distortion	30, 49	Noise Figure	55
Heater:		Noise Immunity	67
cathode	4	Novar	10
cathode bias	83	Nuvistor	10
cathode connection	83		
resistor	82		
series operation	82	Operation, Typical Values	98
supply voltage	81	Oscillator:	
warm-up time	95	considerations	74
High-Fidelity Amplifiers	49, 90	local	57
High-Fidelity, 15-w Audio Amplifier	692	multivibrator	75
High-Fidelity, 30-w Audio Amplifier	694	relaxation	75
High-Fidelity, 50-w Audio Amplifier	696	synchroguide	75
High-Voltage Regulation	69	Output Capacitance	98
High-Voltage Regulators:		Output-Coupling Devices	90
Shunt Regulator Circuit	69		
Pulse Regulator Circuit	70	Parallel Operation	28
Horizontal Deflection	66	Peaking:	
Horizontal-Deflection Circuit and High- Voltage Power Supply	737	series	58
Hum and Noise Characteristics	98	shunt	58
		Peak heater-cathode voltage	96
IF Amplifier/Limiter and Ratio Detector	684	Peak Inverse Plate Voltage	97
Impedance, Input	27	Peak Plate Current	97
Injection Voltage	56	Pentagrid Converter	10
Input Admittance	27	Pentagrid Mixer	79
Input Capacitance	98	Pentode Considerations	8
Instantaneous Peak Voltage	97	Phase Inverter	51
Intercommunication Set	689	Phonograph Amplifier	701
Interelectrode Capacitances	7, 98	Phonograph and Tape Preamplifiers ..	43
Intermodulation Distortion	49	Picture Tube:	
Interpretation of Tube Data	95	characteristics chart	666
Inverse Feedback:		corona considerations	92
constant-current type	40	cutaway view of color tube	12
constant-voltage type	38	deflection	11
		dust considerations	91
Kinescopes	10	essential elements	10
		handling precautions	94
Limiters	50	high-voltage considerations	94
Load resistance	31	humidity considerations	91
Local Oscillator	57	safety considerations	94
Low-Distortion preamplifier	704	screen	10
Low-Voltage and Heater Supply (for Black-and-White TV receiver)	724	structure	11
		X-ray radiation precautions	94

	Page		Page
Picture Tube and Associated Circuits (for Color TV Receiver)	745	Shielding	87
Plate:		Shock-Hazard Warning:	
current	5	picture tubes	94
dissipation	96	receiving tubes	93
efficiency	14	Short-Circuit Test	100
load	22	Shunt Regulator Circuit	69
resistance	13	Signal Generator	734
voltage supply	83	Signal-to-Noise Ratio	54
Plate-Cathode Capacitance	7, 98	Space Charge	6, 9
Power Output:		Static Characteristics	13
calculations	29	Stereo Circuits	686, 700
Power Sensitivity	14	Superheterodyne Receiver (ac/dc)	675
Power Supplies	711	Suppressor Grid (Grid No.3)	8
Preamplifier for Amateur Receiver	688	Sync	64
Preamplifier for Ceramic Phonograph Pickup	704	Sync, AGC, and Vertical-Deflection Circuits	735
Preamplifier for Magnetic Phonograph Pickup	702	Sync Circuits	64
Preamplifier for Tape-Head Pickup	703	Sync Separator	63
Preamplifiers, Phonograph and Tape	43	Synchroguide	75
Pulse Regulator Circuit	70	Synchronous Detection	73
Push-Pull Operation	28, 31		
		Technical Data for Tube Types	111
Q (selectivity)	52	Television:	
Radio-Frequency:		color demodulation	72
amplifier	25, 52	horizontal deflection	66
filter	89	if amplifiers	57
Radio Receiver	15	picture tubes	10, 91, 94
Ratings:		receiver	16
absolute-maximum system	95	rf amplifiers	56
design-center system	95	scanning	83
design-maximum system	95	sync circuits	64
Ratio Detector	24	vertical deflection	68
Rectification	17	Terminal Diagrams:	
Rectifiers:		For Picture Tubes	672
full-wave	5, 17	For Replacement and Discontinued Types	612
half-wave	5, 17	Testing Electron Tubes	100
ionic-heated cathode	6	Tetrode Considerations	7
parallel operation of	18	Three-Stage IF Amplifier/Limiter and Ratio Detector	682
plate-characteristics curves	98	Tone-Control Amplifier Stage	733
voltage doubler	18	Tone Control	45
Relaxation Oscillator	75	Transconductance:	
Remote-Cutoff Tubes	27	conversion	14
Resistance-Coupled Amplifiers	26, 641	grid-plate	14
Resistance Coupling	26	test	101
Resistor:		Triode Considerations	7
cathode (self-biasing)	84	Tube:	
center tap	82	outlines	633
filament	82	ratings, interpretation of	95
plate load	31	tester requirements	103
screen-grid	85, 99	Tube Types, Technical Data	112
Resonant Circuits	52	Tuned Amplifiers	52
Safety Precautions:		Tuner, FM	682
picture tubes	94	Tuners, Television	56
receiving tubes	93	Tuning Indicators	79
Saturation Current	6	TV Scanning, Sync, and Deflection	61
Scanning Fundamentals	63	Twin diode-triode	20
Screen Grid (Grid No.2):		Two-Channel Audio Mixer	700
considerations	7	Two-Channel Stereophonic Amplifier	698
input	99	Typical Operation Values, Interpretation of	98
input rating chart	300		
voltage supply	86	Vertical and Horizontal Deflection Circuits and High Voltage Rectifier	720
Secondary Electrons	8, 9	Vertical Deflection	68
Secondary Emission	8	VHF Tuner	740, 755
Selectivity (Q)	52	Video, AGC, and Sync Amplifier	718
Self Bias (cathode bias)	84		

Video Amplifiers	Page 58, 60	by screen-grid-voltage variation	Page 87
Video IF Amplifiers and Sound-Channel Circuits	731	delayed automatic (DAVC)	47
Voltage:		Voltage Doubler	18
amplification, class A	15	Volume Compressor and Expander	50
doubler rectifier	18		
peak heater-cathode	96	Wideband (Video)	
peak inverse plate	97	Amplifiers	58
supply	83		
Volume Control:		X-Ray Radiation Considerations:	
automatic (AVC)	46	picture tubes	94
by grid-voltage variation	85	receiving tubes	93

Other RCA Technical Publications

Field Service Guides for RCA Color-TV Receivers

- ERT-200 Volume - 1 (1955-1966) \$2.00*
- ERT-201 Volume - 2 (1967-1968) \$1.60*
- ERT-202 Volume - 3 (1969-1970) \$1.90*
- ERT-203 Volume - 4 (1971-1972) \$2.90*
- ERT-204 Volume - 5 (1973-1974) \$3.95*



These guides provide up-to-date service information on RCA color-TV chassis. All of the guides are compact enough to fit into your service caddy; however, they open to a full 11" x 17" for clear, easy reference.

Sections include:

- Comprehensive Indexes by Model Number and Model Name
- Step-By-Step Setup Procedures
- Top and Rear Chassis Views
- Easy to Read Schematic Diagrams
- Procedures for Picture Tube Removal and Replacement

Color-TV Service Handbooks For Major Manufacturers

- 1A1759 (1967-1968) \$2.00*
- 1A1848 (1969-1970) \$2.25*
- 1A1973 (1971-1972) \$2.95*
- 1A2092 (1973-1974) \$3.75*



These handbooks permit you to service color-TV receivers of most major manufacturers in the customer's home. Data in these handbooks are based on the original manufacturer's service notes.

The handbooks include manufacturers such as:

Admiral, Airline, Dumont, Curtis Mathes, Emerson, General Electric, Hitachi, Hoffman, Magnavox, Motorola, Olympic, Packard Bell, Panasonic, Philco, RCA, Sony, Sylvania, and Zenith

Sections include:

- Comprehensive Index
- Top Chassis View Showing all Major Components
- Simplified Setup Procedures For Purity, Black-and-White Setup Convergence, and AFPC.

* Prices are net and are subject to change without notice at our discretion.

Solid State Servicing TSG-1673A \$3.95*



Practical bench-oriented service manual covering the application and servicing of solid-state devices (diodes: rectifiers-zeners-varactors; transistors: bipolar-FET's; thyristors: SCR's-triacs; IC's) in Power Supplies, Hi-Fi and Tape-Recorder Amplifiers; AM and FM Receivers (mono and stereo); and Television Receivers (color and black-and-white).

Text sections include:

- Solid-State Operating Principles
- Basic Amplifier Considerations
- Power Supplies
- Hi-Fi and Tape-Recorder Amplifiers
- Radio Receivers (AM and FM – Mono and Stereo)
- Television Receivers (Color and Black-and-White)
- Servicing Solid-State Circuits

Solid-State Hobby Circuits HM-92 \$2.95*



408 pages containing 68 circuits of general interest to all experimenters. Circuits use diodes, transistors, SCR's, triacs, MOS transistors, integrated circuits, and light and heat detectors. Circuit operation is described in detail; construction layouts, photographs, schematic diagrams, and parts lists are given; and full-size drilling or printed-circuit templates are included for most circuits to simplify construction.

Circuits you can build, use, and enjoy.

- Audio
- Automobile
- Home & Hobby
- Musician
- Photographer
- Amateur Radio
- Communications
- Games & Recreation
- DC Power Supplies
- How to Build Electronic Circuits
- How to Test & Troubleshoot Solid-State Devices

* Prices are net and are subject to change without notice at our discretion.

Electro-Optics Handbook EOH-11**\$4.95***

256-page Handbook, a carefully edited collection of technical information from many different widely scattered sources, provides general extensive reference material in the rapidly expanding electro-optics field. Dozens of tables, charts, graphs as well as descriptive text. A fully indexed valuable time-saving reference.



Sections include:

- Radiometric Quantities and Units
- Photometric Quantities, Units, and Standards
- Physical Constants, Angle Conversion Factors, and Commonly Used Units
- Blackbody Radiation
- Eye Response and Luminous Efficacy
- Sources of Radiation
- Atmospheric Transmittance
- Detection, Resolution, and Recognition
- Lasers
- Detector Characteristics
- Image and Camera Tubes
- Optics
- Photographing E-O Displays

Photomultiplier Manual PT-61**\$2.50***

192 pages of technical data and information on photomultiplier construction, operation, and applications for designers and users of electro-optical equipment. Data on sources, spectra, noise, and RCA photomultipliers are included. Well illustrated and well written for easy reading, this manual is valuable to students, engineers, and service technicians.



Sections include:

- Photoemission
- Secondary Emission
- Principles of Photomultiplier Design
- Statistical Fluctuations and Noise
- Applications of Photomultipliers
- Voltage-Divider Considerations
- Photometry
- Radiant Energy and Sources
- Spectrum Response
- Source — Detector Matching

* Prices are net and are subject to change without notice at our discretion.

RCA Products for the Technical Service Industry

Receiving tubes
Receiving-type industrial tubes
Color picture tubes
Black-and-white picture tubes
Power tubes
Electro-optic devices
Replacement semiconductor devices
Batteries
Test equipment
Antennas
Antenna rotators
Antenna installation hardware
Reception aids
Spray chemicals for electronic equipment
Servicing aids
Industry compatible test jigs
Exact replacement parts for RCA products
Film resistors (flameproof)
Car radios and tape players
Speakers
Scanning radios

See your RCA Distributor – or, for more information contact:

**RCA | Distributor and Special Products Division |
Cherry Hill Offices | Camden, N.J. 08101**



RCA Distributor and Special Products Division